

Goodmans

GFMTDAB10

In-Car DAB Adaptor

User Guide

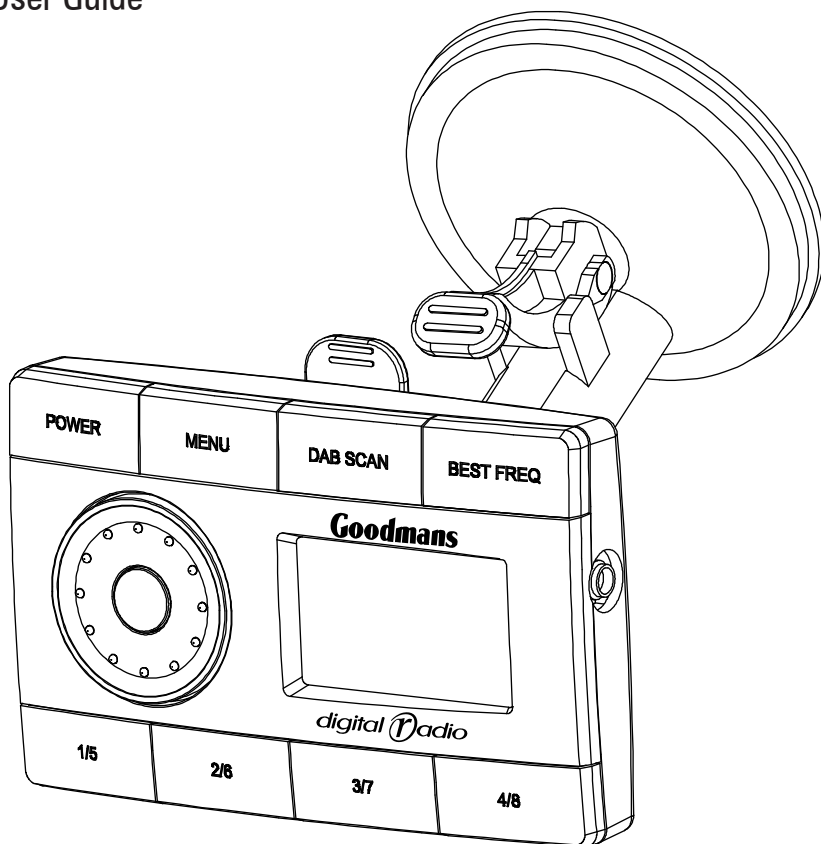

IMPORTANT: Please read all instructions carefully before use and keep for future use

Introduction

Thank you for purchasing this Goodmans In Car DAB Adaptor.

Not only does it receive DAB radio stations and transmit them to your In Car Audio system using an in-built FM transmitter, you can also connect an auxiliary device to it.

Safety is important

Use of any electrical equipment should be undertaken with care. Please read the safety section on page 14 before using this In Car DAB Adaptor.

What's in the box

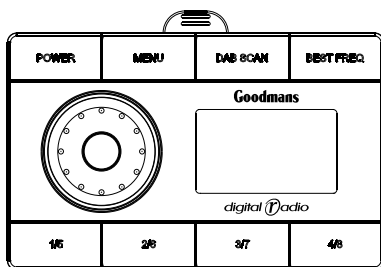

DAB Transmitter

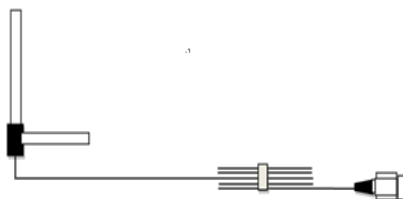

Antenna

"The antenna shown may differ slightly to the one supplied"

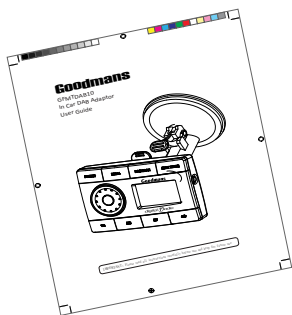

Manual

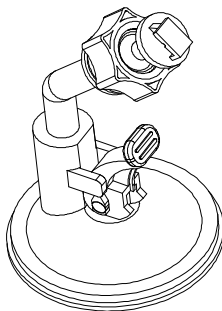

Windscreen Mount

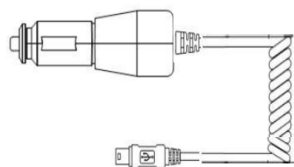

12/24V- 5V DC In Car Adaptor

Contents

01	Your In-Car DAB adaptor	4
02	Get Going	5
03	Daily Use	7
04	Troubleshooting Guide	12
05	Specifications	13
06	Warnings	14
07	Guarantee	15

01 Your In Car DAB Adaptor

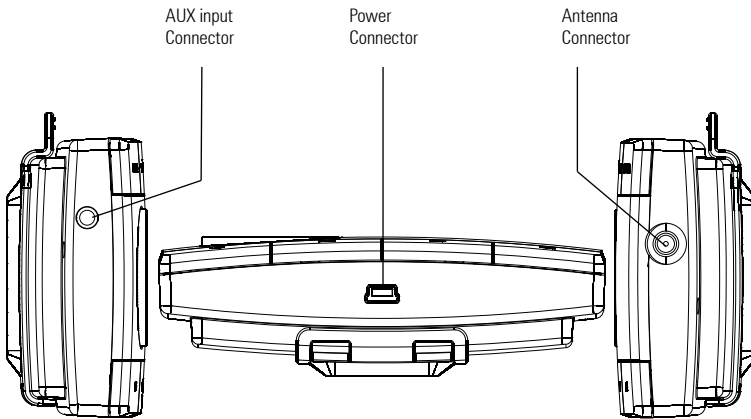
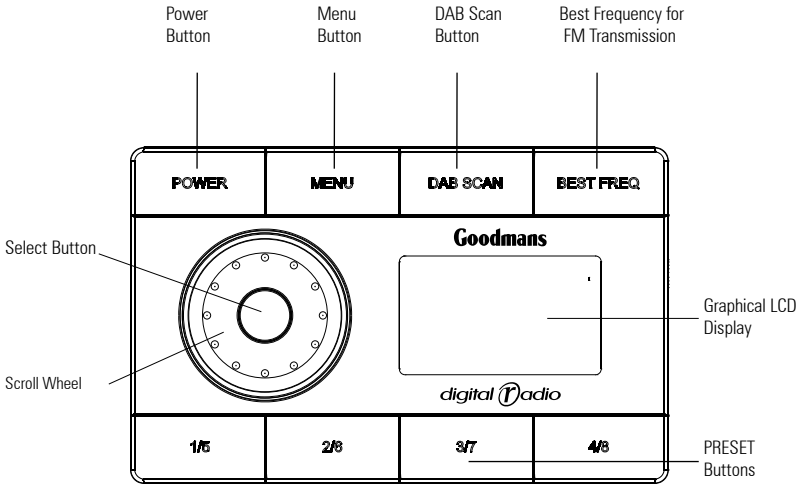

1 Install the Antenna

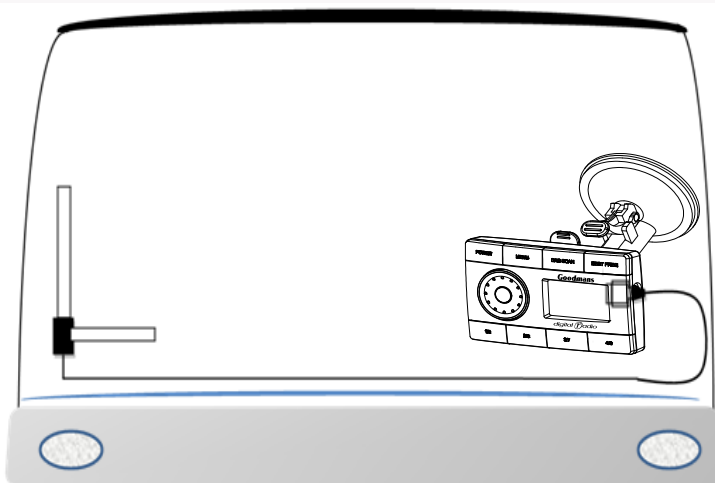

Select a suitable location for the antenna. This can either be at one side of the front windscreen, as shown, or a suitable non-opening rear window. Note that the antenna cable is 2.0m in length. For best results, position the aerial wires 2-3 cms from the edge of the glass.

Peel the backing off the antenna and attach the antenna to the inside of the window, ensuring it is clean and dry before you do so. It is only designed to be used once, and if removed, will not re-adhere to the glass.

2 Connect the Antenna

Run the antenna lead along the trim so it is not showing if possible, and attach to the unit by screwing the antenna connector onto the antenna jack on the side of the unit. Screw it up tightly using fingers only.

Don't Forget! A spanner is not necessary.

3 Attach mount to the windscreen

Clean the area you have chosen with a dry cloth then peel off the transparent film from the suction cap. Press the suction cap firmly onto the windscreen and push down the catch to securely fasten the mount to the windscreen.

02 Get Going

4 Attach the unit to the mount

Slide the clip on the back of the unit onto the windscreen mount. Adjust the mount for the best view of the unit.

5 Attach the Power cable

The power cable is a miniature USB socket on the bottom of the unit. Attach one end to the unit and plug the other end into a 12 volt lighter socket.

When the unit powers up for the first time, or after a factory RESET, it will perform a full scan for DAB stations after displaying the best FM frequency. Tune your car radio to the frequency shown.

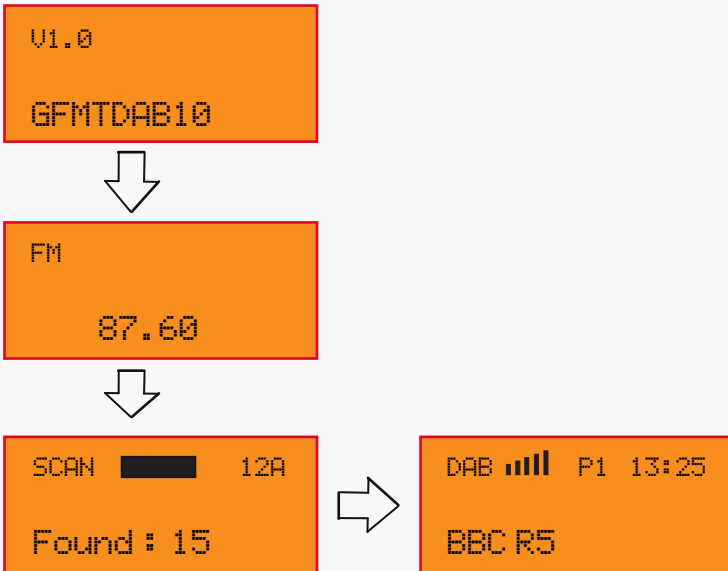

If there are no DAB stations within range, the display will show:



Switching On

When the unit is plugged into the car supply it switches on automatically.

Listening to DAB

- 1 If no DAB stations have been previously stored, the unit will perform a full scan. The following screen will be displayed. A bar graph indicates the progress of the scan – the number of stations increasing as the scan progresses.

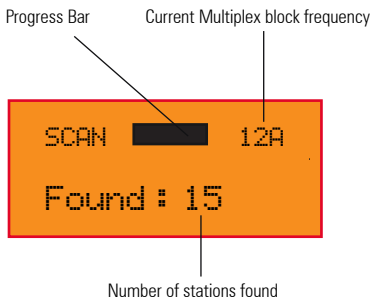

- 2 When the scan is complete, the unit will select the first station available - stations are listed in numeric then alphabetic order. The station list is retained in the unit's memory so that next time you use the unit it does not perform a station scan, but selects the last station you listened to. If there are no stations found, check that DAB coverage exists in the area you are in.

Changing DAB stations

Rotate the scroll wheel to scroll through the stations in the station list. Press the SELECT button to confirm. The unit will tune to the new station.

DON'T FORGET! If no new station is selected the unit will display the currently playing stations after 5 seconds. From time to time, and as you travel around, new DAB stations may become available. If you wish to see if any new stations are available, perform a DAB scan.

DAB Scan

The DAB SCAN button enables the unit to perform a full or a UK scan. A short press performs a UK scan (Channels 10A to 12D) and a long press performs a full Band III scan (Channels 5A to 13F)

03 Daily Use

Storing DAB Presets

- 1 You can pre-set up to 8 DAB stations for easy access as follows. Tune to the station you wish to preset.



- 2 Press and Hold the Preset Button 1 to 4. The screen will display "STORED."



- 3 To store presets 5 to 8, after tuning to the station you wish to store, press the SELECT button which acts as a shift function.



- 4 Then press and hold the preset button 5 to 8

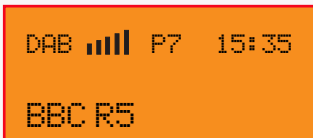

Selecting a Preset Station

- 1 Briefly press the preset button 1-4. The station previously stored will be selected and played.



- 2 To select preset 5 – 8, first press the SELECT button.



- 3 Then briefly press PRESET button 5 – 8.

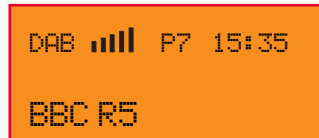

DON'T FORGET! If you select a preset location that has not been programmed with a station, "Empty" will be displayed.

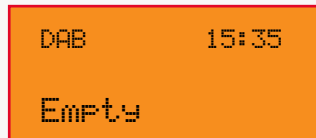

Changing the DAB station Information

It is possible to change the information displayed on the second line of the display when listening to a DAB station. There are 6 different types of information available as listed below: They are selected by pressing the menu button.

- 1 Station Name – Normally Displayed.



- 4 Press again for FM Transmitter Frequency.



- 2 Press the menu button once for Multiplex name.



- 5 Press Again for backlight. There are 3 options for backlight. ON (default setting), OFF and 10 seconds.



- 3 Press again for Programme Type (PTY).

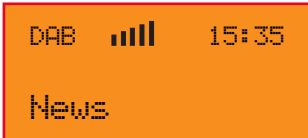

Press again for RESET

To perform a factory reset, press the Menu button until the RESET screen shown below appears, then press the SELECT button. If you do not wish to RESET the unit, wait for 5 seconds and the menu will time out returning to the now playing screen.



DON'T FORGET! If you perform a Factory Reset all the stations in the station list will be removed, and all the presets will be cleared. After the RESET the unit will perform a Full DAB scan.

03 Daily Use

AUX Function

To listen to an external music source instead of DAB, connect an audio cable to the AUX IN socket on the side of the DAB Adaptor. Then press and hold the MENU button.



AUX
AUX IN

To return to DAB mode, press and hold the MENU button once more.

BEST FREQUENCY Function

The unit will automatically scan and select the best frequency for the built in FM transmitter for the first time of use and after a factory reset . To select a new FM frequency if the current one causes hissing or crackling in the background, press the BEST FREQ button once to display the current FM frequency.



DAB  15:35
87.60

and once again to select and display a new frequency. Then re-tune your car radio to the new frequency. After 5 seconds the display will revert to the now playing display.



DAB  15:35
107.80

Best Frequency can also be manually set using in steps of 10 MHz using the scroll wheel.

Power ON/OFF

The unit can be turned on and off using the POWER button. To turn the unit off, press and hold the POWER button for 3 seconds. The display will show "SHUTDOWN".



To turn the unit on, press and hold the POWER button. The unit will start up by displaying the start-up screen which includes the software version number on the top left of the display.

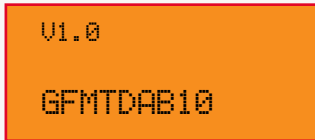

RDS Display

The unit not only transmits audio to your car radio using the built in FM transmitter, but also sends additional information to the display on your car radio using RDS. If your car radio has RDS (for example, it displays the name of the station rather than just the FM frequency) then the unit will display the name of the DAB station on your car radio. If you are listening to audio plugged into the AUX socket, then the car radio will display AUX IN. Please note that it takes about 4 seconds for the car radio RDS display to change, so during this period the information displayed may be out of date.

DON'T FORGET! Some car radio head units have a very sophisticated database stored which might mean that some DAB station names are not correctly displayed. In this case the unit will display a previously listened to station name. This is not a fault, but due to the way some head units operate.

04 Troubleshooting Guide

PROBLEM	POSSIBLE CAUSE	REMEDY
Hissing noise or crackling in the background	The FM frequency being used already has a station on or close to it.	Press the BEST FREQ button to select a new FM frequency and re-tune the car radio to the new frequency.
DAB station cannot be heard	Car Radio not tuned to the correct FM Frequency	Press the BEST FREQ button once to display the FM frequency and re-tune the car radio.
	DAB signal very weak	Use the SCAN button to scan for DAB stations available in your area.
	Unit is in AUX mode	Press and hold the AUX button to return to DAB mode

Need extra help?

Don't worry we are just at the other end of the phone. If you are experiencing problems using your new product, before returning it to the retailer, just call 0871 230 1777.

Need a spare part?

If you need a spare part, please contact our spares department on: 0871 230 0790

In-car DAB radio adapter with full DAB Band III reception. Compliant with ETS 300 401 and capable of decoding all DAB transmission modes 1-4.

Frequency range	DAB Band III 174 - 240 MHz.
FM transmit range	87.5 – 108.0 MHz.
Input connectors	5V mini USB DC power connector 3.5mm line in, 2.0mm antenna connector
Presets	8 DAB station presets
LCD display	Orange backlit graphics LCD display
In-car power supply	12-24V DC to 5V DC (0.5A) mini USB power adapter.
Power consumption	5V, DAB Mode : 80mA ~ 120mA
Dimensions	104 mm wide, 65 mm tall, 34 mm deep
Weight	78 g

IMPORTANT: Due to continual revision and improvements to our products design, specifications are subject to change without notice.

WEEE

This appliance is labelled in accordance with European Directive 2002/96/EG concerning used electrical and electronic appliances (Waste Electrical and Electronic Equipment - WEEE).

The guideline determines the framework for the return and recycling of used appliances.

Sound levels

Your hearing is very important to you and to us, so please take care when using this DAB Radio.

It is strongly recommended that you follow the listed guidelines in order to prevent possible damage or loss of hearing.

Establish a safe sound level

Over time your hearing will adapt to continuous loud sounds and will give the impression that the volume has in fact been reduced. What seems normal to you may in fact be harmful. To guard against this **before your hearing adapts**, set the volume to a low level.

Slowly increase the level until you can hear comfortably and clearly and without distortion. Damage to your hearing is accumulative and is irreversible. Any ringing or discomfort in the ears indicates that the volume is too loud.

Once you have established a comfortable listening level, **do not increase the sound level**.

General Safety

This DAB Radio has been designed and manufactured to meet European safety standards, but like any electrical equipment, care must be taken if you are to obtain the best results and safety is to be assured.

Do read these operating instructions before you attempt to use the DAB Radio.

Do ensure that all electrical connections (including extension leads and interconnections between pieces of equipment) are properly made in accordance with the manufacturer's instructions.

Switch off and remove the power plug when making or changing any connections.

Do consult your dealer if you are ever in doubt about the installation, operation or safety of your DAB Radio.

Don't continue to operate the DAB Radio if you are ever in doubt about it working normally, or if it is damaged in any way. Switch it off, withdraw the power plug and consult your dealer.

Don't remove any fixed covers as this may expose you to dangerous voltages.

Don't leave the DAB Radio switched On when it is unattended for long periods of time, unless it is specifically stated that it is designed for unattended operation or has a standby mode.

Don't obstruct the ventilation vents on the DAB Radio, for example with curtains or soft furnishings.

Overheating will cause damage and shorten the life of the product.

Don't allow electrical equipment to be exposed to rain or moisture.

The DAB Radio is guaranteed for twelve months from the date of original purchase. If there are any defects due to faulty materials or workmanship, contact the Goodmans Helpline. Have your receipt of purchase on hand.

The guarantee is subject to the following provisions:

- It is only valid within the boundaries of the country of purchase.
- The product must be correctly installed and operated in accordance with the instructions contained in this User Guide.
- The DAB Radio must be used solely for domestic purposes.
- The guarantee will be rendered invalid if the DAB Radio is re-sold or has been damaged by inexpert repair.
- The manufacturer disclaims any liability for incidental or consequential damages.

Goodmans

Helpline 0871 230 1777

www.thesupportsite.co.uk

Download from Www.Somanuals.com. All Manuals Search And Download.

Free Manuals Download Website

<http://myh66.com>

<http://usermanuals.us>

<http://www.somanuals.com>

<http://www.4manuals.cc>

<http://www.manual-lib.com>

<http://www.404manual.com>

<http://www.luxmanual.com>

<http://aubethermostatmanual.com>

Golf course search by state

<http://golfingnear.com>

Email search by domain

<http://emailbydomain.com>

Auto manuals search

<http://auto.somanuals.com>

TV manuals search

<http://tv.somanuals.com>