



USER'S MANUAL



EV Rider, LLC
6410 Arc Way • Suite A • Fort Myers • FL 33966
www.evrider.com • 1.800.944.1997

IMPORTANT SAFETY NOTICE

It is important to read and follow all the instructions and safety information contained in this Owner's Manual prior to use.

- Always wear a safety helmet (which is provided with each SNR scooter).
- Do not operate at night.
- Comply with all local laws and regulations.
- Do not use in wet conditions.
- Do not use off road. This device is designed for hard surfaces only.
- Recommended for riders 16 years of age or older.
- Check all take-apart locks before each use.
- Ensure battery pack is properly charged before use.
- Using the half-speed mode, practice in a large, open area, free of vehicles, obstacles and pedestrians.
- Do not use the full-speed mode when using the scooter with the optional seat.
- Send your warranty registration card as soon as possible.

TABLE OF CONTENTS

	PAGE
Important Safety Information	3
General Information	3
Riding Terrain	3
Mechanical Systems	4
About the Batteries	4
Additional Safety Information	5
Stand N Ride Overview Diagram	6
Assembly Instructions	7
Tiller Assembly	7
Base Frame Assembly	7
Installing the Optional Seat Assembly	8
Coupling the Tiller to the Base Frame	9
Installing the Battery Pack	9
Before You Ride Checklist	10
How to Ride the Stand N Ride	10
Battery System and Charger	11
Basic Maintenance	12
Trouble Shooting	12
Specifications	13
Warranty Information	14

IMPORTANT SAFETY INFORMATION

It is important to read and follow the instructions and the safety information contained within this owner's manual prior to use.

General Information

The SNR is a recreational battery-operated vehicle. It is not a mobility device for medically prescribed use and should not be used as such.

Always wear a helmet when riding the SNR. For your convenience and safety, EV Rider provides a helmet with each SNR scooter.

This product is not recommended for users younger than 16 years old.

Operators must comply with local laws and regulations. Check with your local Police Department or the Dept. of Motor Vehicles to determine your local requirements with respect to the SNR.

SNR scooters require skill to operate safely. Practice starting, stopping and turning in a large open area, free of vehicles, obstacles and pedestrians.

Do not operate the SNR at night. The SNR is not equipped to be operated outdoors at night or in low light conditions. It may not be visible to other vehicles or pedestrians in these conditions.

Do not operate the vehicle near children. When approaching pedestrians, announce your presence to minimize sudden, unexpected moves by pedestrians.

This product is designed to be used only by one rider. Do not carry any additional people. Do not carry any items on the SNR unless they are securely placed in the basket.

Do not tow or pull the SNR electric scooter behind a vehicle, bicycle or pedestrian.

Do not use the SNR to tow or pull anything.

Riding Terrain

Ride only on smooth, hard, flat surfaces. The SNR is not intended for off-road or hilly terrain conditions.

Use caution when approaching curbs, uneven pavement, potholes or similar conditions. The wheels are not intended to go over more than 3" obstacles. You may fall when running over these obstacles.

Do not ride the Stand N Ride downhill for extended periods of time. This may increase the wear of the brake lining and adversely affect the ability to stop the unit.

Mechanical Systems

Check all joints, hinges and quick releases to ensure that the Stand N Ride is properly assembled. Stop using the product immediately if any joint, hinge or quick release becomes loose. Re-tighten the joint, hinge or quick release prior to resuming the ride.

The electric motor, batteries and controls can get damaged if exposed to water. Do not use the Stand N Ride in the rain and do not drive through water puddles.

If the brake lever touches the handle bar grip, stop using the unit until the brake lever is adjusted or replaced.

About the Batteries

The batteries (two 18 Ah batteries) are contained in the battery box, which also houses a circuit breaker and the charger port.

While the batteries are charged before shipping from the manufacturer, we recommend that you charge the batteries fully before the first use (at least 4 hours).

Use caution when recharging the batteries. Do not charge the batteries in an area prone to becoming wet.

Recharge the batteries only in an area that is well ventilated.

Keep children away from the Stand N Ride while it is being recharged.

Do not use an extension cord to plug the charger to the wall outlet.

Stop using the charger if the power cord or the charger connector (XLR connector) becomes worn, broken or damaged in any way. Have the product inspected and repaired by an authorized/qualified dealer.

Do not modify the electrical controls or wiring. Any attempt to do this may result in injury and will void the warranty immediately. Use only motors, batteries and charging units supplied or approved for the Stand N Ride scooter.

Do not use the Stand N Ride batteries to power any other battery-operated equipment.

Additional Safety Information

Adjust the handle bar height to provide a comfortable and secure riding position on the Stand N Ride scooter. The rider's hands should be able to easily grasp the handle bar controls (throttle and brake lever). They should not be higher than the waist or lower to ensure proper posture and riding control of the unit.

If using the seat option, the handle bar should be lower to compensate for the seating height of the user. The seat height should be such that both feet should rest on the floorboard comfortably and the hands must be able to grasp the handle bar controls.

Handle bar and seat height positions should be locked and tightened.

When finished riding the Stand N Ride scooter, remove the key and take it with you. This prevents unauthorized use of the product, especially by children.

After taking the product apart for transportation, be certain to protect the handle bar controls from accidental damage and make sure that you balance the components, particularly on stairs to avoid falls.

If service is necessary, contact your authorized Stand N Ride electric scooter service. Do not attempt to service the electric scooter yourself. Service by anyone other than an authorized service center will void the product's warranty.

For service information call 1-800-944-1997 or visit our website at www.evrider.com.

Stand N Ride Overview

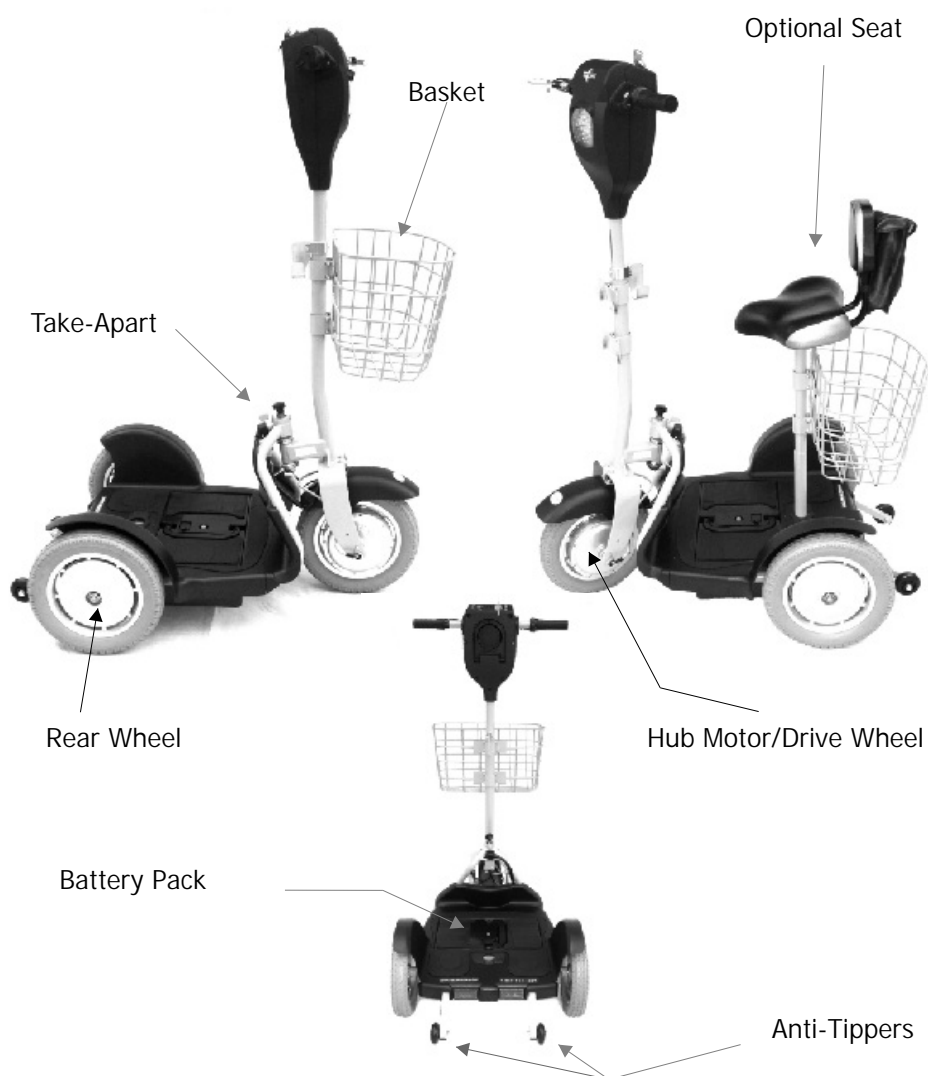
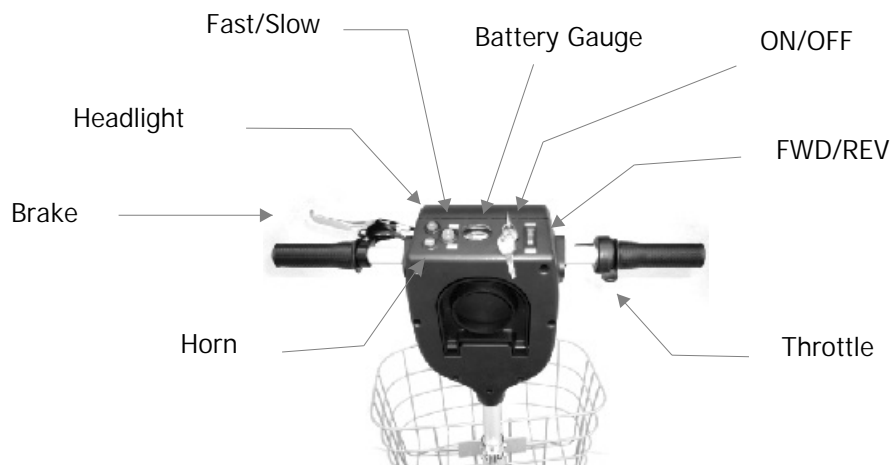

Assembly Instructions

Your Stand N Ride is shipped in two boxes: 1 containing the tiller and 1 containing the base frame.

After you have removed the Stand N Ride components from the protective packaging, you are ready to set up your scooter for riding by following these steps:

Tiller Assembly:

- Loosen the tiller height lock to allow for the insertion of the upper portion of the tiller/handle bar (Fig 1 and Fig 2).
- Making sure that the main wire harness and the brake cable are not caught by the tubing, insert the upper tiller section and slide it to your desired height. Fasten the center guide screw so the tiller stays centered and then lock it in place by tightening the collar lock with the Allen key provided. You can always loosen it and re-adjust the height if your initial height is not comfortable.
- Make sure that the tiller is centered and securely fastened before you move to the next step.

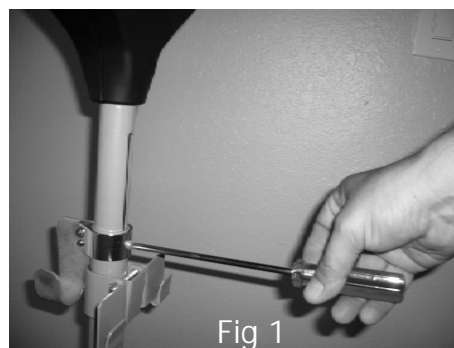

Base Frame Assembly:

Remove the battery pack from the main base component to ease the task of installing the wheels.

- Slide a washer on the rear wheel shaft (Fig 3).
- Now install the wheel followed by the other washer and the Nylock nut. Tighten it by hand.
- Repeat the process on the other side for the remaining wheel.
- Using a 22 mm wrench (or a 7/8 wrench), tighten the nut to secure the wheels in place. DO NOT over-tighten the nut and make sure that the wheel turns freely but is securely fastened to the shaft (Fig 4).
- Repeat the process for the other side.



Installing the Optional Seat Assembly:

Locate all the seat assembly components and have them at hand to begin the installation of the seat assembly (Fig 5).

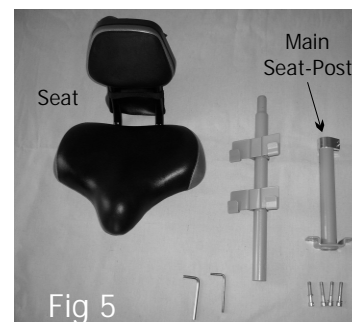

- Remove the seat-post locking collar from the main seat-post tube to allow insertion of the tube through the base frame from the bottom up (fig 6).

- Flip the base over to the side and insert the main seat-post tube. Make sure that the adjustment holes face the left wheel, otherwise you may end up with the basket brackets facing the front of the scooter, which is not appropriate (Fig 7). Fasten the 4 Allen bolts to the base frame and tighten them very well using the Allen key provided. Make sure that you do not forget to slide a pressure nut into every bolt before affixing it to the base frame.

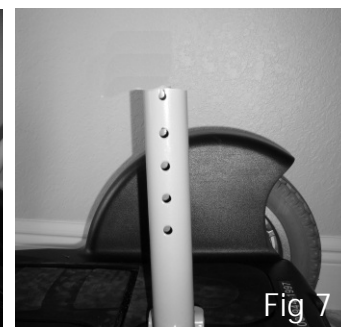
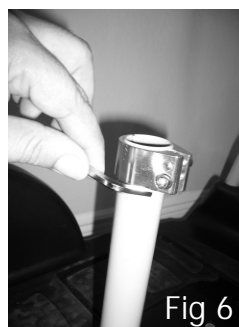

- Flip the base frame over and re-install the locking seat-post locking collar. Do not tighten yet. This will have to be done after you have inserted the seat assembly and once you select your desired seat height.

- Making sure that the basket brackets face towards the rear of the seat (backrest), insert the adjustable, removable seat-post tube into the seat base receiver. Tighten the nut and bolt (Fig 8).



- Insert the seat assembly onto the receiver seat-post (Fig 9) and select your desired seat height.

- DO NOT forget to lock the seat-post collar (Fig 10) now!

You are now ready to couple the tiller and the base frame together.

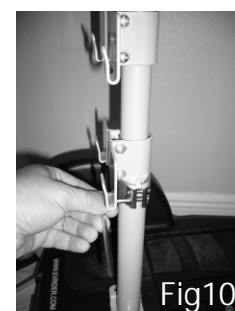

Coupling the Tiller to the Base Frame:

- Remove the secondary safety knob from the tiller coupler pin to allow the pin to slide through the base frame receiver.
- Align the tiller coupler pin with the base receiver tube and slide it over the tiller pin (Fig 11). Wiggle it lightly until the locking spring locks in place. The wire connector would have locked itself in place at the same time.
- Make sure that the connection is secure by deflecting the spring lock and verifying that it rests on the groove of the tiller pin (Fig 12). This is an indication that the connection is secured.
- Attach the secondary safety knob and tighten it (Fig 13).

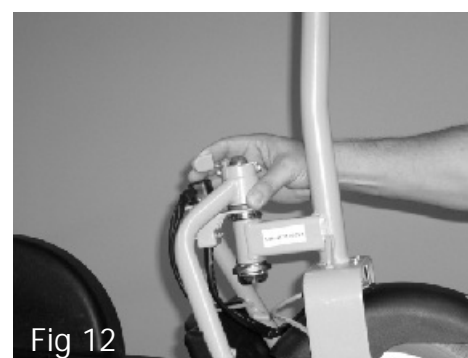

Installing the Battery Pack:

- With the battery connector at the bottom of the battery box facing forward (towards the front wheel), slide the battery pack onto the battery housing (Fig 14) until the top of the battery pack lines itself up with the floorboard.
- Turn the ignition key to the ON position and tap the horn button to verify the connection.

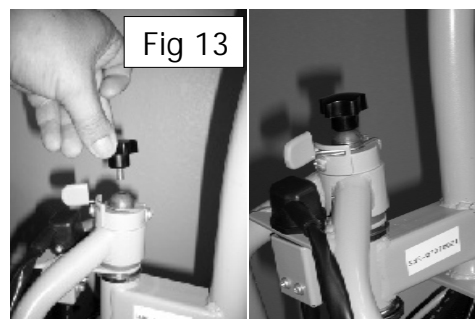

You are now ready to test your Stand N Ride!



Before You Ride Checklist

Before riding the Stand N Ride electric scooter, be sure to carefully follow the checklist below:

- Read and understand the Important Safety information section of your Owner's Manual.
- Make sure that the battery pack has been fully charged.
- Check that the battery pack connection to the base frame is tight.
- Check that the tiller and the base unit components are securely connected and that the secondary safety knob is in place and securely fastened.
- Make sure that the handle bars height (and the seat height if you are using this option) are adjusted to your preference .
- Carefully check all joints, quick release levers, locking buttons and latches to ensure each is secured.
- Check that your tires are properly inflated if not fitted with the flat-free option.
- Check the brake lever for proper function.
- Most importantly, make sure to have your helmet ready to be worn.

How to ride the Stand N Ride Scooter

It is important that you understand how to operate the scooter, so carefully follow these steps:

1. Mount the unit and position yourself behind the handle bars with your feet resting on the floorboard.
2. Check that the brake is not locked. Squeeze it to disengage it if it were locked.
3. Turn the key to ON position (clockwise).
4. Check to see if the battery gauge is in the green zone.
5. Make sure that the speed direction switch (FWD/REV) is set to go forward or reverse depending on the direction that you want to go to.
6. Select the speed setting (Fast or Half Speed) as desired. We recommend that you begin using the Stand N Ride scooter only in half speed until you get acquainted with

the unit and become proficient riding it.

7. Gradually apply the throttle until the desired speed is achieved. Once again, we recommend that you do not venture to full speed operation until you have become proficient with the scooter and only if you are certain that there are no obstacles in site on an open field.
8. Make sure to slow down your speed while turning and balance your weight to the opposite side of the turns to ensure the unit's stability.

IMPORTANT NOTICE: The Stand N Ride's microcomputer (controller) automatically cuts off power to the motor whenever the brake is applied. the motor regains power after a short pause after releasing of the brake. Likewise, if the brake is set to the lock position, drive is disabled. Make sure to release the brake before you apply the throttle.

If you are using the seat option, we strongly recommend that you do not use the FAST speed setting.

Battery system and Charger

Warning: Only use the battery charging unit that was supplied with your Stand N Ride scooter. Use of any other battery charging unit or equipment voids your warranty and may result in severe damage to the battery pack and the scooter and may cause a fire hazard. Always wait until the battery gauge shows at least half charge to recharge the batteries. Overcharging may result in decreased battery life.

The battery pack can be recharged either while in the Stand N Ride or when removed. To charge the battery pack:

1. Remove the battery charger port cover (Fig 15).
2. Plug the XLR connector to the charger port (Fig 16).
3. Plug the charger plug to the wall outlet.

When charging, the charger's LED should show any of the following colors:

RED shows that the charger is plugged to the wall, but not to the unit.

AMBER shows that the charger is charging the batteries

GREEN shows that the charger has finished charging the batteries or that the batteries are full and do not need charging.



Fig 15



Fig 16

Basic Maintenance

The Stand N Ride has been designed to provide years of trouble-free riding enjoyment, provided that the user takes care of it by not leaving it exposed to the elements, neglecting to charge it or by using it in any way that is not recommended.

Due to the Stand N Ride's modular design, there are virtually no user serviceable parts. Attempting to service or modify any of the scooter's internal components may result in permanent damage to the scooter and will void the warranty. For service and repair, contact your nearest EV Rider dealer.

It is always best to check before each ride the condition of the cables, brakes and folding latches to ensure their proper settings and tightness.

Occasionally lubricate exposed latches, cables and fittings to keep proper function.

Trouble Shooting

Below are tips on how to handle technical situations that you may encounter:

PROBLEM	PROBABLE CAUSE(S)
The key is turned to the ON position, but there is no drive.	<ol style="list-style-type: none"> 1. The battery pack may not be fully engaged. Check that the floorboard and the top of the battery pack are at level with each other. 2. The battery charge may be too low to drive and may need charging.
The key is turned to the ON position, the batteries are fully charged and the brake lever is not locked.	<ol style="list-style-type: none"> 1. You probably have the charger plugged to the unit or to the unit and the wall. The controller disables drive if it detects the charger connected to the unit.
The key is turned to the ON position, the battery gauge shows charge, but there is no drive.	<ol style="list-style-type: none"> 1. The brake may be engaged, which disables the controller. Depress and unlock the brake.
The tiller/base frame coupler doesn't lock in place.	<ol style="list-style-type: none"> 1. The power connector is probably not aligned to allow for the tube to slide over the pin completely. Make sure that this is aligned and fully connected.
The unit takes too long to brake and it doesn't brake completely.	<ol style="list-style-type: none"> 1. The brake needs adjusting. Rotate the brake cable adjuster away from the brake lever.
The unit drives, but stops after a while.	<ol style="list-style-type: none"> 1. The battery charge may be low. Charge the batteries until full charge is shown. 2. One of both of the batteries may be bad. Have the batteries tested with a load tester to determine if they hold charge.
The scooter drives, but suddenly stops during riding.	<ol style="list-style-type: none"> 1. The batteries are probably low. 2. An over load current was detected by the controller. 3. Overheat condition detected by the controller

SPECIFICATIONS

Model number	SNR-1000
Color	Black Textured ABS Plastic & Metallic Silver Frame
Overall length	992 mm / 36.3 in
Overall width	642 mm / 25.3 in
Ground clearance	75 mm / 3 in
Weight capacity	136kg / 300 lb

Component Weights:

Base	(With optional flat-free tires) 19.8 kg / 43.5 lb
Tiller	18.42 kg / 40.5 lb
Battery Pack	12.59 kg / 27.7 lb
Seat & Charger	5.85 kg / 11 lb
Total	56.66 kg / 122.7 lb

Top speed	24 km/h / 15 mph
Motor type	Brushless DC hub motor, 24V, 500W
Tire size	12.5" X 2.25" Pneumatic Optional flat-free
Battery type	12V - 18 AH
Charger	2A Off Board
Optional Seat type	Oversized bicycle base with built-in backrest

Important Notice: Dimensions and specifications are subject to change without prior notice.

WARRANTY TERMS

ONE-YEAR LIMITED WARRANTY

One year on all structural frame components; including tiller, base frame and seat post (if purchased with this option).

From one (1) year from the date of purchase, if any part or electronic component of the Scooter is found upon examination to be defective in material and/or workmanship, it will be repaired or replaced, at EV Rider's option, without charge. Labor charges are not provided under warranty.

The purchaser is responsible for the delivery to the authorized repair facility. Satisfactory proof of purchase, serial number and the date of purchase are always required. For warranty service, please contact the retail establishment from whom you purchased your EV Rider product.

ONE-YEAR WARRANTY EXCEPTIONS

Motor: In cases where there is an increase in the operational noise level, the warranty does not apply. (The increase in operational noise level usually occurs due to abusive and excessive strain on the scooter.)

The battery is warranted by EV Rider for 6 months after the purchase of the product.

Warranty service can be performed by EV Rider or by an authorized EV Rider service facility. Do not return faulty parts to EV Rider without prior consent. All transportation costs and shipping damage incurred while submitting parts for repair or replacement are the responsibility of the original purchaser.

WARRANTY EXCLUSIONS:

This warranty is only given to the original purchaser of the Scooter. The Warranty excludes:

- Consumable items which may need replacing due to normal wear and tear (tires, tubes, belts, bulbs, upholstery and seating, motor brushes, fuses, plastic shrouds and footrest covers, etc.)
- Damaged caused by: battery fluid spillage or leakage, abuse, misuse, accident, or negligence, improper operation, excessive loading, maintenance, or storage, commercial use or use other than normal.
- Used other than for the purpose of the purchaser's mobility.
- Repairs and/or modifications made to any part of the scooter without specific and prior consent from EV Rider, LLC
- Labor, service calls, shipping, and other charges incurred for repair of the product not expressly approved by EV Rider.

Batteries: Batteries carry a limited warranty which is subject to a stringent wear and tear clause. Any battery faults due to a defect in the original manufacture will normally become obvious within the first two months of use. Any gradual deterioration in performance after this period is normally associated with fair wear and tear, misuse or accidental damage and as such is not covered by the manufacturer's warranty.

There is no other express warranty.

Implied warranties, including those of merchantability and fitness for a particular purpose, are limited to one (1) year from the date of the original purchase and to the extent permitted by law. Any and all implied warranties are excluded. This is the exclusive remedy. Liabilities for consequential damages under any and all warranties are excluded.

NOTES

Free Manuals Download Website

<http://myh66.com>

<http://usermanuals.us>

<http://www.somanuals.com>

<http://www.4manuals.cc>

<http://www.manual-lib.com>

<http://www.404manual.com>

<http://www.luxmanual.com>

<http://aubethermostatmanual.com>

Golf course search by state

<http://golfingnear.com>

Email search by domain

<http://emailbydomain.com>

Auto manuals search

<http://auto.somanuals.com>

TV manuals search

<http://tv.somanuals.com>