



Mini Washing Machine

User's manual

Model: EW-2001MS

- Please read this manual carefully before using.
- Retain it for future reference.



Contents

● Names of the parts.....	1
● Safety precautions.....	2
● Installation and adjustment	4
● Preparation before washing	6
●The musts in washing.....	7
● Usage of the detergent.....	7
● Select the wash time	7
● Finish washing.....	7
● Disposal after washing	8
● Trouble-shooting.....	8
● Packing list *Specification	9

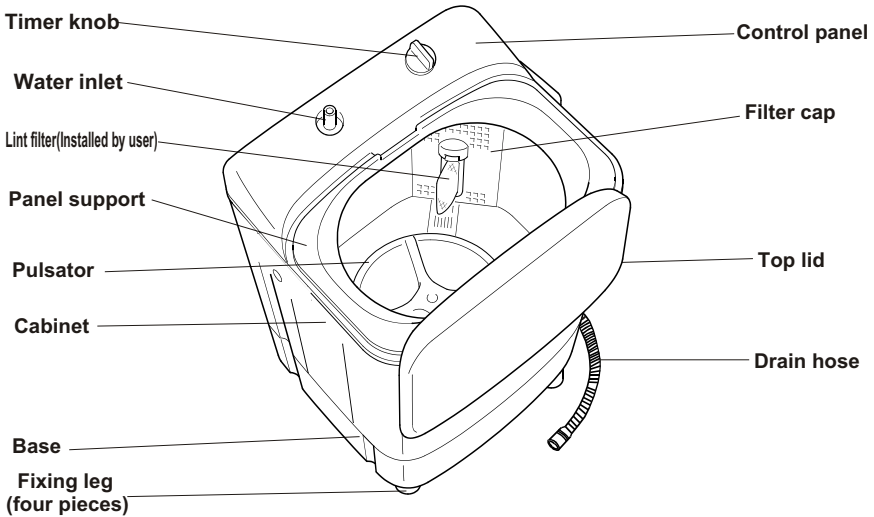
Names of the parts



Meaning and description of the symbols

<p>Warning sign</p> 	<p>Contents marked with that symbol are related to the safety of the product and the personal safety of the users. Please operate in strict conformity to the contents, otherwise it may cause damage of the machine or injure the personal safety of the user.</p>
<p>Forbidding sign</p> 	<p>Contents marked with that symbol are actions forbidden to perform. Performing of those actions may result in damage of the machine or injure the personal safety of the user.</p>

Please check if the power receptacle has good earthing condition before using to guarantee your safety.

Safety precautions

Please insert the power cord into special receptacle with rated voltage. Be sure to use single-phase three pins receptacle. The earthing terminal of the receptacle must be earthed reliably. If possible, please adopt electric leakage protector.



When the machine is normally using, please put the power plug at the location easily to be inserted and extracted by hand. Be sure to pull the plug off when there's power failure, or the machine is being moved, cleaned or when it is idle.



If the power cord is bad, to avoid risk it is required to replace it by the technicians of our special shop or the after-sale service department. Keep the pin of the power plug clean.



Do not put the machine at damp place like the bathroom. Never wash it with water. Do not place wet laundries on the control panel.

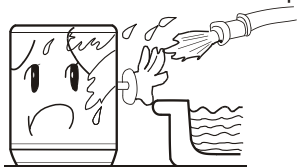

Do not use water hotter than 50°C.



In case the washing machine is installed on ground with carpet, do not block the ventilation hole with carpet.

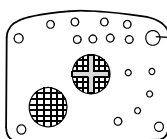

Ventilation hole at the bottom of the washing machine



Do not wash water-proof laundries like the raincoat, bike covers etc. to avoid abnormal vibrations in spinning.



Do not let the machine share one receptacle with other electric appliances. If the power plug is damaged, or the plugging into the receptacle is loose, do not use the plug any more.

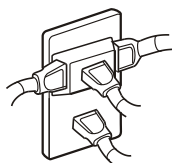

Safety precautions

Do not stretch hands into the working machine. It is dangerous even if the rotation is slow. Take special care of the children.



Do not decompose, repair or alter the machine by yourself.

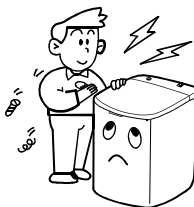

Do not put any hot or heavy items (such as the kettle with hot water) on the washing machine.



Do not wash laundries with volatile materials (such as thinner, petrol etc.).

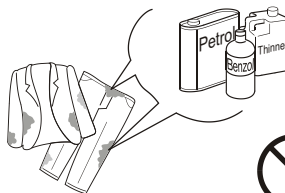

Handicapped or children without care shall not use the machine.

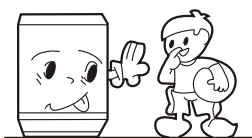

Keep the machine away from direct sunlight and heat source like the heater.



● To protect your laundries and washing machine, please take out all of the coins, buttons, sand, hairpin and other foreign materials before washing.



- Please check if the water faucet is open, and if the connection of the water inlet pipe is proper.
- It is suggested to use foamless washing powder.

Installation and adjustment

Please install and adjust the machine according to the requirement of the manual. It is very important to your security and correct operating the machine.

Usage of the drain hose

When washing, the drain hose must be hung up, if you want to drain, please refer to the below mention.

The drainage shall be smooth with the drain hose.

- 1.The height of the drain hose shall be less than 10cm , or the drainage will not be smooth enough and cause incomplete drainage.

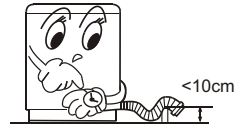

- 2.Do not step on or press the drain hose.



- 3.If extra drain hose is needed , the inner diameter of the extra hose shall not less than 26mm, and the length shall not exceed 1.5m.

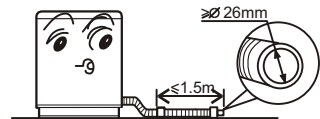

Install the lint filter

After opening the package, please take out the lint filter from the document bag, install it to the filter cap of the cabinet. See to the figure

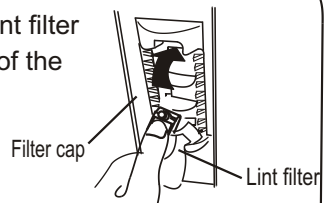

Adjust the installation position

The largest permitted slope of the bearing surface of the washing machine is 2° . Slanting or uneven ground will cause unstable operation of the machine. Please check with following methods:

- Hang a becket with weight to confirm if the washing machine is horizontal.



Install the water inlet hose ; Select the water level

Insert the water inlet hose into the water inlet jointer on the control panel.
(To dismantle the water inlet hose, you only need to pull the hose out.)

Fill the water to the water level selected according to the quantity of the laundries.

Attention:

- Put in the laundries first before water inlet.
- Do not exceed the "Max" water level otherwise the water may overflow out of the machine.
- If the water level exceed the "Max" water level, in order to protect the electrical component, the water flow over to the base from overflow pipe, flow out the washing machine.

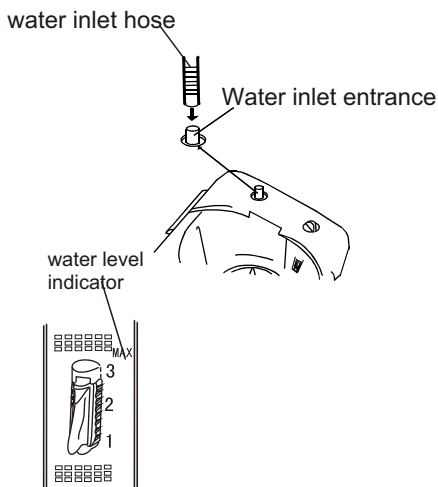

Preparation before washing



Preparation before washing

1. Connect the water inlet hose.
2. Confirm that the washing machine is earthed reliably. Then insert the power plug into the receptacle. Do not connect the earth terminal to the gas pipe and tap water pipe.
3. Hang the drain hose up.



Pay attention to followings before washing the laundries

Check if the laundries has special requirement on washing

Clear the pocket. Take out the coins, sand, hairpins etc.



Tie the long strips; fasten the buttons; close zippers.



The quantity of the laundries shall not be too large. Stretch and loosen the laundries before putting them in the tub.



When the pulsator is running, the buttons of the laundries may cause noise. For the sake of discretion, please put the laundries with buttons into other laundries.



- a. Check if the laundries are applicable for washing with machine.
- b. Divide the laundries that are not colorfast from other laundries.
- c. Put those laundries difficult to absorb water into water with hand.
- d. For those laundries with heavy soil, please first remove the dirt like mud or dust. For the parts with heavy soil, please apply detergent on them in advance, which can make it easier to remove the soil.
- e. For those laundries that may get lint ball and those with long fur, turn it over before putting in.
- f. Do not put those laundries polluted by chemicals into the washing machine directly.

The musts in washing



- The capacity of washing of the machine refer to the largest weight of the standard laundries under dry condition that can be washed in one time. Laundries quantity in one washing cycle shall be lower than the rated capacity.
- The thickness ,size , type of the cloth will influence the actual washing capacity. It is suitable to put in reasonable amount of laundries and the laundries can be turned round in washing for one time washing.

Usage of the detergent

How to use the whitener

- Fill water to decided level. Dilute the whitener with container. Pour it slowly into the washing tub.
- Avoid using whitener on laundries with color or pattern as they are prone to lose color.
- The whitener shall not touch the laundries directly.
- Refer to the user's manual for the usage and quantity of the whitener.
- For powder whitener, please dissolve it before using.

How to use the washing powder

- Direct dissolved in the machine:
 - 1.Fill small quantity of water.
 - 2.Add the powder . Run for 30 seconds to dissolve it completely.
 - 3.Put it in the laundries. Select suitable water level.
- The instant dissolving of the washing powder:
 - 1.Prepare warm water of 30°C and a container.
 - 2.Add the powder while stirring to fully dissolve it.
- The powder is more prone to pollute the laundries than the detergent. Therefore please use it with proper quantity.
- It is suggested not to use high sudsing detergent.
- Dosage of different washing powder is different. Please refer to the instruction of the washing powder for the detail dosage.

Select the wash time

Please select wash time according to the laundries.

Laundries	Wash time (minutes)
Silk(thin laundries)	About2~4
Knitwear/chemical fiber	About3~6
Bed sheet	About7~13
Cotton,blending,linen	About8~10
Very dirty and thick laundries	About10~15

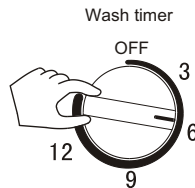

(To set to below 2 minute, first set to 6 minute then turn it back, it can increase the service life of the timer).

Finish washing

- The pulsator stops rotating. Put down the drain hose to discharge the water.



Disposal after washing

- After using, please clean the lint and foreign materials of the lint filter and lint frame in time. Otherwise it may influence your using the machine.
- Please first pull off the power plug from the receptacle before cleaning.

Cleaning the lint filter

- * The lint filter must be used during washing.
- * It must be cleaned in time after each using.

1. Take off the lint filter
Put hand at the indicated position.
Push down to take it off. (See to Figure 1)
2. Clean the lint
Put it in water and clean while it is still wet. (See to Figure 2)
3. Install the lint filter
After cleaning, insert the bottom of the lint filter (marked with "down side") into the filter frame, then push the upper part of the filter in (marked with "up side"). (See to Figure 3)

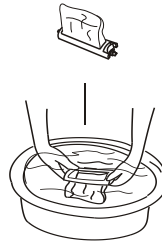

Figure 2



Figure 1



Figure 3

Attention: be sure not to confuse the direction.

- Wipe the complete unit with soft cloth twisted dry.
- Wipe with neutral detergent if too dirty.
- Do not wash it directly by water.







- After washing, dismantle the water inlet hose.
- Pull off the power plug and hang up the power cord.
- Do not store water in the tub for long period. Discharge the water immediately after each using.
- Wipe off the water drops on the surface and inside the tub with clean soft cloth. Open the cover of the wash tub for some time (about one hour), then close it.
- Hang up the drain hose.

Trouble-shooting

The following phenomena are not breakdowns sometimes. Please confirm again before sending it to repair.

Phenomena	How to check
The washing machine does not act	<ul style="list-style-type: none"> ● Is there power failure? ● Is the power plug inserted tightly?
There's abnormal sound inside the machine.	<ul style="list-style-type: none"> ● Is the machine slanting? ● Is there metal item inside the tub?

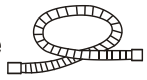
Packing list

Name	Quantity
● User's manual	● One piece
● Warranty card	● One piece
● Filtrate cover 	● One piece
● Water tub 	● One piece
● Water inlet hose 	● One piece
● Lint filter 	● One piece
● Mini Washing Machine	● One set

Specification

Water level/Water quantity (about)	1/7L 2/12L 3/18L
Injection pressure(MPa)	0.02~0.2
Rated washing capacity(kg)	2.0

Free Manuals Download Website

<http://myh66.com>

<http://usermanuals.us>

<http://www.somanuals.com>

<http://www.4manuals.cc>

<http://www.manual-lib.com>

<http://www.404manual.com>

<http://www.luxmanual.com>

<http://aubethermostatmanual.com>

Golf course search by state

<http://golfingnear.com>

Email search by domain

<http://emailbydomain.com>

Auto manuals search

<http://auto.somanuals.com>

TV manuals search

<http://tv.somanuals.com>