

EV **Electro-Voice**[®]
BK-1632
STEREO MIXERS

OWNER'S MANUAL

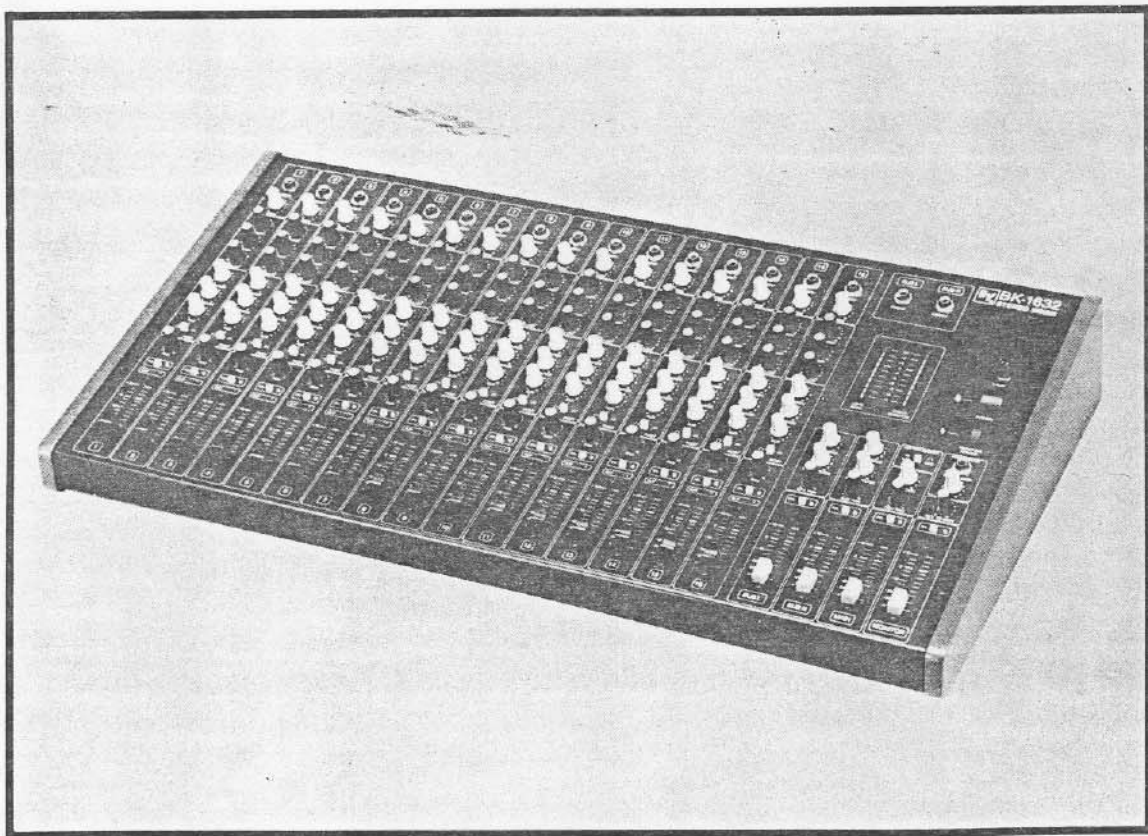

BK-1632
STEREO MIXER

INTRODUCTION

Congratulations — you have just made one of the "best buys" of your audio career. The Electro-Voice BK-1632 was designed to deliver exceptional performance at an affordable price.

The BK-1632 provides the flexibility and sonic quality required by today's working musician. The five mixing busses and channel patch points enable the use of multiple effects and processors. The prefade listen or solo system is invaluable for fine-tuning the mix. Vocalist will find the reverb to monitor send useful in providing a "wet mix" for stage monitors. With the addition of on-board phantom power, any dynamic or condenser microphone can be used without separate power supplies.

The BK-1632 is a welcome addition to the growing family of Electro-Voice electronic products. The engineers at Electro-Voice have put 30 years of audio know-how and pride into the BK-1632.

TABLE OF CONTENTS**I INTRODUCTION****1. INPUT CHANNEL CONTROLS AND FUNCTIONS**

- 1A Trim
- 1B EQ Controls
- 1C Effects Reverb Send
- 1D Monitor Send
- 1E Auxiliary Send
- 1F PAN Pot
- 1G PFL
- 1H Channel Fader
- 1I Channel Clip LED
- 1J Channel Patching Insert Jack

2. OUTPUT SECTION CONTROLS AND FUNCTIONS

- 2A Effects Master Send
- 2B Effects Return Level
- 2C Effects PAN
- 2D Auxiliary Master Send
- 2E Auxiliary Return Level
- 2F Auxiliary PAN
- 2G Reverb Section
 - 2G-1 Reverb Level
 - 2G-2 Reverb PAN
 - 2G-3 Reverb to Monitor
- 2H Master Section Controls
 - 2H-1 Left Submaster
 - 2H-2 Right Submaster
 - 2H-3 Main Master
 - 2H-4 Monitor Master
- 2J Meter Assignment Switch
- 2K LED VU Indicators
- 2L Subgroup Insert Jack
- 2M Lamp Connector
- 2N Power Indicator
- 2O Phantom Power Switch
- 2P Phantom Power Indicator
- 2Q Phone Gain
- 2R Headphone Jack

3. REAR PANEL INPUT CONNECTORS

- 3A Balanced Low-Z Mic Input
- 3B High-Z Line Input
- 3C Effects Return
- 3D AUX Return
- 3E Effects IN
- 3F Monitor IN
- 3G Aux IN

4. REAR PANEL OUTPUT CONNECTORS

- 4A Sub R — Right Subgroup Output
- 4B Sub L — Left Subgroup Output
- 4C Main Output
- 4D Monitor Output
- 4E Effects Send
- 4F AUX Send

5. TROUBLESHOOTING WARRANTY**6. SCHEMATIC DIAGRAMS SPECIFICATIONS SIGNAL FLOW DIAGRAM**

GENERAL SPECIFICATIONS

FREQUENCY RESPONSE —

Mic Input to Any Output, EQ Flat, All Faders Nominal
20-20,000 Hz ± 1 dB

TOTAL HARMONIC DISTORTION —

<0.05% at +4 dBu¹, 20-20,000 Hz
<0.10% at +20 dBu, 20-20,000 Hz

NOISE —

(20-20,000 Hz with 150-ohm input impedance)
-128 dBu EIN-equivalent input noise, mic input
(theoretical minimum noise is -130 dBu across 150 ohms)
-90 dBu residual at main out (all faders down)
-90 dBu residual at monitor out

INPUT CHANNEL EQUALIZATION —

±15 dB shelving at 100 Hz
±12 dB peak/dip at 3 kHz
±15 dB shelving at 10 kHz

MICROPHONE INPUTS —

Low impedance, balanced — pin 2 reference positive
Maximum input level: +6 dBu (1.5 V)
Input impedance at 1 kHz: 4.4 kΩ
Common Mode Rejection Ratio,
Typical: -65 dB
Minimum, 60-10,000 Hz: -50 dB

LINE INPUTS —

High impedance, balanced tip positive
Maximum input level: +24 dBu (12 V)
Input impedance: 70 kΩ

PEAK INDICATOR THRESHOLD

+15 dBu

MAXIMUM VOLTAGE GAIN ±3 dB —

85 dB — Mic In to Main Out	60 dB — Line In to Main Out
75 dB — Mic In to Monitor Out	50 dB — Line In to Monitor Out
75 dB — Mic In to Sub Out	50 dB — Line In to Sub Out
52 dB — Mic In to Insert Jack	27 dB — Line In to Insert Jack
82 dB — Mic In to EFX Send	57 dB — Line In to EFX Send
	50 dB — Line in to AUX OUT

CROSSTALK —

-75 dB typical — Adjacent inputs, 1 kHz
-75 dB typical — Input to output, 1 kHz
-50 dB minimum — All combinations, 20-20,000 Hz

LAMP CONNECTOR —

BNC connector, 12.6 V ac/0.20 amps maximum

PHANTOM POWER —

48 V dc at pins 2 and 3 on mic connector, 3.4 kΩ source resistance

LEVEL DISPLAY —

10-Segment LED in 3 dB Steps:
Range: -18 dB to +9 dB
Reference "0": +4 dBu
Response: Full wave, average responding

HEADPHONE OUTPUT —

Output: 20 mW into 8 Ω
Frequency Response: 50-15 kHz ±2 dB

PFL (pre fader listen): Switchable for input and output channels

AUX SEND Input Channels: Switchable pre- or post-fader and EQ

DIMENSIONS —

Height: 130 mm (5.125 in.)
Depth: 460 mm (18.125 in.)
Width: 832 mm (32.75 in.)

NET WEIGHT —

16.8 kg (37.0 lb)

POWER REQUIREMENT —

25 Watts Maximum
Available for 95-130 volts, 60 Hz

LINE LEVEL INPUTS

OUTPUTS

	MAXIMUM LEVEL	INPUT IMPEDANCE		MAXIMUM ¹ LEVEL	MINIMUM LOAD	INTERNAL IMPEDANCE
Left Insert	+20 dBu	100 kΩ	Main	+20 dBu	600 Ω	50 Ω
Right Insert	+20 dBu	100 kΩ	Monitor	+20 dBu	600 Ω	50 Ω
EFX Return	—	≥ 15 kΩ	Left Sub	+20 dBu	600 Ω	50 Ω
EFX Input	+40 dBu	16 kΩ	Right Sub	+20 dBu	600 Ω	50 Ω
Monitor Input	+29 dBu	10 kΩ	Left Insert	+20 dBu	600 Ω	50 Ω
Aux Return	—	≥ 15 kΩ	Right Insert	+20 dBu	600 Ω	50 Ω
Input-Channel Insert ¹	+20 dBu +5 dBu	1.8 k Flat EQ, 1 k Max. Boost EQ	EFX Send	+20 dBu	600 Ω	50 Ω
Aux Input	+29 dBu	10 kΩ	Input-Channel Insert	+20 dBu	2000 Ω	100 Ω
			Aux Out	+20 dBu	600 Ω	50 Ω

1. Requires a source impedance of 100 Ω or less.

1. 0 dBu is 0.775 volts, RMS.

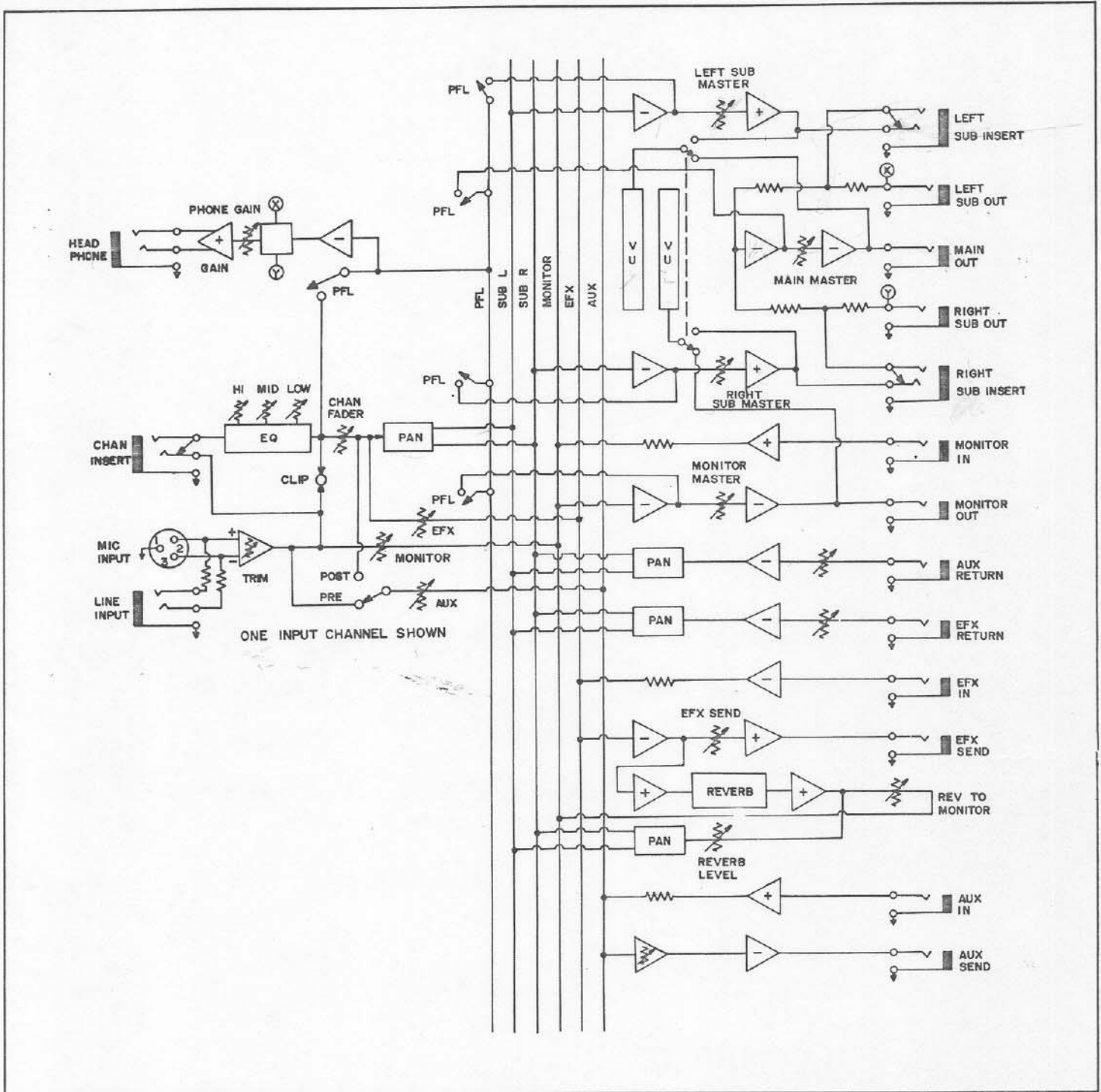

SIGNAL FLOW DIAGRAM

SECTION 1.0

1.0 INPUT CHANNEL CONTROLS (Figure 1)

The input channel is the beginning of the signal processing phase of the mixer. Each input channel will accept one signal source which may be then equalized, have reverb or other effects added, sent to a monitor system, and last but not least, sent to the main system for the audience to hear. Each input has a low impedance microphone input (the 3-pin XLR or Cannon connector) and a high impedance mic or line input (1/4 in. phone jack). The line input will accept signals from an instrument, high-impedance microphone, tape machine, electronic drummer or almost any other audio source. Always make sure that the channel fader (sec. 1H) or master faders (sec. 2H) are down before plugging or unplugging input sources.

1A. TRIM

The TRIM control adjusts the gain or amplification of the input amplifier. This is necessary to accommodate the wide variation in signal strength presented to the mixer by the almost endless variety of signal sources — vocal mics, instrument mics, tape machines, etc. The TRIM control allows you to optimize the amplification for each individual input source. This results in the best signal-to-noise ratio (... no hiss) and at the same time, best freedom from overload distortion.

The TRIM control is used to match the gain of the first preamp stage to the signal strength of the source being run through the channel. To get the cleanest, quietest operation from the board it is important that the TRIM control be properly set.

To set up a mix, first set all TRIM controls at "0" (minimum). Set all the input and subgroup slide faders at "0". Then adjust the TRIM controls for a rough mix (see sec. 1I), and do the fine tuning with EQ and faders as necessary. Whenever possible, it is best to try to maintain that "straight line" relationship between all faders. When this is done, all the levels within the console are very close to being optimized for the best noise and distortion performance. Once the correct TRIM setting is established, make all volume adjustments with the appropriate channel fader (sec. 1H).

In general, the lowest noise operation (greatest dynamic range) will be obtained when the TRIM control is set at a point just below where the CLIP light would flash.

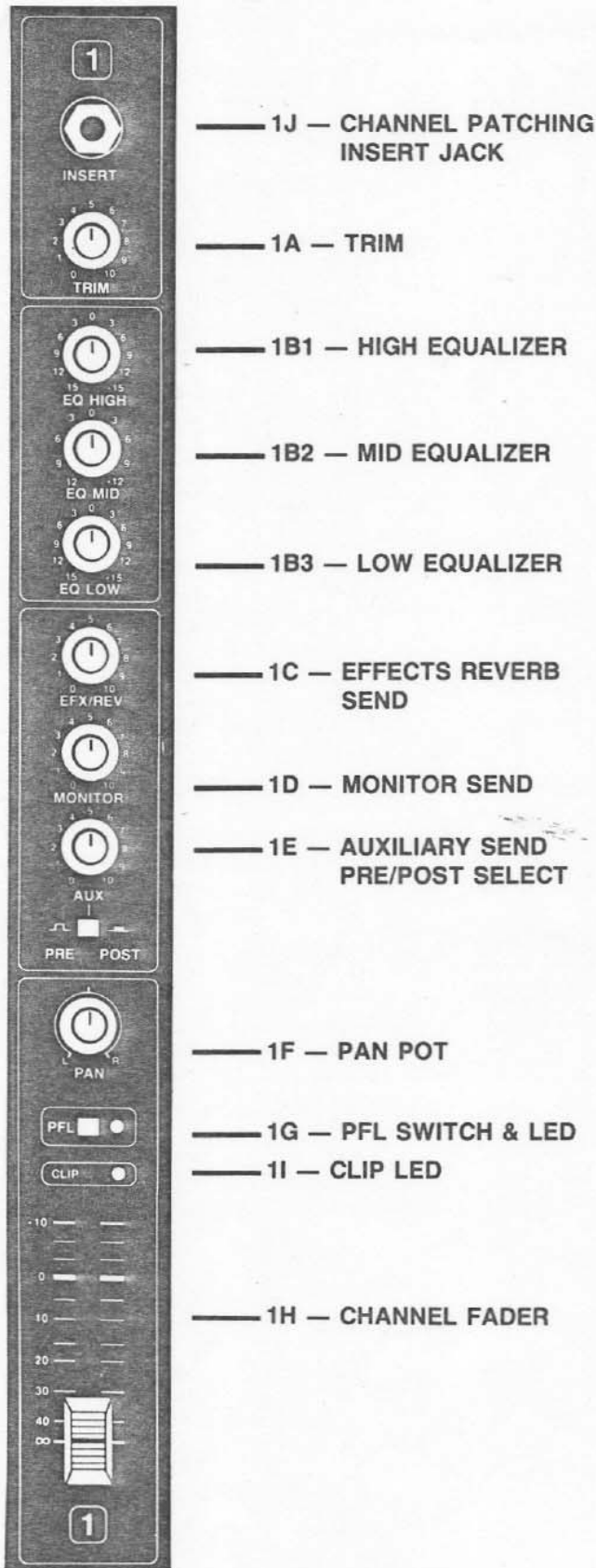

—— 1J — CHANNEL PATCHING INSERT JACK

—— 1A — TRIM

—— 1B1 — HIGH EQUALIZER

—— 1B2 — MID EQUALIZER

—— 1B3 — LOW EQUALIZER

—— 1C — EFFECTS REVERB SEND

—— 1D — MONITOR SEND

—— 1E — AUXILIARY SEND PRE/POST SELECT

—— 1F — PAN POT

—— 1G — PFL SWITCH & LED

—— 1I — CLIP LED

—— 1H — CHANNEL FADER

FIGURE 1 — Input Channel Functions

set to their designated normal operating points, the circuits in the board are optimized for minimum noise and distortion. In other words, the signal levels are high enough to keep noise from creeping in and low enough to ensure plenty of headroom and freedom from clipping distortion. If the fader must run wide open to get enough level, turn up the TRIM control or increase the setting of the left and right submaster controls. Conversely, if the fader must be pulled way back to get the right level, the TRIM control or stereo submasters should be adjusted. Adjust the TRIM control if the CLIP LED lights, otherwise adjust the stereo submasters. For optimum performance, the channel FADERS (sec. 1H) should be run close to the "0" mark.

1I. CLIP LED

The channel CLIP LED monitors the input channel circuit for clipping or overload (both before and after the EQ section). If it lights, you are bordering on distortion. You'll hear this in the output as a harsh, blaring sound on volume peaks. This might be caused by excessive boost in the channel equalization controls (sec. 1B), or a TRIM control setting that is too high for the input signal (sec. 1A). Generally, readjusting the TRIM control (sec. 1A) will suffice.

1J. CHANNEL PATCHING INSERT JACK (one supplied with the unit)

This space saving (two-connectors-in-one) jack allows you to add external signal processing gear to a particular channel, without disturbing any of the other channels. A 3-conductor (stereo) phone plug is used for both the output from the channel preamp, and for the return to the mixer's output stages from the external processing device. The diagram indicates how a channel patching cord should be wired. This cable can also be purchased from any of several audio cable manufacturers.

HOW TO WIRE A CHANNEL PATCHING CORD

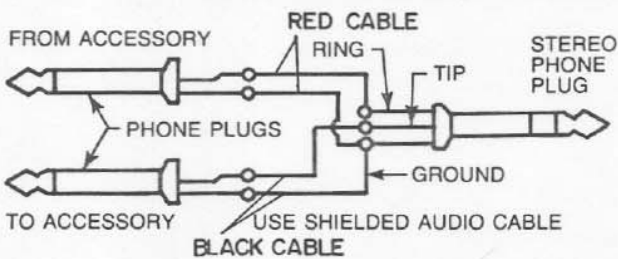

The channel patching jack can be used with equalizers, limiters, compressors, external reverb or dealy systems and the like. Just be sure the device you want to patch in has line level unbalanced inputs and outputs. The signal at the insert jack can drive loads of 2,000 ohms or greater, and the external processing device should have a low output internal impedance (100 ohms or less).

A nominal input signal is a level of +4 dBu; the maximum level is +20 dBu.

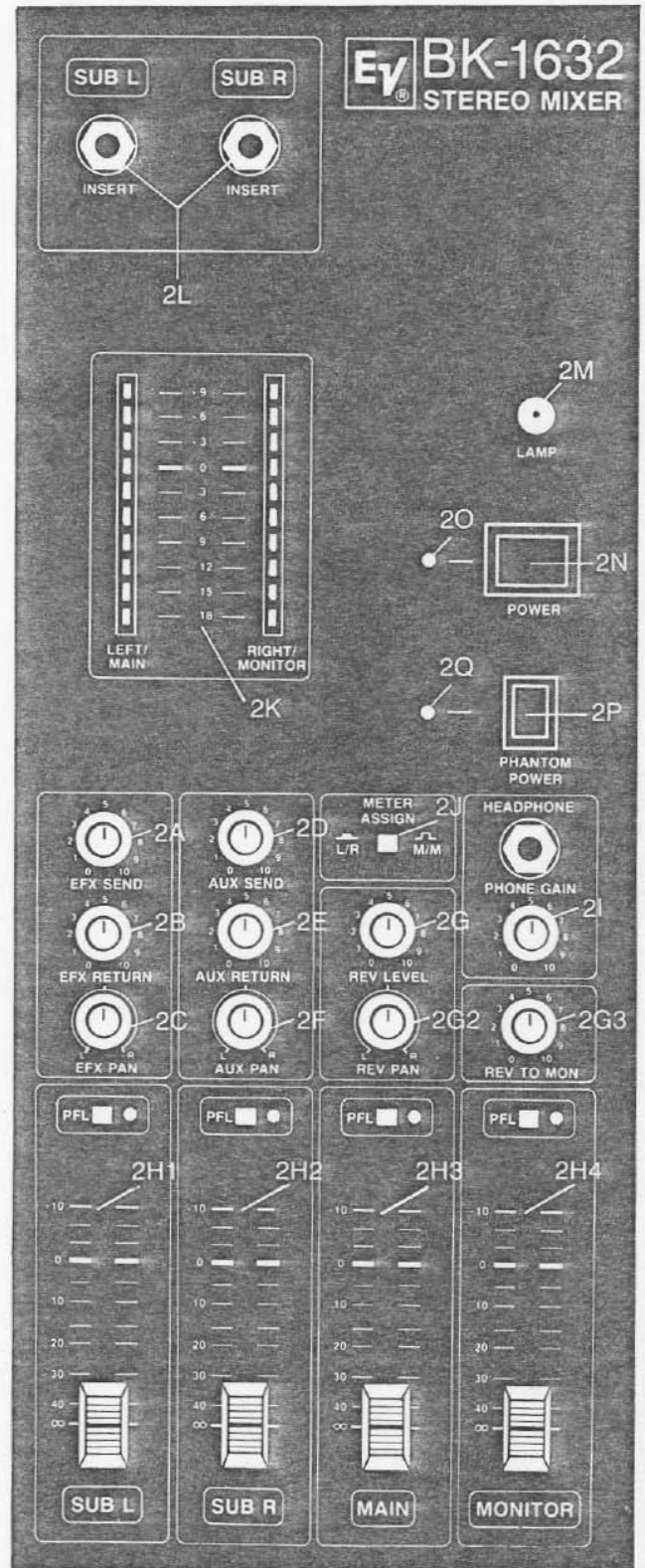

FIGURE 2 — Output Section Controls and Functions

SECTION 2.0**2.0 OUTPUT SECTION CONTROLS (Figure 2)****2.A EFX SEND**

The EFX (effects) SEND control sets the level of the signal appearing at the effects send output jack (sec. 4E) going to any type of outboard effects device(s) such as delay, phase, flanger, etc. It does not affect the signal being sent to the internal reverb system. The source for this signal is via the individual effects/reverb send level controls (sec. 1C) on input channels 1 through 16.

2B. EFX RETURN

The EFX RETURN level control determines the amount of externally generated effects signals in the main mix. This signal is mixed into the left and right stereo sub channels via the EFX PAN control (sec. 2C).

2C. EFX PAN

The EFX PAN control directs the signal coming from the effects return level control into the left and/or right sub channels. The control works in an identical way to the input channel PAN control.

2D. AUX SEND

The AUX (auxiliary) SEND control sets the level of the signal appearing at the AUX SEND output jack (sec. 4F) to any outboard device. The PRE-POST select switch on the channel input will allow you to determine if you want the outboard device to be affected by the channel equalization and fader. In the "PRE" position, the AUX SEND signal is not affected by the channel EQ and fader. In the "POST" position, the AUX SEND signal is affected by the channel EQ and fader.

2E. AUX RETURN

The AUX (auxiliary) RETURN control sets the level of the input signal that is directed to the left and right sub channels through the AUX PAN control (sec. 2F). The AUX RETURN is one of the input locations that can be used to "stack" mixers without using up an input channel.

2F. AUX PAN

The AUX (auxiliary) PAN control directs the signal coming from the AUX input into the left and or right sub channels. The control works in an identical manner to the input channel PAN control.

2G. REVERB SECTION

Reverberation is the natural decay of sound in a closed space (a room). The internal reverb system uses springs to realistically simulate this effect.

The reverb section gets its input signal from the EFX/REVERB send controls on the input channels (sec. 1C).

1. REV LEVEL

The REV (reverb) LEVEL control adds reverberation to the left and right sub channels from any input channel signal whose EFX/REV control is turned up.

Turning the control to the right increases the amount of reverb present in the left and right sub outputs.

2. REV PAN

The REV (reverb) PAN control directs signal from the REV LEVEL control to left or right sub bus. The control works in an identical manner to the input PAN control.

3. REV TO MON

The REV (reverb) to MON (monitor) control adjusts the level of the signal from the internal reverb to the monitor bus. Turn the control clockwise to increase the reverb level at the monitor bus.

2H. MASTER SECTION CONTROLS

The master section controls affect the subgroup, main, and monitor output levels.

The use of subgroups can be demonstrated by this example: If the input channel PAN controls are set fully clockwise for all the vocal microphones, then we will have assigned the SUB R slider as a "vocal submaster". If we raise or lower the SUB R control we can set the proper vocal level in the mix while preserving the input channel balance set among the vocalists.

1. LEFT SUBMASTER

Controls the volume of the left stereo output channel. It is also used as a subgroup master.

2. RIGHT SUBMASTER

Controls the volume of the right stereo channel. It is also used as a subgroup master.

3. MAIN MASTER

The MAIN (monaural) output is an equal mix of the left and right stereo outputs. the MAIN MASTER controls the volume of the output.

4. MONITOR MASTER

Controls the volume of the monitor output signal. The monitor output is a mix of the individual channel monitor sends.

2I. PHONE GAIN

The PHONE GAIN control sets the level at the HEADPHONE jack. Any signal selected by depressing a PFL switch will be monitored through the headphone jack. With no PFL switch depressed, the headphone circuit monitors the left and right sub outputs in stereo.

2J. METER ASSIGNMENT SWITCH

A push-push switch is provided to allow the user to select the points in the circuit which are monitored by the LED VU indicators. When the switch is depressed, the indication will be the audio level at the left sub and right sub outputs. In the other (non-depressed) position, signal level at the main and monitor outputs will be shown.

2K. LED VU INDICATORS

A vertical row of ten light-emitting diodes is used to indicate signal level at selected points in the circuit (see assignment switch). This type of display is free from overshoot (ballistic) problems of mechanical meters, and is highly visible under poor lighting conditions. Each indicator is calibrated in volume units, such that 0 dB corresponds to an output of 1.23 volts, which is +4 dBu, a standard in the industry. The mixer provides 16 dB of headroom above this level for superior sound reproduction. It may be necessary in some cases to reduce the sensitivity of equipment fed by the mixer, such as a power amplifier, to prevent over-driving it. A gain control on the amplifier is usually provided for this purpose.

2L. SUBGROUP INSERT JACK

This jack provides a convenient point to add signal processing devices to the complete left/right submaster mix. The jack is wired the same as the channel insert jacks. The output can drive 600 ohms or greater unbalanced loads up to +20 dBu and the inputs can accept +20 dBu before clipping.

2M. LAMP CONNECTOR

A BNC type socket is provided on the right hand side of the mixer panel to accommodate a *Littlite** gooseneck lamp, and allow operation of the board under dark conditions. The 18-inch long "G," series is available from many professional sound dealers, and attaches without tools. The voltage at the socket is 12.6 V ac at a maximum of 0.2 amps.

2N. POWER SWITCH

The power switch is used to turn on and off the ac main power.

2O. POWER INDICATOR

This LED is illuminated when the ac main power is on.

2P. PHANTOM POWER SWITCH

This switch turns on and off the phantom power supply. The phantom power supply provides power

for condenser-type microphones through the microphone cable. When switched on, it produces 48 volts dc (with 3.4 K-ohm source impedance) at pins 2 and 3 on all of the microphone input connectors. Pin 1 (the shield conductor) provides the ground return path. This will power standard condenser microphones and will not affect most dynamic microphones. When switched on or off, the voltage will ramp slowly up or down; it takes a few seconds to reach full level. This prevents unwanted transients from reaching the microphone inputs.

2Q. PHANTOM POWER INDICATOR

This LED indicates when phantom power is present at the microphone inputs.

SECTION 3.0**3.0 REAR PANEL INPUT CONNECTORS (Figure 3)**

The BK-1632 mixer can accept program material covering a dynamic range of over 100 dB. Except for the high gain mic input all of the line inputs can safely accept signals at least up to +20 dBu. (See Specifications for details).

Several of the inputs that directly access the mix buses can be used to stack mixers together without using up an input channel. The stacking group includes the AUX, EFX and MONITOR inputs. The EFX RET input may be used as another stacking input. For stereo subgroup stacking set EFX PAN to L and AUX PAN to R, and use EFX RET and AUX IN for left and right stacking, respectively.

3A. BALANCED LOW-Z MIC INPUT

A 3-pin XLR-type ("Canon") connector is used for balanced low impedance microphone inputs. The Mic Input is actively balanced; active balancing allows elimination of the input transformer (along with its limitations) while maintaining the RF and hum rejection of a good transformer coupled input.

It is important that, during operation or testing of the mixer, all channel faders remain fully down whenever the mic input is not *properly* terminated with a microphone or equivalent 150-ohm source. An open mic invites the introduction of high noise levels which could produce lower quality sound or an incorrect test measurement.

3B. HIGH-Z LINE INPUT

A standard 1/4-inch phone jack is used for balanced or unbalanced line level signals. Examples of line level signals include most electronic keyboards, synthesizers, turntables (with appropriate preamps), tape decks and the line outputs from other mixers. All input channel controls, including the variable GAIN control, affect the LINE input. Maximum input level before preamp clipping is 12 V or +24 dB.

If a sufficient signal level is not possible with the GAIN control in its furthest clockwise position, the input signal must then be treated as a mic level signal, and connected to the microphone input. If necessary, use an appropriate balancing transformer (EV Model 502CP or equivalent) or a direct box with the microphone (XLR) input.

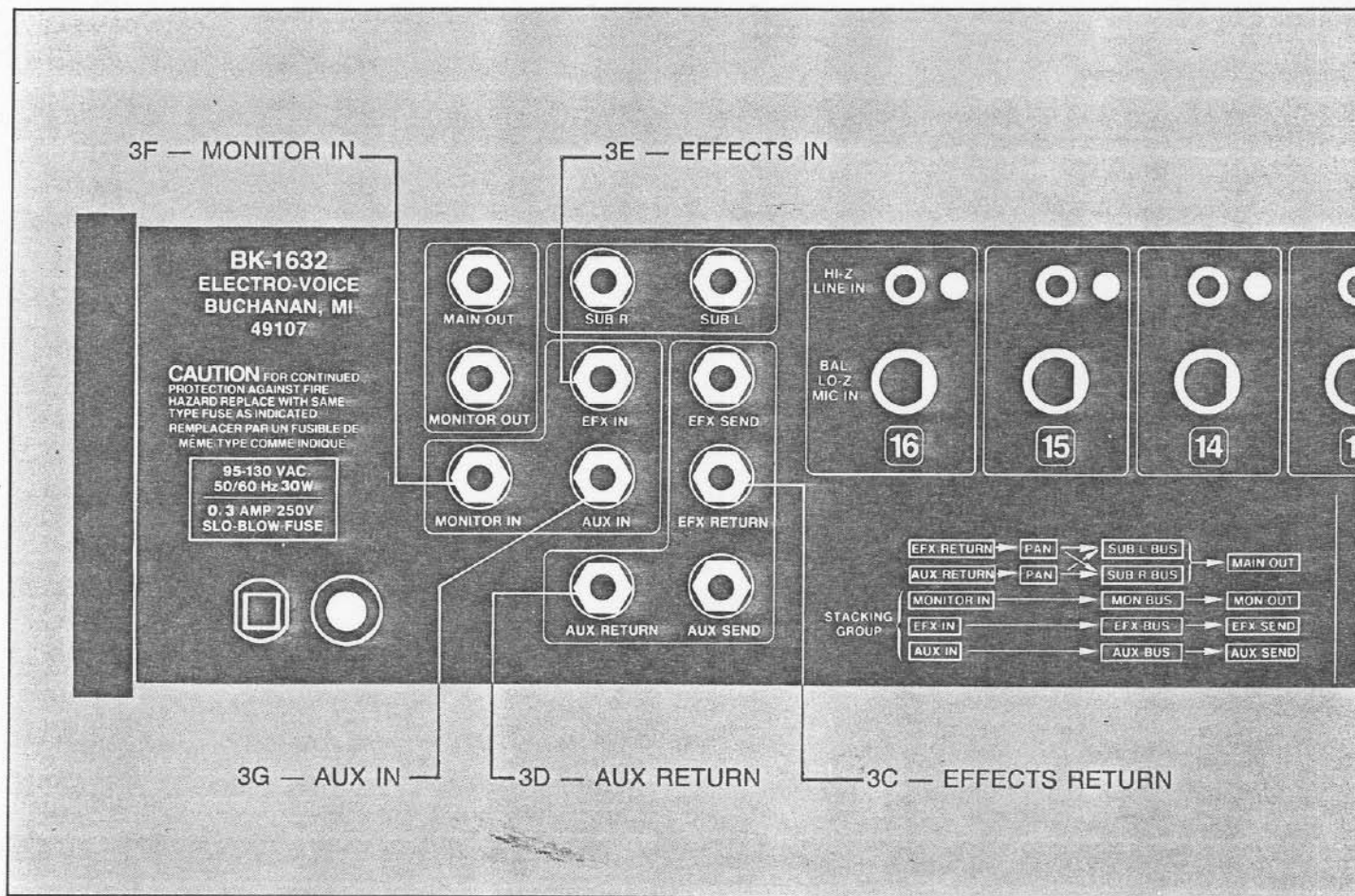

FIGURE 3 — Input Jacks

3C. EFFECTS RETURN

The EFX RET jack accepts line level input signals which can be set with the EFX RET level and the EFX PAN front panel controls. This jack may be used as a stacking input or a second auxiliary input.

3D. AUX RETURN

The AUX RETURN jack is used for signals to be fed to the subgroup buses. The signal is controlled by the AUX RETURN and AUX PAN front panel functions. The AUX RETURN is part of the "stacking group".

3E. EFFECTS IN

The EFX IN jack will put line level signals directly onto the effects bus. Crosstalk and buffering protection are provided by the input circuit, signal level is controlled by the external source. The EFX IN is part of the "stacking group".

3F. MONITOR IN

The MONITOR IN jack will put signals directly onto the MONITOR bus. Crosstalk and buffering protection are provided by the input circuit; signal level is controlled by the external source. The MONITOR IN is part of the "stacking group".

3G. AUX IN

The AUX IN jack will put signals directly onto the AUX bus. Crosstalk and buffering protection are provided by the input circuit; signal level is controlled by the external source. The AUX IN is part of the "stacking group".

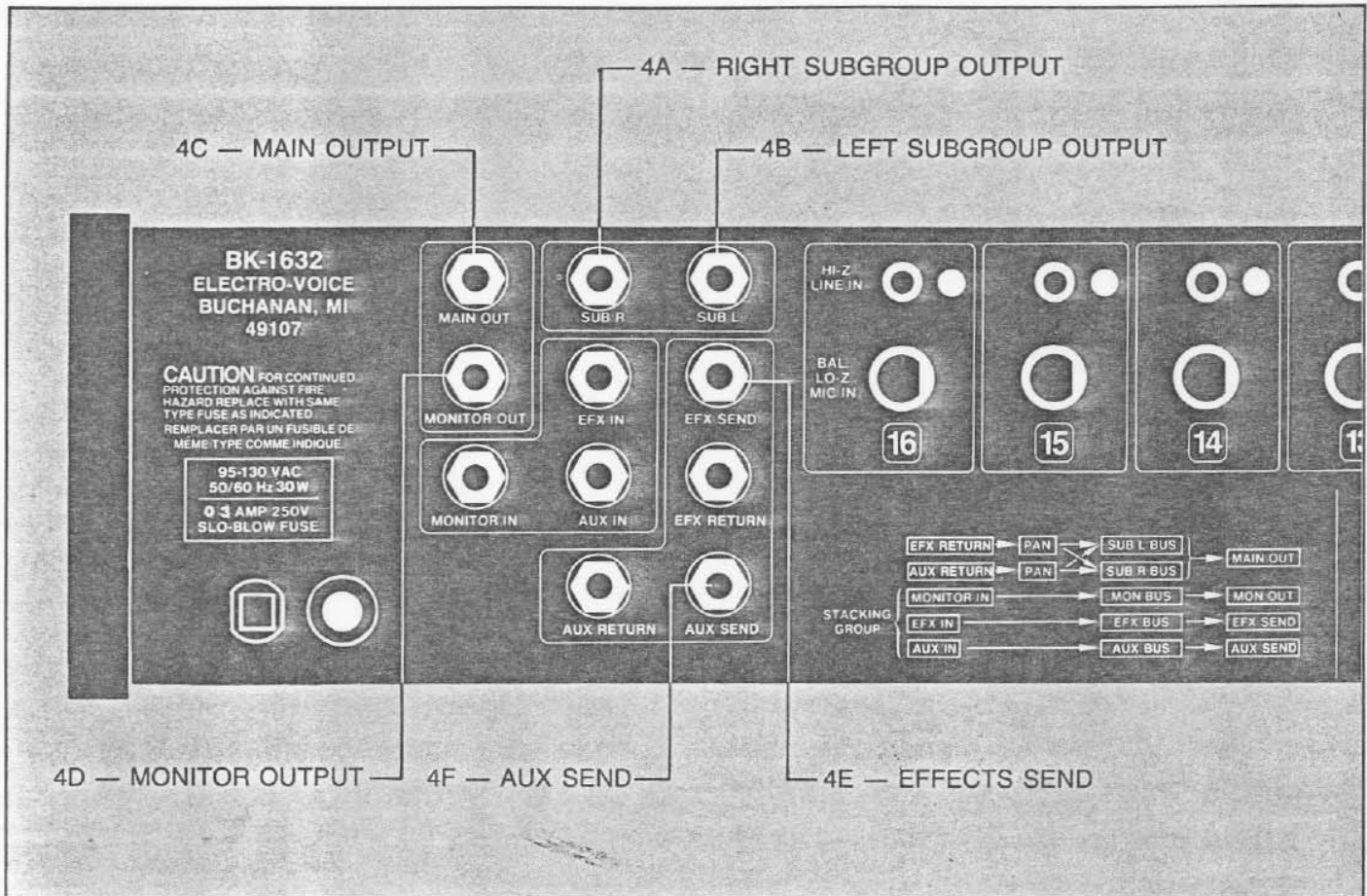

FIGURE 4 — Output Jacks

SECTION 4.0

4.0 REAR PANEL OUTPUT CONNECTORS (Figure 4)

All output connections are line level, unbalanced, and made through standard 1/4-inch phone jacks. Each output is capable of driving 600 ohms or more to a maximum level of +20 dBu. (See Specifications for details).

In the BK-1632 mixer all signal paths maintain polarity; that is, a positive going signal at any input or insert point will produce a positive going signal at the appropriate output.

4A. SUB R RIGHT SUBGROUP OUTPUT

This output is derived by summing all of the inputs (channels and external) assigned to the right subgroup bus. A PAN control rotated fully clockwise to the "R" position will assign that signal only to the right bus.

4B. SUB L LEFT SUBGROUP OUTPUT

This output is the left subgroup equivalent of the Sub R output.

4C. MAIN OUTPUT

The MAIN output is a 50/50 mix of the right and left subgroup outputs. Since the BK-1632 is a true subgroup mixer, all signals that appear in the main mix must come through the subgroup channels.

4D. MONITOR OUTPUT

The MONITOR output signal is the sum of all of the input channel monitor sends and the external monitor input signal.

4E. EFFECTS SEND

The EFFECTS SEND output signal is the sum of all of the input channel EFX/REV sends plus any signal coming through the EFX IN.

4F. AUX SEND

The AUX SEND output signal is the sum of all of the input channel AUX sends (PRE- or POST-EQ and fader) plus any signal coming through the AUX IN input.

SECTION 5.0**5.1 SERVICE AND WARRANTY INFORMATION****5.0 TROUBLESHOOTING****5A. IN CASE OF DIFFICULTY**

1. Don't panic, be systematic, change one thing at a time. Check the obvious!!! Verify input connections.
2. Check all cables. Many system problems are caused by poor cables.
3. If there are no lights, check ac power source, power switch and power fuse.
4. If the problem is one of a "dead" input, verify by trying the same source in another input.
5. Verify problems by substituting the bad part with one that works. Do this by moving the cable from the one that works to one that doesn't.
6. Fuses that blow instantly on turn-on are a sign of internal distress and mean that you should refer the unit to "qualified service personnel".
7. Don't panic, be systematic, change one thing at a time. Check the obvious!!!

WARRANTY (Limited) — All Electro-Voice products are guaranteed against malfunction due to defects in materials and workmanship for a specified period beginning at the date of original purchase. If such a malfunction occurs, the product will be repaired or replaced (at our option) without charge during the period and under the limitations stipulated in the data sheet or owner's manual for that individual product, if delivered prepaid to the proper Electro-Voice service facility. The unit will be returned prepaid. Warranty does not extend to finish, appearance items, or malfunction due to abuse or operation under other than specified conditions, nor does it extend to incidental or consequential damages. Some states do not allow the exclusion or limitation of incidental or consequential damages, so the above exclusion may not apply to you. Repair by other than Electro-Voice or its authorized service agencies will void this guarantee. A list of authorized warranty service centers is available from Electro-Voice, Inc., 600 Cecil Street, Buchanan, MI 49107 (AC/616-695-6831); Electro-Voice, Inc., 3810 148th Avenue, N.E., Redmond, WA 98052 (AC/206-881-9555); and/or Electro-Voice West, 8234 Doe Avenue, Visalia, CA 93291 (AC/209-651-7777). This warranty gives the customer specific legal rights, and there may also be other rights which vary from state to state.



FACTORY SERVICE ADDRESS

Electro-Voice, Inc.
Service Department
3810 148th Avenue, N.E.
Redmond, WA 98052
(206) 881-9555

SECTION 6.0

6.0 SCHEMATIC

SERVICE INFORMATION

1. Resistance values are indicated in ohms unless otherwise specified.
(K=1,000, M=1,000,000)
2. Capacitance values are shown in microfarads unless otherwise noted.
(P=Picofarads)
3. All voltages are referred to ground under the following conditions.
DC: No signal except where indicated.
AC: Rms
4. **PRECAUTION** -
 - a) All components marked  must be replaced only with original type specified by the manufacturer, electro-voice and installed as the original with spacers and positioned away from adjacent components where applicable.
 - b) All soldering must be done in a professional manner using solder with resin core only.
 - c) All covers, shield and insulating spacers must be replaced before returning appliance to customer.
 - d) A damaged power supply cord must be replaced before returning appliance to customer.
 - e) A dielectric test consisting of 1500V AC 60Hz is to be applied between both blades of the power supply cord attachment plug and the exposed conductive surface of the appliance for a period of not less than one second before returning to appliance to customer.
 - f) The  marked resistors are mounting above the P.C.B. on sleeves.

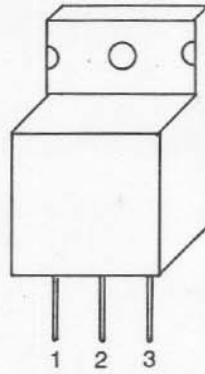

PIN NO.	1	2	3
KTD 880	B	C	E
7815	IN	G	OUT
7915	G	IN	OUT

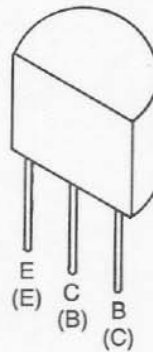

2SD 1111 (OR 2N6427)
KTCI 815
KTA 200
KTC 200
KTA 970

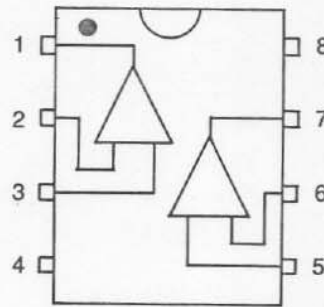

072D
NE 5532
TA 75558P

LM 3915 CONNECTION DIAGRAM

- | | |
|---------------------|---------------|
| 1. LED NO. 1 | 10. LED NO 10 |
| 2. V- | 11. LED NO 9 |
| 3. V+ | 12. LED NO 8 |
| 4. DIVIDER | 13. LED NO 7 |
| 5. SIGNAL INPUT | 14. LED NO 6 |
| 6. DIVIDER | 15. LED NO 5 |
| 7. REFERENCE OUTPUT | 16. LED NO 4 |
| 8. REFERENCE ADJUST | 17. LED NO 3 |
| 9. MODE SELECTOR | 18. LED NO 2 |

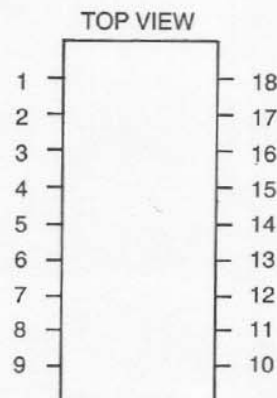

Free Manuals Download Website

<http://myh66.com>

<http://usermanuals.us>

<http://www.somanuals.com>

<http://www.4manuals.cc>

<http://www.manual-lib.com>

<http://www.404manual.com>

<http://www.luxmanual.com>

<http://aubethermostatmanual.com>

Golf course search by state

<http://golfingnear.com>

Email search by domain

<http://emailbydomain.com>

Auto manuals search

<http://auto.somanuals.com>

TV manuals search

<http://tv.somanuals.com>