



**Electro-Voice<sup>®</sup>**

***STEREO POWERED MIXER***

***PSX1000***

***PSX1600***

***PSX2200***

## **OWNER'S MANUAL**

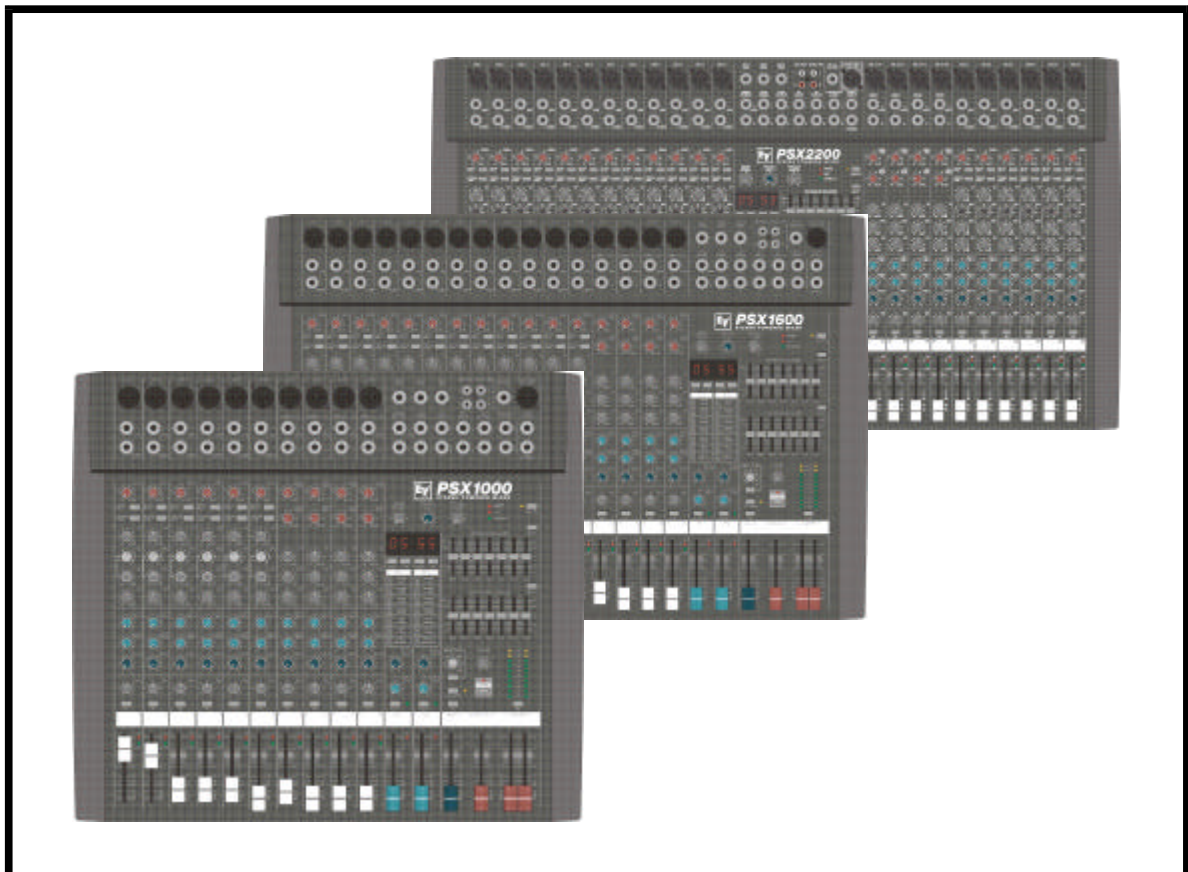

# CONTENTS

Introduction .....	3
Input/Mono .....	4
Input/Stereo .....	8
Effect .....	10
AUX3 .....	12
Phones + Mono Out + Standby .....	13
Master + Power Amplifier .....	14
Rear panel .....	18
Standard installation + Master patchbay and installation alternatives .....	19
Specifications .....	26
Block diagram .....	27
Dimensions .....	28
Warranty .....	32

## IMPORTANT SAFETY INSTRUCTIONS

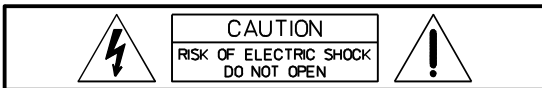

WARNING: TO REDUCE THE RISK OF FIRE OR ELECTRIC SHOCK, DO NOT EXPOSE THIS APPLIANCE TO RAIN OR MOISTURE.

AVIS: RISQUÉ DE CHOC ELECTRIQUE. NE PAS OUVRIR.



The lightning flash with arrowhead symbol, within an equilateral triangle is intended to alert the user to the presence of uninsulated "dangerous voltage" within the product's enclosure that may be of sufficient magnitude to constitute a risk of electric shock to persons.



The exclamation point within an equilateral triangle is intended to alert the user to the presence of important operating and maintenance (servicing) instructions in the literature accompanying the appliance.

1. Read these instructions.
2. Keep these instructions.
3. Heed all warnings.
4. Follow all instructions.
5. Do not use this apparatus near water.
6. Clean only with a dry cloth.
7. Do not block any of the ventilation openings. Install in accordance with the manufactures instructions.
8. Do not install near any heat sources such as radiators, heat registers, stoves, or other apparatus that produce heat.
9. Only use attachments/accessories specified by the manufacturer.
10. Refer all servicing to qualified service personnel. Servicing is required when the apparatus has been damaged in any way, such as power-supply cord or plug is damaged, liquid has been spilled or objects have fallen into the apparatus, the apparatus has been exposed to rain or moisture, does not operate normally, or has been dropped.

### For US and CANADA only:

Do not defeat the safety purpose of the grounding-type plug. A grounding type plug has two blades and a third grounding prong. The wide blade or the third prong are provided for your safety. When the provided plug does not fit into your outlet, consult an electrician for replacement of the obsolete outlet.

## IMPORTANT SERVICE INSTRUCTIONS

**CAUTION: These servicing instructions are for use by qualified personnel only. To reduce the risk of electric shock, do not perform any servicing other than that contained in the Operating Instructions unless you are qualified to do so. Refer all servicing to qualified service personnel.**

1. Security regulations as stated in the EN 60065 (VDE 0860 / IEC 65) and the CSA E65 - 94 have to be obeyed when servicing the appliance.
2. Use of a mains separator transformer is mandatory during maintenance while the appliance is opened, needs to be operated and is connected to the mains
3. Switch off the power before retrofitting any extensions, changing the mains voltage or the output voltage.
4. The minimum distance between parts carrying mains voltage and any accessible metal piece (metal enclosure), respectively between the mains poles has to be **3 mm** and needs to be minded at all times. The minimum distance between parts carrying mains voltage and any switches or breakers that are not connected to the mains (secondary parts) has to be **6 mm** and needs to be minded at all times.
5. Replacing special components that are marked in the circuit diagram using the security symbol (Note) is only permissible when using original parts.
6. Altering the circuitry without prior consent or advice is not legitimate.
7. Any work security regulations that are applicable at the location where the appliance is being serviced have to be strictly obeyed. This applies also to any regulations about the work place itself.
8. All instructions concerning the handling of **MOS** - circuits have to be observed.

**Note:**  **SAFETY COMPONENT (HAS TO BE REPLACED WITH ORIGINAL PART ONLY)**

### **FIRST OF ALL, WE WOULD LIKE TO THANK YOU AND CONGRATULATE YOU TO YOUR PURCHASE OF A ELECTRO-VOICE POWER MIXER.**

The design of the PSX compact power mixers is based on decades of experience, research and development as well client inter-communication in the professional audio market. With the PSX you own a power mixer that offers a wide range of functionality in a very compact frame. All the troubling experiences with cabling and matching mixers, amplifiers, FX units, and equalizers is history. You now own a device with optimally matched components.

The mixer's ergonomic shape and clearly structured controls allow instant access at all times. Also during the transport you will quickly learn to appreciate the PSX's superiority: recessed handles on both sides, compact dimensions and low weight. Additionally, a sturdy dust hood protects the controls against damaging.

Through its multiple functions, its high dynamic capacity, and extremely low-noise design in combination with the 18bit-Dual-Stereo effects unit and the high-performance power amplifier, the PSX is best equipped for universal use. No matter, whether on-stage, in a home recording environment or in a permanent installation, Electro-Voice's PSX is the ideal partner to meet your expectations of a professional audio device - effective and reliable.

Of course, you want to operate your new PSX as quickly as possible. But please, take your time to read about all connections, functions, and controls, first. Every section is explained systematically and in detail within this owner's manual: the input channels, the effects and the master section as well as the built-in power amplifier. Through the careful perception of the manual you will learn a great deal about all functions and find some useful and practical tips for the daily operation of the PSX. Even more important, you will find some adjustment instructions that should be painstakingly carried out; plus the description of a typical sound reinforcement installation, the block diagram, specifications, connection guidelines, etc... So, take your time and keep on reading.

### **UNPACKING AND WARRANTY**

Open the packaging and take out the PSX. Detach the protective foil of the FX unit's display. In addition to this owner's manual you will find the mains supply cord and the warranty card. Please check, if the warranty registration form is filled out correctly. Only when this form is completed, you will be able to apply for warranty claims. We grant 36 months of warranty, starting with the date of purchase. Therefore, we ask you to also keep the original certificate of purchase together with the warranty certificate.

### **INSTALLATION AND CONNECTIONS**

Always install the PSX on an even surface to allow for sufficient airflow during the operation. The device is equipped with electronically controlled fans to protect the power amplifier against thermal overload. The direction of the airflow is front to rear. Fresh, cold air enters the mixer at its front side and warm air leaves the device through the ventilation louvres in the rear panel. Do not cover the frontal or the rear ventilation louvres, since otherwise, the PSX would automatically enter the protect mode to prevent the occurrence of thermal overload. When the protect mode is engaged, the device is not going to be damaged. But during this period of time regular operation is not possible.

Before establishing the mains connection, please make sure that the device matches the voltage and frequency of your local mains supply. Check the label next to the mains switch. When switching the power on, the internal ventilators will run for about 2 seconds at full speed to give you an acoustical signal that the PSX entered the operation mode. In addition dust particles that might have gotten into the enclosure are blown out.

The SPEAKER OUTPUTS on the rear panel of the PSX are provided through professional standard Speakon connectors which offer an absolutely secure connection. The pin assignment of these sockets is 1+ (hot) and 1- (cold).

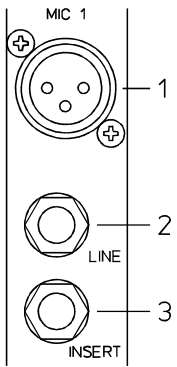

## 1. MIC

Electronically balanced XLR-type inputs for the connection of low impedance microphones, like the ones that are featured in big studio -and live mixing consoles. This type of input stage provides extraordinary low- noise signal amplification with extremely low distortion (typical <math><0.002\%</math>) even in the high frequency range.

Generally, any type of microphone can be connected as long as its pin assignment is in accordance with the diagram shown aside. When condenser microphones are connected, you have to press the PHANTOM button which is located in the master section. The microphone gets its operational voltage (+24Vdc) through the mixer so you can forget about battery replacement .

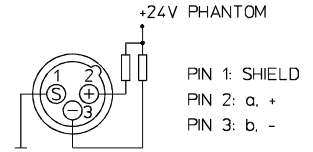

**CAUTION:** Make sure to always connect the microphones before turning on the phantom power or switching the PSX on with phantom power activated. This is the only way to prevent your microphones from damage. Also be sure to engage the stand-by button in the master section to prevent nasty power-on transients.

The connection of condenser type microphones and dynamic microphone models at the same time is possible and should generally not lead to any problems. Before you do so, please refer to the microphone's manual to make sure that this kind of operation is in accordance to the manufacturer's guidelines.

The MIC input is designed for levels between  $-60\text{dBu}$  ...  $+11\text{dBu}$  – depending on the setting of the corresponding gain control. Because of their low impedance design and the phantom power these XLR-type inputs are not meant for cascading other mixing consoles or the connection of FX units, keyboards or other electronic equipment. When connecting this type of equipment, please use the LINE level inputs.

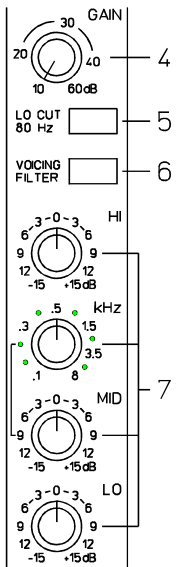

## 2. LINE

Electronically balanced inputs for the connection of electronic instruments, such as keyboards, drum machines, electric guitars and basses with active outputs, as well as all other high-level signal sources, like additional mixers, FX units, CD players, etc.

The LINE input is designed for levels between  $-40\text{dBu}$  and  $+30\text{dBu}$ . The connection of balanced or unbalanced signal sources is handled with monaural or stereo phone plugs, wired according to the diagram below. If the device that you want to connect has a balanced output stage, the use of balanced cables with stereo phone plugs is preferable. This type of connection greatly lowers the induction of external noise or HF interference.



Do not connect signal sources to the MIC and the LINE inputs at the same time, since the signals would interfere with each other, resulting in level reduction.

**One more note:** Please, do not connect electric guitars or basses with passive, high impedance outputs directly to one of the LINE inputs. The LINE inputs of the PSX – like the line level inputs of mixers from all other manufacturers – are meant for the connection of relatively low source impedance of electronic instruments or audio equipment. The reproduction of the instrument's original sound characteristics will be unsatisfactory – unless this effect is intended. Those instruments should be connected using a special transformer, direct box or pre-amplifier with very high input impedance. Musical instruments that are equipped with an active electronic output stage (battery powered) can be connected without problems.

**When connecting signal sources, please make sure that the corresponding channel faders or the master faders are at their minimal settings or that the STANDBY button is engaged. This will save you, your audience, and speakers from unpleasant pop noise.**

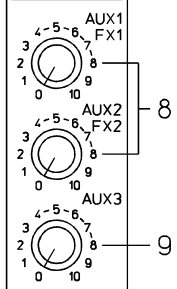

## 3. INSERT

Stereo phone jack with breaker function. The low impedance output is assigned to the tip (send) and the high impedance input (return) is assigned to the ring (body). This jack allows the connection of external compressors, limiters, EQs, etc. into the corresponding channel's signal path. The insertion point is post gain controls, low-cut filters, and voicing-filter stage and pre-EQ section and faders. You have to use a stereo phone plug wired according to the following diagram – in case you intend to use this jack as a true insert bus.

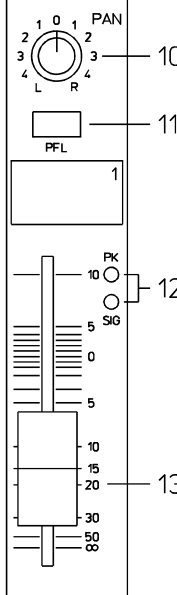
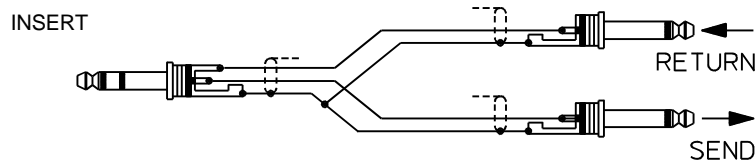

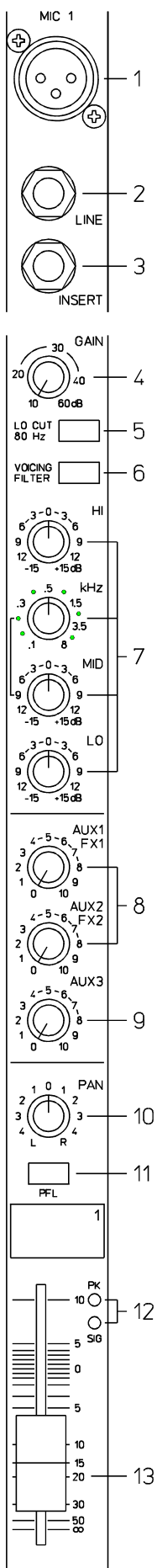

If you want to use this socket as a DIRECT OUT (Pre EQ), the stereo phone plug's tip and ring have to be short circuited, so that the audio signal is not interrupted. If you are using a monaural phone plug instead, you will get a DIRECT OUT with breaker function – the signal flow within the channel is interrupted.

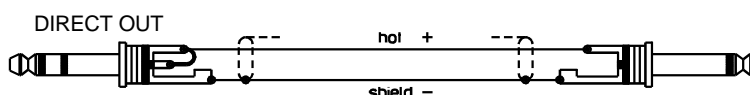

**4. GAIN**

Rotary control to adjust the MIC/LINE inputs' sensitivity. These controls let you optimally adjust the incoming signals to the mixer's internal operation level. Correct adjustment offers the benefits of improved S/N-ratio and provides you with the full bandwidth of the PSX's outstanding sonic capabilities. On the XLR-type connectors, amplification of +10dB is achieved when the control is set all the way to the left and +60dB when the control is turned all the way to the right. When dealing with very low input levels, like those that occur during vocal recordings or when the sound source is located at a distance, the high gain is extremely beneficial. Using the LINE-input, the signal is generally attenuated by -20 dB. The total adjustment range of 50dB stays the same. The LINE-input's unity gain – is achieved at the 20dB mark.

The following is meant as a short note for your assistance on how to determine the correct input level:

**Note on how to adjust the input level:**

1. Set the gain control and the corresponding channel fader to their lowest setting.
2. Connect the desired sound source (microphone, musical instrument, etc.) to the MIC or LINE input.
3. Play the source at its highest volume –sing or speak as loud as possible directly into the microphone or play the instrument.
4. While you are playing the sound source or singing into the microphone, adjust the input level using the gain control, so that during the loudest passages the PEAK LED doesn't blink, but the SIGNAL - LED lights constantly.

This is the basic channel setting, gives you at least 6dB of headroom, which means you have at least 6dB before signal clipping. In case you intend to make further adjustments to the channel's EQ setting, you should perform the steps 3. and 4. again, since changes in the sound shaping section also influence the channel's overall level.

**5. LO CUT 80 Hz**

When the LO CUT switch is engaged, frequencies below 80 Hz are attenuated (18 dB-per-octave). In most cases using the LO CUT filter with microphone channels is a good advice, since it efficiently suppresses popping sounds and rumbling noise. The only exceptions are kick drum and acoustic bass.

Sometimes it can be also very effective to combine the LO CUT filter with the **VOICING** filter. For instance to provide a "thin" voice with more "body", without getting additional low-pitched noise. Whenever the LO CUT is engaged, raising the bass level (LO EQ) provides you with a richer sound, but without additional rumbling or popping noise.

Another welcome side effect is, that the power amplifier and the connected loudspeakers do not get "polluted" with unnecessary low-pitched noise. And the audience will be thankful for the use of the LO CUT filter, too, since they can enjoy a truly clear, natural, and powerful sound performance.

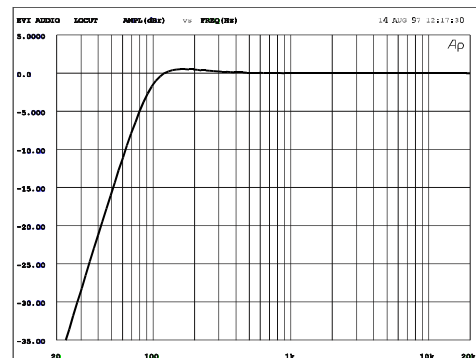

**6. VOICING FILTER**

This button activates an asymmetric microphone filter, which can be used in addition to the channel EQ. The **VOICING** filter enhances the first harmonics of the human voice and slightly attenuates the mid frequency range. This voice shaping method provides precisely audible, intelligible, and powerful vocals that are clearly emphasized from the rest of the mix and is not achievable using ordinary third or octave equalizers.

The use of this filter is not restricted to vocals only. Horns, woodwinds, and other acoustic instruments can also profit from the voicing filter.

We leave it entirely up to your creativity to try the filter with as many different sound sources as you like. Normally, you do not have to worry about the occurrence of feedback.

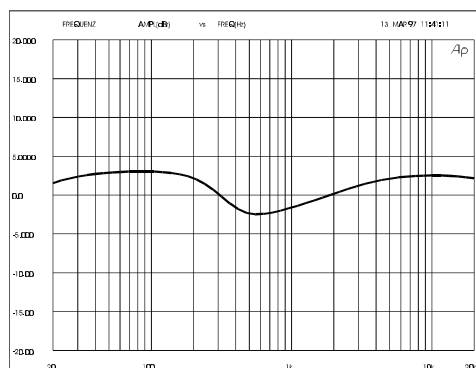

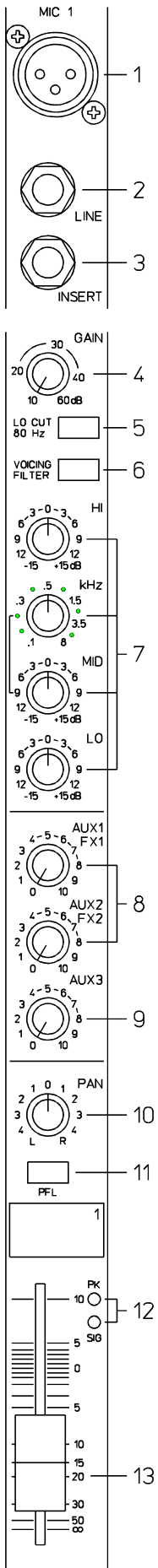

**7. EQ SECTION**

The mixer's EQ section allows shaping of the audio signal within different frequency bands. Turning one of the EQ level controls to the right enhances/amplifies the corresponding frequency range while turning them to the left lowers/attenuates the signal of the specific frequency band. Before you begin to alter the sound, all EQ controls should be set to their neutral position; that is: their detented, center position. Try to avoid setting the EQ controls to extreme positions. Usually, minor changes are totally sufficient and produce the best results in the overall mix. You should use natural reproduction as an benchmark and rely on your musically trained ear, being the best instrument to judge the sound quality. The moderate use of the **MID** control is the best remedy for avoiding acoustical feedback. In this frequency range, you should try to avoid excessive enhancement. Lowering the level in this band will provide you with high amplification with lower likelihood of feedback.

Use the **LO** control according to your pleasing, to add more "punch" to the sound of a kick drum or "body" to the vocals. Use the **HI** control in the same way to provide cymbals and the human voice with more treble and a more transparent sound. The MID EQ section offers separate rotary controls for the adjustment of the level (**MID**) and the frequency band (**kHz**) between 800 Hz and 8 kHz.

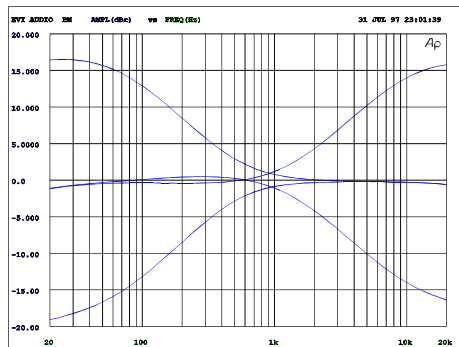

LO-HI EQ

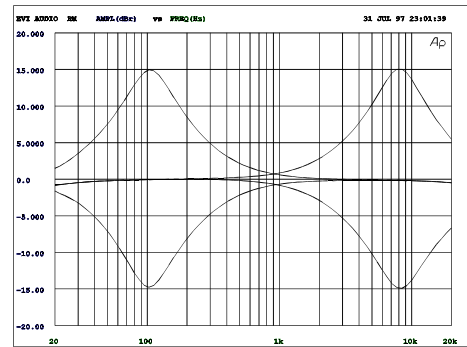

MID EQ

Adjustments in the MID range are certainly the most effective way to shape the sound. As a matter of fact, determining the correct center frequency is not always as easy as it seems. Here is one method – amongst others – how to quickly find the right setting of the parametric EQ for your application.

**Note on how to adjust the parametric EQ:**

1. Slightly lower the channel fader to avoid feedback.
2. Turn the MID rotary control all the way to the right (+15dB).
3. Play the desired sound source or talk into the microphone.
4. Meanwhile turn the frequency rotary control (kHz) slowly from left to right.
5. Quickly, you will detect the frequency range that is not to your liking or causing feedback.
6. Leave the frequency control in this position and turn the MID control to the left until the sound is natural or to your liking.

Enhancing a specific frequency range is a different story. In this case perform steps 1 to 4 as described above. Set the frequency rotary control to the range you want to enhance or leave it at the position where the sound is most satisfactory. Now you can use the MID control to determine the amount of alteration.

**8. AUX/FX**

The AUX/FX controls are used to adjust individual amounts of channel signals to be routed to the FX1 or the FX2 units. The split point of the "dry" signal is POST FADE or in other words: the signal path is split after the audio signal has passed all stages of the channel module, including the volume fader. That is the reason why the fader setting also influences the amount of the signal that is fed to the FX units. By using the AUX/FX controls, it is easy to establish an effects mix. For example, you can assign the short reverb effect of the FX1 unit to the lead vocals and a combined effect program – echo, hall, and chorus – via FX2 to the background vocals. To determine the desired intensity of each effect, you should start with the controls set at their center and make individual adjustments from there on. Also keep in mind that there are two AUX/FX1/2 send controls located within the master section which control the total amount of the FX signals. When you begin to establish the effect mix these controls should also be set at their center position.

In case you are not using the internal FX units and/or you want to connect external signal processing units, the pre-mixed AUX/FX1/2 signals are outputted via the AUX1/2 send jacks. Please monitor the PEAK LEDs in the FX1/2 channels. The indicator should only light briefly at the occurrence of high program peaks. If the indicator is constantly lit, you should lower the send levels of those channels where the program peaks occur. For further information, please read the paragraphs about the FX1/2 units.

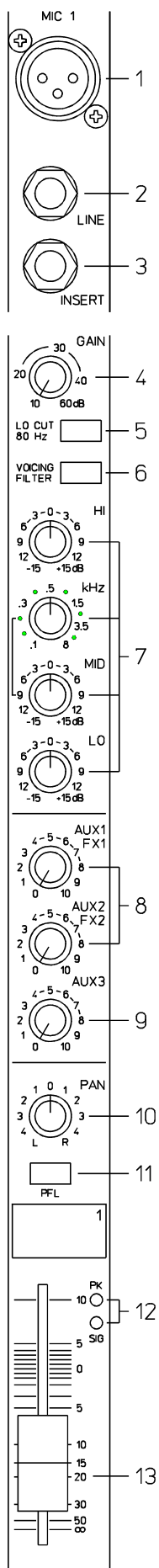

**9. AUX 3**

The AUX 3 control is primarily meant for the monitor mix. Nevertheless, when the master section's AUX3 POST button is pressed, it can also be used as a third FX send bus. In that case, the signal is split post-fader and outputted via the AUX 3 send jack.

To establish a monitor mix you can choose between two alternatives. The main difference being the point where the signal is split according to the setting of the AUX3 POST button.

If the AUX3 POST button is not engaged, the signal split is PRE FADER – the setting of the channel faders does not affect the signal level that is present at the AUX3 rotary controls. Since the monitor mix is not influenced by the setting of the channel faders, this alternative is primarily used when the main mix and the monitor mix have to be completely different – the volume of specific musical instruments or vocals needs to be higher or lower or should not appear at all in the monitor mix. This mode is also preferable when the PSX is operated by an engineer in the audience area (front of house).

The other alternative should be used when you have to operate the mixer on-stage and still want to have control over the main mix.

If the AUX3 POST button is engaged (LED is lit), the signal at the AUX3 rotary control is POST FADER – the signal is split after it passes the channel faders and therefore is affected by their settings. Setting all AUX3 controls to their center position, the main mix is also present on the monitor bus, giving you the opportunity to control the volume settings individually from the stage. The overall volume of the monitor mix is set with the AUX3 fader in the master section. If you are using this option you have to keep in mind that all volume changes made with the channel faders also appear in the monitor mix, leaving you with a higher risk of acoustical feedback.

To reduce the risk of feedback, you still have the option to adjust the individual send levels via the channels' AUX3 rotary controls. There is even the possibility to cancel some loud instruments – like the kick drum or the snare drum, which are in fact already loud enough on-stage – totally from the monitor mix by turning the corresponding controls all the way to the left.

**10. PAN**

This control determines the position of the connected sound source within the stereo image. When this control is set at its center position, the audio signal is fed equally to the left and the right master busses. Through the extensive PAN section circuitry the essential sound pressure level always stays the same, no matter to what position within the stereo image the PAN control is set.

**11. PFL**

Engaging the PFL button (Pre Fader Listening) routes the audio signal of the corresponding channel to the headphone bus. In this way you can route as many signals as you want to the bus at the same time. The volume levels of the individual signals are not affected by the channel fader settings – PRE FADER LISTENING. This gives you the opportunity to set the level or the EQ of a channel without the need to include it in the main mix. The overall signal of the headphone bus is present at the headphone output.

**12. SIGNAL (present) / PEAK indicator**

These indicators play a key role during the level adjustment of the input channels, offering visual confirmation of the actual signal level. They provide the possibility of detecting the risk of overdrive before you would actually hear the distortion, unlike the mixers of many other manufacturers that either only provide a PEAK indicator or no channel indicator at all.

As described before, the signal “present” LED should blink in the rhythm of the incoming signal. If this is not the case, you should increase the gain. If the PEAK LED blinks frequently or lights up constantly, the corresponding channel is likely to enter clipping and you should turn the gain control a bit to the left. The signal “present” LED lights at levels –30dB below clipping while the peak LED lights at a level of –6dB below the occurrence of overdrive. It is also a good idea to watch the indicator during a performance. During performances, some musicians get carried away by the music and the atmosphere and tend to play their instruments more dynamic than during the rehearsal. This, of course, can easily lead to channel clipping, resulting in degradation of the sound.

**13. VOLUME**

The channel faders are used to set the volume of the corresponding channels and to establish an accurately proportioned mix. The channel faders should be positioned within the range of –5dB to 0dB, leaving you with a degree of control that allows the precise matching of relatively large differences in the channels' level settings. The overall volume is set through the use of the master faders.

Even though the channel faders offer an additional gain of +10dB, we would recommend that you not exceed the +5dB mark. If the PSX's main bus gets “overloaded” with too many “high level” input channels, despite its special negative gain structure, the summing amplifier could be driven into clipping. Once you reach a level where some channel faders are set above the 0dB marking, we would recommend you lower the setting of each channel fader by about –5dB and increase the overall output level by elevating the master faders. The proportion of the mix and the overall volume stay the same while the risk of clipping is prohibited.

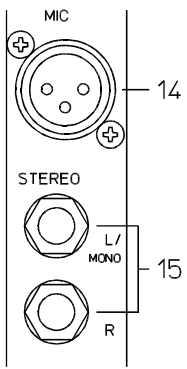

Since most features of the stereo inputs are virtually identical to those of the monaural inputs, we will not discuss their functions in detail again. Thus, we only point out the differences and ask you to refer to the paragraphs in the first chapter of this owner's manual.

## 14. MIC

Like their monaural counterparts the stereo input channels of the PSX incorporate extensive circuitry and electronically balanced XLR-type connectors for the connection of low impedance microphones. Whether your setup is more microphone-oriented or you have more line level sound sources to connect, you can always use the full amount of input channels, provided by your PSX. The functioning principles were already discussed in detail in the previous chapter.

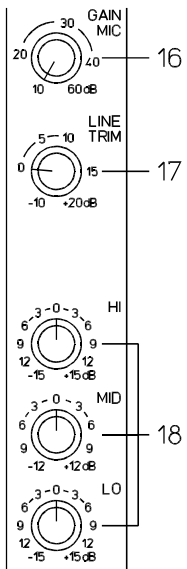
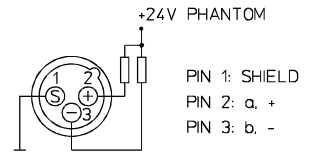

## 15. STEREO INPUT L/MONO R

Electronically balanced inputs for the connection of musical instruments with stereo output, like keyboards and drum machines, Electric guitars and basses with an active outputs, as well as all other equivalent sound sources with high level outputs, like additional mixing consoles, FX units, CD players, etc. The stereo LINE input is meant for balanced or unbalanced sources with levels between  $-20\text{dBu}$  and  $+30\text{dBu}$ . For the connection of external devices you can use monaural or stereo phone plugs which are in accordance to the diagram below. If the external device is equipped with a balanced output stage, you should preferably use balanced cables and plugs, since this type of connection provides better shielding against HF induction and external noise.



In case you want to connect a monaural source to a stereo input channel, plug it into the L/MONO input. The signal gets internally routed to both channels. For further information, please refer to the chapter "INPUT/MONO".

## 16. GAIN MIC

Rotary control to adjust the MIC inputs' sensitivity, providing the possibility to optimally match the incoming signals with the mixer's internal operation level. The MIC GAIN control is only active for the XLR-type connections of the stereo input channels.

Adjustment and functioning of these controls are identical to those of the monaural inputs.

**CAUTION:** The MIC GAIN control of an unused microphone input should always be set to its minimal marking. Otherwise the noise of the inactive input is added to the audio signal of the corresponding LINE input, which could lead to unnecessary extra noise at the main output, becoming clearly audible in program breaks.

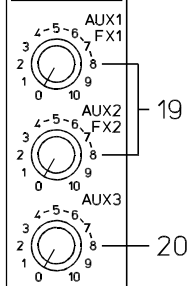

## 17. LINE TRIM

These rotary controls are used to match the incoming line level signals with the operational level of the PSX. The total adjustment range is 30dB. Unity gain – no amplification (0 dB) – is achieved at the 0dB mark. The control offers a level reduction of the incoming signal by  $-20\text{dB}$  and an amplification of  $+20\text{dB}$ . This range is wide enough to allow the connection of most professional, semi professional, and even hi-fi audio sources.

For further details on how to adjust the LINE TRIM control, please refer to paragraph 4. GAIN.

If you use a keyboard as sound source on one of the stereo inputs, make sure that no split zones or layers with channel separation are activated. Otherwise the stereo channel mapping will appear like it is set on the keyboard and you will not have the opportunity to re-position the sound in the overall stereo image, using the controls of the mixer. The better alternative to connect a keyboard with pre-programmed channel mapping is to use two adjacent monaural input channels, leaving you the option to place the sound in the final mix via PAN controls.

**One more tip**, in case you desperately need another input and all channels of the PSX are already in use:

The microphone input and the phone plug-type inputs are electrically separated from each other. Each input is equipped with its own gain control – respectively trim control, providing you with the possibility to connect a LINE level source in addition to a microphone. Of course, the two sources share all other controls. Consequently, separate adjustments are not possible. This option is only meant as a subsidiary function and can be used when there is absolutely no other alternative.

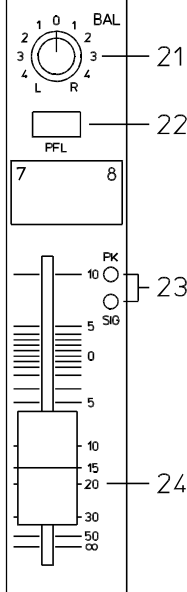



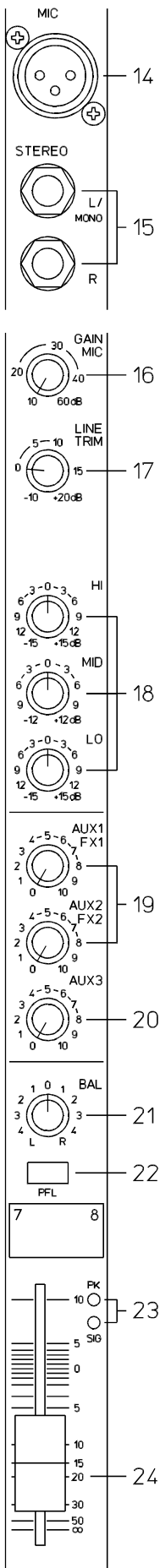

**18. EQ SECTION**

The mixer's EQ section allows very differentiated shaping of the incoming audio signal within miscellaneous frequency bands. Turning one of the EQ level controls to the right enhances/amplifies the corresponding frequency range while turning them to the left lowers/attenuates the signal of the specific frequency band. Before you begin to alter the sound, all EQ controls should be set to their neutral position; that is: their marker points straight up (locked in place). Try to avoid setting EQ controls to extreme positions. Usually, minor changes are totally sufficient and produce the best results in the overall sound. You should use the natural reproduction as an orientation mark and rely on your musically trained ear to judge the sound quality. The moderate use of the MID control is the best remedy to avoid acoustical feedback. In this frequency range, you should try to avoid excessive enhancement. Lowering the level in this band will provide you with high amplification rates without feedback.

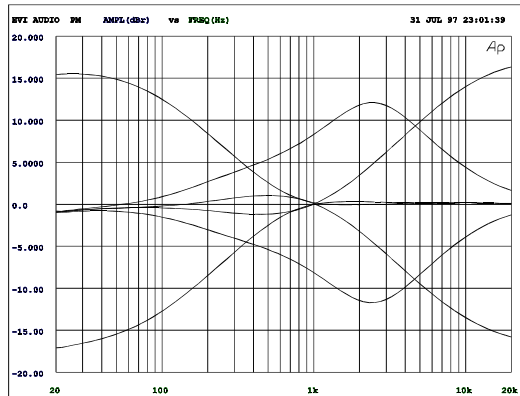

The HI and LO controls of the STEREO channels' EQ section provide a degree of control that is equally adequate for LINE level inputs and microphones. The MID control is active in a comparably wide frequency band around 2.4 kHz. With most microphones this is the critical range, where a slight attenuation offers excellent results.

**19. AUX/FX**

These controls determine the amount of the summed L/R signal that is send to the AUX/FX bus. The signal routing is POST FADER. For more details on the functioning of these controls, please refer to the INPUT/MONO section of this owner's manual.

**20. AUX3**

This control determines the amount of the summed L/R signal that is send to the AUX3 bus. Depending on the setting of the AUX3 POST switch within the PSX master section you can choose if the signal is routed PRE or POST FADER.

**21. BAL**

The function of the BAL control of the stereo channels is equivalent to the PAN control's function of the monaural channels. If you turn the rotary control all the way to the right, the signal is routed to the right output while the signal of the left channel is muted. When the control is set to its center position, the signal is present with equal intensity at the corresponding L/R outputs. Whenever stereo sound sources are connected to a stereo channel, you should leave the BAL control at the center position or make only minor adjustments in either direction. In case a microphone or another monaural sound source is connected, the BAL controls function absolutely identical to the PAN controls of the monaural input section.

**22. PFL**

Engaging the PFL button routes the audio signal of the corresponding input channel to the headphone bus where the stereo signal is outputted to the headphone output. You can route as many channels as you want to the bus at the same time. The volume levels of the individual signals are not affected by the setting of the corresponding channel faders – PRE FADER LISTENING. This gives you the opportunity to set the level and the EQ of a channel without the need to include it in the main mix.

**23. SIGNAL/PEAK**

For the stereo SIGNAL/PEAK indicator function, the left and the right channels are monitored separately. The respective highest level reading is indicated, assuring that neither one is already driven into clipping. For further descriptions on how to use this indicator most efficiently, please refer to paragraph 12 of the previous chapter.

**24. VOLUME**

The channel fader is used to simultaneously adjust both channels of the stereo signal. Functioning and specifications are totally similar to the monaural channel fader, as previously described.

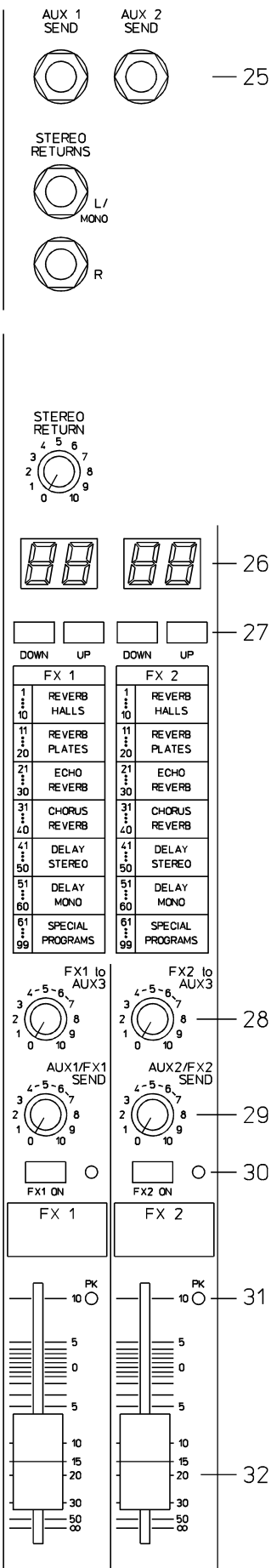

**FX1/FX2**

The PSX offers two independent, identically-configured 18-bit stereo effect units – FX1 and FX2. Each unit provides 99 program presets which are selected by the use of the UP/DOWN buttons. The presets are divided according to the different effect types into seven different groups which are shown on the printed labels. The programs within each preset group are sorted in ascending order where higher numbers provide the same FX type with increased intensity. The presets 1 - 20 offer high quality reverberation effects that are equally suited for the use during live performances or your home recording environment. The program numbers 21 - 40 provide mixed effect types of echo/reverb, chorus/reverb and flanger. Numbers 41 - 60 offer different delay effects. The last group from 61 - 99 provides different reverse, chorus, and doubling presets as well as special delay and reverb programs. During the initialization of the FX units, when turning the PSX's power on, the preset 05 (Large Hall 3 Bright) is selected for the FX1 while the FX2 unit is set to preset 55 (Delay Mono 250ms). These two effects are similarly suitable for live performances and recording applications. They can be used separately or together. Please, also refer to the supplementary information form "EFFECT PRESETS" for a more detailed description of all effect presets. This list contains all preset groups together with the corresponding program profiles, their individual characteristics, and a description on how and in what combination to use them. Take your time to test all presets and select the ones that are best suited for your specific application.

The preset 0 is a slap back echo which is mainly used for service and testing of the effects section and it doesn't appear on the list at the panel.

The FOOT SWITCH connector is provided to allow the connection of a foot switch pedal to remote control the FX units' EFFECT ON/OFF function. If your foot switch features a LED – like the EV FOOT SWITCH does – this indicator will light when the effect is activated.

FX1/FX2						
1.....10	11.....20	21.....30	31.....40	41.....50	51.....60	61.....99
REVERB HALLS	REVERB PLATES	ECHO REVERB	CHORUS REVERB	DELAY STEREO	DELAY MONO	SPECIAL PROGRAMS

**25. AUX1/2 SEND**

These jacks are meant for the connection of external FX units, providing the signal mixes that you have established for the AUX/FX buses – the identical mixes which are fed to the internal FX1/2 units. The output level is controlled using the corresponding AUX/FX SEND controls. The external devices' output signals can be send back to the PSX via the stereo return bus or by using stereo input channels.

The AUX1/2 sends are designed with Ground Sensing technology to prevent the induction of external noise, even when longer cables are used.

**26. DISPLAY**

The actual selected effect number is displayed.

**27. UP/DOWN buttons**

The UP/DOWN buttons are used to select the effect presets. Keeping a button pressed constantly lets you step quickly through the program numbers.

**28. FX to AUX3**

These controls allow to mix the FX1/2 output signals with the AUX3 signal. In case you are using the AUX3 bus for monitoring purposes, you are able to add the FX signals at the desired level to the monitor mix. Experience in mixing has shown that the effect level in the monitor mix should be lower than the level in the main mix. R

**29. AUX/FX SEND**

These rotary controls could also be called FX SEND master controls, since they are used to adjust the overall level of the effect mix that you have established using the channel FX send controls. The AUX/FX SEND controls are used to set the input levels of the corresponding FX unit, respectively and the levels of the AUX SEND outputs. Whenever the Peak LED (PK) blinks, there is the potential risk that the FX input signal is driven into clipping, making it necessary to reduce its level by turning the corresponding AUX/FX SEND control to the left, until the LED is not lit anymore. Since the AUX/FX SEND controls not only affect the signals of the FX buses but also the monitor effect level, which is sent by the FX to AUX3 control, careless changes can result in acoustical feedback.

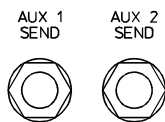

— 25

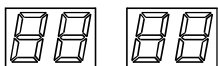
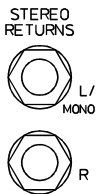

— 26



— 27

FX 1		FX 2	
1 10	REVERB HALLS	1 10	REVERB HALLS
11 20	REVERB PLATES	11 20	REVERB PLATES
21 30	ECHO REVERB	21 30	ECHO REVERB
31 40	CHORUS REVERB	31 40	CHORUS REVERB
41 50	DELAY STEREO	41 50	DELAY STEREO
51 60	DELAY MONO	51 60	DELAY MONO
61 99	SPECIAL PROGRAMS	61 99	SPECIAL PROGRAMS

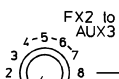
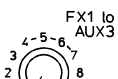

— 28

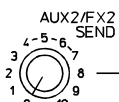

— 29

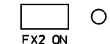

— 30

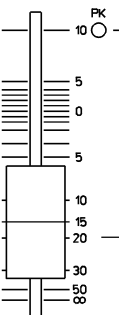
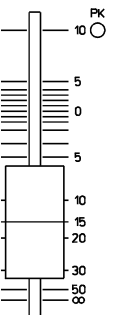
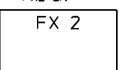
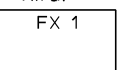

— 32

### 30. FX ON

These switches are used to turn the internal FX units on – the green LED is lit. Please keep in mind that you also can use an external foot switch to turn the FX units on. In this case the LED also shows the actual state of operation. If you want to use a foot switch, the FX ON switch has to be engaged first. The corresponding FX unit is activated and you can use the foot switch to turn the selected effect program on or off.

### 31. PEAK LED

These indicators show if the input stages of the internal FX units or the AUX 1/" SEND signals are driven into clipping. To achieve an adequate S/N ratio, please adjust the FX units' input level as follows:

#### Note on how to adjust the FX input signal:

1. Establish a "dry" mix – without effect settings – according to the previous descriptions.
2. Set the AUX/FX send controls of the effect channels to their center position.
3. Position the effect return faders of the effect channels at the –5dB marks.
4. Use the UP/DOWN buttons to select the desired FX program preset.
5. Press the FX ON switch.
6. Play the sound source of the desired input channel and adjust the desired amount of the FX signal, using the AUX/FX controls of this input channel. Repeat this step for all input channels that you want to include in your effect mix.
7. Adjust the AUX/FX SEND controls, so that the Peak LED only lights frequently at highly dynamic signal peaks.
8. Use the FX to AUX3 control to add the effect mix to the monitor mix. Use the FX return faders to add the desired amount of the FX signal to the main mix.

In case you are using a different effect setting for the second FX unit, you have to repeat the step 2 - 8, respectively. Pay some attention to the peak indicators when operating your PSX to quickly interact when the signal levels exceed the normal range and enter clipping.

### 32. EFFECT RETURN

These stereo faders are used to determine the effect amount of the main mix. In case you have to set these faders at a position above the +5dB mark, please check if the FX units input signals are adjusted properly. Otherwise use the AUX/FX SEND controls to increase the input levels.

Typically, the AUX3 channel is used as monitor bus. Depending on the setting of the AUX3 POST switch, it is also possible to configure the bus for the connection of an additional, external FX unit.

**33. AUX3 SEND**

This output is meant for the connection of an external FX unit, a power amplifier or active stage monitor speaker systems, when the AUX3 bus is used for monitoring purposes. Using the AUX3 fader, the output level can be adjusted over a wide range up to +20dBu. The AUX3 send is designed with Ground Sensing technology to prevent the induction of external noise, even when long cables are used.

AUX 3 SEND



33

**34. FEEDBACK FILTER**

The feedback filter is a very narrow band notch filter which is only active over a range that is extremely susceptible to acoustical feedback. The frequency band is set using the corresponding rotary control. The filter is activated by pressing the corresponding ON switch. Acoustical feedback occurs when the sound system becomes the largest acoustical source at a microphone. Or in other words: the speaker signal hits the microphone and gets amplified again and again, resulting in escalating oscillation, and is audible as a high pitched whistle or loud humming sound. The following guidelines are meant to assist you in avoiding feedback and you should take them into consideration even before you activate the feedback filter.

1. Do not position the main speaker systems behind the microphones.
2. Turn off all unused microphones.
3. Also consider the microphones' different polar patterns and characteristics, when placing the monitor speakers.
4. Do not turn up the monitor system's volume higher than really necessary.
5. Try to avoid extensive equalization on channels that you want to include in your monitor mix.
6. Keep in mind, that microphones "behave" different when somebody stands right in front of them. In fact, the amount and intensity of first reflections changes things drastically.
7. Position the microphones as close as possible to the sound source.

If you still need more volume from the monitor system, after trying the above mentioned precautions, you can use the feedback filter to notch the frequency that tends to affect feedback the most. Therefore, you need to perform the following steps:

Increase the AUX3 (monitor) level until the point where feedback starts. The "sound" you hear is generated within the system. Turn on the feedback filter and adjust the rotary control at the point where the "ringing" disappears. Switching the filter on and off lets you easily check if you tuned in the correct frequency. The feedback filter attenuates the corresponding frequency band by about 9dB. Since the filtered band is extremely narrow, an alteration in the sound of your monitor system is hardly audible.

**CAUTION:** Please be extremely careful when you increase the level up to the feedback limit. Careless operation, resulting in feedback at high SPL, can severely damage your speaker systems and – even more important – the human ear.

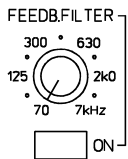

34



35



36

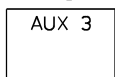

**35. AUX3 POST**

As mentioned before, this switch determines if the AUX3-mix signal is PRE or POST FADER. When the switch is engaged and the yellow LED lights, the signals of all AUX3 controls in the input channels are sent after their corresponding channel faders.

**36. PFL**

With this button you can route the pre-fader AUX3 signal to the headphones bus. The signal is outputted via the headphone output. The setting of the AUX3 fader is not relevant for the signal's volume (PRE FADER LISTEN), leaving you with the opportunity to adjust its level and equalization without the need to route it to the AUX3 SEND bus.

**37. AUX3 VOLUME**

This fader controls the AUX3 SEND output level. When the AUX3 bus is used for monitoring, this fader lets you control the volume of the monitor system.

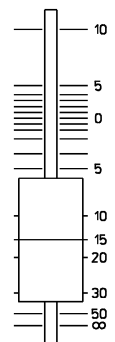

37

**38. MONO OUTPUT**

At the monaural output the summed L/R signal of the master is present. It can be used for additional monitoring, side fill and "next door" applications, or to establish a delay-line.

**CAUTION:** The outputted signal is not only affected by the setting of the MONO OUT fader but also by the MASTER faders' setting.

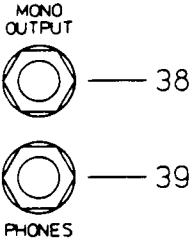

**39. PHONES OUTPUT**

Stereo phone jack for the connection of headphones with an impedance of 32 – 600 ohms. The audio signals of the channels where the PFL button is engaged is outputted via this connector.

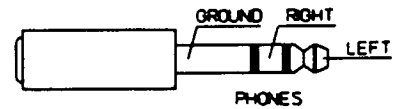

**40. PHONES LEVEL**

This control is used to adjust the headphone's volume.

**CAUTION:** Adjust this control at its minimal setting before connecting the headphones.

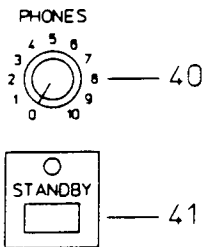

**41. STANDBY**

Pressing the STANDBY button mutes all outputs to which amplifiers could be connected to the PSX. Because the signal flow between the MAIN INSERTS and the MAIN OUTPUTS is interrupted, the internal power amplifier's signal is also muted. The STANDBY LED indicates that the stand-by mode is engaged and the input channel signals are not heard over the speaker systems. But, the 2Track Return signal is still fed to the power outputs, providing you with a very comfortable solution to play intermission music during performance breaks.

**42. MONO MASTER VOLUME**

This fader controls the output level of the MONO OUTPUT. The output level is also influenced by the setting of the MASTER faders (post fader).

In case a PRE FADER signal split would provide the better solution for your application, this can be achieved by some minor internal changes.

Please consult your dealer for assistance.

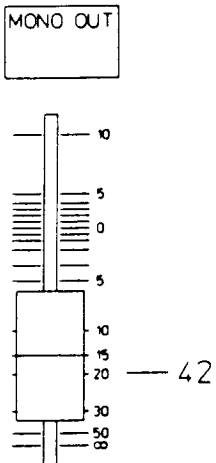

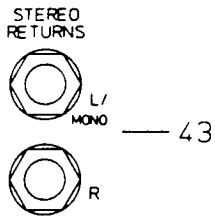

**43. STEREO RETURNS**

The stereo returns are used to route stereo signals (signal from an external mixer, FX unit, CD player, keyboard etc.) to the master output.

In case you want to connect a monaural device, please use only the L/MONO return connector. A monaural signal is internally routed to both channels.

**44. STEREO RETURN**

Rotary control for level adjustment of the signals coming in the STEREO RETURNS. The signal level is also influenced by the setting of the master L/R faders.

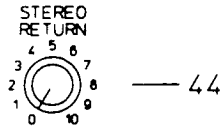

**45. RECORD SEND L/R**

These RCA-type connectors carry the PRE-FADER master L/R signal. The signal is not affected by the setting of the master faders and is mostly used for connection of cassette decks, open reel tape decks or DAT recorders for recording purposes. The nominal level of the outputs is -10dBV to prevent overload when used with consumer tape decks. Nevertheless, you should use the input gain control of your recording device to avoid overload and to insure adequate signal level.

**CAUTION:** On most tape decks, the incoming signal is routed to the outputs. If you connect the REC. SENDS and the 2-TRACK RETURNS with the PSX's 2-TRACK to MASTER control set to anything but its lowest setting, the recorded signal will be included in the main mix again. The difference in delay of the two signals will create drop-outs and general degradation of the sound. In the worst case, activating the RECORD button on your tape deck could lead to very unpleasant feedback noise. To prevent this from happening make sure that you always have the 2-TRACK to MASTER control and the AUX3 control adjusted to their lowest settings when recording.

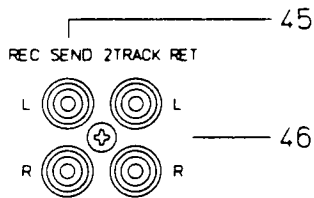

**46. 2-TRACK RETURN L/R**

Here you can connect a tape deck, a CD player, an open reel or an additional mixer. The signal is post master fader and post STANDBY switch, providing you the capability to play intermission music during performance breaks or check the mix during the rehearsal by using the headphones. You just have to engage the STANDBY switch to mute all channel signals at the main outputs and the monitor bus.

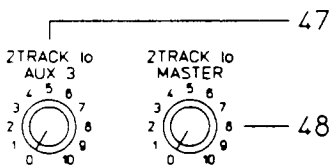

**47. 2-TRACK to AUX3**

The signal coming from the 2-TRACK RETURNS is internally added to the AUX3 bus (monitor bus) and its level is set with 2-TRACK to AUX3 rotary control. The signal is added to the bus pre-2-TRACK to MASTER control.

**48. 2-TRACK to MASTER**

This control is used to mix the 2-TRACK signal to the main mix post-fader of the master L/R controls. **CAUTION:** When adjusting the level of the device that is connected to the 2-TRACK RETURNS – CD player, tape deck, etc. – always begin with the 2-TRACK to MASTER control adjusted at its minimal setting. Otherwise, depending on the quality and level of the connected source, the outputted volume can instantly “hit the top”.

### 49. MAIN INSERTS

Stereo phone jacks for the left and the right channels with breaker function. The low impedance output is assigned to the tip (send) and the high impedance input (return) is assigned to the ring of the connector. This jack allows the connection of external EQs, compressors, limiters, etc. into the master L/R signal path. The insertion point is pre-master faders. As with the inserts of the monaural input channels, different DIRECT OUT functions can be accomplished.

Please, also refer to the corresponding section in the description of the MONO INPUTS.

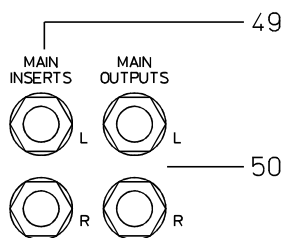

### 50. MAIN OUTPUTS

The signals at the MAIN OUTPUTS are post master fader and mainly meant to feed additional, external power amplifiers. Through these outputs, it is also possible to run a two-way active system set-up. In this case, the active crossovers – or active subwoofers have to be connected to the MAIN OUTPUTS. If you want to use the internal power amplifier to supply the high frequency cabinets, the high-frequency signal coming from the crossover has to be run back into the PSX via the POWER AMP INPUTS.

### 51. EQ INPUTS / OUTPUTS

The EQ INPUTS are provided through electronically balanced phone jacks with breaker function. When inserting a phone plug, the signal path is interrupted between the master L/R controls and the internal power amplifier. The EQ INPUTS and POWER AMP INPUTS are the only active inputs for the internal power amplifier.

The signals at the EQ OUTPUTS are post-master fader and post the internal 7-band equalizers. Likewise, the MAIN OUTPUTS can be used for connecting external devices.

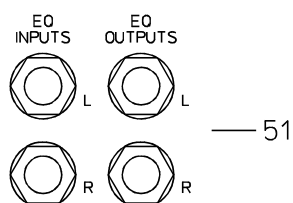

### 52. POWER AMP INPUTS

The POWER AMP INPUTS are also provided via electronically balanced phone jacks with breaker function. When inserting a phone plug, the signal path is split between the master and the internal power amplifier. The POWER AMP INPUTS are then the only active inputs for the internal power amplifier.

**NOTE:** For detailed information on the function and operation of the “MASTER PATCHBAY” – MAIN INSERTS, MAIN OUTPUTS, EQ IN/OUTPUTS, and POWER AMP INPUTS – please refer to the corresponding section; later in this owner’s manual.

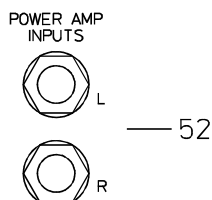

### 53. FX1/2 FOOTSW.

Phone jack for the connection of the foot switch or other compatible unit, to switch the internal FX units on or off.

To accomplish this function, the switches FX1 and FX2 have to be engaged.

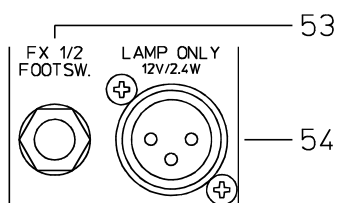

### 54. LAMP

This XLR-type socket provides a DC voltage of 12V /2.4 watts and is meant for the connection of a gooseneck lamp. Please make sure that the lamp used complies with the specifications and pin assignment, shown here. **CAUTION:** Overload or short circuits can result from damaging this output. To prevent this from happening, we recommend the use of a Littlelite gooseneck lamp, available from your Electro-Voice dealer.

For further information, please consult your dealer.

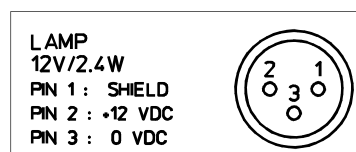

**55. POWER AMP STATUS indicators**

These indicators inform you about the momentary operational status of the PSX's internal power amplifier.

The **POWER ON** indicator is always lit when the PSX is in operational mode. If the LED is not lit after you have turned the power on, please make sure that the PSX's power cable is correctly plugged in. If this is the case and the LED is still not lit, please contact your dealer.

The **LIMIT** indicator signals that you are operating the PSX at the internal amplifier's limit. Frequent blinking of the LED is acceptable, since the amplifier's incorporated limiter prevents serious distortion. Continuous illumination indicates that you should be aware of a degradation in sound quality. In that case, the master level should be reduced.

The **PROTECT** indicator is lit when one of the PSX's extensive protection circuits is guarding against thermal overload, HF-induction, DC at the outputs, or short circuits is activated. When the PSX is in protect mode, the speaker outputs are muted and the amplifier's inputs are shorted to prevent the amplifier from being damaged. In this case you should first check to see if the ventilation louvres are blocked. Another cause could be that you have more than three 8 ohm speaker systems per output channel connected. You should also disconnect the SPEAKON output connectors and check the speaker cables for short circuits.

During normal power-on operation, the PROTECT LED always lights for about two seconds, signaling that the PSX's protection circuitry is operational.

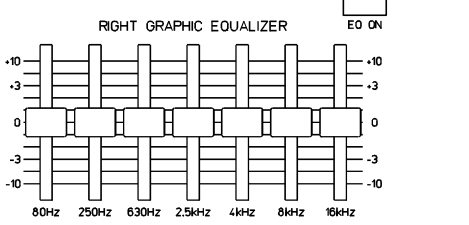
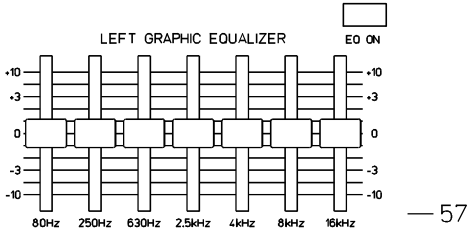
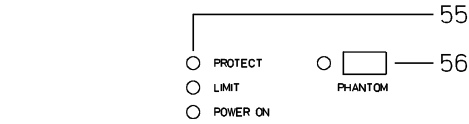

**56. PHANTOM POWER**

When this switch is engaged, all MIC inputs are supplied with +24V phantom power. Please make sure prior to engaging phantom power that the PSX is switched off or in stand-by mode. With active phantom power the connection of unbalanced signal sources (keyboards, mixer, etc.) to XLR inputs is not advisable, because this could lead to severe damaging of your equipment.

**ATTENTION! IMPORTANT NOTICE!**

In general, the operation of phantom-powered condenser microphones and balanced dynamic microphones at the same time does not lead to any problems.

Nevertheless, some balanced dynamic microphones are extremely sensitive to this. Some models could get damaged when used on mixers with active phantom power. Please refer to the microphones' owner's manuals to make sure that this operation is permissible.

To be on the safe side, you should switch the PHANTOM POWER off, when using balanced dynamic microphones, only.

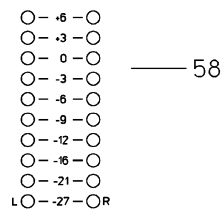

**57. 7-BAND EQUALIZER**

The respective EQ ON switches activate each 7-band graphic EQ within the PSX's master section. The EQ's insert point is post master fader and pre internal power amplifier. The EQ is bypassed when the EQ ON switch is not locked in its "ON" position. The two graphic EQs provide seven frequency bands, each. Through these faders you are able to match the overall sound optimally to the acoustic conditions of different locations or shape it according to your personal taste. Each frequency band allows ±10dB equalization in the corresponding range with a Q=1.4.

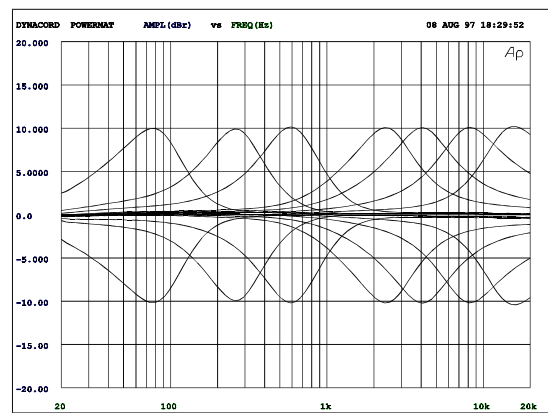
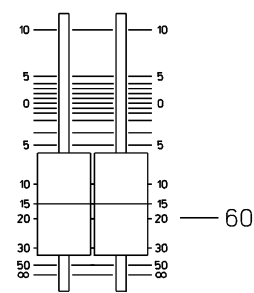
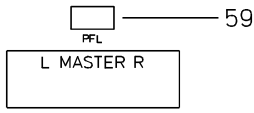



The frequency ranges and the characteristics of the of the equalizer were carefully chosen for live sound. If you want a clear and intelligible sound, which also provides cymbals and other instruments with added high frequency detail, you should raise the levels of the 8kHz or 16kHz bands a bit. If the mids sound too nasal, you should attenuate the 1 kHz and 2.5 kHz frequencies a few decibels. To provide the kick drum or other bass instruments with more punch, you have to boost the low frequency range, using the 80Hz or the 250Hz controls. In case the overall sound is undefined with too much bass, lowering the levels of these two frequency bands will solve the problem.

When using the equalizer, you should be aware of the fact that in most cases less adjustments (especially boosting) provides better results. Thus, your first choice should be to establish the mix using only the input channel EQs to see if you can get satisfactory results. If so, you can use the graphic EQ for the AUX3 (monitor), where in most cases it is more needed. You will find the description of how to include the graphic EQ in the monitor bus later in this owner's manual.

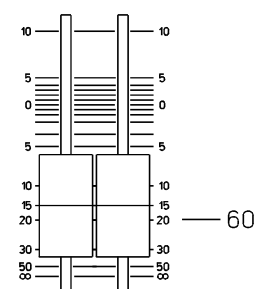
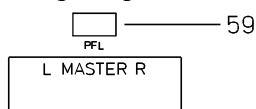
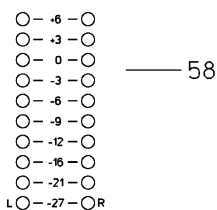
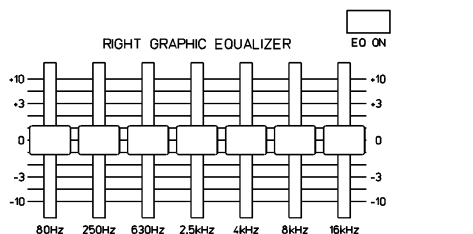
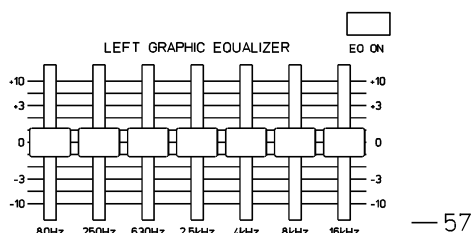
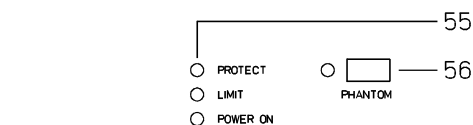

### 58. MASTER LED-DISPLAY

The PSX offers two 10-segment LED ladders to monitor the output levels of the L/R master signals. The indication range of the LED-meter is 33dB, displaying the levels in dBu which are present at the EQ OUTPUT and the POWER AMP INPUT. The meter's 0dB mark is referenced to a 0dBu output signal at the POWER AMP INPUT. Increasing this level leads to the power amplifier's maximum input level of +6dB – equaling an output power of 500 watts at 4 ohms per channel. Higher levels are not displayed, since the amplifier's processor limits the signal at this point. When the LIMIT LED of the status indicator section lights, this shows that the internal limiter is activated.

### 59. PFL MASTER

When the master PFL button is engaged, the PRE FADER stereo master signal is routed to the headphones output. The volume of this signal is not affected by the setting of the MASTER faders.

### 60. MASTER L + R

Level controls to adjust the output signals of the left and right main outputs (MASTER).

**Please make sure that the corresponding input channel fader or the master faders are set to their minimum position or the STANDBY switch is engaged, before connecting an external source to an input of the PSX. This will save you, your audience, and speakers from unnecessary stress.**

### POWER AMPLIFIER

The PSX's PROCESSOR-CONTROLLED stereo power amplifier's design uses bipolar output devices to provide a nominal output power of 500 watts at 4 ohms per channel. The minimal load impedance of 2.7 ohms allows the operation with a maximum of three paralleled 8 ohm loudspeakers connected to each channel. Their low distortion provides the amplifier of the PSX with outstanding sound quality that welcomes comparisons with the best professional high-end, stand-alone audio power amplifiers.

The amplifier is also designed to handle the wear and tear of touring operation. It incorporates protection against thermal overload, short circuit, HF-interference or the occurrence of DC at the outputs. Further protection against dangerous back-EMF is provided by a special circuit. When the PSX is switched on, a relais control switching on of the power outputs. The internal fans run shortly on full speed, signaling acoustically that the PSX is operational. A limiter controls the initial current inrush, preventing the mains fuse from being blown during power-on.

The extensive comparator circuitry constantly monitors the input and output signals and activates the internal limiters whenever a non-linear operational state is encountered. This provides reliable protection of the connected loudspeaker systems against overload and clipping. Even when the maximum input level is overridden, no distortion is heard on the speaker outputs. The amplifier also incorporates EVI Audio-patented processors to eliminate transient problems of typical sound reinforcement speaker systems and provides extraordinarily precise and powerful reproduction of low frequencies.

## REAR PANEL

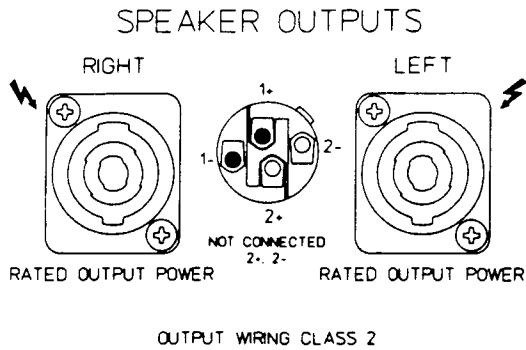

### SPEAKER OUTPUTS RIGHT / LEFT

The PSX is equipped with professional SPEAKON connectors, offering an electrical and mechanically secure connection which complies with all security regulations. It also allows the use of high quality speaker cables up to 4x AWG 13.

If your speaker cabinet is equipped with phone jack sockets, please ask your local EV-Dealer for the correct cable.

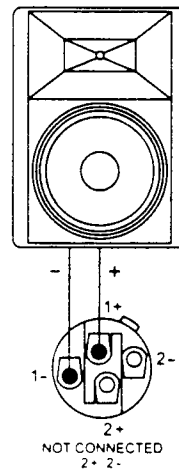
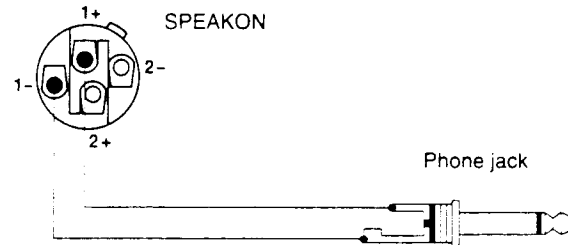

### POWER

mains switch to turn the PSX on or off.

The PSX is operational when the POWER ON indicator is lit and the power outputs are activated.

**Please make sure to set the master faders to their minimal position or engage the STANDBY switch before turning the power on. This will save you, your audience, and the equipment from any extraneous noises.**

In case additional external equipment is connected to the PSX – e. g. FX units, power amplifiers, EQs, etc. – please, proceed in the following order when switching your equipment on:

1. FX units
2. PSX
3. external power amplifiers

When switching the power off, please proceed in the opposite order.

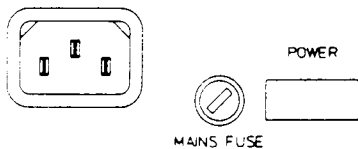

**CABLING**

The ac power cord comes with the PSX. The quality of all other cables are your responsibility. Carefully chosen high quality cables are the best precaution to prevent problems during operation. The following wiring alternatives are recommended to provide a trouble free operation of your setup.

**SPEAKER CABLES**

From our experience as a manufacturer of loudspeaker systems we've learned that flexible speaker cables with a rubber jacket (10 - 16 gauge, depending on length) used in combination with NEUTRIK SPEAKON plugs and sockets, are the best choice to guarantee optimal connection of loudspeaker systems. In accordance to the corresponding diagram, the SPEAKON plugs are connected on the PSX rear panel. You can also consider the use of 4-wire cables where pins 2+ and 2- are also connected. This provides you with the possibility of using these cables with active 2-way system configurations, as well. Professional-quality speaker cables with SPEAKON connectors and all other cables, plugs, and sockets are available at your Electro-Voice dealer.

**LF-CABLES – BALANCED OR UNBALANCED?**

For all low current wiring, your best choice are balanced cables (2 signal conductors + ground shielding) with XLR-type connectors or with stereo phone jacks and plugs. The cables should be step proof, shielded, and never longer than really needed. Too many too long cables mostly lead to confusion and generate unnecessary problems.

Of course, you can also connect unbalanced cables with monaural phone plugs to the PSX's inputs and outputs and because of its superb grounding managing system in most cases no interference will occur. Still, there is a minimal risk that problems could arise and we believe that this is reason enough to keep on reading. Generally spoken, if you have the choice, a balanced LF-cable is always the better solution. Today's modern audio equipment – like amplifiers, equalizers, FX units, mixing consoles, and even some keyboards – offers balanced in- and outputs. In a balanced signal path the cable screen provides the gapless connection of all metal parts, offering efficient shielding against the induction of external noise. The balanced cabling in conjunction with the common-mode rejection of the PSX's input stage effectively eliminates even existing artifacts of interference. All inputs of the PSX provide balanced audio connections and high common-mode rejection. The mixing stage outputs – AUX, MAIN, EQ, etc. – are laid out in GND-SENSING technology – a special pin assignment of the output jacks, offering all advantages of the balanced signal transmission, but lets you also connect monaural phone plugs without a problem. Nevertheless – as mentioned above – when longer cables are involved, using stereo phone plugs and balanced cables are the better alternative. The diagrams below show the pin assignments of plugs and cables that are used with the PSX.

MIC INPUT

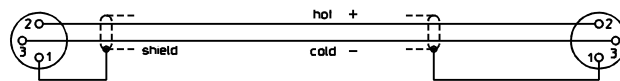

balanced connection of microphones

All phone jack in/outputs of the PSX

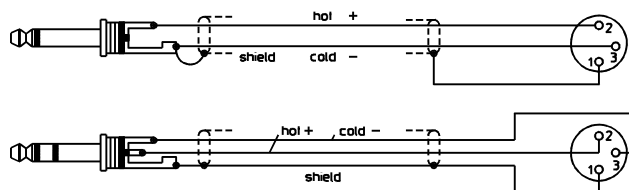

**unbalanced** external equipment with XLR-type in/output jacks  
**balanced**

Channel Insert  
Main Insert



Direct OUT via INSERT, uninterrupted signal path

All phone jack in/outputs of the PSX

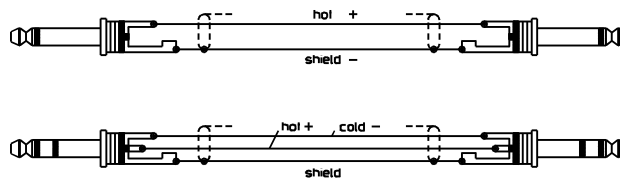

**unbalanced** external equipment with XLR-type in/output jacks  
**balanced**

Channel Insert  
Main Insert

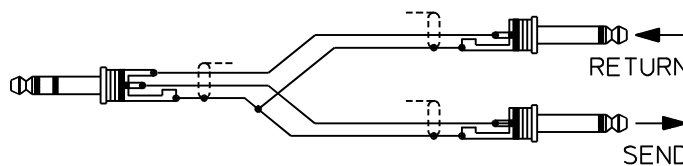

Y-type cable for the connection of external FX units and signal processors with phone jacks

## STANDARD INSTALLATION

In this chapter we would like to explain how to install a typical sound reinforcement system in passive configuration and incorporating stage monitor speakers. The necessary equipment is:

- 1 PSX
- 1 Power amplifier for the monitor signal
- 2 Speaker Systems
- 2 Woofer cabinets
- 2 Speaker stands or 2 pole mounts
- 2 Stage monitor speakers
- 4 SPEAKON cables (8m), and 2 SPEAKON cables (2m)
- 1 Balanced LF-cable with a stereo phone plug on one side and an XLR-type connector on the other side

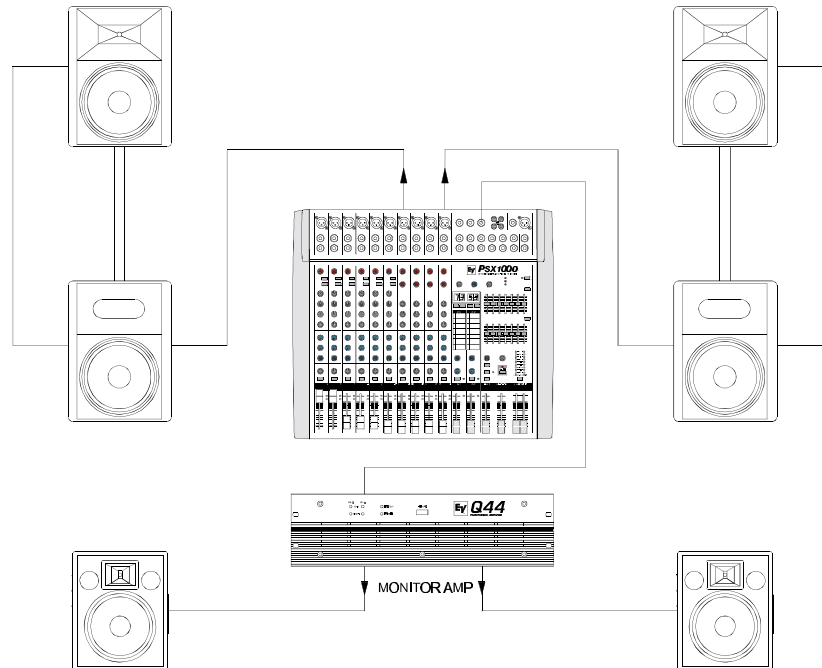

### Setting up

- Place the PSX and the external power amplifier in a way that allows their unobstructed operation during the sound check and performance.
- Try to locate the best position to place the loudspeaker systems. If possible, the woofers should be placed on the floor while the cabinets' most favorable position is above the woofer systems, on the same vertical axis. It is important that the lower edge of the hi cabinet is approximately at the same height level as the heads of the audience. Either use the pole mounts for the top of the woofers or, in case this kind of installation is not possible in your application, use separate speaker stands.
- Do not place the left and the right speakers further apart than necessary. The less distance there is between the two speaker "clusters" – the more impact to the sound.
- Try to avoid positioning the main loudspeakers behind the line of microphones. If you have to run the system at higher sound levels, the risk of feedback is very high.
- When the microphones are placed and all musicians ready, place the monitor speakers facing the musicians. Make sure no microphone is pointing directly into a monitor. You should also be aware of the individual characteristics of the used microphones.
- Make all connections according to the diagram above. Use the different SPEAKON cables to connect the speaker systems to the PSX's power outputs, respectively to the power outputs of the external amplifier. Make sure not to confuse the channels by accident. Using the short SPEAKON cables, you can connect the hi cabinets at the woofers' outputs. The two monitor speakers are connected to either output of the external amplifier. The amplifier should be run in a parallel mono configuration so that the amplifier's volume controls provide the capability to adjust the output levels separately.
- Connect the PSX's AUX3 SEND with the external amplifier's input, using a balanced NF-cable with the stereo phone plug on one end and the XLR-type connector on the other.
- Connect all microphones to the monaural inputs of the PSX and the keyboards and other comparable sound sources to the rest of the available inputs

- Pull all faders down and engage the PSX's STANDBY button to prevent unwanted feedback.
- First, switch the PSX on and then the external amplifier.
- In case you have condenser microphones connected to the PSX, you can now turn on the phantom power by pressing the PHANTOM switch.
- Activate the PSX's by pressing the STANDBY button again.

### SOUND CHECK

- First, adjust the input levels of the microphones that are connected to the PSX. Please proceed as follows:
  1. Set the corresponding gain controls and the channel faders to their lowest position.
  2. Speak or sing as loud as possible into the microphone.
  3. Use the gain control to adjust the level, so that even at loud passages the red PEAK LED is not lit but the green SIGNAL present LED lights constantly.
- Adjust the EQ of the monaural input channels:
  1. Slide the channel fader and the master faders up a bit, so that the sound is heard coming from the main speakers.
  2. Turn the MID control carefully all the way to the right (+15dB). You should not hear any feedback.
  3. Play the sound source or speak into the connected microphone.
  4. Turn the frequency control (kHz) slowly from left to right.
  5. You will detect the frequency range that is not to your liking or causing the feedback.
  6. Leave the frequency control in this position and turn the MID control to the left until the sound is natural or to your liking.
  7. If necessary, adjust the Hi and LOW controls, starting from their centered position, until the sound is pleasing to you.
  8. Repeat the steps 1 - 7 for all monaural input channels in use.
- In case you are also using the stereo input channels, you can adjust the levels in a similar way:
  1. Set the LINE TRIM controls, the MIC gain controls, and the channel fader to their lowest setting.
  2. Play the corresponding sound source at the highest volume that is to be expected during the performance.
  3. Use the LINE TRIM control to adjust the level, so that even at loud passages the red PEAK LED is not lit but the green SIGNAL present LED lights constantly.
- Adjust the EQ of the stereophonic input channels:
  1. Slide the channel fader and the master faders a bit up, so that you can hear the sound through the main speakers.
  2. Adjust the EQ controls at their center position.
  3. Play the corresponding sound source.
  4. Starting from the center position, you can adjust the controls until the sound is to your liking. Please, keep in mind that major alteration of the EQ-setting does not necessarily result in the improvement of the overall sound. Especially when sound shaping is concerned, less can be more.
  5. Repeat the steps 1 - 4 for all stereo input channels in use.
- If musical instruments are connected directly to the monaural inputs, follow the descriptions above for adjustment of the microphones.
- Make sure, that all channel faders, gain controls, and LINE TRIM controls of unused input channels are at their minimal setting. In this way you avoid unnecessary noise.

# STANDARD INSTALLATION

---

## MAIN MIX

- Position the master faders in the range between  $-30\text{dB}$  and  $-20\text{dB}$ .
- Establish a basic mix, using the channel faders, so that the individual sound levels relate to each other according to your personal taste.
- The best range for the channel faders to be set to is in the area of  $-5\text{dB}$  to  $0\text{dB}$ . In this way you are provided with enough tolerance for later adjustments.
- Use the master faders to adjust the overall volume.
- In case you are using the FX units, please proceed like this:
  1. Adjust the AUX1/FX1 send controls at their center position.
  2. Adjust the FX1 return fader at the  $-5\text{dB}$  mark.
  3. Use the UP/DOWN buttons to select the desired effect preset.
  4. Press the FX ON button.
  5. Play the sound source of the desired input channel and adjust the desired amount of the FX signal, using the AUX/FX controls of this input channel. Repeat this step for all input channels that you want to include in your effect mix.
  6. Adjust the AUX/FX SEND controls, so that the Peak LED only lights frequently at highly dynamic signal peaks.

If necessary, repeat steps 1 - 6 for the second internal FX unit (FX2).

## MONITOR MIX

- To successfully adjust your stage monitors, turn off your audience mix on the PSX but keep the on-stage mix alive.
- Lower the setting of the AUX3 fader within the master section.
- Engage the AUX3 POST button within the master section.
- Adjust the AUX3 faders of all input channels that are momentarily in use at their center position. In this way the main mix and the monitor mix are completely identical.
- Push the AUX3 fader up until low-level feedback is heard.
- Activate the FEEDBACK FILTER and adjust its control, so that the feedback disappears.
- Use the AUX3 fader to reduce the AUX3 level by about  $-6\text{dB}$ . This will provide you with enough "headroom" to avoid feedback during the performance, even when some microphone positions are changed for the worse.
- Use the FX to AUX3 control to add the effects mix to the monitor without influencing the main mix.  
Normally, the monitor mix uses a smaller amount of effects than the main mix.

Let the artists perform some and check the sound of the system from different angles and distances. If you come to the conclusion that some corrections in the overall sound are necessary, activate the 7-band equalizer and adjust the sound to your liking. By doing so, you should keep in mind, that during the performance the sound will be changed when the audience is present and has a major effect on the acoustical condition of the room, the degree of first reflections, and the absorption of low frequencies. If possible, you should check the sound "in the house" during the performance and – if necessary – adjust it to the changed conditions.

We wish you lots of fun and success with your new PSX mixer.

All inputs and outputs in the master section are referred to as the **MASTER PATCHBAY**.

The mixer's **LINE OUTPUTS**, **RETURNS**, and **INSERTS** are found here. To provide you with a wide variety of connection possibilities, the **MASTER INSERTS**, **MAIN OUTPUTS**, **EQ INPUTS** and **EQ OUTPUTS**, **POWER AMP INPUTS**, and the **AUX SENDS** and **AUX RETURNS** can be independently connected with each other or routed to external devices. In the basic configuration – when no plugs are inserted into any of the **MASTER INPUT** connectors – the signals are patched internally and fed to the internal power amplifier. Once you connect a plug to the **INSERTS**, **EQ INPUTS**, or the **POWER AMP INPUTS**, the internal signal path is interrupted, providing you with the opportunity to include external signals. We would like to show you some examples of how to use the **MASTER PATCHBAY**.

## 1. Connecting an external power amplifier:

If you need to connect more loudspeaker systems than the PSX is capable of handling directly or if you need more power, you have to use an external power amplifier. Using NF-cables with phone plug-type connectors, you can patch the signal either at the **MAIN OUTPUTS** – pre EQ – or at the **EQ OUTPUTS** – post EQ. In this configuration, the signal path to the internal power amplifier is not interrupted and the audio signal is outputted to the speaker systems connected to each amplifier.

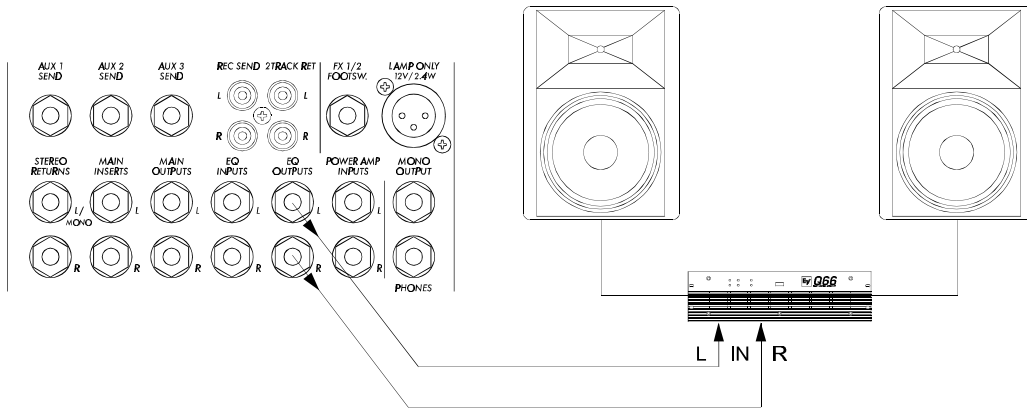

## 2. Connecting an additional mixing console:

If you need additional input channels, you have to connect an external mixing console. In doing so you can either use up another **LINE INPUT** of the PSX or – as shown in the diagram below – connect the external mixer to the **STEREO RETURNS**. In combination with the PSX's stereo return control, the latter solution offers the additional benefit of matching the level of the additional console to the PSX's operating level.

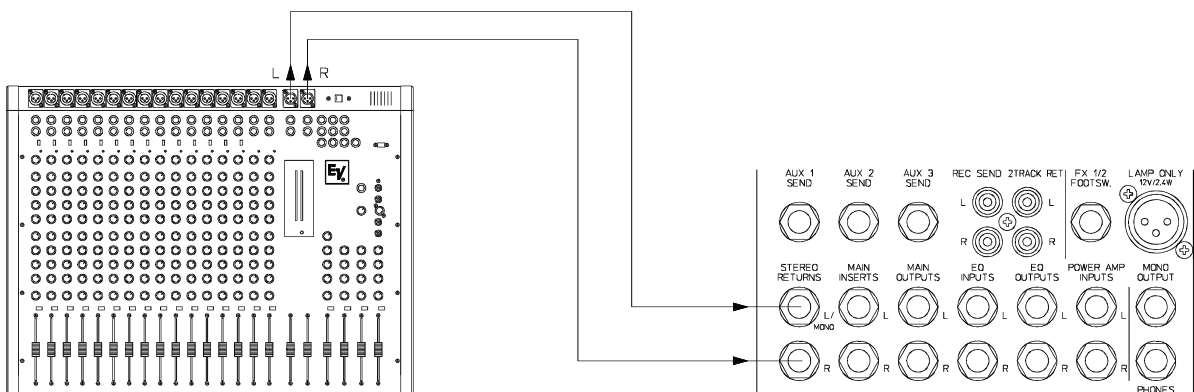

# MASTER PATCHBAY AND INSTALLATION ALTERNATIVES

## 3. Using the internal power amplifier for monitoring or side-fill purposes:

In case you want to use an external power amplifier to drive your main speaker systems, the internal power amplifier can be used for monitoring or side-fill purposes. Use short patch-cables to connect the AUX3 OUTPUT with the EQ INPUT L and the MONO OUTPUT with the EQ INPUT R. This enables you to use the internal graphic equalizer to separately adjust the signals of the monitor and the side-fill output channels. The volume of the main channels can still be controlled via the master faders. The monitor speakers' volume is determined by the setting of the AUX3 fader while the MONO-fader controls the volume of the side-fill channel.

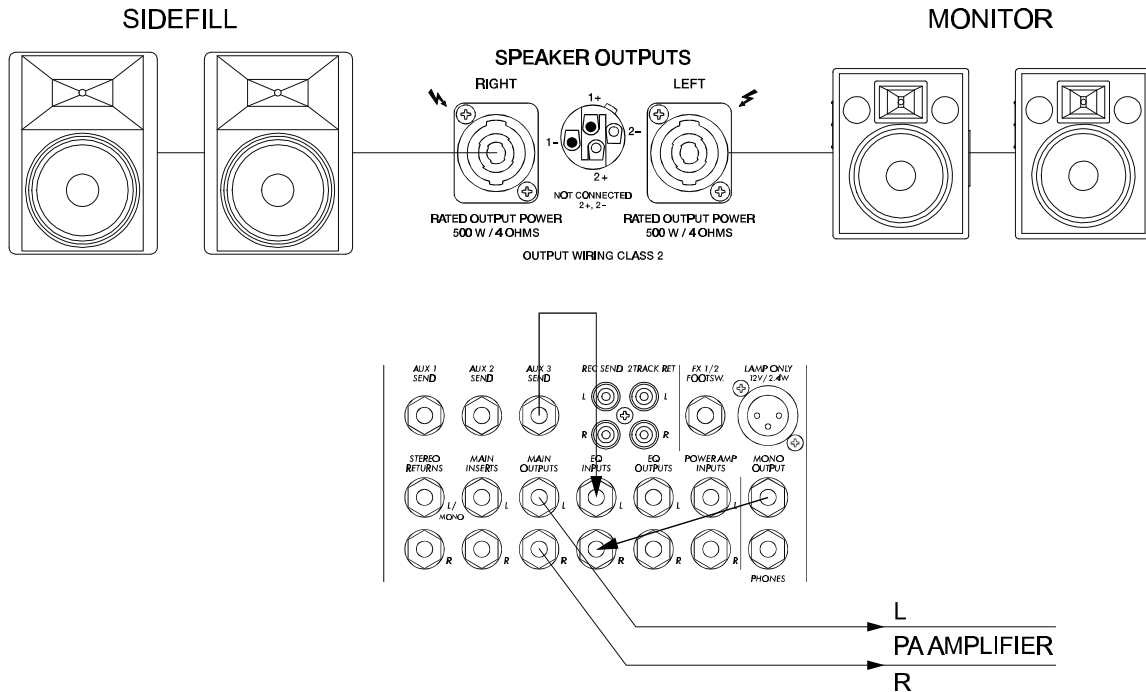

## 4. Monaural sound reinforcement with monitoring:

If your application does not demand stereo audio, you can operate the PSX in mono. In that case you can use short patch-cables to connect the MONO OUTPUT with the EQ INPUT R and the AUX3 OUTPUT with the EQ INPUT L. The right main output is used for the sound reinforcement while the left main output carries the monitor signal.

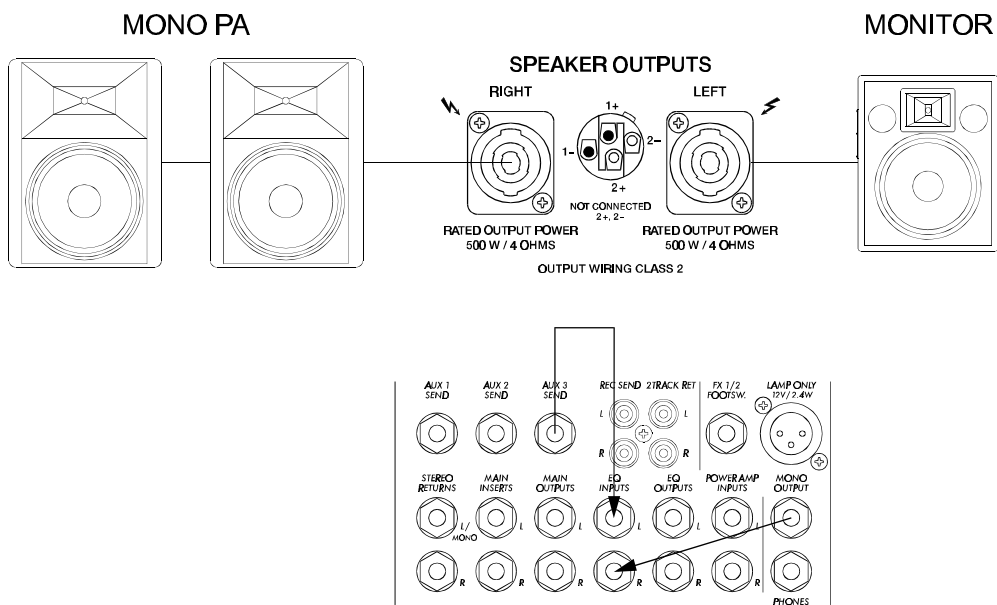



## 5. Maximum amount of speakers in a passive configuration:

The PSX allows connection of up to three loudspeaker cabinets with an impedance of 8 ohms per channel. In other words: the internal power amplifier is capable of driving a maximum of six 8 ohm speaker models. The following diagram shows how the speakers have to be connected.

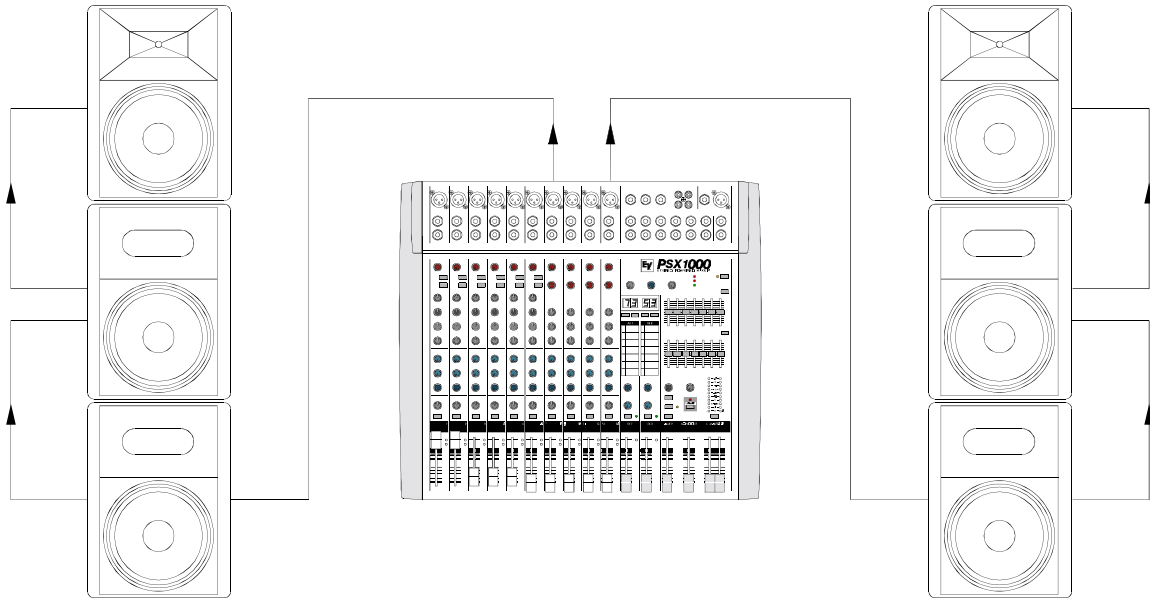

## 6. Active stereo 2-way configuration:

In this example the internal power amplifier of the PSX is used to drive the Hi/Mid cabinets. An active cross-over is connected to the MAIN OUTPUTS or the EQ OUTPUTS which carry the full-range signals. The LF-signal outputs of the crossover are connected to an external power amplifier, driving the woofer cabinets. The signal of the crossover's HF-signal outputs is fed into the PSX's internal power amplifier via the POWER AMP INPUTS. Compared to the passive configuration, the overall sound gains clarity and higher volume levels are possible, since the Hi/Mid cabinets do not have to deal with the low frequency signals.

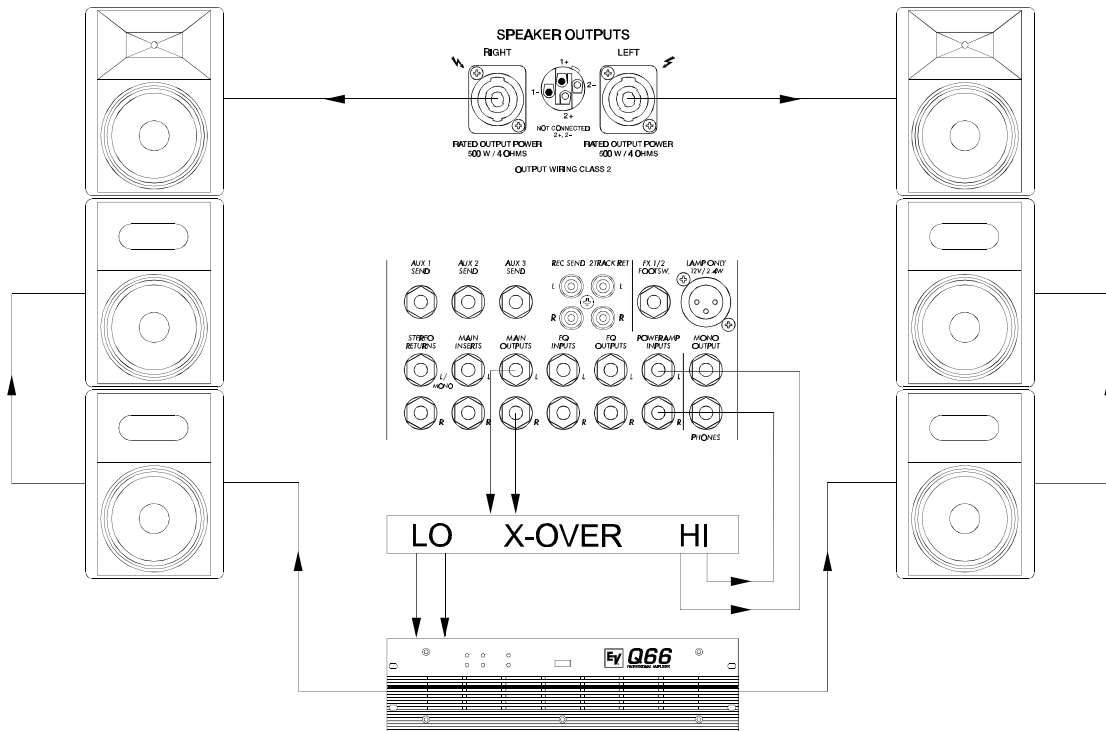

## SPECIFICATIONS

**Technical Specifications PSX** Mixing desk in rated condition, Unity Gain ( MIC Gain 20 dB ), all faders position 0 dB, all pots in mid position, Master fader + 6dB, amplifier rated output power into 8 ohms, one channel driven, unless otherwise specified.

	<b>PSX1000</b>	<b>PSX1600</b>	<b>PSX2200</b>
<b>Maximum Midband Output Power</b> , 1 kHz, THD ≤ 1%			
into 4 ohms	2 x 570 W	2 x 570 W	2 x 760 W
into 8 ohms	2 x 340 W	2 x 340 W	2 x 430 W
<b>Rated Output Power</b> , 20 Hz ... 20 kHz, THD ≤ 0.2%			
into 4 ohms	2 x 500 W	2 x 500 W	2 x 700 W
into 8 ohms	2 x 250 W	2 x 250 W	2 x 350 W
<b>Maximum Output Voltage</b> of power amplifier, no load	58 Vrms	58 Vrms	63 Vrms
<b>THD</b> at 1kHz, MBW=80kHz			
MIC input to Main L/R output, +16 dBu	< 0.006%	< 0.006%	< 0.006%
Power amplifier input to Speaker L/R output	< 0.05%	< 0.05%	< 0.05%
<b>DIM 30</b> , power amplifier	< 0.015%	< 0.015%	< 0.015%
<b>IMD-SMPTE</b> , power amplifier, 60Hz, 7 kHz	< 0.15%	< 0.15%	< 0.15%
<b>Frequency Response</b> , -3dB ref. 1kHz			
Any input to any Mixer output	15Hz ... 60kHz	15Hz ... 60kHz	15Hz ... 60kHz
Any input to Speaker L/R output	30Hz ... 40kHz	30Hz ... 40kHz	30Hz ... 40kHz
<b>Crosstalk</b> , 1kHz			
Fader and AUX-Send attenuation	> 80 dB	> 80 dB	> 80 dB
Channel to channel	> 70 dB	> 70 dB	> 70 dB
<b>CMRR</b> , MIC input, 1kHz	> 80 dB	> 80 dB	> 80 dB
<b>Input Sensitivity</b> , all level controls in max. position			
MIC Input	-74 dBu (155 µV)	-74 dBu (155 µV)	-74 dBu (155 µV)
Line Input (Mono)	-54 dBu (1.55 mV)	-54 dBu (1.55 mV)	-54 dBu (1.55 mV)
Line Input (Stereo)	-34 dBu (15.5 mV)	-34 dBu (15.5 mV)	-34 dBu (15.5 mV)
Power Amplifier Input	+ 6 dBu (1.55 V)	+ 6 dBu (1.55 V)	+ 6 dBu (1.55 V)
<b>Maximum Level</b> , mixing desk			
MIC inputs	+ 11 dBu	+ 11 dBu	+ 11 dBu
Line inputs	+ 30 dBu	+ 30 dBu	+ 30 dBu
All other inputs	+ 20 dBu	+ 20 dBu	+ 20 dBu
Record Send output	+ 16 dBu	+ 16 dBu	+ 16 dBu
All other outputs	+ 20 dBu	+ 20 dBu	+ 20 dBu
<b>Input Impedances</b>			
MIC	1.8 kohms	1.8 kohms	1.8 kohms
Insert Return	2.2 kohms	2.2 kohms	2.2 kohms
EQ Input and 2 Track Return	8 kohms	8 kohms	8 kohms
All other inputs	> 15 kohms	> 15 kohms	> 15 kohms
<b>Output Impedances</b>			
Record Send	1 kohms	1 kohms	1 kohms
Phones	47 ohms	47 ohms	47 ohms
All other outputs	75 ohms	75 ohms	75 ohms
<b>Equivalent Input Noise</b> , MIC Input, A-weighted 150 ohms	-130 dBu	-130 dBu	-130 dBu
<b>Noise</b> , Channel inputs to Main L/R outputs, A-weighted			
Master fader down	-92 dBu	-92dBu	-92dBu
Master fader 0 dB, Channel fader down	-89 dBu	-87dBu	-85dBu
Master fader 0 dB, Channel fader 0 dB, Channel gain unity	-83 dBu	-81dBu	-79dBu
<b>Signal/Noise-Ratio</b> , power amplifier, A-weighted	104 dB	104 dB	106 dB
<b>Equalization</b>			
LO Shelving		± 15 dB / 60 Hz	
MID Peaking, mono inputs		± 15 dB / 100 Hz ... 8 kHz	
MID Peaking, stereo inputs		± 12 dB / 2.4 kHz	
HI Shelving		± 15 dB / 12 kHz	
Master EQ, 2x7-band		± 10 dB	
<b>Phantom Power</b>	24V DC	24V DC	24V DC
<b>Mains voltage</b>	120V AC/50-60Hz	120V AC/50-60Hz	120V AC/50-60Hz
<b>Power Consumption</b> at 1/8 maximum output power, 4 ohms	600 W	670W	1100W
<b>Dimensions</b> , (WxHxD), mm	508.5x210.3x478.7	667.5x210.3x478.7	826.5x210.3x478.7
<b>Weight</b> , including lid	20 kg	24kg	29kg
<b>Optional</b>			
Goosneck Lamp, 12V/2.4W, 12", XLR	112 700	112 700	112 700
Footswitch FS11	110 693	110 693	110 693
Rack-Mount-Kit(PSX1000) NRS 90220	112 698		

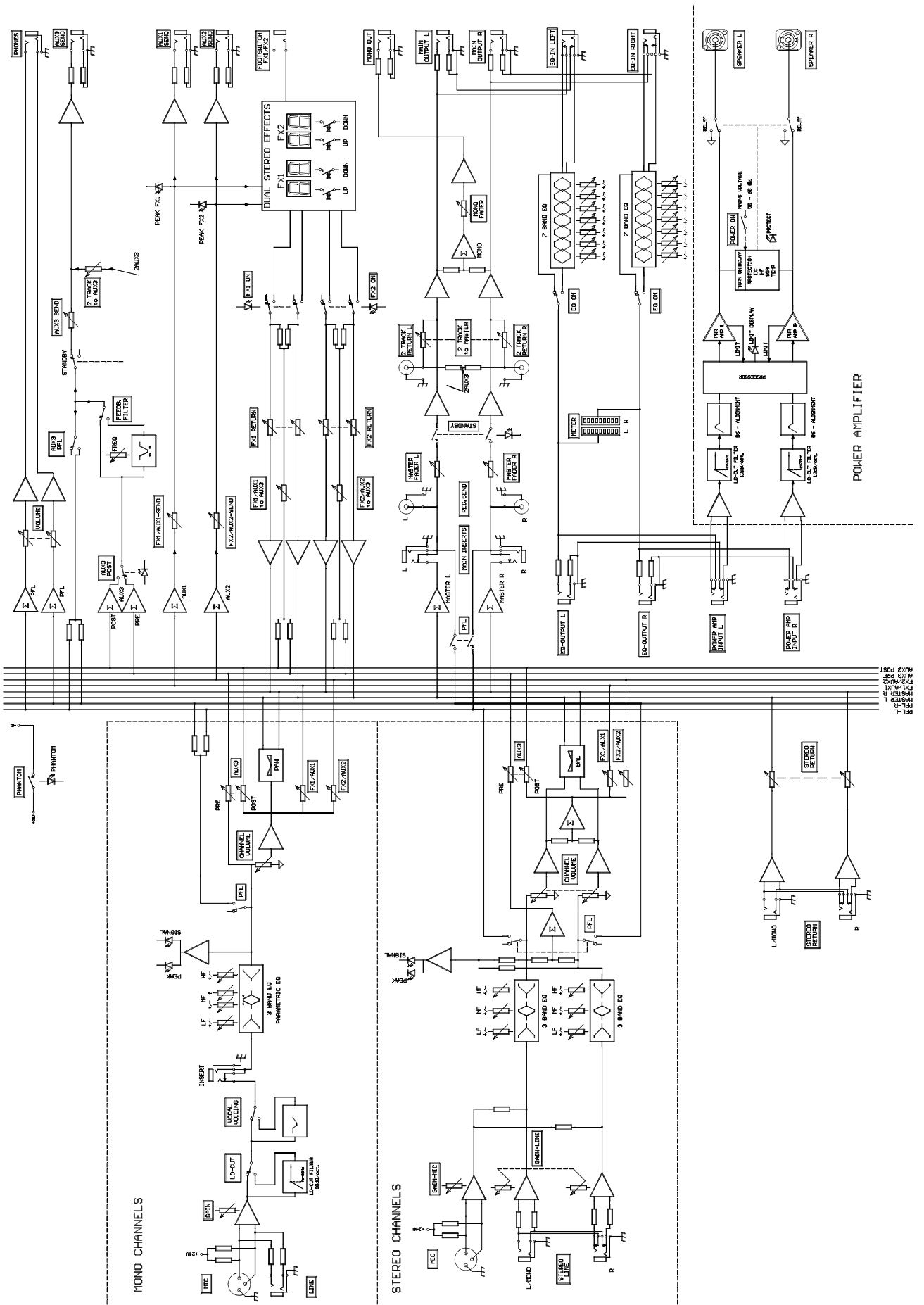

# DIMENSIONS

Dimensions in mm (inch)

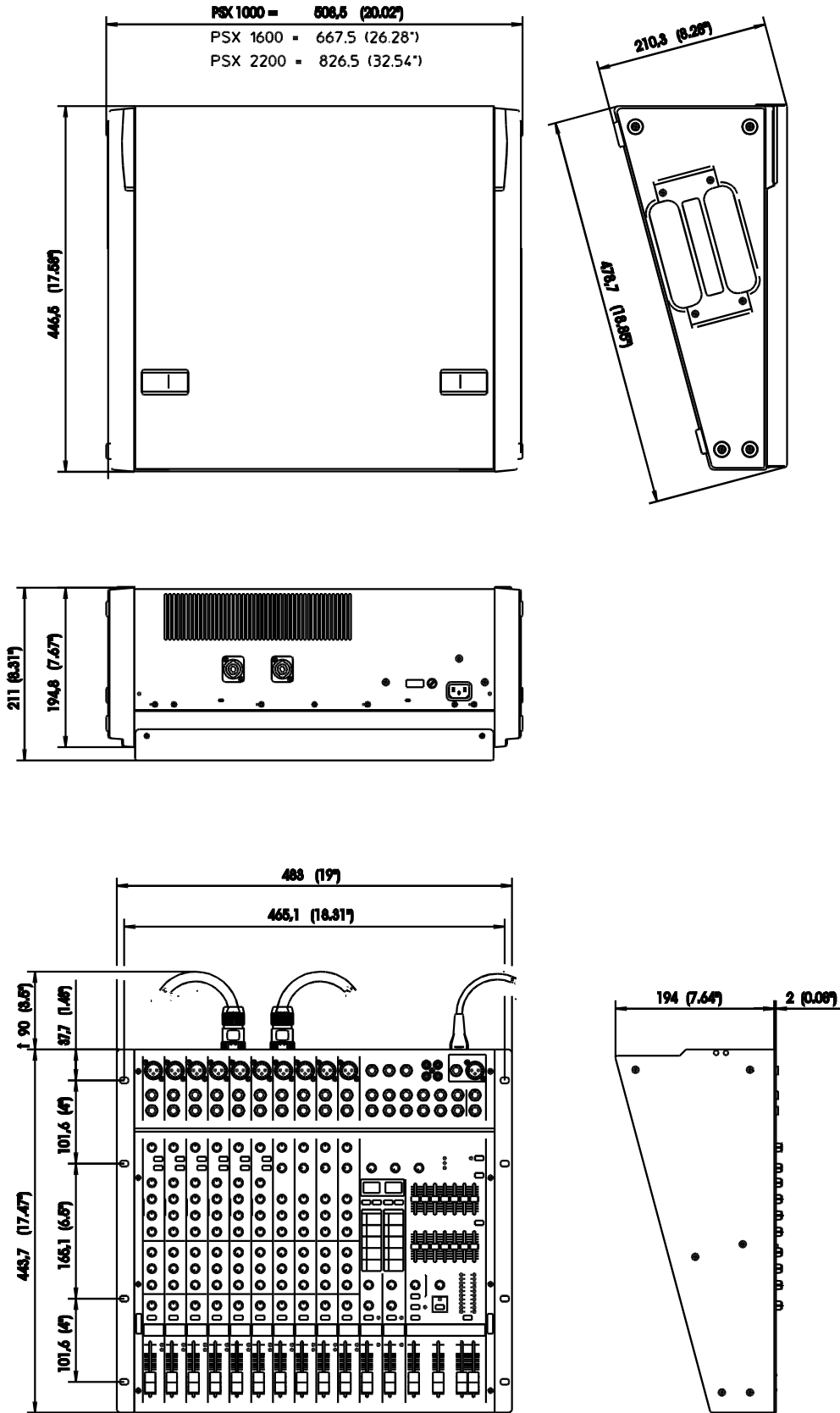

RACK MOUNTED

## WARRANTY (Limited)

Electro-Voice products are guaranteed against malfunction due to defects in materials or workmanship for a specified period, as noted in the individual product-line statement(s) below, or in the individual product data sheet or owner's manual, beginning with the date of original purchase. If such malfunction occurs during the specified period, the product will be repaired or replaced (at our option) without charge. The product will be returned to the customer prepaid.

**Exclusions and Limitations:** The Limited Warranty does not apply to: (a) exterior finish or appearance; (b) certain specific items described in the individual product-line statement(s) below, or in the individual product data sheet or owner's manual; (c) Malfunction resulting from use or operation of the product other than as specified in the product data sheet or owner's manual; (d): malfunction resulting from misuse or abuse of the product; or (e): malfunction occurring at any time after repairs have been made to the product by anyone other than Electro-Voice or any of its authorized service representatives.

**Obtaining Warranty Service:** To obtain warranty service, a customer must deliver the product, prepaid, to Electro-Voice or any of its authorized service representatives together with proof of purchase of the product in the form of a bill of sale or receipted invoice. A list of authorized service representatives is available from Electro-Voice at 600 Cecil Street, Buchanan, MI 49107 (616-695-6831) and/or Electro-Voice West at 9130 Glenoaks Boulevard, Sun Valley, CA 91532 (213-875-1900).

**Incidental and Consequential Damages Excluded:** Product repair or replacement and return to the customer are the only remedies provided to the customer. Electro-Voice shall not be liable for any incidental or consequential damages including, without limitation, injury to persons or property or loss of use. Some states do not allow the exclusion or limitation of incidental or consequential damages so the above limitation or exclusion may not apply to you. **Other Rights:** This warranty gives you specific legal rights, and you may have other rights which vary from state to state.

**Electro-Voice Electronics** are guaranteed against malfunction due to defects in materials or workmanship for a period of three (3) years from the date of original purchase. Additional details are included in the Uniform Limited Warranty Statement.

Specifications subject to change without notice.



**Electro-Voice®**

600 Cecil Street, Buchanan, Michigan 49107, Phone 616/695-6831, Fax: 616/695-1304

TELEX/EVI Audio Canada, 705 Progress Ave. Unit 46 Toronto, Ontario, M1H 2x1, Canada, Phone: 800/881-1685, Fax: 877/522-2242

TELEX Communications A.G., Kellenstrasse 11, CH-2563 IPSACH, Switzerland, Phone: 011-41/32-51-6833, Fax: 011-41/32-51-1221

EVI Audio Deutschland GmbH, Hirschberger Ring 45, D-94315, Straubing, Germany, Phone: 011-49/9421-7060, Fax: 011-49/9421-706265

EVI Audio France S.A., Parc de Courcerin-Allee Lech Walesa, Lognes, f-77185 Marne La Vallee, France, Phone: 011-33/1-6480-0090, Fax: 011-33/1-6006-5103

EVI Audio Japan Ltd., 2-5-60 Izumi, Suginami-ku, Tokyo, Japan 168, Phone: 011-81/3-3325-7900, Fax: 011-81/3-3325-7789

EVI Audio (Aust.) Pty., Unit 23, Block C, Slough Business Park, Slough Ave., Silverwater, N.S.W 2141, Australia, Phone 011-61/2-648-3455, Fax: 011-61/2-648-5585

EVI Audio (Hong Kong) Limited, Unit E & F, 21 /F., Luk Hop Industrial Bldg., 8 Luk Hop St., San Po Kong, Kowloon, Hong

(358 173) 18.01.2000

## Free Manuals Download Website

<http://myh66.com>

<http://usermanuals.us>

<http://www.somanuals.com>

<http://www.4manuals.cc>

<http://www.manual-lib.com>

<http://www.404manual.com>

<http://www.luxmanual.com>

<http://aubethermostatmanual.com>

Golf course search by state

<http://golfingnear.com>

Email search by domain

<http://emailbydomain.com>

Auto manuals search

<http://auto.somanuals.com>

TV manuals search

<http://tv.somanuals.com>