

LEYTON®

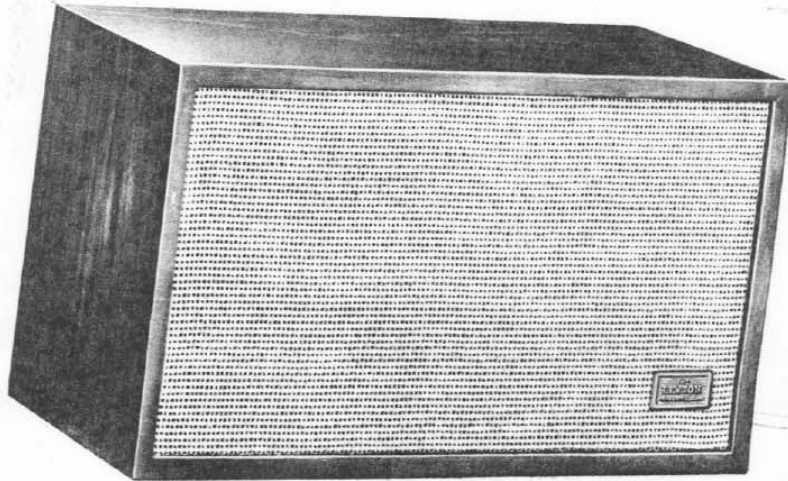

Electro-Voice®

LOW RESONANCE
LOUDSPEAKER SYSTEM
ULTRA COMPACT



- SPECIFICATIONS
- INSTRUCTIONS
- APPLICATIONS



Electro-Voice®

LEYTON

INTRODUCTION

The new Electro-Voice Leyton is a 2-way low-resonance system which, despite its ultra-compact design, provides exceptionally wide-range response. It contains a special 12" woofer, the Electro-Voice 12BWS, and an 8" extended-range cone-type speaker. These features make it an excellent choice for either monaural or stereo reproduction.

Constructed of fine hardwood veneers, the Leyton is finished on four sides to allow use in either vertical or horizontal position. The nameplate may be rotated for vertical placement. The use of heavy, vibration-free 3/4" panels gives the Leyton unusual rigidity.

SPECIFICATIONS

Nominal Impedance: 8 ohms

Power Handling Capacity:

Sine Wave: 40-13,000 cps., 20W.

Program: Maximum undistorted output of 70 watt amplifier on complex program signal.

Frequency Response Range:

40-13,000 cps.

Components:

12BWS woofer, 8" extended range speaker, crossover network, and level control.

Size:

12" D., 14" H., 25" W.

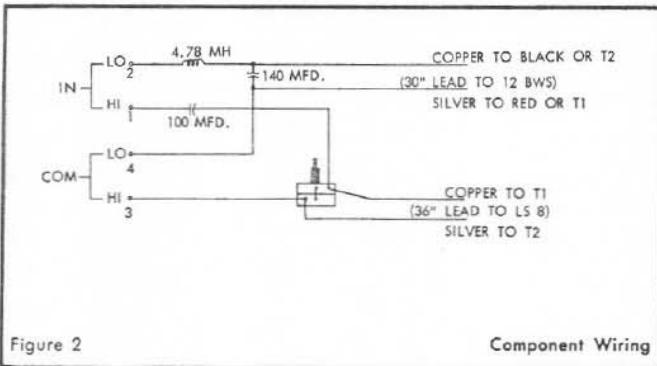

Figure 2

Component Wiring

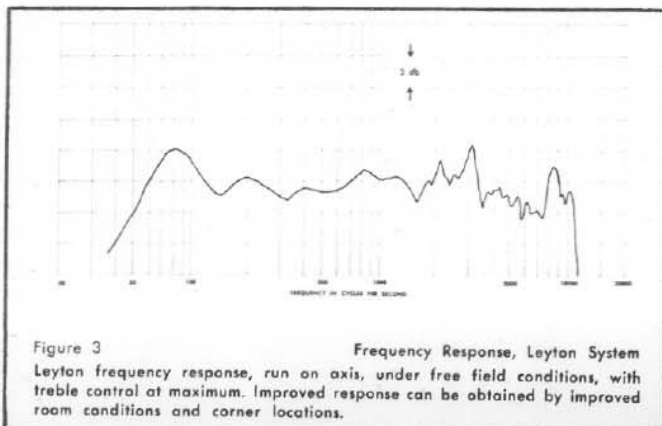

Figure 3

Frequency Response, Leyton System

Leyton frequency response, run on axis, under free field conditions, with treble control at maximum. Improved response can be obtained by improved room conditions and corner locations.

Setting Up For Operation

Shipping Damage: Your Leyton is packed in accordance with all shipping requirements of the Interstate Commerce Commission, plus extra protection. If shipping damage occurs, contact the carrier directly, requesting inspection and instructions. Use the date code of the speaker in your correspondence.

Date Code Number: The date code is noted on your warranty registration card. The number indicates type, style, and date of manufacture of the unit. Always use this number in your correspondence.

Warranty Card: To register your Leyton, fill out the Warranty Registration Card and send it to the factory within ten days after your purchase.

Placement

Nearly any speaker system will sound best if it is placed in or near the corner of the room in which it is to be used. This positioning provides the best coupling between the speakers and the air in the room, the corners and walls acting as a large "horn" for the sound. The small size of the Leyton also makes it ideal for bookshelf placement. Best height is at the listeners ear level. Four small self-adhesive felt pads are provided to protect the bottom face of the cabinet.

Connections

Connection of your Leyton to the amplifier should be made with No. 18 or larger wire (Common lamp cord is good). If you wish to run the lead behind a moulding strip or under a carpet, use 300-ohm TV twin lead. Connect to the 8-ohm and common taps on the back of the amplifier. If the amplifier has a variable dampening control, it should be set at 1. Be certain that these connections are secure. Jumpers should be left in place unless unit is used for stereo reproduction with E-V STEREO 100 "add-on" unit. Specific instructions will be found with the STEREO 100.

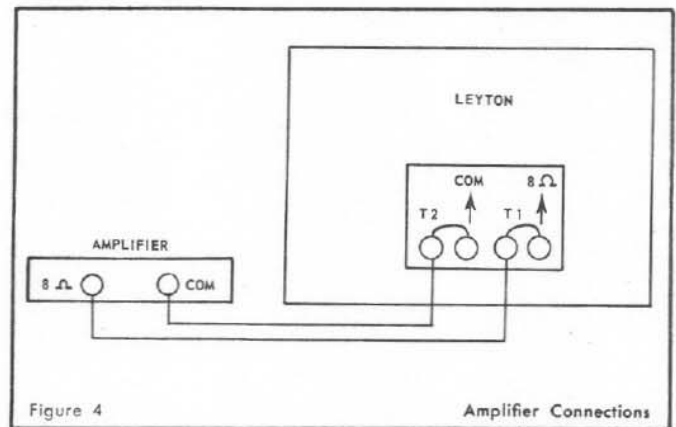

Figure 4

Amplifier Connections

Level Controls

Your Leyton is equipped with a treble array adjustment at the rear. Set this control fully clockwise unless the Leyton is to be matched in a stereo arrangement with a speaker of differing efficiency. (If used with STEREO 100's in 3 channel stereo, full instructions for setting will be found on the STEREO 100 instruction sheet).

No brilliance control is provided in the Leyton system.

Stereo Operation

Your Leyton is designed for professional quality sound reproduction. The same performance features which make this unit outstanding for monaural reproduction will also give superb performance in stereophonic array.

The wiring connections for a pair of Leytons in stereo are shown in Fig. 5. When connecting be sure to run the lead from T1 on the Leyton to the 8-ohm terminal on the amplifier and from T2 to the COMMON terminal. With this connection both units will then be phased correctly.

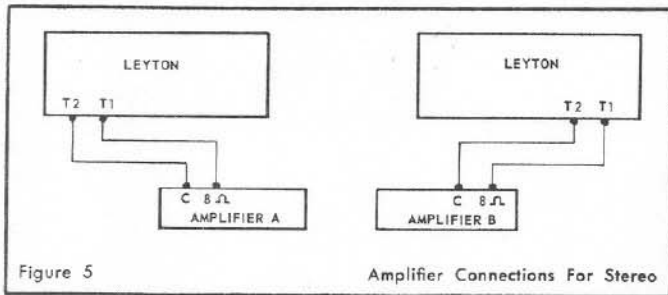

Placement For Stereo

When arranging a pair of Leytons in stereo array, the units should be placed at positions which allow the listener to sit at the apex of a 30° to 40° angle, as shown in Fig. 6. This will provide the best stereophonic effect. If this placement is not possible, you may, by experiment, use room reverberations to advantage in finding other desirable positions.

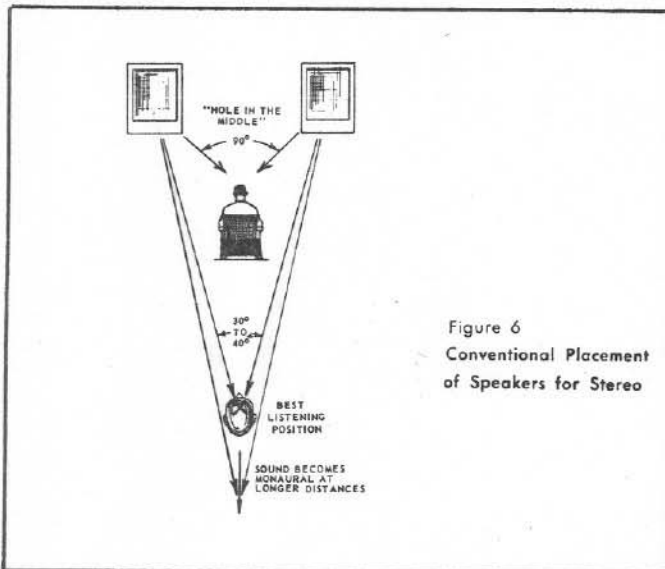

Widening The Stereo Area — 3-Channel Listening

The natural extension of 2-channel stereo reproduction is to recreate completely the original performance, suitably tailored to suit the individual taste and listening area.

In stereo recording, great pains are taken to capture full realism by using 3 microphones to insure complete coverage of the sound stage. The sound from the microphone in the center is then "mixed out" to both left and right channels of recorded sound. From this master recording emerges the commercially available 2-channel stereo tape or disc.

In these "two track" stereo tapes and discs the element of this third channel remains and can be reformed by means of the Electro-Voice XT-1 Stereo Mixer Transformer and a third speaker system. XT-1 recovers the center sound from the left and right channels, adds them together in the correct proportions, and passes them to the central speaker.

The addition of this third channel to your system gives complete flexibility of seating, in that one can now enjoy good stereo anywhere in a very large room, or more importantly, quite close to the loudspeakers in small rooms. At all times, in virtually any listening position there is a complete curtain of stereo sound.

Stereons

For those who have space or budget limitations, a Stereon 100 (see next page) can be used with the Leyton for either two- or three-channel stereo. The Stereon 100, which matches exactly the treble array of the Leyton, can be used virtually without compromise in sound by taking advantage of a natural phenomenon: in 1934, an acoustic engineer, Harvey Fletcher, determined that sounds from about 300 cycles per second downwards in the audio spectrum (which have a wavelength greater than 3½ feet) are not intercepted to any perceptible degree by the head; accordingly, the ears find it impossible to detect the direction from which such sounds originate. E-V Stereons take advantage of this phenomenon by using the full bass reproduction capabilities of one full-range reproducing system for all bass and channelling the "stereo" sounds (above 200 cps.) correctly to each channel. The Stereons, then, permit easy and economical expansion to the stereo system.

The popular approach to E-V Panasonnd (3-channel stereo sound) is obtained by using two Leytons with one Stereon 100. This arrangement permits the use of two full-range units, to achieve the fullest bass response. Where space is an intense problem, good performance can also be achieved by using a pair of Stereon 100's with one Leyton.

Complete wiring diagrams for connecting the Leyton with Stereons and XT-1 will be found in the instruction sheets accompanying the Stereon.

Speaker Repairs

Your Leyton system is guaranteed indefinitely against defects in workmanship and materials. Should Leyton become damaged or develop faulty operation from unusual conditions of employment, Electro-Voice maintains a complete service department to put equipment in factory-new condition. If it becomes necessary to return the equipment for repair, please write for authorization and shipping instructions.

Technical Service

The distributor from whom you purchased your equipment knows thoroughly the application of Electro-Voice products and high-fidelity techniques. His advice on the installation of Electro-Voice components and on the selection of associated high-fidelity equipment will be invaluable. Technical problems which cannot be answered locally may be referred to:

MANAGER, CONSUMER PRODUCTS DIVISION
Electro-Voice, Inc.
Buchanan, Michigan

When writing, please list the manufacturer and model number of all components used in your high-fidelity system.

HIGH FIDELITY ACCESSORIES SUGGESTED FOR USE WITH THE LEYTON

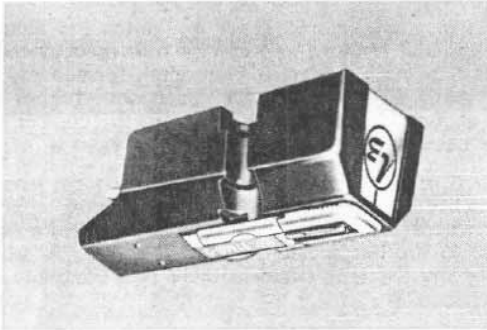

For more than 35 years, Electro-Voice has been a leader in the development and manufacture of dynamic microphones and loudspeakers. Why then, with this extensive experience in designing and producing electro-magnetic devices, is Electro-Voice introducing the new Magneramic 31 Series stereo cartridge using ceramic elements?

The reason is that Electro-Voice is genuinely convinced that a precision ceramic cartridge is the finest type that can be made today . . . definitely superior to the magnetic type. The superiority of the Magneramic 31 is demonstrated in these three areas:

(1) *Greater Flexibility* — The 31 Series cartridge will operate perfectly at any stylus pressure from 2 to 20 grams. The same stylus assembly can be used for operation of both turntable and record changers; performance need not be compromised by using a special, stiff stylus assembly for record changers. Record wear is the only criterion in setting stylus pressure — cartridge operation is not affected. Thus, when converting from a changer to a turntable, or vice versa, replacement of the stylus assembly is not necessary when using the Magneramic 31.

(2) *Higher Output* — Along with the trend toward less efficient speaker systems, more amplifier power has become a necessity. While most stereo amplifiers are now designed with input sensitivities to match the typical 5 millivolt output of magnetic stereo cartridges, nearly all monaural amplifiers were designed for at least 8 millivolt input. These cannot be driven to full output with a magnetic stereo cartridge.

The Magneramic 31 develops a full 8 millivolt output and couples directly into any magnetic preamp unit. This higher output should be given special consideration by those planning to convert to stereo with existent monaural amplifiers.

(3) *Freedom from Hum* — The increased amplifier gain required to drive low efficiency speakers coupled with decreased cartridge output has significantly increased system hum problems. Also, conventional methods of hum elimination used in monaural magnetic cartridges become difficult or impossible to apply to stereo magnetics. The Magneramic 31 completely eliminates these problems. It is non-inductive and has adequate output.

The Electro-Voice Magneramic 31MD7 cartridge directly replaces any monophonic or stereophonic magnetic cartridge now on the market. It feeds into the preamp input jack specified for magnetic cartridges and does not require adapter or circuit modifications.

SPECIFICATIONS — MAGNERAMIC 31MD7

<i>Response Range:</i>	20 to 15000 cps. + 2 db (Westrex 1A)	<i>Output:</i>	8 millivolts
<i>Compliance, Vertical:</i>	3.5 x 10 ⁶ cm/dyne	<i>Recommended Load:</i>	22,000 to 47,000 ohms (Magnetic phono inputs)
<i>Compliance, Lateral:</i>	3.5 x 10 ⁶ cm/dyne	<i>Elements:</i>	2, lead Zirconium Titanate (Ceramic)
<i>Isolation:</i>	28 db @ 1000 cycles	<i>Weight:</i>	8 grams
<i>Tracking Force:</i>	2 to 4 grams in transcription arms 4 to 6 grams in changer arms	<i>Terminals:</i>	4, standard .050" connectors
<i>Styli:</i>	.7 mil diamond	<i>Mounting Centers:</i>	Fits both 1/2" and 7/16"

Audiophile Net \$24.00

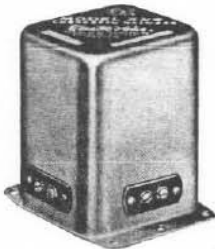

Model XT-1 Stereo Mixer Transformer

For use with the Stereon 100 and Leyton. Only one required for two- or three-channel stereo system.

Audiophile Net \$13.50

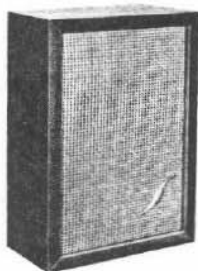

Stereon 100

The Stereon 100—An add-on speaker system designed expressly to complement furniture styling and acoustical performance of the LEYTON. Functions on proven principle that bass tones (below 300 cps) contribute nothing to the stereophonic effect. Unit reproduces only sounds above 200 cps giving maximum safety margin in this region. Ideal as center channel unit or in pairs with Leyton in center. Must be used with XT1 Stereo Mixer Transformer. Finished hardwood hand-rubbed veneers, walnut, mahogany or in Unfinished Birch.

Complete with full instructions.

Audiophile Net \$49.50

(Prices above are subject to change without notice.)

Electro-Voice®

LEYTON

INTRODUCTION

The new Electro-Voice Leyton is a 2-way low-resonance system which, despite its ultra-compact design, provides exceptionally wide-range response. It contains a special 12" woofer, the Electro-Voice 12BWS, and an 8" extended-range cone-type speaker. These features make it an excellent choice for either monaural or stereo reproduction.

Constructed of fine hardwood veneers, the Leyton is finished on four sides to allow use in either vertical or horizontal position. The nameplate may be rotated for vertical placement. The use of heavy, vibration-free $\frac{3}{4}$ " panels gives the Leyton unusual rigidity.

SPECIFICATIONS

Nominal Impedance: 8 ohms

Power Handling Capacity:

Sine Wave: 40-13,000 cps., 20W.

Program: Maximum undistorted output of 70 watt amplifier on complex program signal.

Frequency Response Range: 40-13,000 cps.

Components: 12BWS woofer, 8" extended range speaker, crossover network, and level control.

Size: 12" D., 14" H., 25" W.

Setting Up For Operation

Shipping Damage: Your Leyton is packed in accordance with all shipping requirements of the Interstate Commerce Commission, plus extra protection. If shipping damage occurs, contact the carrier directly, requesting inspection and instructions. Use the date code of the speaker in your correspondence.

Date Code Number: The date code is noted on your warranty registration card. The number indicates type, style, and date of manufacture of the unit. Always use this number in your correspondence.

Warranty Card: To register your Leyton, fill out the Warranty Registration Card and send it to the factory within ten days after your purchase.

Placement

Nearly any speaker system will sound best if it is placed in or near the corner of the room in which it is to be used. This positioning provides the best coupling between the speakers and the air in the room, the corners and walls acting as a large "horn" for the sound. The small size of the Leyton also makes it ideal for bookshelf placement. Best height is at the listeners ear level. Four small self-adhesive felt pads are provided to protect the bottom face of the cabinet.

Connections

Connection of your Leyton to the amplifier should be made with No. 18 or larger wire (Common lamp cord is good). If you wish to run the lead behind a moulding strip or under a carpet, use 300-ohm TV twin lead. Connect to the 8-ohm and common taps on the back of the amplifier. If the amplifier has a variable dampening control, it should be set at 1. Be certain that these connections are secure. Jumpers should be left in place unless unit is used for stereo reproduction with E-V STEREO 100 "add-on" unit. Specific instructions will be found with the STEREO 100.

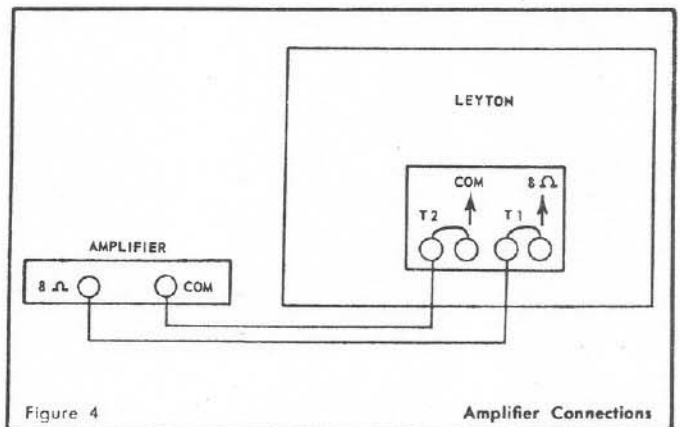
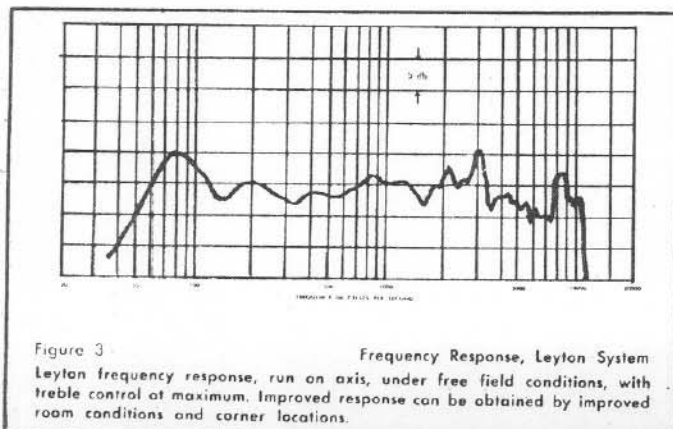
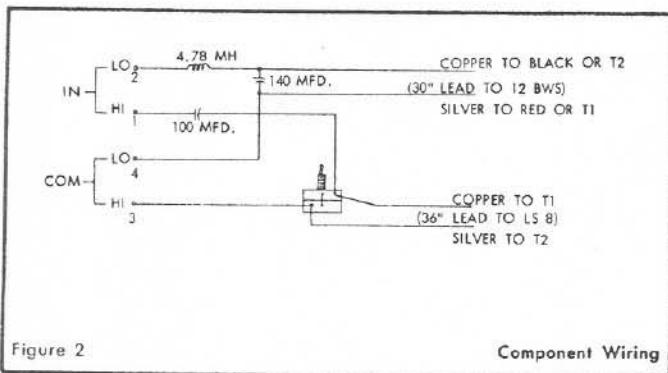

Level Controls

Your Leyton is equipped with a treble array adjustment at the rear. Set this control fully clockwise unless the Leyton is to be matched in a stereo arrangement with a speaker of differing efficiency. (If used with STEREO 100's in 3 channel stereo, full instructions for setting will be found on the STEREO 100 instruction sheet).

No brilliance control is provided in the Leyton system.

Stereo Operation

Your Leyton is designed for professional quality sound reproduction. The same performance features which make this unit outstanding for monaural reproduction will also give superb performance in stereophonic array.

The wiring connections for a pair of Leytons in stereo are shown in Fig. 5. When connecting be sure to run the lead from T1 on the Leyton to the 8-ohm terminal on the amplifier and from T2 to the COMMON terminal. With this connection both units will then be phased correctly.

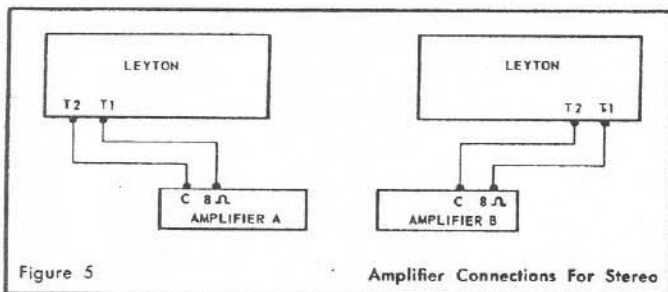

Figure 5

Amplifier Connections For Stereo

Placement For Stereo

When arranging a pair of Leytons in stereo array, the units should be placed at positions which allow the listener to sit at the apex of a 30° to 40° angle, as shown in Fig. 6. This will provide the best stereophonic effect. If this placement is not possible, you may, by experiment, use room reverberations to advantage in finding other desirable positions.

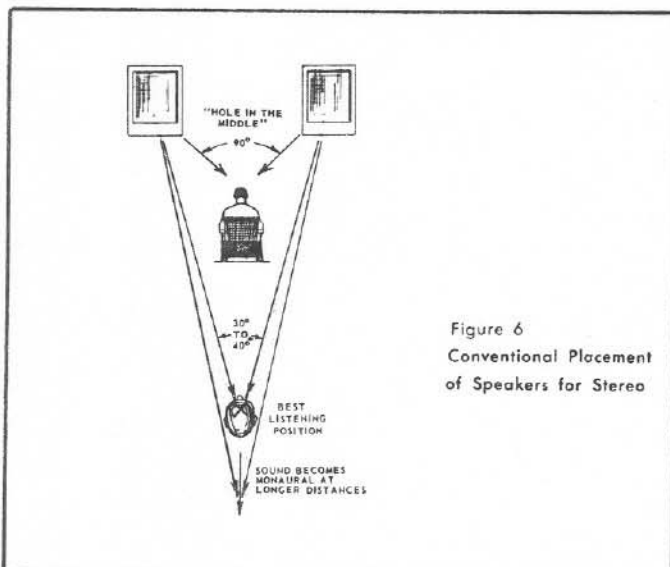

Figure 6
Conventional Placement
of Speakers for Stereo

Widening The Stereo Area — 3-Channel Listening

The natural extension of 2-channel stereo reproduction is to recreate completely the original performance, suitably tailored to suit the individual taste and listening area.

In stereo recording, great pains are taken to capture full realism by using 3 microphones to insure complete coverage of the sound stage. The sound from the microphone in the center is then "mixed out" to both left and right channels of recorded sound. From this master recording emerges the commercially available 2-channel stereo tape or disc.

In these "two track" stereo tapes and discs the element of this third channel remains and can be reformed by means of the Electro-Voice XT-1 Stereo Mixer Transformer and a third speaker system. XT-1 recovers the center sound from the left and right channels, adds them together in the correct proportions, and passes them to the central speaker.

The addition of this third channel to your system gives complete flexibility of seating, in that one can now enjoy good stereo anywhere in a very large room, or more importantly, quite close to the loudspeakers in small rooms. At all times, in virtually any listening position there is a complete curtain of stereo sound.

Stereons

For those who have space or budget limitations, a Stereon 100 (see next page) can be used with the Leyton for either two- or three-channel stereo. The Stereon 100, which matches exactly the treble array of the Leyton, can be used virtually without compromise in sound by taking advantage of a natural phenomenon: in 1934, an acoustic engineer, Harvey Fletcher, determined that sounds from about 300 cycles per second downwards in the audio spectrum (which have a wavelength greater than 3½ feet) are not intercepted to any perceptible degree by the head; accordingly, the ears find it impossible to detect the direction from which such sounds originate. E-V Stereons take advantage of this phenomenon by using the full bass reproduction capabilities of one full-range reproducing system for all bass and channelling the "stereo" sounds (above 200 cps.) correctly to each channel. The Stereons, then, permit easy and economical expansion to the stereo system:

The popular approach to E-V Panasound (3-channel stereo sound) is obtained by using two Leytons with one Stereon 100. This arrangement permits the use of two full-range units, to achieve the fullest bass response. Where space is an intense problem, good performance can also be achieved by using a pair of Stereon 100's with one Leyton.

Complete wiring diagrams for connecting the Leyton with Stereons and XT-1 will be found in the instruction sheets accompanying the Stereon.

Speaker Repairs

Your Leyton system is guaranteed indefinitely against defects in workmanship and materials. Should Leyton become damaged or develop faulty operation from unusual conditions of employment, Electro-Voice maintains a complete service department to put equipment in factory-new condition. If it becomes necessary to return the equipment for repair, please write for authorization and shipping instructions.

Technical Service

The distributor from whom you purchased your equipment knows thoroughly the application of Electro-Voice products and high-fidelity techniques. His advice on the installation of Electro-Voice components and on the selection of associated high-fidelity equipment will be invaluable. Technical problems which cannot be answered locally may be referred to:

MANAGER, CONSUMER PRODUCTS DIVISION
Electro-Voice, Inc.
Buchanan, Michigan

When writing, please list the manufacturer and model number of all components used in your high-fidelity system.

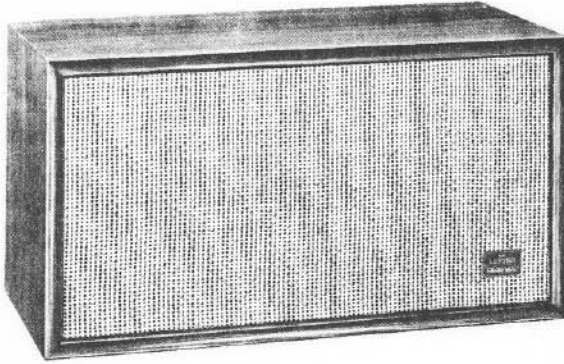

FEATURES

- TRUE TWO-WAY SYSTEM with electrical crossover
- ULTRA-COMPACT
- HIGH EFFICIENCY
- FINISHED ON FOUR SIDES for vertical or horizontal placement

The new Electro-Voice Leyton 100 is a two-way low-resonance system which, despite its ultra-compact design, provides exceptionally wide-range response. It contains a special 10" woofer, and a 5" extended-range cone-type speaker. These specialized components make it an excellent choice for either monaural or stereo reproduction.

Constructed of fine hardwood veneers, the Leyton 100 is finished on four sides to allow use in either vertical or horizontal position. The nameplate may be rotated for vertical placement. The use of heavy, vibration-free 3/4" panels gives the Leyton 100 unusual rigidity.

SPECIFICATIONS

Nominal Impedance: 8 ohms
 Power Handling Capacity: 30 watts program
 Frequency Response: 50-15,000 cps
 Components: 10" woofer, 5" extended range speaker, crossover network, and level control.
 Size: 12"D., 14"H., 25" W.

PLACEMENT

Nearly any speaker system will sound best if it is placed in or near the corner of the room in which it is to be used. This positioning provides the best coupling between the speakers and the air in the room, the corners and walls acting as a large "horn" for the sound. The small size of the Leyton 100 also makes it ideal for bookshelf placement. Best height is at the listener's ear level. Four small self-adhesive felt pads are provided to protect the bottom face of the cabinet.

OPERATION

CONNECTIONS

Connection of your Leyton 100 to the amplifier should be made with No. 18 or larger wire (common lamp cord is good). If you wish to run the lead behind a moulding strip or under a carpet, use 300-ohm TV twin lead. Connect to the 8-ohm and common taps on the back of the amplifier. If the amplifier has a variable damping control, it should be set at 1. Be certain that these connections are secure.

LEVEL CONTROL

Your Leyton 100 is equipped with a treble adjustment at the rear. Set this control at "Normal" setting indicated. This setting will be found to be the best possible adjustment for most rooms. Further adjustments may be made, however, to compensate for individual room characteristics or to match a speaker of differing efficiency in a stereo arrangement.

STEREO OPERATION

Your Leyton 100 is designed for professional quality sound reproduction. The same performance features which make this unit outstanding for monaural reproduction will also give superb performance in stereophonic array.

The wiring connections for a pair of Leyton 100's in stereo are shown in Fig. 1. When connecting be sure to run the lead from T1 on the Leyton 100 to the 8-ohm terminal on the amplifier and from T2 to the COMMON terminal. With this connection both units will then be phased correctly.

PLACEMENT FOR STEREO

When arranging a pair of Leyton 100's in stereo array, the units should be placed at positions which allow the listener to sit at the apex of a 30° to 40° angle, as shown in Fig. 2. This will provide the best stereophonic effect. If this placement is not possible, you may, by experiment, use room reverberations to advantage in finding other desirable positions.

SPEAKER REPAIRS

Your Leyton 100 system is guaranteed indefinitely against defects in workmanship and materials. Should your Leyton 100 become damaged or develop faulty operation from unusual conditions of employment, Electro-Voice maintains a complete service department to put equipment in factory-new condition. If it becomes necessary to return the equipment for repair, please write for authorization and shipping instructions.

TECHNICAL SERVICE

The distributor from whom you purchased your equipment knows thoroughly the application of Electro-Voice products and high-fidelity techniques. His advice on the installation of Electro-Voice components and on the selection of associated high-fidelity equipment will be invaluable. Technical problems which cannot be answered locally may be referred to:

Manager, Consumer Products Division
 Electro-Voice, Incorporated
 Buchanan, Michigan

When writing, please list the manufacturer and model number of all components used in your high-fidelity system.

SETTING UP FOR OPERATION

Shipping Damage: Your Leyton 100 is packed to meet or exceed all shipping requirements of the Interstate Commerce Commission. If shipping damage occurs, contact the carrier directly, requesting inspection and instructions. Use the date code of the speaker in your correspondence.

Date Code Number: The date code is noted on your warranty registration card. The number indicates type, style, and date of manufacture of the unit. Always use this number in your correspondence.

Warranty Card: To register your Leyton 100, fill out the Warranty Registration Card and send it to the factory within ten days after your purchase.

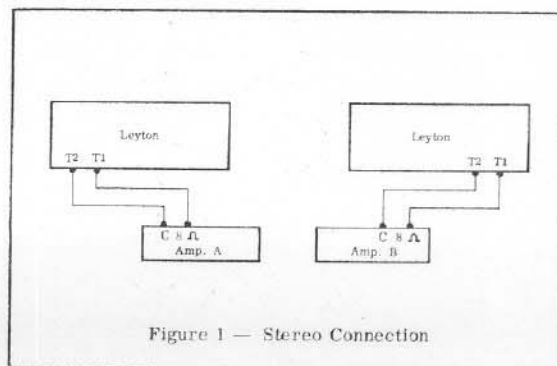

Figure 1 — Stereo Connection

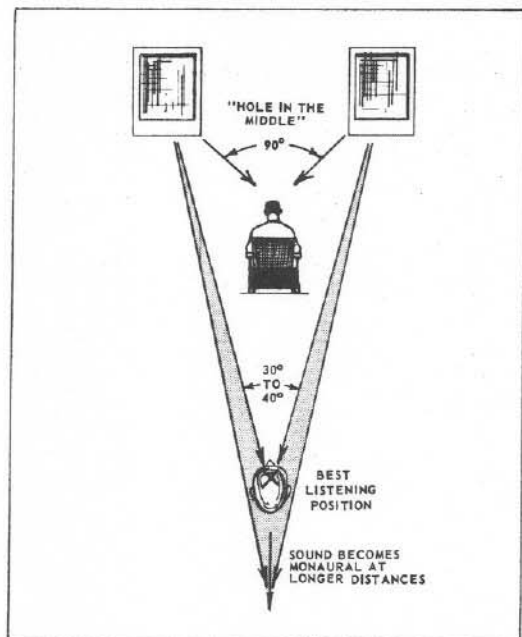

Figure 2 — Placement for Stereo

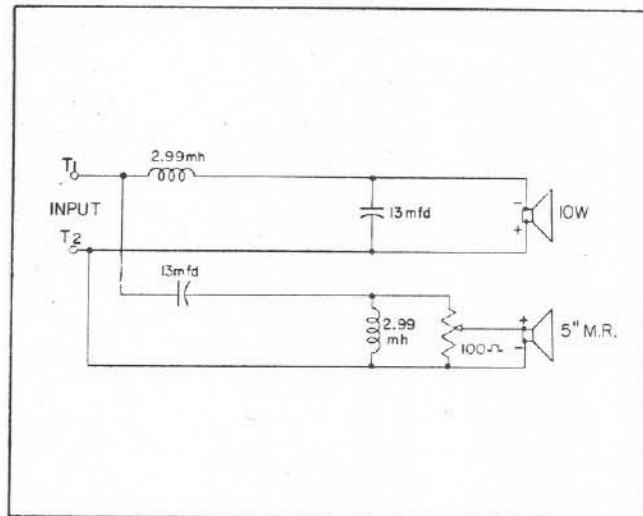

Figure 3 — Schematic

Free Manuals Download Website

<http://myh66.com>

<http://usermanuals.us>

<http://www.somanuals.com>

<http://www.4manuals.cc>

<http://www.manual-lib.com>

<http://www.404manual.com>

<http://www.luxmanual.com>

<http://aubethermostatmanual.com>

Golf course search by state

<http://golfingnear.com>

Email search by domain

<http://emailbydomain.com>

Auto manuals search

<http://auto.somanuals.com>

TV manuals search

<http://tv.somanuals.com>