

Electro-Voice®

a MARK IV company

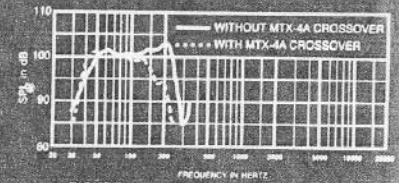

FIGURE 1 — MTL-4A Axial Frequency Response (1 watt/1 meter)

MTL-4A

Manifold Technology®

Low-Frequency

Sound Reinforcement

System

SPECIFICATIONS

Frequency Response, Measured in Farfield Calculated to One Meter on Axis, Swept One-Third-Octave Pink Noise, One-Watt Input, Anechoic Environment (see Figure 1):

40-225 Hz

Low-Frequency 3-dB-Down Point:

40 Hz

Usable Low-Frequency Limit (10-dB-down point):

32 Hz

Half-Space Reference Efficiency:

11.3%

Long-Term Average Power Handling Capacity per EIA Standard RS-426A (see Power Handling Capacity section):

1,600 watts

Short-Term Power Handling Capacity (10 milliseconds):

6,400 watts

Maximum Long-Term Average Midband Acoustic Output:

200 watts

Sound Pressure Level at 1 Meter, Indicated Input Power, Anechoic Environment, Band-Limited Pink-Noise Signal, 50-200 Hz,

1 Watt: 102 dB

1,600 Watts: 134 dB

6,400 Watts: 140 dB

Dispersion Angle Included by 6-dB-Down Points on Polar Responses, Indicated One-Third-Octave Bands of Pink Noise, 80-160 Hz Horizontal and Vertical (see Figure 4):

177°±37°

Directivity Factor R_s (Q), Median over 80-160-Hz Range

(see Figure 4):

2.84

Directivity Index D_i , Median over 80-160-Hz Range

(see Figure 5):

4.5 dB
Distortion, 0.1 Full Power Input (see Figure 6),

Second Harmonic,

50 Hz:

0.6%

100 Hz:

0.5%

Third Harmonic,

50 Hz:

0.6%

100 Hz:

0.2%

Distortion, Full Power Input (see Figure 7),

Second Harmonic,

50 Hz:

1.4%

100 Hz:

1.8%

Third Harmonic,

50 Hz:

2.0%

100 Hz:

0.8%

Transducer Complement:

Four DL18MT

Box Tuning Frequency:

37 Hz

Impedance,

Nominal:

Two 4-ohm loads

Minimum:

Two 4-ohm loads

Input Connections:
Neutrik Speakon™ NL4MPR

Enclosure Materials,

Structural, All Versions:

14-ply birch plywood

Finish,

MTL-4AC, MTL-4APF:

Black Ozite Super TNT carpet

MTL-4AP, MTL-4APF:

Black textured paint

Hanging (MTL-4ACF and MTL-4APF only):

Two-point flying system (tracks accept Kinedyne 32102-1 and 32111-1 fittings)

Dimensions,

Height:

91.4 cm (36.0 in.)

Width:

91.4 cm (36.0 in.)

Depth:

76.2 cm (29.9 in.)

Net Weight:

119 kg (263 lb)

Shipping Weight:

140 kg (311 lb)

DESCRIPTION

The Electro-Voice MTL-4A Manifold Technology® low-frequency loudspeaker system was designed for high-level concert sound reinforcement in touring sound and permanent installation applications. The combination of the MTL-4A low-frequency loudspeaker system and the MTH-4A mid-bass/midrange/high-frequency loudspeaker system form the four-way active MT-4A concert-sound loudspeaker system. Optimum performance of the MT-4A system is obtained when used with the dedicated MTX-4A electronic crossover/equalizer/time-delay unit. There are four models in the MTL-4A series: the MTL-4AC (carpeted finish), the MTL-4ACF (carpeted finish with flying hardware), the MTL-4AP (painted finish) and the MTL-4APF (painted finish with flying hardware).

The MTL-4A is a vented-box design comprised of four DL18MT woofers, each facing into a manifold chamber at the center of the cabinet. This manifolding technique (U.S. Patent No. 4,733,249) results in increased acoustic loading, yielding increased low-frequency efficiency and reduced distortion

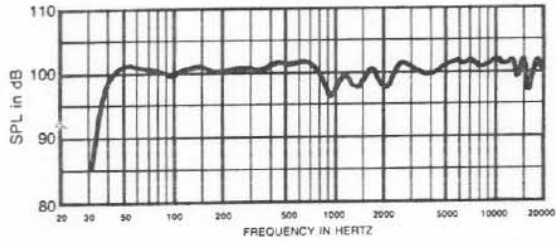

FIGURE 2 — MT-4A System Axial Frequency Response Using MTX-4A Electronics Unit (1 watt/1 meter into LF section)

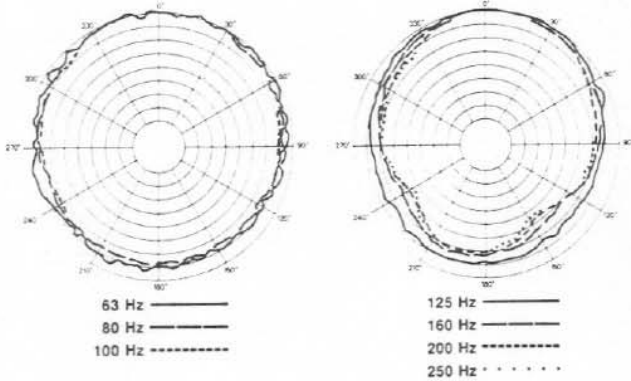

FIGURE 3 — MTL-4A Polar Response (1/3 octave, 4 volts/10 feet)

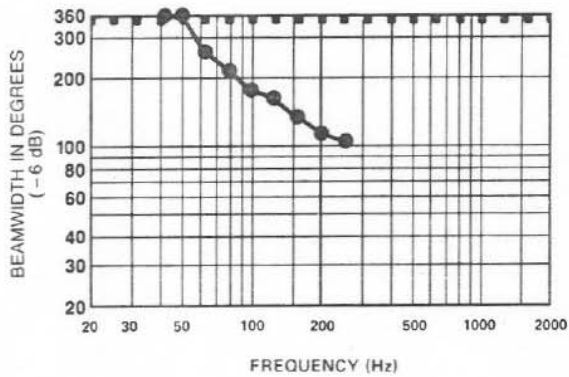

FIGURE 4 — MTL-4A Beamwidth vs. Frequency

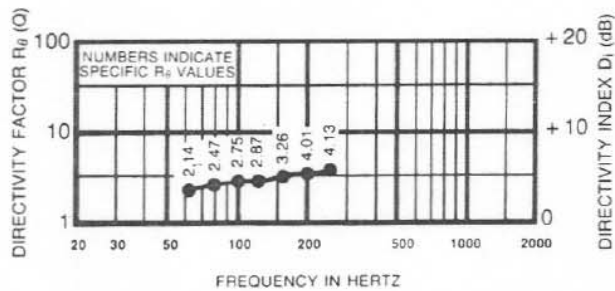

FIGURE 5 — MTL-4A Directivity Factor and Directivity Index vs. Frequency

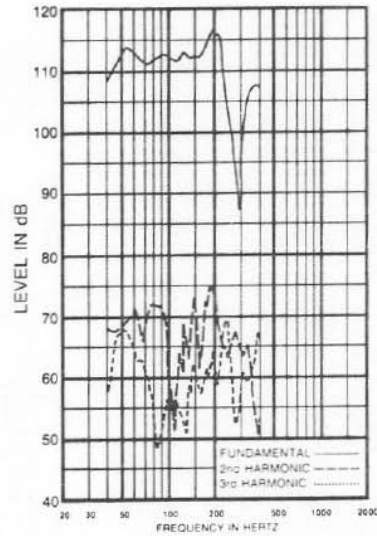

FIGURE 6 — MTL-4A Harmonic Distortion, 0.1 Rated Power Input (160 watts), 10 Feet on Axis

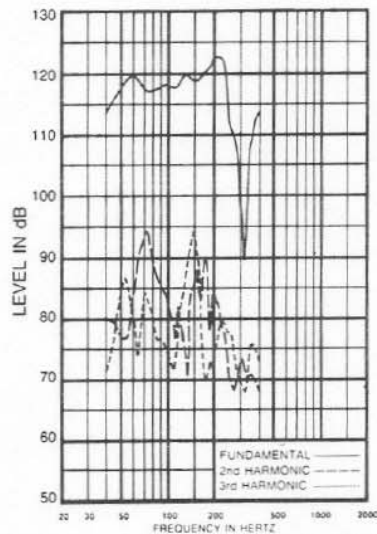

FIGURE 7 — MTL-4A Harmonic Distortion, 1.0 Rated Power Input (1600 watts), 10 Feet on Axis

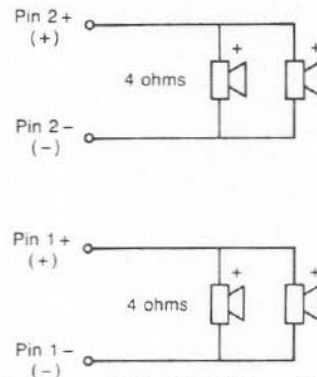

FIGURE 8 — MTL-4A Wiring Diagram

over conventional direct-radiating designs in a remarkably small enclosure. The MTL-4A is typically 2 to 3 dB more efficient than horn-loaded enclosures of equivalent size in the 40-80-Hz region. Additionally, this radical design allows for efficient heat-transfer from the loudspeakers to minimize thermal build-up during extended periods of high-power operation.

The DL18MT 18-inch woofer was designed specifically for manifolding to achieve optimal performance in the MTL-4A enclosure. Its design assures linear, low-distortion output. The high-power, high-excursion drive of the DL18MT is augmented by two exclusive Electro-Voice features: the Thermo Inductive Ring, TIR™, and PROTEF™ coating (U.S. Patent No. 4,547,632). The TIR acts as a control on drive inductance and, more importantly, provides a major heat-transfer path from the top of the drive coil, reducing thermal dynamic-range compression. PROTEF is a Teflon-based coating applied to the inside diameter of the top plate to physically protect the voice coil from rubbing during violent power peaks.

Designed to survive the rigors of the road, all versions of the MTL-4A are constructed of 14-ply birch plywood. The MTL-4AC and MTL-4ACF (flying option) are covered with black Ozite Super TNT carpeting, the most rugged in the industry. For permanent installations, the MTL-4AP and MTL-4APF (flying option) are available, finished with black textured paint. All versions feature a black nylon cloth grille. The MTL-4AF flying option incorporates a unique two-point flying system (see Hanging section).

APPLICATIONS

The MTL-4A is ideal for any professional touring or installation application requiring low-frequency reproduction at high sound pressure levels with low distortion. Manifold Technology maximizes the acoustic output per bulk volume and frontal area of the enclosure, enabling more compact systems and arrays than would be obtainable with conventional sound reinforcement enclosure designs.

The dimensions of the MTL-4A were chosen for efficient truck pack and high-density array design. The cabinets may be stacked three high and three wide in a standard tractor trailer allowing for over 14,000 watts of bass system to be accommodated in only three feet of truck floor length. Careful attention was paid to details to provide both the touring company and the sound contractor with a convenient and time-saving professional sound reinforcement package.

For full-range applications the MTL-4A may be combined with the MTH-4A midbass/midrange/high-frequency loudspeaker system. Designed as an integrated package, both systems have identical external dimensions and matching hardware. For optimum acoustic performance, the MTX-4A four-way electronic crossover/equalizer/time-delay unit should be used with the full-range MT-4A system.

FREQUENCY RESPONSE

The MTL-4A frequency response, shown in Figure 1, was measured on axis in the farfield in an anechoic environment using a one-watt (1.414 V) swept one-third-octave input and

by using the inverse-square law. The frequency response of the complete MT-4A system was set up using the MTX-4A electronic crossover/equalizer/time-delay unit with one watt of power (1.414 V) being delivered to the midband of the MTL-4A.

DIRECTIVITY

The MTL-4A directional characteristics were measured by running a set of polar-response curves in EV's large anechoic chamber. The test signal was one-third-octave pink noise centered at the frequencies indicated in Figure 3. Because the MTL-4A is essentially symmetrical, only a single polar-response curve is shown.

Additional typical information is provided in Figure 4 which shows 6-dB-down beamwidth versus frequency. Figure 5 shows the directivity factor and directivity index versus frequency. AcoustiCADD™ data is available for the MTL-4A.

DISTORTION

Following AES (Audio Engineering Society) recommended practice, plots of second- and third-order harmonic distortion for 0.1 rated input power are shown in Figure 6. Figure 7 shows distortion at full rated input power.

POWER HANDLING CAPACITY

To our knowledge, Electro-Voice was the first U.S. manufacturer to develop and publish a power test closely related to real-life conditions. First, we use a random noise input signal because it contains many frequencies simultaneously, just like real voice or instrument program. Second, our signal contains more energy at extremely high and low frequencies than typical actual program, adding an extra measure of reliability. Third, the test signal includes not only the overall "long-term average" or "continuous" level which our ears interpret as loudness but also short-duration peaks which are many times higher than the average, just like actual program. The long-term average level stresses the speaker thermally (heat). The instantaneous peaks test mechanical reliability (cone and diaphragm excursion). Note that the sine-wave test signals sometimes used have a much less demanding peak value relative to their average level. In actual use, long-term average levels exist from several seconds on up, but we apply the long-term average for several hours, adding another extra measure of reliability.

Specifically, the MTL-4A is designed to withstand the power test described in EIA Standard RS-426A. The EIA test spectrum is applied for eight hours. To obtain the spectrum, the output of a white noise generator (white noise is a particular type of random noise with equal energy per bandwidth in Hz) is fed to a shaping filter with 6-dB-per-octave slopes below 40 Hz and above 318 Hz. When measured with the usual constant-percentage analyzer (one-third-octave), this shaping filter produces a spectrum whose 3-dB-down points are at 100 Hz and 1,200 Hz with a 3-dB-per-octave slope above 1,200 Hz. This shaped signal is sent to the power amplifiers with continuous power set at 800 watts into each of the 3.45-ohm EIA-equivalent-impedance inputs (52.5 volts true RMS), resulting in a total of 1,600 watts of continuous power being delivered to the

6 dB above the continuous power, or 6,400 watts peak (105 volts peak per input). This procedure provides a rigorous test of both thermal and mechanical failure modes.

SUBPASSBAND SPEAKER PROTECTION

Below the enclosure tuning frequency, cone excursion increased rapidly. Since acoustic output is also falling rapidly, there is no utility in driving the system with signals much below the tuning frequency. While such signals may be in the program material, they are often extraneous such as from recording surface irregularities (strong 5-25-Hz components) or a dropped microphone. The DL18MT very-low-frequency reproducers are ruggedly designed and have high maximum excursion before damage (± 0.5 inch). However, high-output subwoofer systems such as the MTL-4A should be protected by a high-pass filter with a 3-dB down corner frequency of 30 Hz. Below the corner frequency, a rolloff of at least 12 dB per octave should be used.

Without protection, subpassband signals may "bottom" the woofers. Damage will probably result, especially after repeated occurrences. Even if bottoming does not occur, the subpass-band signals waste amplifier power and modulate (distort) the frequencies which are within the MTL-4A operating range. Much "woofer distortion" or "muddy bass" can be attributed to lack of subpassband protection.

LARGE-SIGNAL PERFORMANCE

Speakers have two limitations that govern their large signal, or maximum-output performance capabilities. One is the speaker's long term average power capacity (related to thermal, or heat destruction). The second is its maximum linear cone-excursion ability (as expressed in the Thiele-Small parameter, X_{max}). One of the benefits of the MTL-4A Manifold Technology® design is that with full power input (1,600 W) the maximum recommended cone excursion of the DL18MT woofer is not exceeded for any frequency above the box-tuning frequency of 37 Hz. Therefore, the only limitation of the MTL-4A low-frequency system in the recommended frequency range is the thermal input power. Cone excursion increases substantially below box tuning and operation is not recommended for frequencies below 37 Hz (see Subpassband Speaker Protection section).

USE IN MULTIPLES

MTL-4A's may be used in multiples to increase acoustic output. In the following discussion, it is assumed that all speaker cones are operating in unison (in phase) when a common signal is applied. A 6-dB increase in maximum acoustic output results when two speaker systems are located side by side. For operation at very low frequencies, the woofer cones "mutually couple," acting as one system with cone area and power-handling capacity twice that of a single system. The doubling of cone area doubles efficiency, providing a 3-dB increase in sound pressure level. The second 3 dB comes from the doubling of power capacity.

Mutual coupling occurs when the frequency is such that the center-to-center distance between the two woofer manifolds is less than about one-half wavelength. When the distance is greater than one-half wavelength, as would occur if two MTL-4A's were widely spaced, the level increase tends to be limited to the 3-dB power-handling increase

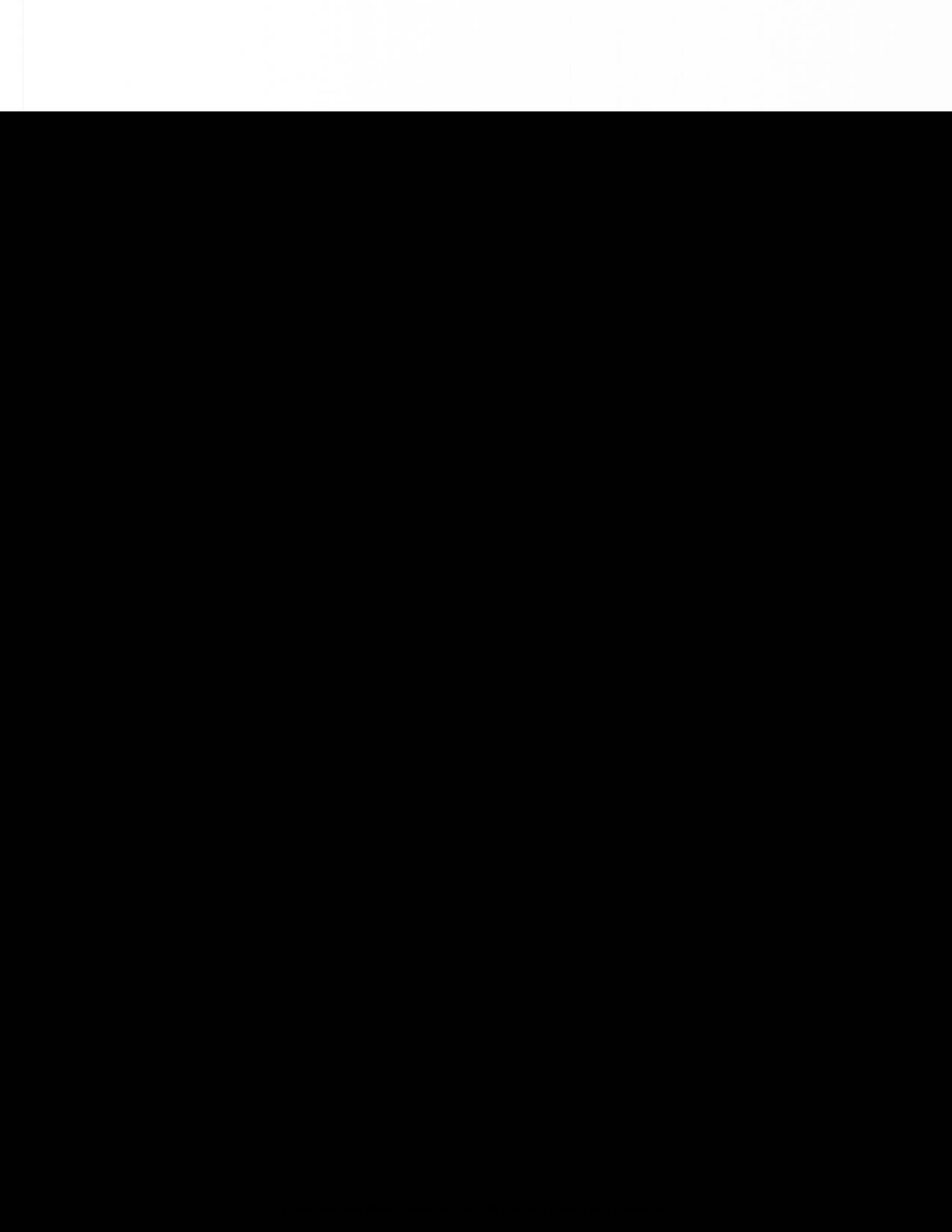

SYSTEM POSITIONING

Subwoofer systems such as the MTL-4A are often located on the floor. This is both convenient and provides a desired high coverage.

Floor location provides the acoustic half-space environment associated with the 11.3 system efficiency noted in the Specifications section. Location at a floor-wall junction (acoustic quarter space) doubles efficiency (a 3-dB increase in acoustic power level) and tends to promote the full excitation of more room modes, or standing waves, important in achieving maximum overall bass output in the room. Corner placement (acoustic eighth space) doubles efficiency again and guarantees excitation of all room modes. (Such placement for maximum efficiency and room-mode excitation is not necessary and may not be desirable or possible for a variety of reasons, including esthetics and practicality.)

The MTL-4A can also be successfully operated away from any nearby acoustic boundaries, particularly when multiple systems are used for increased output ability (see Use in Multiples section), such as in a flown concert system.

CROSSOVER, EQUALIZATION AND TIME DELAY

The usable frequency response of the Electro-Voice MTL-4A low-frequency loudspeaker system is 32-225 Hz. For maximum performance of the MTL-4A in a full-range application, the addition of the Electro-Voice MTH-4A midbass/midrange/high-frequency loudspeaker system is recommended. This combination forms the MT-4A full-range high-level sound-reinforcement system. For maximum acoustic performance, use the Electro-Voice MTX-4A electronic crossover/equalizer/time-delay unit.

The MTX-4A is an electronics unit dedicated for use with the MT-4A loudspeaker system. The MTX-4A is a four-way electronic crossover with fixed crossover frequencies of 160, 1,600 and 10,000 Hz that utilizes Linkwitz-Riley 24-dB-per-octave filters and fixed time delay in each band to achieve time alignment and zero lobing error. In addition, there is equalization on the high-frequency outputs to compensate for the compression driver power response rolloff and a 32-Hz high-pass filter to protect the woofers from infrasonic frequencies. The result is an anechoic frequency response with 3-dB down points at 37 Hz and 20,000 Hz (see Figure 2). The gain structure of the MTX-4A is setup so that, with the output level controls set in their zero-detent position, the MT-4A speaker system will have a flat frequency response (as shown in Figure 2) when amplifiers having identical gain are used.

CONNECTION

The MTL-4A has four 8-ohm loudspeakers wired in paralleled pairs resulting in two 4-ohm loads. For more information, contact Whirlwind Music Distributors, Inc. To find your local Pro Co or Whirlwind or Neutrik dealer, contact:

Pro Co Sound, Inc.
135 E. Kalamazoo Ave.
Kalamazoo, MI 49007

Whirlwind Music Distributors, Inc.
P.O. Box 1075
Rochester, NY 14603

Neutrik USA, Inc.
195-S3 Lehigh Ave.
Lakewood, NJ 08701

HANGING

The MTL-4ACF (carpeted) and MTL-4APF (painted) are flying-option versions. In addition to a time savings in setup, their unique two-point flying system permits a wide range of angle adjustment and offers maximum flexibility in array design and implementation for both the sound touring company and the sound contractor.

Each enclosure side (not the top and bottom) has two tracks, placed to facilitate proper suspension and arraying. The surface of the tracks lies below the enclosure surface, to avoid any box-to-box interference problems during system transportation. The tracks mate with Kinedyne 32102-1 and 32111-1 double-stud ring fittings. Electro-Voice offers a complete line of flying accessories for the MT-4A speaker systems.

CAUTION: The MTL-4A speaker systems should be suspended overhead only in accordance with the procedures and limitations specified in the Flying Manual included with the flying loudspeakers.

FIELD SERVICE

The MTL-4A was designed for expedient field repair. To access the drivers, first remove the nylon grille. The grille may be removed by simply grabbing the tabs and gently pulling it off. Next, remove the eight 1/4-20 hex-head bolts which secure each woofer. Use a 3/8-inch nutdriver or a ratchet with a 3/8-inch socket. The woofers then slide straight out of the enclosure. Subwoofer: Complete DL18MT 18-inch woofer. EV Part No. 818-0882.

Complete service information can be found in the Service Data Sheet available from the Service Department in Buchanan, Michigan.

ARCHITECTS' AND ENGINEERS' SPECIFICATIONS

The loudspeaker system shall be a low-frequency system with four manifolded 18-inch low-frequency woofers. Each woofer

shall have an 8-ohm, 2.5-inch-diameter voice coil constructed of edge-wound rectangular copper wire, and shall be capable of handling an RMS current of 26.5A.

The loudspeaker system shall be the Electro-Voice MTL-4A (MTL-4AC, MTL-4ACF, MTL-4AP and/or MTL-4APF).

WARRANTY (Limited)

Electro-Voice MT Speakers and Speaker Systems (excluding active electronics) are guaranteed for five years from date of purchase against malfunction due to defects in workmanship and materials. Electro-Voice MT flying hardware (rigging straps and enclosure-mounted hardware) is guaranteed for one year from date of original purchase against malfunction due to defects in workmanship and materials. If such malfunction occurs, unit will be repaired or replaced (at our option) without charge for materials or labor if delivered prepaid to the proper Electro-Voice service facility. Unit will be returned prepaid. Warranty does not extend to finish, appearance items, burned coils, or malfunction due to abuse or operation under other than specified conditions, nor does it extend to incidental or consequential damages. Some states do not allow the exclusion or limitation of incidental or consequential damages, so the above exclusion may not apply to you. Repair by other than Electro-Voice or its authorized service agencies will void this guarantee. A list of authorized service centers is available for Electro-Voice, Inc., 600 Cecil Street, Buchanan, MI 49107 (616-695-6831); and Electro-Voice West, 8234 Doe Ave., Visalia, CA 93291 (209-651-7777). Or Mark IV Audio Canada, Inc., 345 Herbert St., Gananoque, Ontario, Canada K7G 2V1 (613-382-2141); Mark IV Audio, A.G., Keltenstrasse 5, CH-2563 Ipsach, Switzerland (41-32-51-6833); Mark IV Vertriebs, GmbH, Larchenstrasse 99, 6230 Frankfurt/Main 80, West Germany (49-69-380-100); Mark IV Audio Japan, Ltd., 2-5-60 Izumi, Suginami-ku, Tokyo 168, Japan (81-3-325-7900); Electro-Voice Pty., Unit 24/Block C, Slough Business Park, Slough Ave., Silverwater N.S.W. 2141 Australia (61-2-648-3455). This warranty gives you specific legal rights which may vary from state to state or province to province.

Service and repair address for this product: Electro-Voice, Inc., 600 Cecil Street, Buchanan, MI 49107.

Specifications subject to change without notice.



ELECTRO-VOICE, INC., 600 Cecil Street, Buchanan, Michigan 49107

MANUFACTURING PLANTS AT ■ BUCHANAN, MI ■ NEWPORT, TN ■ SEVIERVILLE, TN ■ OKLAHOMA CITY, OK ■ GANANOQUE, ONT.
© Electro-Voice Inc. 1991 ■ Litho in U.S.A. Part Number 531751 — 150

a MARK IV company

Free Manuals Download Website

<http://myh66.com>

<http://usermanuals.us>

<http://www.somanuals.com>

<http://www.4manuals.cc>

<http://www.manual-lib.com>

<http://www.404manual.com>

<http://www.luxmanual.com>

<http://aubethermostatmanual.com>

Golf course search by state

<http://golfingnear.com>

Email search by domain

<http://emailbydomain.com>

Auto manuals search

<http://auto.somanuals.com>

TV manuals search

<http://tv.somanuals.com>