

## T15i

### Two-Way Trapezoidal Speaker System

- HS-style suspension hardware is pre-installed, eyebolts are included - may be suspended vertically or horizontally
- Enclosure is paintable, (supplied with white, textured paint)
- Ring-Mode Decoupling (RMD™) for increased intelligibility
- PRO™ circuit provides HF driver protection
- Rotatable constant-directivity 60° x 40° horn
- 250-watt long-term rms power capacity
- Full-range, passive network included

#### Description

The compact, trapezoidal-shaped Electro-Voice T15i is a 250-watt, two-way, full range, constant-directivity speaker system. This system combines professional-quality components, arranged in a time-coherent vertical array, with an, installation-friendly, vented enclosure. The result is clear and articulate, high-quality sound for permanent installation at a reasonable cost.

The enclosure is constructed of 13-ply void-free, birch plywood. This high-strength shell is painted with a textured, neutral, white paint. Suspension hardware is preinstalled and three eyebolts are included in the shipping carton. Small rubber feet and mounting screws are also included but not attached to each system for the less likely situation where the system will not be suspended.

The high-frequency section of the T15i utilizes the HP64M 60° x 40° constant-directivity horn driven by a wide-bandwidth, titanium-diaphragm DH2010A driver. This driver uses a unique convex-drive phasing-plug structure for smooth and extended high-frequency performance. The voice coil is coupled to the diaphragm with EV's exclusive Resonant Drive™ technology. This in-

creases and smoothes the high-frequency response and reduces the amount of internal equalization required for flat frequency response.

E-V's self-resetting PRO™ circuit is built into the crossover network to guard the compression driver from damage. If input power to the driver exceeds the nominal rating, the PRO™ circuit is activated, reducing the power delivered to the driver by 6 dB. The system will remain in this mode of operation until input power is reduced to a safe level.

The optimally vented bass section of the T15i is designed using Thiele-Small parameters for efficient performance to below 47 Hz. The high-excursion 15-inch woofer features beryllium-copper lead wires with a low-mass, extended-length, edge-wound voice coil and high-temperature materials.

#### Ring-Mode Decoupling (RMD™)

The T15i controls both acoustical and mechanical ring modes to provide dramatically increased intelligibility, using techniques learned from the development of the Electro-Voice X-Array™ concert speakers. There is much less coloration of the sound from resonating sources, leaving

only the intended sound to be heard by the audience.

#### Notes on installation

Any suspension system is only as strong as its weakest link. The installer must ensure the mounting points have sufficient load-bearing capability to safely suspend the cabinet. The initial support cables or chains should be as close to vertical as possible and never more than 30° from vertical. Once the system is installed none of the chains or cables should touch or rub against the cabinet. Local codes and regulations, if they exceed Electro-Voice's recommendations, should be followed at all times. Electro-Voice recommends that a minimum safety factor of 8:1 be adopted. The Electro-Voice HS-style suspension components supplied in the T15i exceed this recommended safety factor when the system is installed in compliance with Electro-Voice recommendations.

It is the installer's responsibility to ensure the speaker system has been installed correctly. Electro-Voice strongly recommends that all suspended items be inspected at least once a year and any damaged parts be replaced immediately.

# T15i Two-Way Trapezoidal Speaker System

**Figure 5—T15i One-Third-Octave Polar Responses (anechoic environment, 4 volts/6.10 meters (20 feet))**

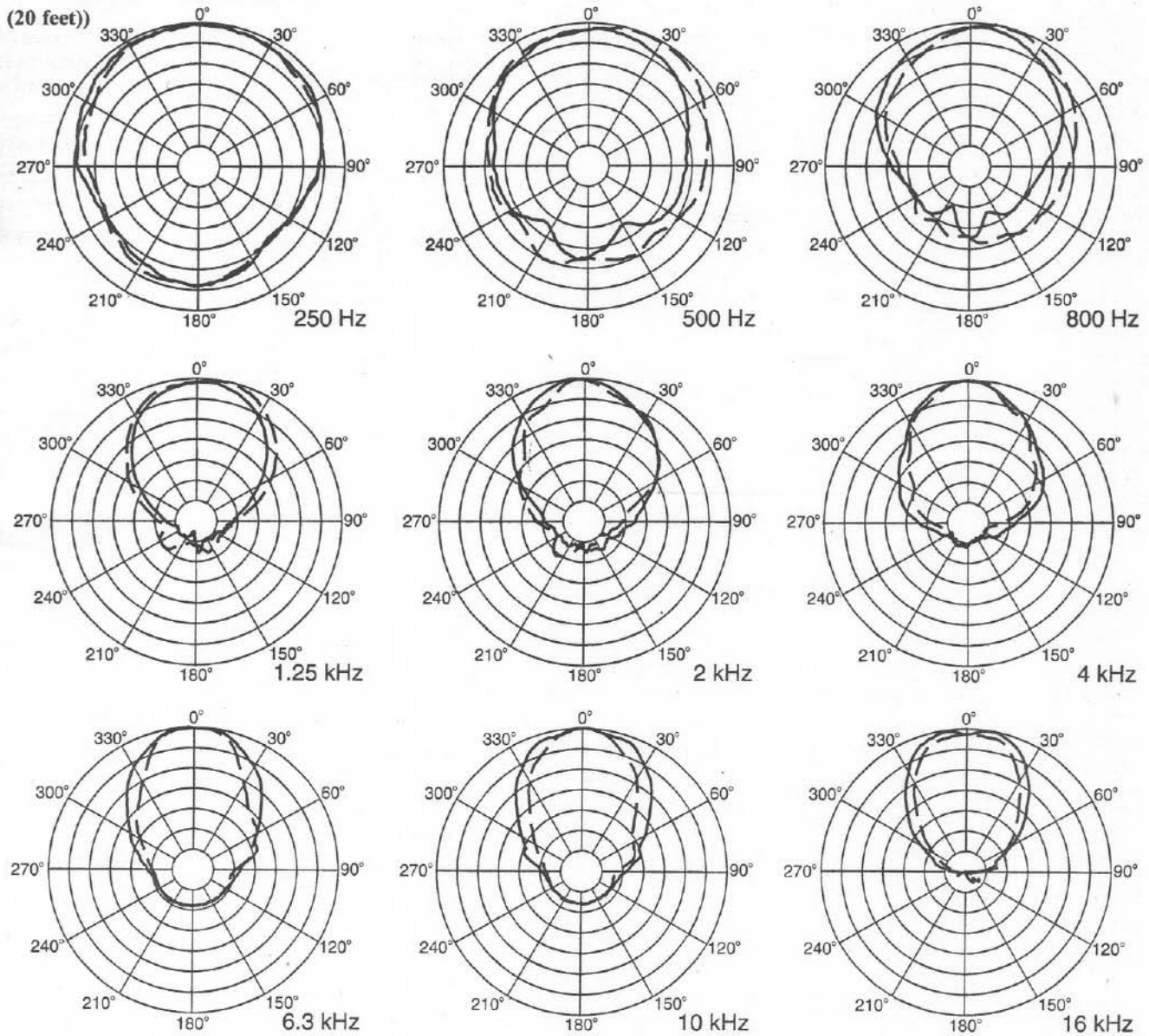

T15i Two-Way Trapezoidal Speaker System

**Figure 6—T15i Beamwidth vs. Frequency (anechoic environment)**

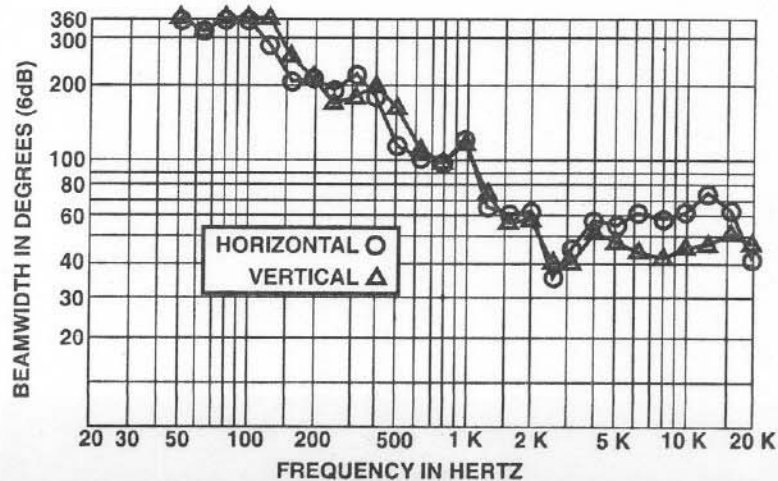

# T15i Two-Way Trapezoidal Speaker System

**Figure 2—T15i Harmonic Distortion Response 10% Rated Power Input (25 watts), (anechoic environment, 3.05 meters (10 feet) on axis)**

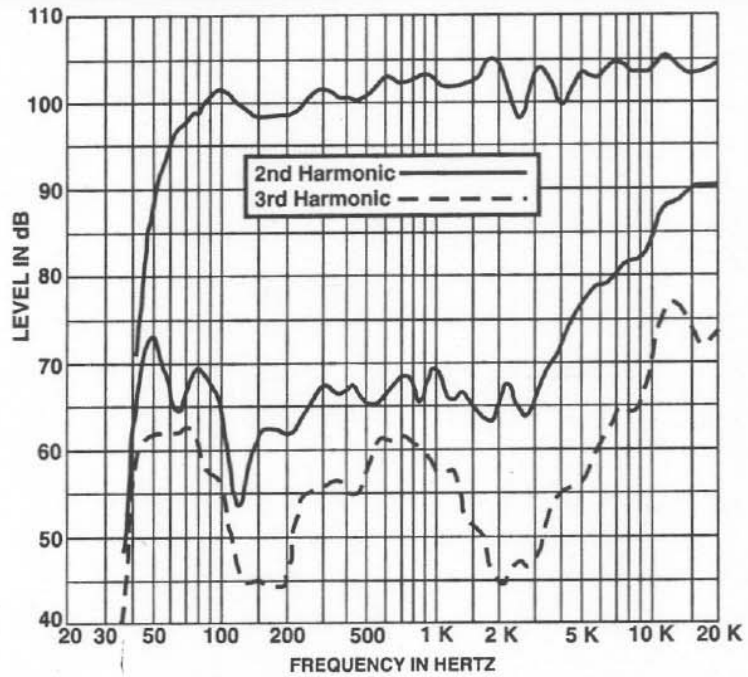

**Figure 3—T15i Impedance Curve**

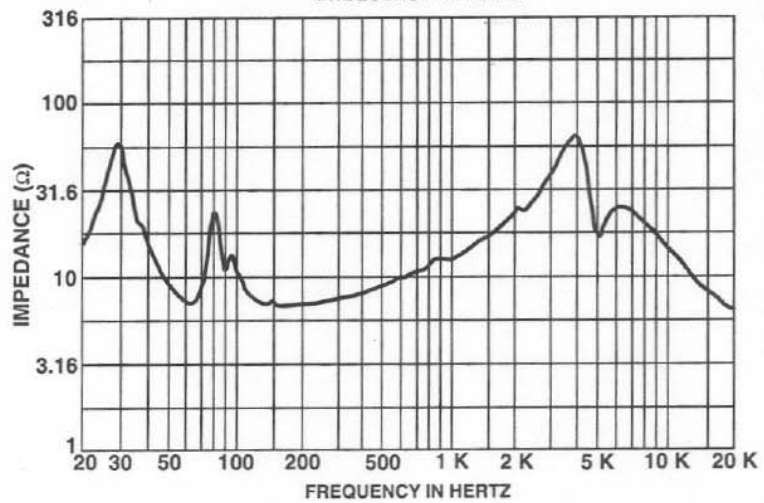

**Figure 4—T15i Dimension Line Drawing**

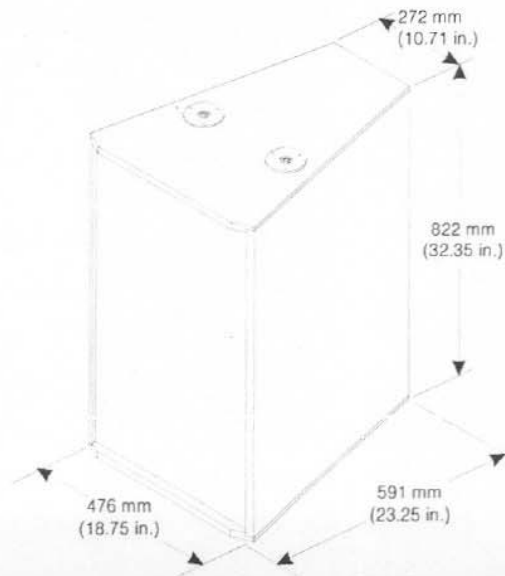

T15i Two-Way Trapezoidal Speaker System

# T15i Two-Way Trapezoidal Speaker System

All Electro-Voice HS- and HST- systems follow the same principles. Put minimum stress on the cabinet and make each cabinet hang independently of any other device.

## Suspending the Electro-Voice T15i Speaker System

Part of the T15i's versatility is that it can be mounted either vertically or horizontally, and has a rotatable horn. The mounting system is conceptually very simple. Two aluminum tubes pass vertically through the cabinet and each is secured via two oversize cast brackets (threaded flanges). The enclosure is sandwiched between the four (two on each end) brackets. The enclosure is essentially resting between the brackets.

When installing the T15i, two of the three supplied forged eyebolts are screwed into the upper two brackets. The third eyebolt should be screwed into the appropriate T-nut on the rear panel of the enclosure. When mounting the enclosure vertically, use the lower T-nut. When mounting the enclosure horizontally, use the T-nut located in the center of the rear panel of the enclosure. This is necessary for aiming the system. The center of gravity is arranged so the enclosure is directed towards the ceiling. In order to provide a downward or horizontal projection angle, the pull-up point must be used.

If multiple cabinets are to be suspended, each system requires its own rigging points. **Systems must not be suspended from each other.** The eyebolts must be connected using suitably rated chain with connectors such as shackles or threaded chain connectors, or suitably rated aircraft cables to suspend and aim the system.

## Constant-Directivity Speaker System

The crossover frequency and speaker component geometries have been selected so that the directional characteristics of the woofer and constant-directivity horn match at the crossover frequency (approximately 90° circular coverage patterns for each) to create a special system type—the constant-directivity system. At higher frequencies the horizontal coverage pattern remains constant and the vertical pattern smoothly transitions to a 40° angle above 4,000 Hz. Response within

the 60° x 40° rated coverage angle is uniform, which means dependable audience coverage without hot spots or dead zones at certain frequencies. The 60° x 40° dispersion characteristic also helps avoid early reflections from nearby floor-or side-wall surfaces which could degrade intelligibility. The controlled directivity of the high- and low-frequency transducers also eliminates response irregularities caused by diffraction off nearby enclosure edges and, in combination with an essentially flat on-axis frequency response, produces a total acoustic power output that is uniform with frequency.

## Enclosure Construction

A combination of dado-cut joints, tough adhesives and proper bracing ensures a sonically dead enclosure free from panel resonances. The flying hardware is preinstalled in the T15i. The exterior of the T15i is covered with a white, textured paint that is paintable if the installer desires.

## Rotating the High-Frequency Horn

The T15i high-frequency horn may be easily rotated about its major axis, providing coverage independent of enclosure orientation. First remove the enclosure grille, then the horn. Both are affixed with #2 Phillips-head screws. Rotate the horn 90° about its axis and reinstall the components.

## Connections

Power connection to the T15i is made through Neutrik Speakon® connectors. Both connectors are wired in parallel. Pins 1+/1- is wired to the system. Pins 2+/2- in each connector are linked together allowing custom wiring schemes.

## Frequency Response

The combination of a 15-inch woofer, wide-bandwidth high-frequency driver and an equalized crossover results in the wide and smooth overall response shown in Figure 1. The T15i's axial frequency response was measured in Electro-Voice's large anechoic chamber at a distance of 10 feet with a swept sine-wave input of 4 volts. Figure 1 has been

averaged and corrected for 1 watt/1 meter.

## Directivity

A unique feature of the T15i is the constant-directivity dispersion provided by the 60° x 40° horn. The polar response of the system at selected one-third-octave bandwidths is shown in Figure 5. These polar responses were measured in an anechoic environment at 10 feet using one-third-octave pink-noise inputs. The frequencies selected are fully representative of the polar response of the system. Beamwidth of the system utilizing the complete one-third-octave polar data is shown in Figure 6.  $R_{\theta}$  and directivity index (D<sub>i</sub>) are plotted in Figure 7.

## Power-Handling Capacity

Electro-Voice components and systems are manufactured to exacting standards, ensuring they will hold up, not only through the most rigorous of power tests, but also through continued use in arduous, real-life conditions. The EIA Loudspeaker Power Rating Full Range (ANSI/EIA RS-426-A 1980) uses a noise spectrum which mimics typical music and tests the thermal and mechanical capabilities of the components. Electro-Voice will support relevant additional standards as and when they become available. Extreme, in-house power tests, which push the performance boundaries of the woofers, are also performed and passed to ensure years of trouble-free service.

Specifically, the T15i passes ANSI/EIA RS-426-A 1980 with the following values:

$$R_{SR} = 5.98 \text{ ohms } (1.15 \times R_E)$$

$$P_{E(MAX)} = 250 \text{ watts}$$

$$\text{Test voltage} = 38.67 \text{ volts rms,}$$

$$77.33 \text{ volts peak (+6dB)}$$

The "peak" power-handling capacity of a woofer is determined by the peak test voltage amount. For the S15, a 77.33-volt peak test voltage translates into 1,000-watts short-term peak power-handling capacity. This is the equivalent of four times the "average" power-handling capacity, and is a peak that can be sustained for only a few milliseconds. However, this sort of short-duration peak is very typical in speech and music. Provided



## T15i Two-Way Trapezoidal Speaker System

the amplifier can reproduce the signal accurately, without clipping, the system will perform accurately and reliably, even at these levels.

### Architects' and Engineers' Specifications

The loudspeaker system shall be a two-way, full-range design consisting of a 381-mm (15-inch) woofer in a vented, trapezoidal-shaped enclosure, a high-frequency compression driver mounted on a rotatable 60° x 40° constant-directivity horn and a passive crossover/equalizer network. The loudspeaker shall meet the following performance criteria: frequency response of 50-16,000 Hz, -3 dB; power handling of 250-watts long term and 1,000-watts short term with a shaped random-noise input per EIA Standard RS-426A; sensitivity of 98-dB SPL at 1 meter with a 1-watt, 300-2,000-Hz pink-noise input; 6-dB-down horizontal coverage angle of 60° ±15° in the 3,200-16,000-Hz range; 6-dB-down vertical coverage angle of 40° ±12° in the 3,200-16,000-Hz range; crossover frequency of 2,900 Hz; nominal impedance of 8 ohms; and minimum impedance of 6.9 ohms. Input connections shall be two paralleled Neutrik Speakon® connectors. The enclosure shall be constructed of 13-ply void-free plywood, covered with a white, textured paint with a black steel grille. Hardware required to suspend the system overhead will be preinstalled. Suspension will be accomplished by a total of three 3/8 in. eyebolts (included). Dimensions shall be 822 mm (32.4 in.) high x 476 mm

(18.8 in.) wide at front x 272 mm (10.7 in.) wide at rear x 591 mm (23.3 in.) deep. Net weight shall be 35.5 kg (74 lb), estimated.

The loudspeaker system shall be the Electro-Voice T15i.

### Limited Warranty

Electro-Voice products are guaranteed against malfunction due to defects in materials or workmanship for a specified period, as noted in the individual product-line statement(s) below, or in the individual product data sheet or owner's manual, beginning with the date of original purchase. If such malfunction occurs during the specified period, the product will be repaired or replaced (at our option) without charge. The product will be returned to the customer prepaid. Exclusions and Limitations: The Limited Warranty does not apply to: (a) exterior finish or appearance; (b) certain specific items described in the individual product-line statement(s) below, or in the individual product data sheet or owner's manual; (c) malfunction resulting from use or operation of the product other than as specified in the product data sheet or owner's manual; (d) malfunction resulting from misuse or abuse of the product; or (e) malfunction occurring at any time after repairs have been made to the product by anyone other than Electro-Voice or any of its authorized service representatives. Obtaining Warranty Service: To obtain warranty service, a customer must deliver the product, prepaid, to Electro-Voice or any of its authorized service representatives together with proof of purchase of the

product in the form of a bill of sale or receipted invoice. A list of authorized service representatives is available from Electro-Voice at 600 Cecil Street, Buchanan, MI 49107 (616/695-6831 or 800/234-6831) and/or Electro-Voice West, at 8234 Doe Avenue, Visalia, CA 93291 (209/651-7777 or 800/825-1242). Incidental and Consequential Damages Excluded: Product repair or replacement and return to the customer are the only remedies provided to the customer. Electro-Voice shall not be liable for any incidental or consequential damages including, without limitation, injury to persons or property or loss of use. Some states do not allow the exclusion or limitation of incidental or consequential damages so the above limitation or exclusion may not apply to you. Other Rights: This warranty gives you specific legal rights, and you may also have other rights which vary from state to state.

Electro-Voice Speakers and Speaker Systems are guaranteed against malfunction due to defects in materials or workmanship for a period of five (5) years from the date of original purchase. The Limited Warranty does not apply to burned voice coils. Electro-Voice active electronics associated with the speaker systems are guaranteed for three (3) years from the date of original purchase. Additional details are included in the Uniform Limited Warranty statement.

Service and repair address for this product: Electro-Voice, Inc., 600 Cecil Street, Buchanan, Michigan 49107 (616/695-6831 or 800/234-6831).

Specifications subject to change without notice.

Figure 1—T15i Axial Frequency Response, (anechoic environment, 4 volts/3.05 meters (10 feet), normalized to 1 watt/1 meter)

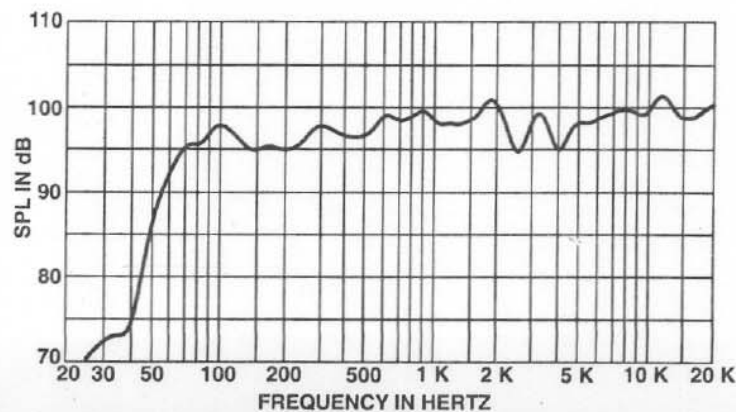

# T15i Two-Way Trapezoidal Speaker System

Figure 7—T15i Directivity vs. Frequency (anechoic environment)

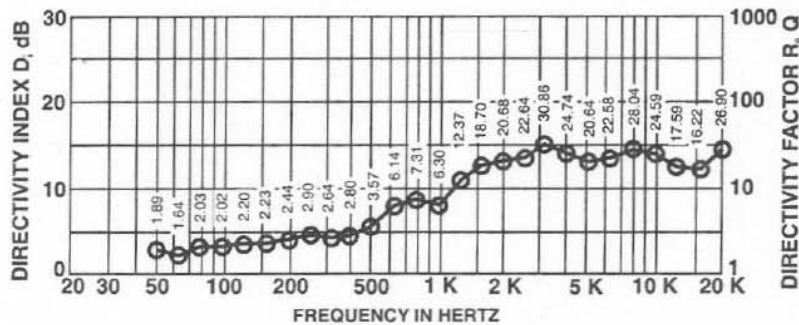

T15i Two-Way Trapezoidal Speaker System

## Specifications

**Typical Axial Frequency Response, Measured at 3.05 meters (10 Feet), Anechoic Environment (see Figure 1. Curve shown has been normalized for 1 watt/1 meter):**

62-20,000 Hz

**Low-Frequency 3-dB-Down Point:**

62 Hz

**Usable Low-Frequency Limit (10-dB-down point):**

47 Hz

**Half-Space Reference Efficiency:**

3.3%

**Long-Term Average Power-Handling Capacity per EIA Standard RS-426A, (see Power-Handling Capacity section):**

250 watts

**Sensitivity (SPL 1-watt, 1 meter input anechoic environment, swept sine wave),**

98 dB

**Nominal Coverage Angle,**

Horizontal: 60°

Vertical: 40°

**Beamwidth (angle included by 6-dB-down points on polar responses, indicated one-third-octave bands of pink noise, see Figure 6)**

**3,200 to 16,000 Hz Horizontal:**  
60° (+15°, -15°)

**3,200 to 16,000 Hz Vertical:**  
40° (+12°, -12°)

**Directivity Factor  $R_0$  (Q), 800- to 16,000-Hz Median (see Figure 7):**

19.5 (+11.4, -13.2)

**Directivity Index  $D_i$ , 800- to 16,000-Hz Median (see Figure 7):**

12.9 dB (+2.0 dB, -4.9 dB)

**Distortion Response (40 W), 10% Rated Input Power (on axis at 1 meter from system; see Figure 2),**

**Second Harmonic,**

100 Hz: 1.5%

1,000 Hz: 2.2%

10,000 Hz: 10.0%

**Third Harmonic,**

100 Hz: 0.6%

1,000 Hz: 0.6%

10,000 Hz: 1.8%

**Transducer Complement,**

**Low Frequency:**

381-mm (15-in.) woofer in a vented enclosure

**High Frequency:**

HP64M 60° x 40° horn mounted to DH2010A compression driver

**Enclosure-Tuning Frequency:**

55 Hz

**Enclosure Internal Volume:**

137 liters (4.84 cu. ft.)

**Driver Protection, High Frequency:**

6-dB-per-octave slope; Solid-state, self-resetting circuit (PRO™ circuit)

drops input 6 dB

**Enclosure Materials and Color:**

White, 13-ply void-free Russian birch plywood covered with a neutral white textured paint

**Grille:**

Black, powder coated steel, removable

**Dimensions, overall (w/o rubber feet attached),**

**Height:**

822 mm (32.35 in.)

**Width at Front:**

476 mm (18.75 in.)

**Width at Rear:**

272 mm (10.71 in.)

**Depth:**

591 mm (23.25 in.)

**Side-Wall Draft Angle:**

10°

**Net Weight:**

35.5 kg (78 lb)

**Shipping Weight:**

41.5 kg (91 lb)

# Electro-Voice®

600 Cecil Street, Buchanan, MI 49107

616/695-6831, 616/695-1304 Fax

©EVI Audio 1997 • Litho in U.S.A.

SPEAKERS—Full Range/Install

Part Number 534655 - 9750

## Free Manuals Download Website

<http://myh66.com>

<http://usermanuals.us>

<http://www.somanuals.com>

<http://www.4manuals.cc>

<http://www.manual-lib.com>

<http://www.404manual.com>

<http://www.luxmanual.com>

<http://aubethermostatmanual.com>

Golf course search by state

<http://golfingnear.com>

Email search by domain

<http://emailbydomain.com>

Auto manuals search

<http://auto.somanuals.com>

TV manuals search

<http://tv.somanuals.com>