



user manual

Built-In Electric Oven

We were thinking of you
when we made this product

Welcome to the world of Electrolux

Thank you for choosing a first class product from Electrolux, which hopefully will provide you with lots of pleasure in the future. The Electrolux ambition is to offer a wide variety of quality products that make your life more comfortable. You will find some examples on the cover in this manual. Please take a few minutes to study this manual so that you can take advantage of the benefits of your new machine. We promise that it will provide a superior User Experience delivering Ease-of-Mind. Good luck!

Contents

Safety instructions	5
Description of the Appliance	10
Before Using for the first time	13
Using the Oven	15
Uses, Tables and Tips	39
Cleaning and Care	65
What to do if ...	68
Installation Instructions	69
Disposal	75
Guarantee/Customer Service	76
Index	81
Service	82

The following symbols are used in this user manual:

 Important information concerning your personal safety and information on how to avoid damaging the appliance.

 General information and tips

 Environmental information



Safety instructions



This appliance conforms with the following EU Directives:

- 73/23/EEC dated 19.02.1973 Low Voltage Directive
- 89/336/EEC dated 03.05.1989 EMC Directive inclusive of Amending Directive 92/31/EEC
- 93/68/EEC dated 22.07.1993 CE Marking Directive

Electrical safety

- This appliance must only be connected by a **qualified installation engineer**.
- In the event of a fault or damage to the appliance: Take the fuses out or switch off.
- Should the door seal and the door seal surfaces be damaged, the appliance must not be operated until they are repaired.
- **Repairs** to the appliance must only be carried out by **qualified service engineers**. Considerable danger may result from improper repairs. If repairs become necessary, please contact our Customer Care Department or your dealer.

Children's safety

- Small children must be kept away from the appliance. Make sure that children do not touch the appliance when playing.
- Always heat baby food in jars or bottles with the lid or top off. After heating, stir or shake well, so that the heat is equally distributed. Before

you give the baby food to the child, **please be sure to test the temperature.**

- When operating the grill (alone or in combination with the microwave) the viewing window becomes hot. Therefore keep small children away from the door of the appliance.
- The appliance is fitted with a child safety device.

Safety whilst Using

- This appliance is intended to be used for cooking, roasting and baking food in the home.
- Take care when connecting electric appliances to sockets nearby. Do **not** allow connecting leads to come into contact with or to catch beneath the hot oven door.
- **Warning: Risk of burns!** The interior of the oven becomes hot during use.
- Using ingredients containing alcohol in the oven may create an alcohol-air mixture that is easily ignited. In this case, open the door carefully. Do not have embers, sparks or naked flames in the vicinity when opening the door.



Information on acrylamides

According to the latest scientific knowledge, intensive browning of food, especially in products containing starch, can constitute a health risk due to acrylamides. Therefore we recommend cooking at the lowest possible temperatures and not browning foods too much.

Microwave

- Only switch the appliance on when there is food inside it. With no food in it, the appliance could be overloaded.
- Only use **microwave safe** cookware (see section Uses, Tables and Tips: Suitable Cookware and Materials)
- To protect the interior or the door of the appliance from corrosion through escaping steam (condensed water), please dry the appliance thoroughly with a cloth after each use.
- Do not leave the appliance unattended, if food is being heated or cooked in disposable containers made of plastic, paper or other flammable materials.
- If smoke appears, keep the appliance closed. Switch off the appliance and disconnect from the power supply. Do not use the appliance under any circumstances, if it is no longer working correctly.
- When heating liquids always put a coffee spoon or a glass rod in the container to avoid boiling delay. With boiling delay the boiling temperature is reached without the typical steam bubbles rising.
If the container is shaken even slightly the liquid can suddenly boil over or spray violently. **Risk of burns!**

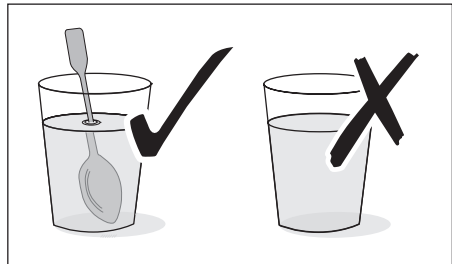

- Prick food with “skin” or “peel”, such as potatoes, tomatoes, sausages, with a fork several times before cooking so that the food does not burst.

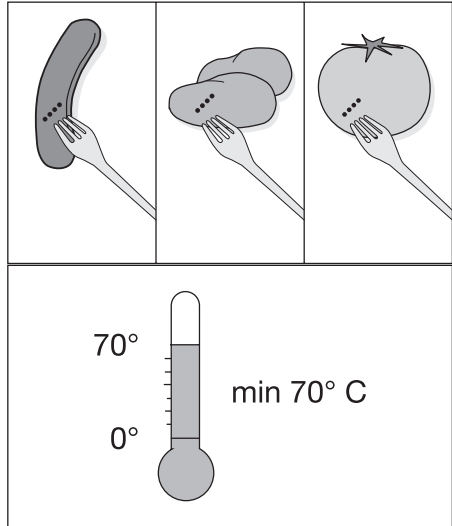

Ensure that a minimum temperature of **70°C** is reached when cooking/heating food. For this please refer to the power and time data in the tables. Never use mercury or liquid thermometers to measure the temperature of the food.

- Foods heated with microwaves give off heat to the cookware. **Use oven gloves or something similar.**
- Do not overcook the dishes by using powers and times that are too high. The food can dry out, burn or set itself alight in certain places.
- The interior of the oven, the grill heating element and the accessories become hot when the appliance is operating. Please be careful when handling them and use oven gloves or similar for this reason.

Risk of burns!

- Metal objects must be at least 2 cm from the walls of the oven interior and the oven door. Otherwise spark discharges may be caused and the appliance can be damaged.
- If not advised otherwise, do not use aluminium foil.
- Do not get anything caught between the door and the door frame.
- Always keep the door seal, the door seal surfaces and the interior clean. Lack of cleanliness in the appliance can lead to dangerous situations.
- Do not store any flammable materials inside the oven. These could ignite when the oven is switched on.

How to avoid damage to the appliance

- Do not line the oven with aluminium foil and do not place baking trays, pots, etc. on the oven floor, as the heat that builds up will damage the oven enamel.
- Fruit juices dripping from the baking tray will leave stains, which you will not be able to remove. For very moist cakes, use a deep tray.
- Do not put any strain on the oven door when open.
- Never pour water directly into the oven when it is hot. This could cause damage to or discoloration of the enamel.
- Rough handling, especially around the edges of the front panel, can cause the glass to break.
- Do not store any flammable materials inside the oven. These could ignite when the oven is switched on.
- Do not store any moist foods inside the oven. This could damage the oven enamel.
- After switching off the cooling fan, do not keep uncovered dishes in the oven. Moisture may condense in the oven interior or on the glass doors and may get into the units.



Note on enamel coating

Changes in the colour of the oven's enamel coating as a result of use do not affect the appliance's suitability for normal and correct use. They therefore do not constitute a defect in the sense of the warranty law.

Do not use the appliance...

... for cooking **eggs** in their shells (with fried eggs, pierce the yolks first) and snails, as it causes these items to burst.

... for heating large amounts of cooking oil (fondue, deep frying) and drinks with high alcohol content: **Spontaneous ignition! Risk of explosion!**

... for heating tightly closed containers, e.g. tins, bottles, screw top jars.

... for drying animals, textiles, grain pillows and gel cushions and other flammable materials: **Risk of fire!**

... for cookware made of porcelain, ceramic or earthenware that has small holes, e.g. on handles or unglazed bottoms. Moisture penetrating holes can cause the cookware to crack when it is heated.

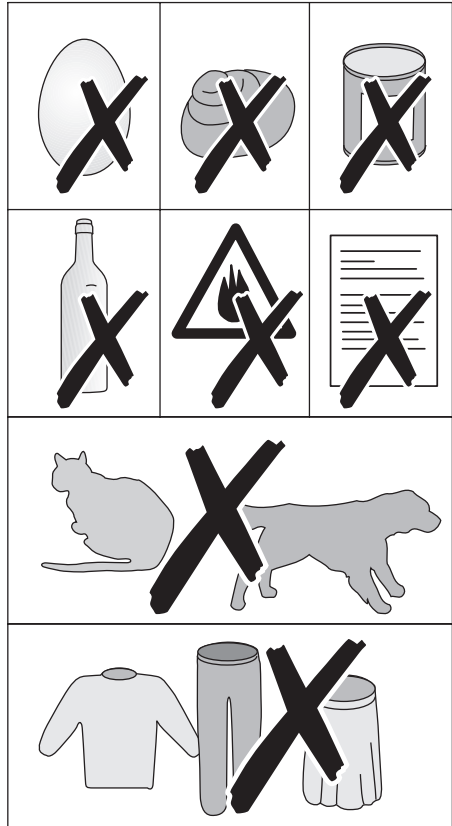

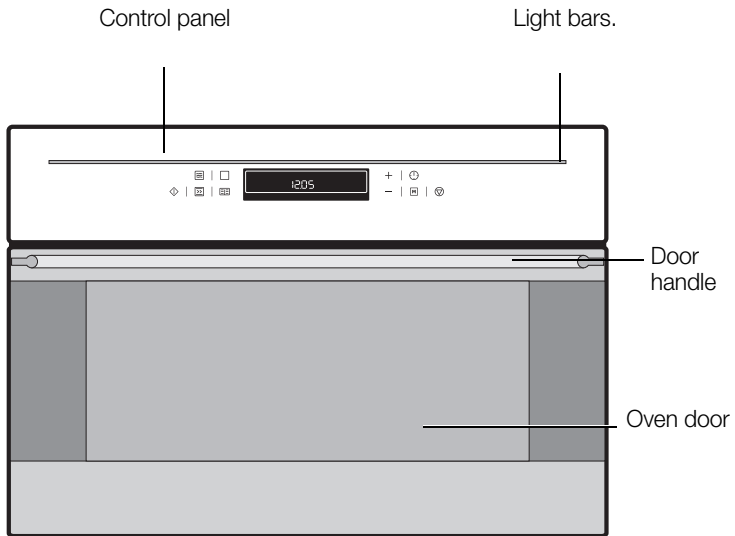

Description of the Appliance

General Overview



If no function is selected and nothing is changed on the appliance, the appliance switches itself off after 2 minutes, but the light bar remains on.

To switch the light bar off, switch the appliance on using the Start  button and switch it off again using the Stop  button (press twice).

Control Panel

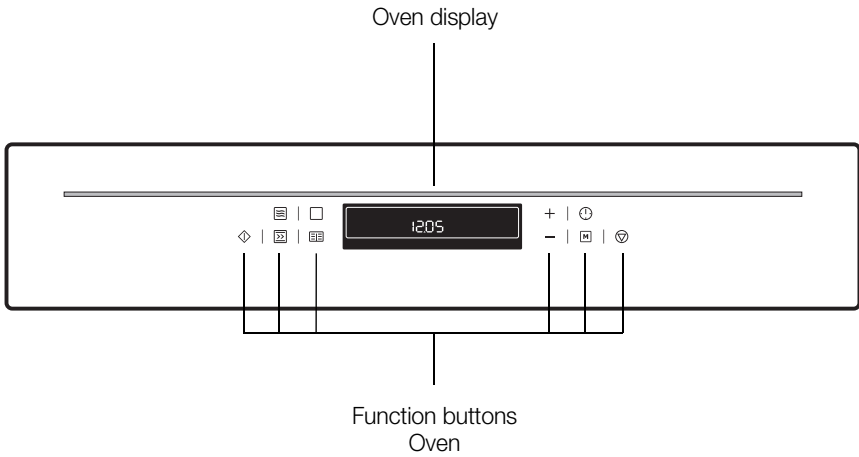

Oven Features

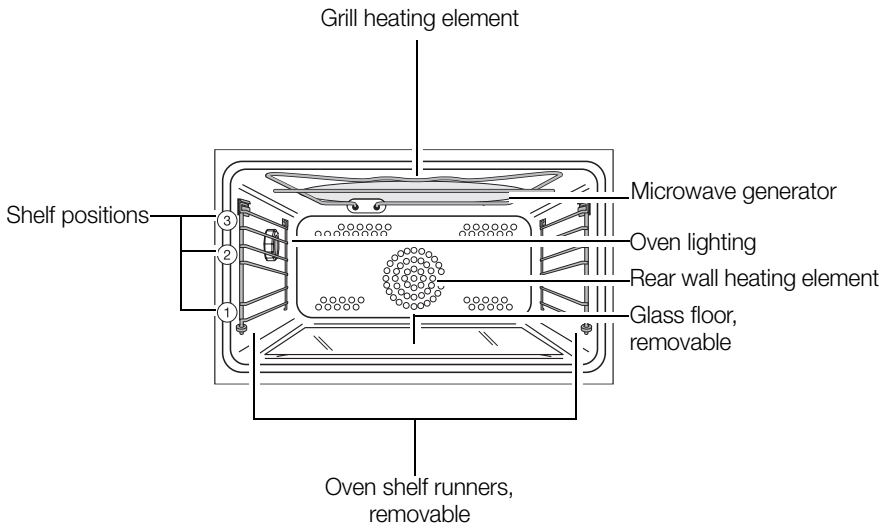

Oven accessories

Oven shelf

For cookware, cake tins, roasts and grilled foods.

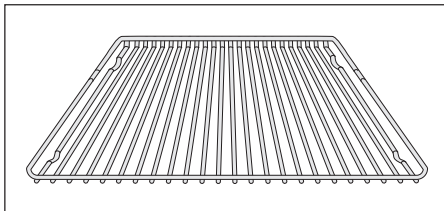

Baking tray

For cakes and biscuits
(not suitable for microwave use)

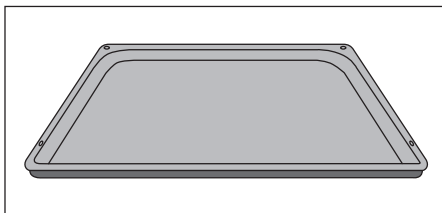



Before Using for the first time

Setting and changing the time



The oven only operates when the time has been set.

When the appliance has been connected to the electrical supply or when there has been a power cut, the symbol for Time  automatically flashes.

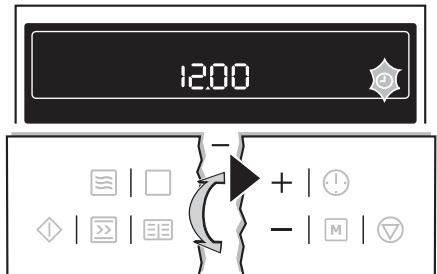

1. To change a time of day that has already been set, press the Clock Functions  button repeatedly until the symbol for Time  flashes.
2. Using the + or – button, set the current time.



After about 5 seconds, the flashing stops and the clock displays the time of day set.

The appliance is now ready to use.



The time can only be modified, if the child safety device is deactivated, none of the clock functions Countdown , Cook time  or End time  nor any oven functions are set.

Initial cleaning

Clean the oven before using it for the first time.



Important: Do not use caustic or abrasive cleaning agents! These can damage the oven surfaces.





For the metal surfaces, use commercially available cleaning agents.

1. Open the oven door.
The oven light is lit.
2. Remove all oven accessories, and clean them with warm water and a scouring agent.
3. Wash the oven in the same way, and wipe dry.
4. Wipe the front of the appliance with a damp cloth.



Getting to know the appliance

The appliance can be operated in test mode for testing or performing all operating steps. The oven does not heat up.

Switching test mode on

1. **Switch off** the appliance using the Stop  button.
2. Press and hold Baking/Roasting Programmes  and + buttons at the same time until an acoustic signal sounds and “d” lights up in the display.

Switching test mode off

1. **Switch off** the appliance using the Stop  button.
2. Press and hold Baking/Roasting Programmes  and + buttons at the same time, until a signal sounds and “d” goes out in the display.

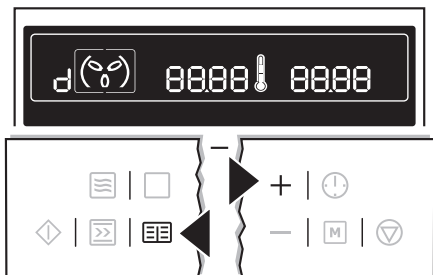

Using the Oven

The Electronic Oven Control



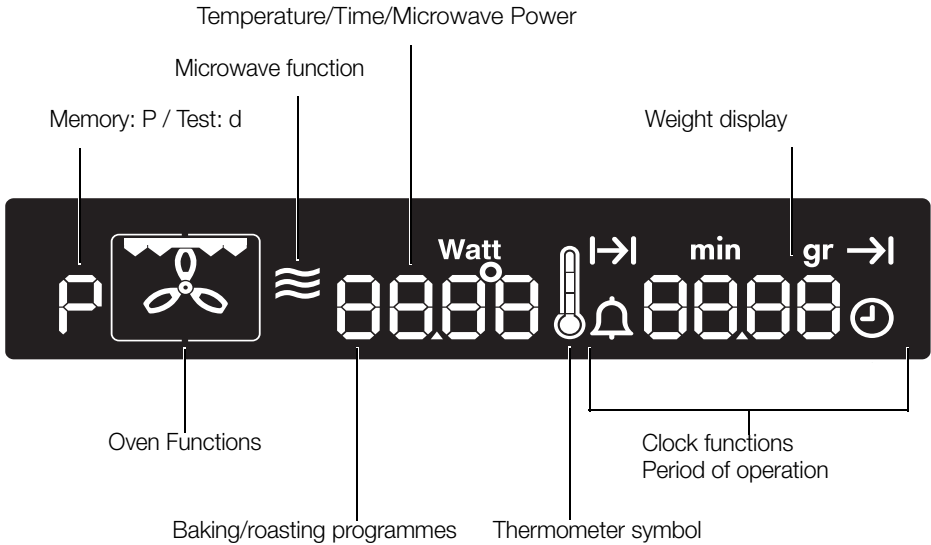

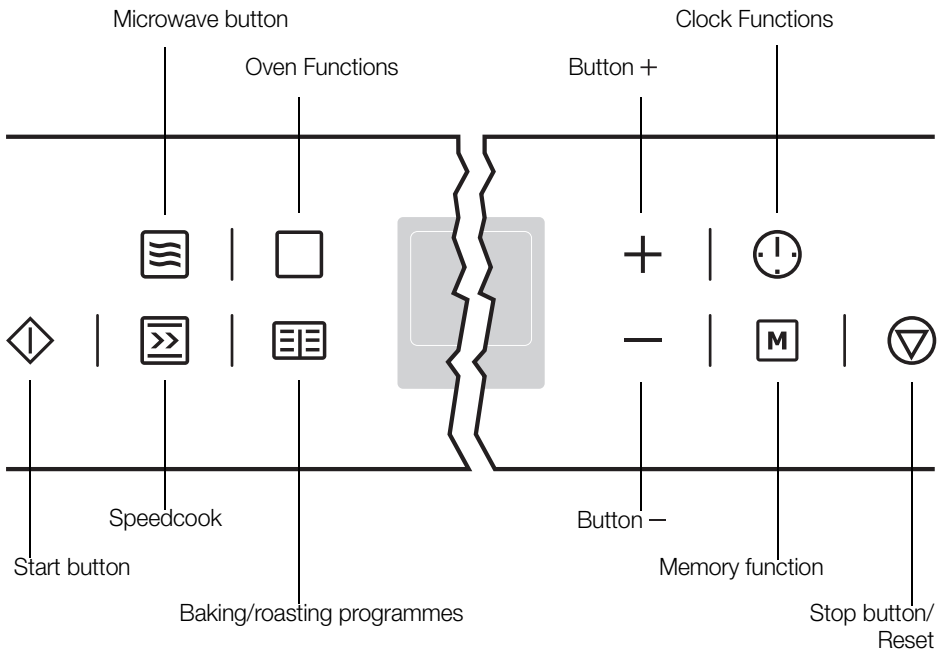

The display field



The control panel



General instructions

- Always confirm the selected function with the Start  button. If the selected function is not started within 120 seconds, the appliance switches itself off.
- When the selected function is started, the oven begins to heat up or the time set begins to count down.
- If the oven door is opened during operation, the function stops. After closing the door continue with the Start  button. If the Start  button is not pressed within 120 seconds, the appliance switches off.
- The oven light is switched on as long as an oven function is started or the oven door is open. The oven light goes off after 10 minutes when the door is open and the appliance switched off.
- Stop operation with the Stop  button, continue with the Start  button. Switch the appliance off by pressing the Stop  button again.

Selecting oven function

1. Press the Oven Functions  button repeatedly until the desired oven function appears.

 - A suggested temperature appears in the temperature display.

2. Press the Start  button to start the function that has been set.

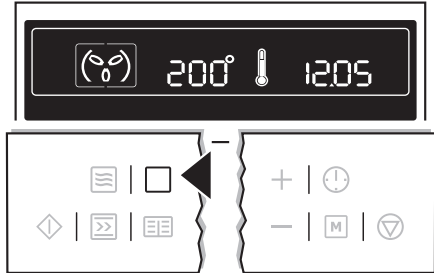



Changing the oven temperature

Press the + or – button, to raise or lower the temperature.

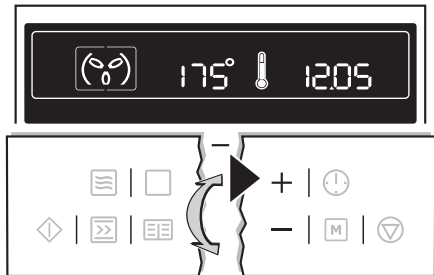
The setting changes in 5 °C steps.



Thermometer symbol

- The slowly rising thermometer symbol  indicates how far the oven has heated up.
- The three segments of the thermometer symbol  flashing one after the other show that Fast Warm Up is on.

Switching the oven off

To switch the oven off, press the Stop  button repeatedly until only the time and any residual heat is displayed.



Cooling fan



The fan switches on automatically in order to keep the appliance's surfaces cool. When the oven is switched off, the fan continues to run to cool the appliance down, then switches itself off automatically.

Speedcook

After an oven function has been selected, using the additional function Speedcook  the empty oven can be pre-heated in a relatively short time.



Important!: Do not put the food to be cooked into the oven, until Speedcook is completed and the oven is operating using the desired function.

1. Set and start the desired oven function (e.g. Convection with ring heating element ). If necessary, change the suggested temperature.
2. Press the Speedcook  button.
The symbol  lights up.



When the bars flash one after another it shows that Speedcook is operating.

When the temperature set is reached, the bars of the heat indicator are lit. An acoustic signal sounds. The symbol  goes out.

The oven now continues heating according to the pre-set oven function and temperature. You can now place the food in the oven.

Oven Functions

The oven has the following functions:

Oven function	Application	Heating element/ fan
 Convection with ring heating element	For roasting and baking on up to two oven levels at the same time.	Rear heating element, fan
 Convection grilling	For roasting larger joints of meat or poultry on one level. This function is also suitable for gratinées and browning dishes on top.	Grill, fan
 Grill	For grilling flat foodstuffs and for toasting.	Grill
 Drying/Defrost	For defrosting and zum drying herbs, fruit or vegetables.	Rear heating element, fan

Microwave

In microwave mode, the heat is created directly in the food. For heating ready meals and drinks, for defrosting meat or fruit and for cooking vegetables and fish.

Combi Function





For the style of heating for the oven function(s), the function **Microwave**  can be switched on. The dishes are cooked in the shortest time and browned at the same time.

Microwave Quick Start

Quick Start of the maximum microwave power when the appliance is switched off using the Start  button.



Operating time from 30 seconds to 7 minutes. Each press of the button adds 30 seconds to the operating time displayed.

Microwave

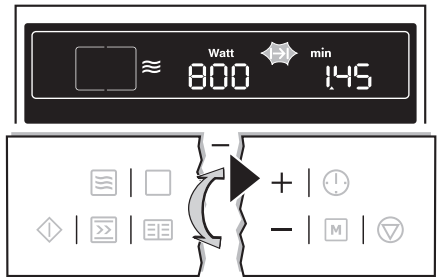
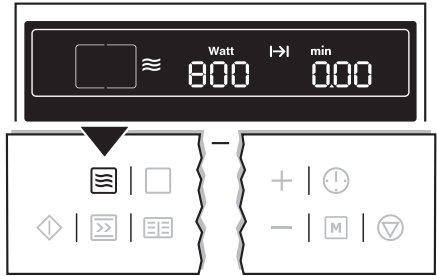
1. If necessary, switch off the appliance using the Stop  button.
2. By repeatedly pressing the Microwave  button, set the desired microwave power.
 - The settings options are in 100 Watt steps from 1,000 Watt to 100 Watt.
 - Repeatedly pressing the Microwave  button makes the power display begin again at 1,000 Watt.
3. Using the + or – button set the desired cook time. The symbol for Cook time  flashes.



- The cooking times can be set as follows:
 - from 0 to 2 mins. in 5 second steps,
 - from 2 to 5 mins. in 10 second steps,
 - from 5 to 10 mins. in 20 second steps,
 - from 10 to 20 mins. in 30 second steps,
 - from 20 mins. onwards in 1 minute steps.
- The maximum length of operation that can be set is:
 - At 700 Watt to 1,000 Watt 0 to 7 minutes 40 seconds,
 - at 100 Watt to 600 Watt 0 to 59 minutes.

4. When the Start  button is pressed, the time set begins to count down. The symbol for Cook time  lights up.
- While the time counts down, the power can be changed using the Microwave  button.

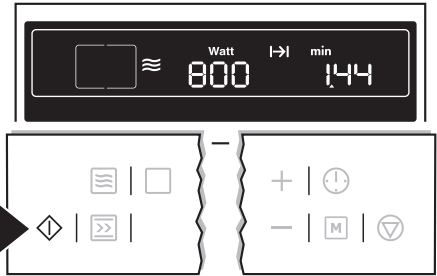

- While the time counts down, using the Clock Functions  and + buttons the cooking time can be increased or — reduced.



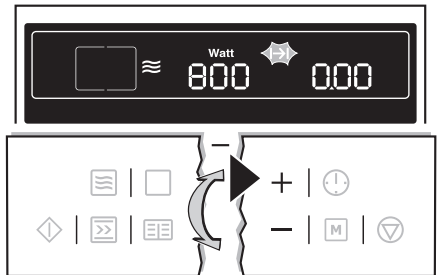

When the time has elapsed, an acoustic signal sounds for 2 minutes. The microwave switches itself off. The symbol for Cook time  flashes and the time display appears.

To turn off the acoustic signal:
Press any button.



Combi Function



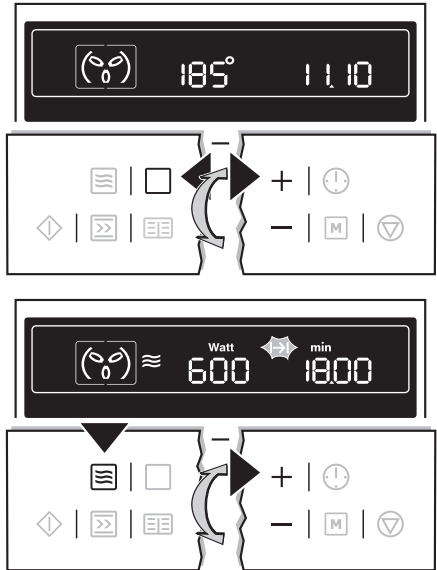

You will find a selection of dishes in the chapter Uses, Tables and Tips: Combi Function.

1. If necessary, switch off the appliance using the Stop  button.
2. Press the Oven Functions  button repeatedly until the desired oven function appears.
3. Using the + or – button set the desired core temperature.
4. By repeatedly pressing the Microwave  button, set the desired microwave power (max. 600 Watt).
5. Using the + or – button set the desired cooking time. The symbol for Cook time  flashes.



- The cooking times can be set as follows:
 - from 0 to 2 mins. in 5 second steps,
 - from 2 to 5 mins. in 10 second steps,
 - from 5 to 10 mins. in 20 second steps,
 - from 10 to 20 mins. in 30 second steps,
 - from 20 mins. onwards in 1 minute steps.

The maximum length of operation that can be set is 59 mins.

6. When the Start  button is pressed, the time set begins to count down. Oven and microwave are on. The symbol for Cook time  lights up.
 - While the time counts down, the power can be changed using the Microwave  button.
 - While the time counts down, using the  and + buttons the cooking time can be increased or – reduced.

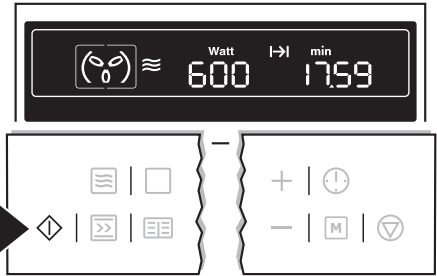





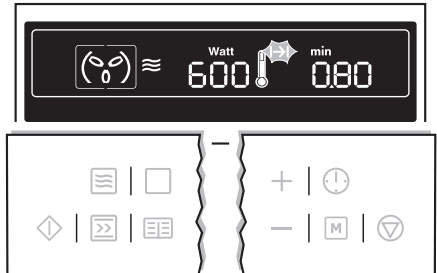

When the time has elapsed, an acoustic signal sounds for 2 minutes. The appliance switches itself off. The symbol for Cook time  flashes and the clock display appears.

To turn off the acoustic signal:
Press any button.



Microwave Quick Start

1. If necessary, switch off the appliance using the Stop  button.
2. Press the Start  button repeatedly until the desired period of operation appears. The appliance switches itself on at maximum microwave power.
 - Each press of the button adds 30 seconds to the period displayed. Maximum of 7 mins. with maximum microwave power.
 - While the time counts down, using the Clock Functions  and + buttons the cooking time can be increased or — reduced.
 - By repeatedly pressing the Microwave  button, the microwave power can be changed.
 - By pressing the Stop  button once, operation can be interrupted. Continue operation using the Start  button. Pressing the Stop  button twice switches the appliance off.

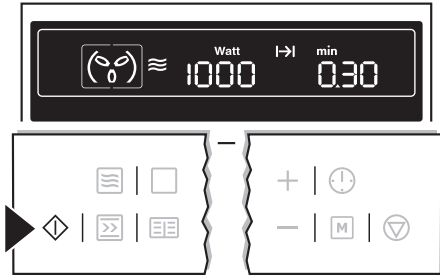

When the time has elapsed, an acoustic signal sounds for 2 minutes. The appliance switches itself off. The symbol for Cook time  flashes and the clock display appears.

To turn off the acoustic signal:
Press any button.

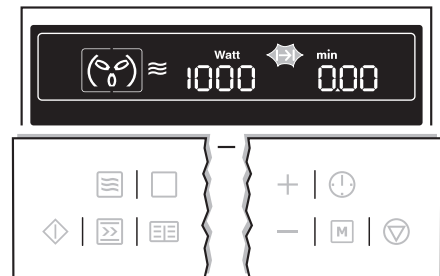

Information on power settings

The overview indicates at which power setting certain processes can be performed. The powers given are guidelines.

Microwave power	Suitable for
1,000 Watt 900 Watt 800 Watt 700 Watt	<ul style="list-style-type: none"> - Heating liquids - Searing at the beginning of a cooking process - Cooking vegetables - Cooking foodstuffs - Melting gelatine and butter
600 Watt 500 Watt	<ul style="list-style-type: none"> - Defrosting and heating frozen meals - Heating one-plate meals - Simmering stews - Cooking egg dishes
400 Watt 300 Watt 200 Watt	<ul style="list-style-type: none"> - Continuing to cook meals - Cooking delicate foodstuffs - Heating baby food - Simmering rice - Heating delicate foods - Melting cheese
100 Watt	<ul style="list-style-type: none"> - Defrosting meat, fish, bread - Defrosting cheese, cream, butter - Defrosting fruit and cakes (gateaux) - Raising yeast dough - Warming up cold dishes and drinks

Inserting the Oven Shelf and the Baking Tray



Shelf runner safety and anti-tip device

As a shelf runner safety device, all insertable components have a small curved indentation at the bottom on the right and left-hand edge.

Always insert insertable components so that this indentation is at the back of the oven interior. This indentation is also important for preventing the insertable components from tipping.

Inserting the baking tray

Push the baking tray between the guide bars of the selected oven level.

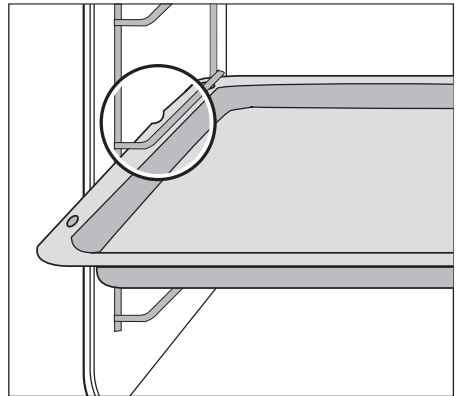

Inserting the oven shelf:

Insert the oven shelf so that the feet point downwards.

Push the oven shelf between the guide bars of the selected oven level.



The high rim around the oven shelf is an additional device to prevent cookware from slipping.

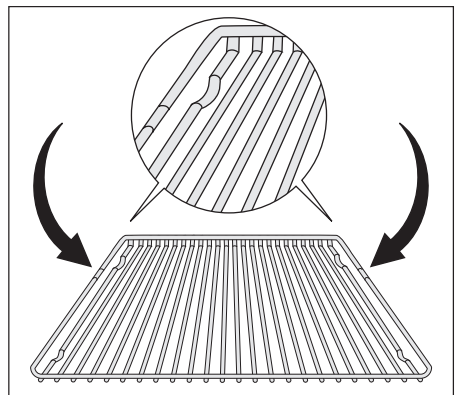

Additional functions

Microwave Programmes



For this function, use the pre-set programmes (see chapter Uses, Tables and Tips: Programmes).

Selecting the programme

1. If necessary, switch off the appliance using the Stop button.
2. Press the Recipes button repeatedly, until the desired programme (P 1 to P12) appears in the display.
 - In the display the preset weight “gr” is displayed. The symbol for Cook time flashes. **Weight = Cook time**

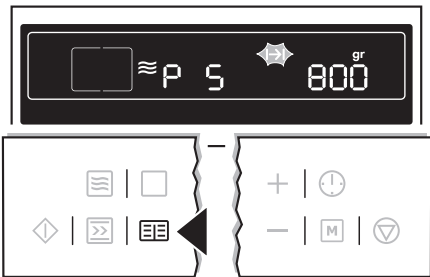

3. By pressing the + or – button, the weight display can be adapted to the weight of the food, minimum 100 g, maximum 1500 g (P 5 to P12 maximum 1000 g).
 - Inputting the weight automatically controls the length of time the microwave operates.
 - Always input the lower weight, e. g. a loaf weighs 460 g: Set the weight to 400 g.

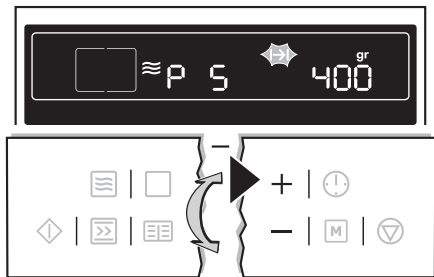

4. When the Start button is pressed, the time set begins to count down. The symbol for Cook time and “min” light up.
 - When the time has elapsed, an acoustic signal sounds for 2 minutes. The microwave switches itself off. The symbol for Cook time flashes.

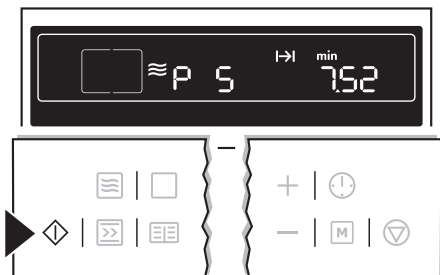



With some programmes, after the time has elapsed a Keep Warm function is started. A signal sounds and in the display “HH” lights up.





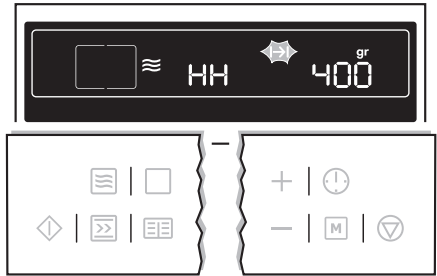

After the Keep Warm function has ended, the signal sounds for 2 minutes. The microwave switches itself off. The symbol for Cook time  flashes and the display for the clock appears.

To turn off the acoustic signal:
Press any button.



Memory Function

The Memory Function can be used to save **one** setting which is used very frequently.

1. Set oven function, temperature and, if necessary, the clock functions Cook time  and/or End time , or set microwave power and Cook time .
2. Press and hold the Memory Function button  for approx. 2 seconds, until an acoustic signal sounds. The setting is saved.
3. Continue by pressing the Start  button or switch the appliance off using the Stop  button.



To save another setting, press the Memory Function button  again for approx. 2 seconds. The previously saved setting is replaced by this one.

Starting the Memory Function

1. If necessary, switch off the appliance using the Stop  button.
2. Using the Memory Function  button call up the saved setting.
3. Press the Start  button.

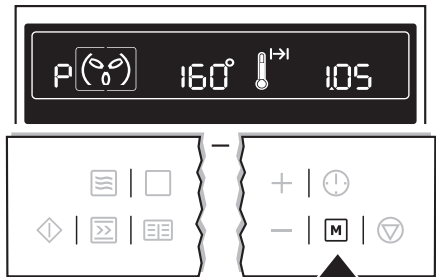
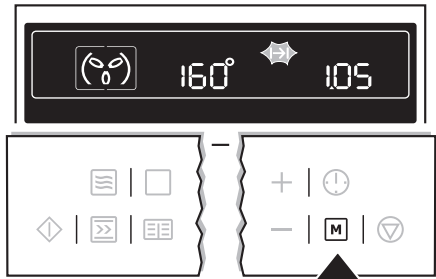

Clock Functions

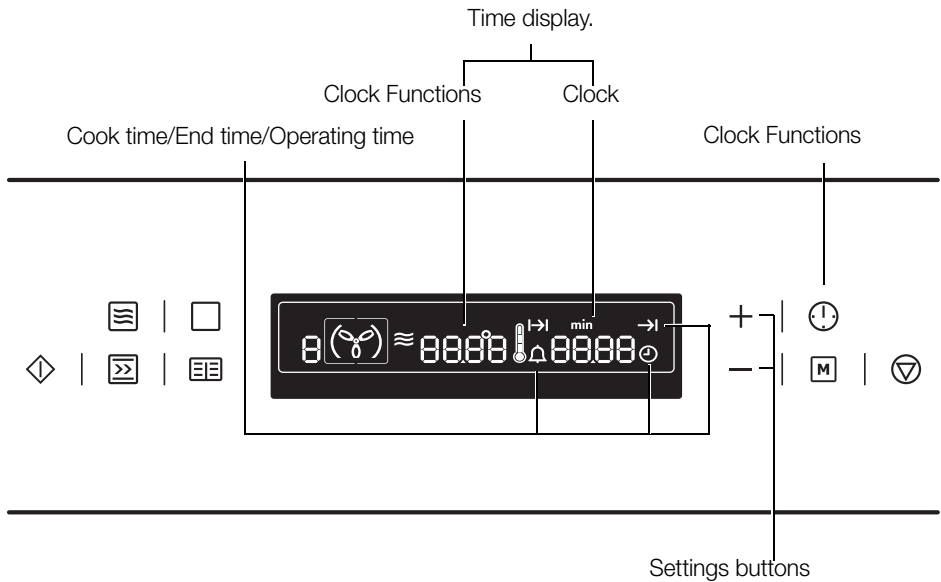

Countdown

To set a countdown. When it has counted down, an audible signal sounds. This function has no effect on the operation of the microwave and oven.

Microwave cook time min

For setting how long the oven is to operate.

Cook time

To set how long the oven is to be in use.

End time



To set when the oven is to switch off again.

Time



To set, change or check the time (See also section “Before Using for the First Time”).



General instructions

- After a clock function has been selected, the corresponding symbol flashes for about 5 seconds. During this time, the desired times can be set or modified using the + or – button.
- When the desired time has been set, the symbol continues to flash for approx. 5 seconds. After this the symbol lights up. The set Countdown  begins to count down.
- The time set for Cook time  and End time  begins to count down after the selected function starts.

Countdown

1. Press the Clock Functions  button repeatedly until the symbol for Countdown  flashes.

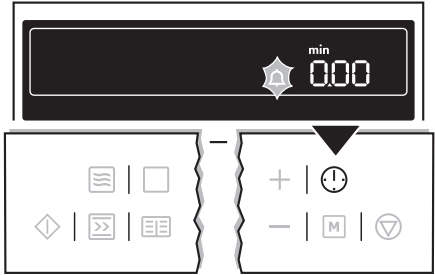

2. Using the +/- button, set the desired countdown (max. 99.00 minutes).

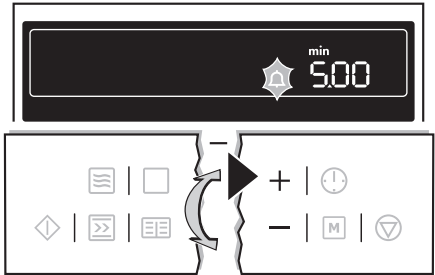

After about 5 seconds the display shows the time remaining. The symbol for Countdown  lights up.

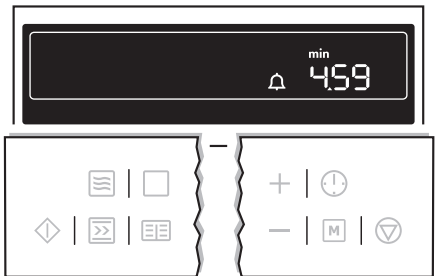



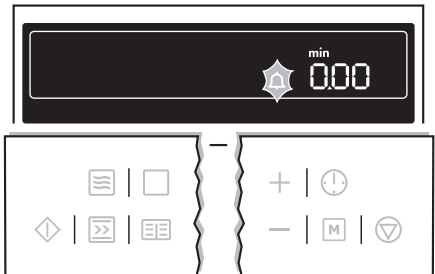

When the time set has elapsed, an acoustic signal sounds for 2 minutes. "0.00" lights up and the symbol for Countdown  flashes.





To turn off the acoustic signal: Press any button.

Microwave cook time min

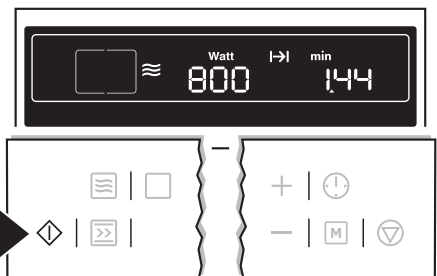
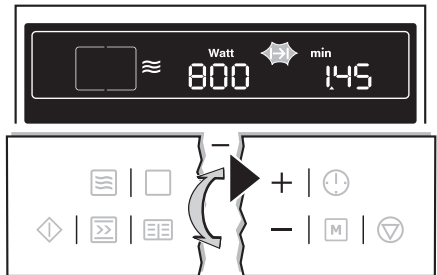
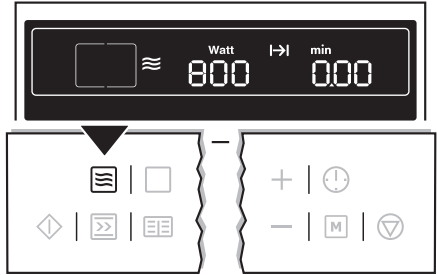
1. Select microwave function and set the power by repeatedly pressing the Microwave  button.
2. Using the + or – button, set the desired cooking time. The symbol for Cook time  flashes.
3. When the Start  button is pressed, the time set begins to count down. The symbol for Cook time  lights up.



By repeatedly pressing the Clock Functions  button, the current time can be called up.
While the time counts down, using the  and + buttons the cook time can be increased or – reduced.



When the time has elapsed, an acoustic signal sounds for 2 minutes. The microwave switches itself off.

“0.00” is displayed and the symbol for Cook time  flashes.

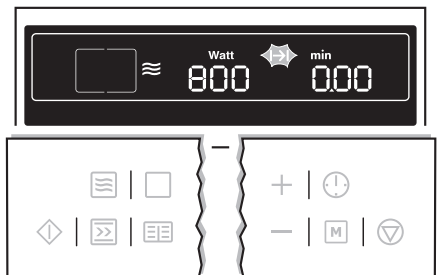
To turn off the acoustic signal:
Press any button.



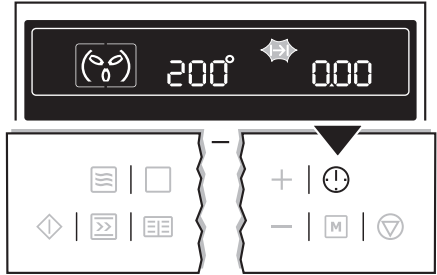

Cook time

1. Select oven function and temperature using the + or – button.
2. Press the Clock Functions  button repeatedly until the symbol for Cook time  flashes.

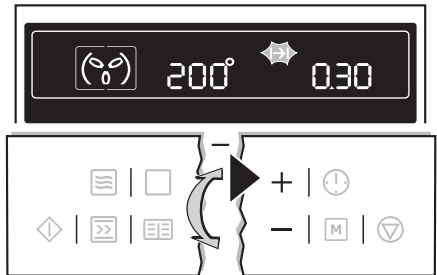

3. Using the + or – button, set the desired cooking time.



4. When the Start  button is pressed, the time set begins to count down. The symbol for Cook time  lights up.

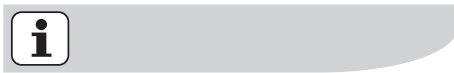
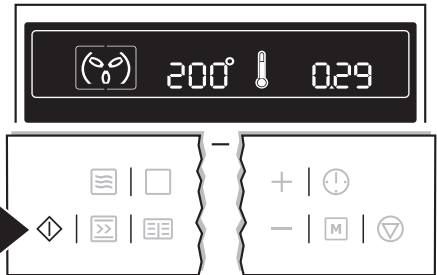

By repeatedly pressing the Clock Functions  button, the current time can be called up.



When the time has elapsed, an acoustic signal sounds for 2 minutes. The oven switches itself off.

“0.00” is displayed and the symbol for Cook time  flashes.

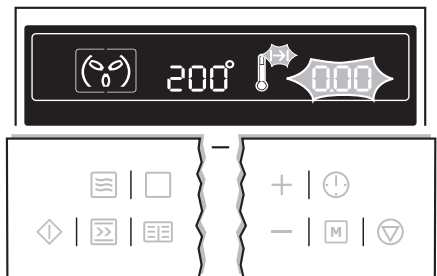
To turn off the acoustic signal:
Press any button.



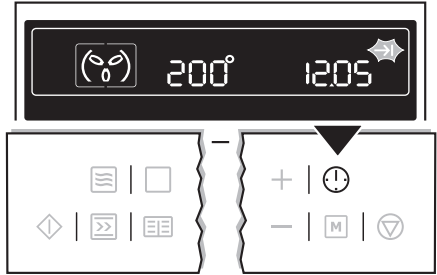

End time 

1. Select oven function and temperature using the + or – button.
2. Press the Clock Functions  button repeatedly until the symbol for End time  flashes.

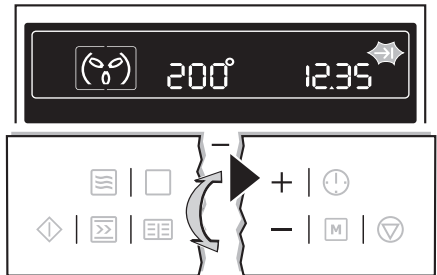

3. Using the + or – button, set the desired switch-off time.



The symbols for End time  and Cook time  light up. The oven switches itself off automatically.

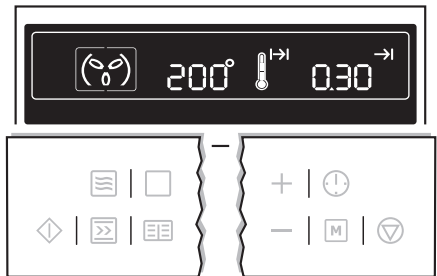

By repeatedly pressing the Clock Functions  button, the current time can be called up.

When the time has elapsed, an acoustic signal sounds for 2 minutes. The oven switches itself off.



“0.00” is displayed and the symbols for End time  and Cook time  flash.

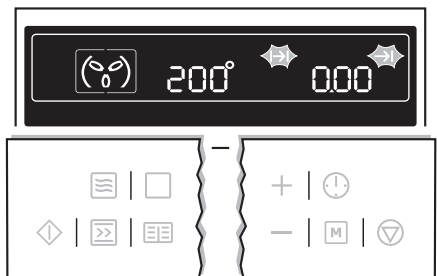

To turn off the acoustic signal:
Press any button.





Cook time and End time combined

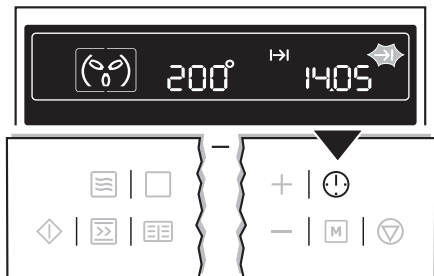
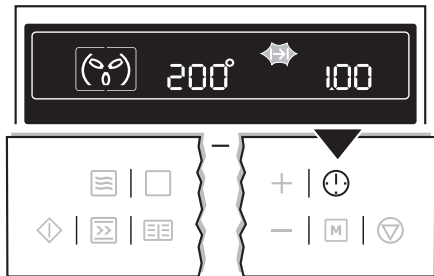

Cook time  and End time  can be used simultaneously, if the oven is to be switched on and off automatically at a later time.

1. Select oven function and temperature.
2. Using the Cook time  function, set the time required for cooking the dish.
e.g. 1 hour.
3. Using the End time  function, set the time at which the dish is to be ready.
e.g. at 14:05.



The symbols for Cook time  and End time  light up.
The oven switches on automatically at the time calculated.
e.g. at 13:05.

When the set cooking time has elapsed, an acoustic signal sounds for 2 minutes and the oven switches itself off.
e.g. at 14:05.

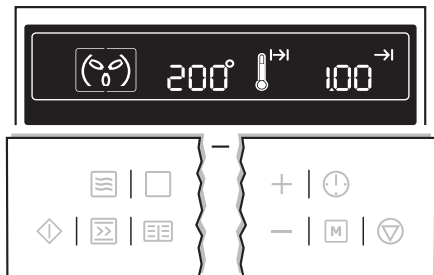



Other Functions

Switching off the display



You can save energy by switching off the display.

Switching off the display



1. If necessary, **switch off** the appliance using the Stop  button. Residual heat must not be displayed.
2. Press the Clock Functions  and the — buttons at the same time until the display goes out.



As soon as the appliance is switched on again, the display automatically switches itself on. When the appliance is next switched off, the clock display goes out again.

To have the time permanently displayed again, you must switch the display on again.

Switching on the display

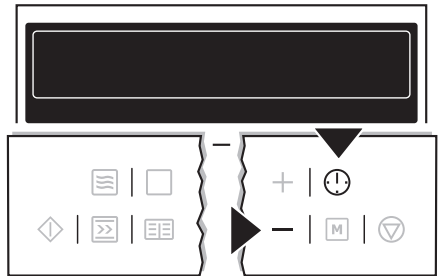

1. If necessary, **switch off** the appliance using the Stop  button.
2. Press the Clock Functions  and the — buttons at the same time until the display appears again.



Child safety device

As soon as the child safety device is activated, it is no longer possible to operate the oven.

Activating the child safety device

1. If necessary, **switch off** the appliance using the Stop  button.
An oven function must not be selected.
 2. Press Recipes  and **−** buttons at the same time until **SAFE** appears in the display.
- The child safety device is now operating.



Deactivating the child safety device

1. If necessary, switch off appliance using the Stop  button.
 2. Press Recipes  and **−** buttons at the same time until **SAFE** goes out in the display.
- The child safety device is now deactivated and the oven is again ready for use.

Button beep

Switching off button beep

1. If necessary, **switch off** appliance using the Stop  button.
 2. Press and hold **+** and **−** buttons at the same time until a signal sounds (approx. 2 seconds).
- The button beep is now switched off.



Switching on button beep

Press and hold **+** and **−** buttons at the same time until a signal sounds (approx. 2 seconds).

The button beep is switched on again.

Oven safety cut-out



If not switched off after a certain time, or if the temperature is not modified, the oven switches off automatically.

The last temperature set flashes in the temperature display.

The oven switches itself off at an oven temperature of:

30 - 120°C	after	12.5 hours
120 - 200°C	after	8.5 hours
200 - 250°C	after	5.5 hours

OFF appears in the display.

Using the appliance after a safety cut-out

Switch the oven off completely.

It can then be switched on again.

Uses, Tables and Tips

Baking

Oven Function: Convection with ring heating element

Baking tins

- For Convection with ring heating element  light metal tins are suitable.

Oven levels

- With Convection with ring heating element  you can bake on up to 2 baking trays at the same time:

1 baking tray:
e.g. oven level 2

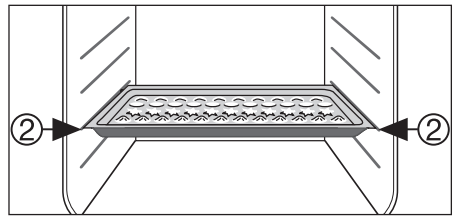

1 baking tin:
e.g. oven level 1

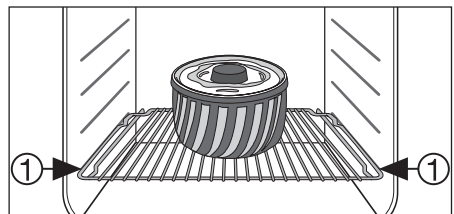

2 baking trays:
e.g. oven levels 1 and 3

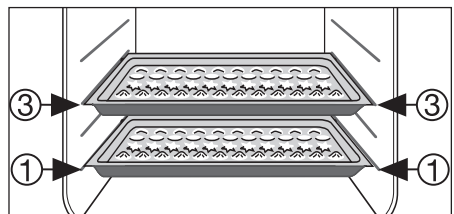

General instructions

With Convection with ring heating element (🔥) you can also bake two cakes at the same time in tins placed next to each other on the shelf. This does not significantly increase baking time.



When frozen foods are used the trays inserted may distort during cooking. This is due to the large difference in temperature between the freezing temperature and the temperature in the oven. Once the trays have cooled the distortion will disappear again.

How to use the Baking Tables

The tables give the required temperature settings, baking times and oven shelf levels for a selection of typical dishes.

- Temperatures and baking times are for guidance only, as these will depend on the consistency of pastry, mixture or dough, the number and the type of baking tin.
- We recommend setting the lower temperature when baking for the first time, and if required, e.g. if a darker browning is desired or if the baking time is too long, select a higher temperature.
- If you cannot find the settings for a particular recipe, look for the one that is most similar.
- If baking cakes on baking trays or tins on more than one level, baking time can be extended by 10-15 minutes.
- Moist recipes (for example, pizzas, fruit flans, etc.) are baked on one level.

- Cakes and pastries at different heights may brown at an uneven rate at first. If this occurs, **please do not change the temperature setting.** Different rates of browning even out as baking progresses.
- Your new oven may bake or roast differently to your previous appliance. So adapt your normal settings (temperature, cooking times) and oven shelf levels to the recommendations in the following tables.





With longer baking times, you can switch the oven off about 10 minutes before the end of the baking time, in order to utilise the residual heat.

Unless otherwise stated, the values given in the tables assume that cooking is started with the oven cold.

Baking table

Baking on one oven level

Type of baking	Convection with ring heating element 		
	Oven level	Temperature °C	Time Hrs: Mins.
Baking in tins			
Ring cake or brioche	1	160-170	0:50-1:10
Madeira cake/Fruitcake	1	150-170	1:10-1:30
Sponge cake	1	160-180	0:25-0:40
Flan base - shortcrust pastry	2	170-190	0:10-0:25
Flan base - sponge mixture	2	150-170	0:20-0:25
Covered apple tart	1	160-180	0:50-1:00
Apple pie (2 tins Ø 20cm, diagonally off set)	1	180-190	1:05-1:20
Savoury flan (e. g. quiche lorraine)	2	170-190	0:30-1:10
Cheesecake	1	160-180	1:00-1:30
Cakes/pastries/breads on baking trays			
Plaited bread/bread crown	1	160-180	0:30-0:40
Christmas stollen	1	160-180	0:40-1:00
Bread (rye bread)	1	180-200	0:45-0:60
Cream puffs/eclairs	2	170-190	0:30-0:40
Swiss roll	2	200-220 ¹⁾	0:08-0:15
Cake with crumble topping(dry)	2	160-180	0:20-0:40
Buttered almond cake/sugar cakes	2	170-190 ¹⁾	0:15-0:30
Fruit flan (made with yeast dough/sponge mixture)	2	160-180	0:25-0:50
Fruit flans made with shortcrust pastry	2	170-190	0:40-1:20
Yeast cakes with delicate toppings (e. g. quark, cream, vanilla cream)	2	150-170	0:40-1:20
Pizza (with a lot of topping)	2	190-210 ¹⁾	0:20-0:40
Pizza (thin crust)	2	230 ¹⁾	0:12-0:20
Unleavened bread	2	230 ¹⁾	0:10-0:20
Swiss flaky pastry tarts	2	190-210	0:35-0:50

Type of baking	Convection with ring heating element 		
	Oven level	Temperature °C	Time Hrs: Mins.
Biscuits			
Short pastry biscuits	2	160-180	0:06-0:20
Viennese whirls	2	160	0:10-0:40
Biscuits made with sponge mixture	2	160-180	0:15-0:20
Pastries made with egg white, meringues	2	80-100	2:00-2:30
Macaroons	2	100-120	0:30-0:60
Biscuits made with yeast dough	2	160-180	0:20-0:40
Puff pastries	2	180-200 ¹⁾	0:20-0:30
Bread rolls	2	210-230	0:20-0:35
Small cakes (20 per tray)	2	170 ¹⁾	0:20-0:30

1) Pre-heat oven

Baking on more than one oven level

Type of baking	Convection with ring heating element 		Time Hrs: Mins.
	Oven level from the bottom	Temperature in °C	
Biscuits			
Short pastry biscuits	1 / 3	160-180	0:15-0:35
Viennese whirls	1 / 3	180	0:20-0:60
Biscuits made with sponge mixture	1 / 3	160-180	0:25-0:40
Pastries made with egg white, meringues	1 / 3	80-100	2:10-2:50
Macaroons	1 / 3	100-120	0:40-1:20
Danish pastries	1 / 3	160-180	0:30-0:60
Puff pastries	1 / 3	180-200 ¹⁾	0:30-0:50

1) Pre-heat oven

Tips on baking





Baking results	Possible cause	Remedy
The cake is not browned enough at the bottom	Wrong oven level	Place cake lower in the oven
The cake sinks (becomes soggy, lumpy, streaky)	Oven temperature too high	Use a slightly lower setting
	Baking time too short	Set a longer baking time Baking times cannot be reduced by setting higher temperatures
	Too much liquid in the mixture	Use less liquid Pay attention to mixing times, especially if using mixing machines
Cake is too dry	Oven temperature too low	Set oven temperature higher
	Baking time too long	Set a shorter baking time
Cake browns unevenly	Oven temperature too high and baking time too short	Set a lower oven temperature and a longer baking time
	Mixture is unevenly distributed	Spread the mixture evenly on the baking tray
Cake is not done within the baking time given	Temperature too low	Use a slightly higher oven setting

Table Bakes and Gratins

Dish	Convection with ring heating element 		
	Oven level	Temperature °C	Time Hrs: Mins.
Pasta bake	1	180-200	0:45-1:00
Lasagne	1	180-200	0:25-0:40
Vegetables au gratin ¹⁾	1	160-170	0:15-0:30
Gratinated baguettes ¹⁾	1	160-170	0:15-0:30
Sweet bakes	1	180-200	0:40-0:60
Fish bakes	1	180-200	0:30-1:00
Stuffed vegetables	1	160-170	0:30-1:00

1) Pre-heat oven

Table Frozen Ready Meals Table

Food to be cooked	Oven function:	Oven level	Temperature °C	Time
Frozen pizza	 Convection with ring heating element	3	as per manufacturer's instructions	as per manufacturer's instructions
Chips ¹⁾ (300-600 g)	 Convection grilling	3	200-220	as per manufacturer's instructions
Baguettes	 Convection with ring heating element	3	as per manufacturer's instructions	as per manufacturer's instructions
Fruit flan	 Convection with ring heating element	3	as per manufacturer's instructions	as per manufacturer's instructions

1) Note: Turn chips 2 or 3 times during cooking

Roasting

Oven function: Convection with ring heating element

Ovenware for roasting

- Any heat-resistant ovenware is suitable to use for roasting. (Please read the manufacturer's instructions.)
- For all lean meats, we recommend **roasting these in a roasting tin or dish with a lid**. The meat will be more succulent.
- All types of meat, that can be browned or have crackling, can be roasted in a **roasting tin or dish without a lid**.



Tips on using the Roasting Table

The information given in the following table is for guidance only.

- We recommend cooking meat and fish **weighing 1kg or more** in the oven.
- To prevent meat juices or fat from burning onto the ovenware, we recommend adding some liquid.
- If required, turn the roast (after 1/2 - 2/3 of the cooking time).
- Baste large roasts and poultry with their juices several times during roasting. This will give better roasting results.
- You can switch the oven off about 10 minutes before the end of the roasting time, in order to utilise the residual heat.

Roasting table

Food to be roasted	Convection with ring heating element 		
	Oven level	Temperature °C	Time Hours: Mins.
Pork			
Shoulder, neck, ham joint (1,000-1,500 g)	1	170-190	1:30-2:00
Chops, Kasseler (smoked loin of pork) (1,000-1,500 g)	1	180-200	1:00-1:30
Meat loaf (750-1,000 g)	1	180-200	0:45-1:00
Knuckle of pork (pre-cooked) (750-1,000 g)	1	170-190	1:30-2:00
Beef			
Pot roast (1,000-1,500 g)	1	180-200	2:00-2:30
Roast beef or filet, per cm of thickness	1	210-230*	0:06-0:09 per cm of thickness
Veal			
Roast veal, 1,000 g	1	170-190	1:30-2:00
Knuckle of veal (1,500-2,000 g)	1	170-190	2:00-2:30
Lamb			
Leg of lamb (1,000-1,500 g)	1	170-190	1:15-2:00
Saddle of lamb (1,000-1,500 g)	1	180-200	1:00-1:30
Quick roast items cooked on a baking tray			
Sausages 'cordon bleu'	1	220-230*	0:05-0:08
Small sausages	1	220-230*	0:12-0:15
Schnitzel or chops, crumbed	1	220-230*	0:15-0:20
Rissoles	1	210-220*	0:15-0:20
Fish (steamed)			
Whole fish (1,000-1,500 g)	1	210-220	0:45-1:15
Poultry			
Chicken, poulard (1-1.5 kg)	1	190-210	0:45-1:15
Chicken halves, (400-500 g each)	1	200-220	0:35-0:50
Chicken pieces (200-250 g each)	1	200-220	0:35-0:50
Duck (1,500-2,000 g)	1	180-200	1:15-1:45

Food to be roasted	Convection with ring heating element 		
	Oven level	Temperature °C	Time Hours: Mins.
Game			
Saddle of hare, leg of hare (up to 1,000 g)	1	220-230*	0:25-0:40
Saddle of venison (1,500-2,000 g)	1	210-220	1:15-1:45
Leg of venison (1,500-2,000 g)	1	200-210	1:30-2:15

* Preheat oven

Grill

Oven function: Grill  with maximum temperature setting



Important: Always grill with the oven door closed.

- For grilling, use both the shelf and the tray together.
- The grilling times are guidelines.
- Grilling is particularly suitable for flat pieces of meat or fish.

Grilling table

Food to be grilled	Oven level	Grilling time	
		1st side	2nd side
Rissoles	3	8-10 mins.	6-8 mins.
Pork fillet	2	10-12 mins.	6-10 mins.
Sausages	3	8-10 mins.	6-8 mins.
Fillet steaks, veal steaks	3	6-7 mins.	5-6 mins.
Fillet of beef, roast beef (approx. 1 kg)	2	10-12 mins.	10-12 mins.
Toast ¹⁾	3	4-6 mins.	3-5 mins.
Toast with topping	2	8-10 mins.	---

1) Use the grill shelf without a tray

Convection grilling

Oven function: Convection grilling 

Dish	Temperature in °C	Tray	Grill shelf	Grilling time in minutes	Turn after ... minutes
		Oven level			
Chicken (900-1,000 g)	180-200	1	2	50-60	25-30
Stuffed rolled pork roast (2,000 g)	180-200	1	2	90-95	45
Pasta bake	180	---	2	30	---
Gratinated potato bake	200	---	2	20-23	---
Gnocchi gratin	180	---	2	20-23	---
Cauliflower with Hollandaise sauce	200	---	2	15	---

Defrosting

Oven function: **Drying/Defrost** **(30°C temperature setting)**

- Unwrap the food and place it on a plate on the oven shelf.
- Do not cover with a plate or bowl, as these can substantially lengthen the defrosting time.
- For defrosting, place the shelf in the **1st oven level from the bottom.**

Defrosting table

Dish	Defrosting time mins.	Further defrosting time (mins.)	Comments
Chicken, 1000 g	100-140	20-30	Place the chicken on an upturned saucer placed on a large plate Turn halfway through
Meat, 1000 g	100-140	20-30	Turn halfway through
Meat, 500 g	90-120	20-30	Turn halfway through
Trout, 150g	25-35	10-15	---
Strawberries, 300g	30-40	10-20	---
Butter, 250g	30-40	10-15	---
Cream, 2 x 200g	80-100	10-15	Cream can also be whipped when still slightly frozen in places
Gateau, 1400g	60	60	---

Drying

Oven function: **Drying/Defrost**

- Use trays covered with greaseproof paper or baking parchment.
- You will get a better result if you switch the oven off halfway through the drying time, open the door and leave to cool down, preferably overnight.
- Then finish drying the food to be dried.

Food to be dried	Temperature in °C	Oven level		Time in hours (guideline)
		1 level	2 levels	
Vegetables				
Beans	75	2	1 / 3	6-9
Peppers (slices)	75	2	1 / 3	5-8
Vegetables for soup	75	2	1 / 3	5-6
Mushrooms	50	2	1 / 3	6-9
Herbs	40-50	2	1 / 3	2-4
Fruit				
Plums	75	2	1 / 3	8-12
Apricots	75	2	1 / 3	8-12
Apple slices	75	2	1 / 3	6-9
Pears	75	2	1 / 3	9-13

Making preserves

Oven function: Convection with ring heating element

- When making preserves, only use commercially available preserve jars of the same size.
- **Jars with twist-off or bayonet type lids and metal tins are not suitable.**
- When making preserves, use the **first shelf position from the bottom.**
- Use the baking tray for making preserves. There is enough room on this for up to six 1-litre preserving jars.
- The jars should all be filled to the same level and clamped shut.
- Place the jars on the baking tray in such a way that they are not touching each other.
- Pour approx. 1/2 litre of water into the baking tray so that sufficient moisture is produced in the oven.
- As soon as the liquid in the first jars begins to simmer (with 1--litre jars after about 35-60 minutes), switch off the oven or reduce the temperature to 100°C. (See table.)

Preserves table

The times and temperatures for making preserves are for guidance only.

Preserve	Temperature in °C	Cooking time until simmering in mins.	Continue to cook at 100 °C in mins.
Soft fruit			
Strawberries, blueberries, raspberries, ripe gooseberries	160-170	35-45	---
Unripe gooseberries	160-170	35-45	10-15
Stone fruit			
Pears, quinces, plums	160-170	35-45	10-15
Vegetables			
Carrots ¹⁾	160-170	50-60	5-10
Mushrooms ¹⁾	160-170	40-60	10-15
Cucumbers	160-170	50-60	---
Mixed pickles	160-170	50-60	15
Kohlrabi, peas, asparagus	160-170	50-60	15-20
Beans	160-170	50-60	---

1) Leave standing in oven when switched off

Microwave

Information about operation

General

- After switching off the appliance, let the food stand for a few minutes (see Microwave Tables: Standing Time).
- Remove aluminium foil packaging, metal containers, etc. before preparing the food.

Cooking

- If possible, cook food covered with material suitable for use in the microwave. Only cook food uncovered, if a crust is to be kept.
- Chilled or frozen foods require a longer cooking time.
- Dishes containing sauce should be stirred from time to time.
- Vegetables that have a firm structure, such as carrots, peas or cauliflower, should be cooked in water.
- Turn larger pieces about halfway through the cooking time.
- If possible, cut vegetables into similar sized pieces.
- Use flat, wide dishes.

Defrosting meat, poultry, fish

- Place the frozen, unwrapped food on a small upturned plate with a container underneath or on a defrosting rack or plastic sieve so that the defrosting liquid can run off.
- Turn the food after half the defrosting time. If possible, divide, remove pieces that have started to defrost.

Defrosting butter, portions of gâteau, quark

- Do not defrost completely in the appliance, but leave to defrost at room temperature. This gives a more even result. Remove any metal or aluminium packaging or parts before defrosting completely.



Defrosting fruit, vegetables

- Do not completely defrost fruit and vegetables, which are to be further prepared while still raw, in the appliance, but at room temperature.
- Fruit and vegetables that are to be cooked, can be cooked directly using a higher microwave power, without being defrosted.

Ready Meals

- Ready meals in metal packaging or plastic trays with metal covers may only be defrosted or heated in the microwave if these are expressly designated as suitable for use in the microwave.
- You must follow the manufacturer's instructions printed on the packaging (e. g. remove metal cover and pierce plastic film).

Suitable cookware and materials

Cookware/Material	Microwave 			Oven Grill 
	Defrosting	Heating	Cooking	
Ovenproof glass and porcelain (with no metal components, e. g. Pyrex, heatproof glass)	X	X	X	X
Non-ovenproof glass and porcelain ¹⁾	X	--	--	--
Glass and glass ceramic made of ovenproof/frostproof material (e. g. g. Arcoflam), grill shelf	X	X	X	X
Ceramic ²⁾ , stoneware ²⁾	X	X	X	--
Plastic heat-resistant to 200°C ³⁾	X	X	X	--
Cardboard, paper	X	--	--	--
Clingfilm	X	--	--	--
Roasting film with microwave safe closure ³⁾	X	X	X	--
Roasting dishes made of metal, e.g. enamel, cast iron	--	--	--	X
Baking tins, black lacquer or silicon-coated ³⁾	--	--	--	X
Baking tray	--	--	--	X
Browning cookware, e. g. Crostino or Crunch plate	--	X	X	--
Ready meals in packaging ³⁾	X	X	X	X

¹⁾ with no silver, gold, platinum or metal plating/ decorations

²⁾ Without quartz or metal parts, no metallic glaze

³⁾ Please observe the maximum temperatures quoted by the manufacturer.

X is suitable

-- is not suitable



Other things to think about...

- Foods have different shapes and qualities. They are prepared in different amounts. Therefore the necessary times and powers for defrosting, heating or cooking are all different. As a rough guide: **Double the amount = Almost double the time**
- When heating with the microwave the heat is produced in the food itself. For this reason all places cannot be heated at the same time. The heated dishes should therefore be stirred or turned, especially in the case of larger amounts of food.
- The **standing time** is given in the tables. Let the food stand, in the appliance or outside it, so that the heat is distributed more evenly.
- You get better results for rice using flat, wide dishes.

Microwave Cooking Table

Defrost

Dish	Microwave 				Comments
	Size (g)	Power (Watts)	Cook time (Mins.)	Standing time (Mins.)	
Meat					
Meat generally	500	200	10-12	10-15	Turn halfway through cooking
Steaks	200	200	3-5	5-10	Turn halfway through cooking time, remove defrosted parts
Mixed minced meat	500	200	10-15	10-15	
Goulash	500	200	10-15	10-15	
Poultry					
Chicken	1000	200	25-30	10-20	Turn halfway through cooking time, cover defrosted parts with aluminium foil
Chicken breast	100-200	200	3-5	10-15	
Chicken thighs	100-200	200	3-5	10-15	
Duck	2000	200	45-60	20-30	
Fish					
Fish generally	500	100	10-15	15-20	Turn halfway through
Fish fillets	500	100	10-12	15-20	
Sausage					
Sliced sausage	100	100	2-4	20-40	Turn halfway through
Dairy products					
Quark	250	100	10-15	25-30	Remove aluminium parts, turn halfway through
Butter	250	100	3-5	15-20	
Cheese	250	100	3-5	30-60	
Cream	200	100	7-12	20-30	Remove aluminium top, stir halfway through
Cakes/Pastries/Bread					
Yeast dough	1	100	2-3	15-20	Turn plate halfway through
Cheesecake	1	100	2-4	15-20	
Cake (gâteau)	1	100	1-2	15-20	

Dish	Microwave 				Comments
	Size (g)	Power (Watts)	Cook time (Mins.)	Standing time (Mins.)	
Dry cake (e. g. pound cake)	1	100	2-4	15-20	Turn plate halfway through
Fruit flan	1	100	1-2	15-20	
Bread	1 kg	100	15-20	10-15	Turn halfway through
Sliced bread	0.5 kg	100	8-12	10-15	
Bread rolls	4 rolls	100	5-8	5-10	
Fruit					
Strawberries	300	100	8-12	10-15	Defrost covered, stir halfway through
Plums, cherries, raspberries, blackcurrants, apricots	250	100	8-10	10-15	
Melting					
Chocolate / Chocolate coating	150	600	2-3	---	Stir halfway through
Butter	100	200	2-4	---	
Heating					
Baby food in jars	200	300	2-3	---	Stir halfway through Check temperature!
Baby milk (180 ml bottle)	200	1000	0:20-0:40	---	Put spoon in the bottle, stir, Check temperature!
Ready meals	400-500	600	4-6	5	Remove any aluminium covers, turn halfway through
Frozen ready meals	400-500	400	14-20	5	
Milk	1 cup approx. 200ml	1000	1:15-1:45	---	Put spoon in the container
Water	1 cup approx. 200ml	1000	1:30-2	---	
Sauce	200 ml	600	1-2	---	Stir halfway through
Soup	300 ml	600	2-4	---	

Microwave Cooking Table

Cooking



















Dish	Microwave 				Comments
	Size (g)	Power (Watts)	Cook time (Mins.)	Standing time (Mins.)	
Fish generally	500	500	8-10	---	Cook covered, turn container several times during cooking
Fish fillets	500	500	6-8	---	
Vegetables, short cooking time, fresh ¹⁾	500	600	12-16	---	
Vegetables, short cooking time, frozen ¹⁾	500	600	14-18	---	Add approx. 50 ml water, cook covered, stir halfway through
Vegetables, long cooking time, fresh ¹⁾	500	600	14-20	---	
Vegetables, long cooking time, frozen ¹⁾	500	600	18-24	---	
Boiled potatoes	800 g + 600 ml	1000	5-7	300 W / 15-20	Cook covered, stir halfway through
Rice	300 g + 600 ml	1000	4-6	---	







¹⁾ Cook all vegetables with a cover on the container. The times given are guidelines only and depend upon the type and qualities of the foodstuffs.

Combi-Function Table

Oven Functions: Convection with ring heating element  +

Microwave  or **Convection grilling**  + **Microwave** 

Dish	Bake-ware/ Roasting dishes	Oven function	Temp . in °C	Microw. Watt	Oven level	Time in mins.	Comments
Bake/Quark bake	Gratin dish on oven shelf	 + 	250	600	1	25-35	
Bake/Gratin	Gratin dish on oven shelf	 + 	250	600	1	30-40	
Duck 2,000 g	Glass dish on oven shelf	 + 	First 250 ¹⁾ then 180	300 300	1	40-60	Turn after 15 mins., then 180°C, 10 mins. standing time
Fish fillets 350 g	Glass dish on oven shelf	 + 	250	600	1	15-20	Stuffed, rolled, seasoned
Fish gratin 1,400 g	Glass dish	 + 	250	300	1	30-40	
Poultry, whole	Glass dish on oven shelf	 + 	200	300	1	30-40	Turn after 20 mins.
Poultry halves	Glass dish on oven shelf	 + 	200	300	1	25-35	Turn after 15 mins.
Meat loaf 650 g	Glass dish on oven shelf	 + 	250	300	1	30-40	5 mins. standing time
Chicken thighs	Glass dish on oven shelf	 + 	250	600	1	20-25	Turn after 20 mins.
Roast veal 1,000 g	Glass dish on oven shelf	 + 	210	300	1	30-40	Turn after 25 mins., uncovered, 5 mins. standing time
Potato gratin	Glass dish on oven shelf	 + 	250	600	1	20-25	Sprinkle with cheese
Leg of lamb with bone in 1,000 g	Glass dish on oven shelf	 + 	180	300	1	30-40	5 mins. standing time

Dish	Bake-ware/ Roasting dishes	Oven function	Temp. in °C	Microw. Watt	Oven level	Time in mins.	Comments
Leg of lamb with no bone 1,000 g	Glass dish on oven shelf	 + 	200	300	1	30-40	5 mins. standing time
Lasagne 1,200 g	Gratin dish on oven shelf	 + 	250	400	1	25-30	
Pasta bake 1,800 g	Gratin dish on oven shelf	 + 	250	400	1	30-35	Stir after 20 mins.
Pepper, stuffed	Glass dish on oven shelf	 + 	250	400	1	20-25	Pepper halves with cheese/vegetable filling
Roast beef 1,000 g	Glass dish on oven shelf	 + 	180	400	1	60-70	10 mins. standing time, turn once, cook covered
Roast neck of pork 1,200 g	Glass dish on oven shelf	 + 	230	400	1	55-65	5 mins. standing time, turn once

1) Pre-heat oven to temperature given.

The cooking times and temperatures given are guidelines only and depend upon the type and the qualities of the food.



Tips for the microwave

Result	Remedy
You cannot find details for the amount of food prepared.	Look for a similar food. Increase or shorten the length of the cooking times according to the following rule: Double the amount = almost double the time Half the amount = half the time
The food has got too dry.	Set shorter cooking time or select lower microwave power.
The food is still not defrosted, hot or cooked after the time has elapsed.	Set longer cooking time or select higher microwave power. Please note that taller dishes need longer.
After the cooking time has elapsed, the food is overheated at the edge but is still not ready in the middle.	Next time select a lower power and a longer time. Stir liquids, e. g. soup, halfway through.

Test dishes in accordance with IEC 60705

(Microwave power 1000 Watt)

The quality and function of microwave appliances are tested by test institutes using special dishes.











Dish	Power Watt	Oven function	Oven level	Cook time Mins.	Standing time Mins.	Comment
Egg custard (12.3.1)	300		Glass floor	30-40	120	Turn dish once after half the time
Fatless sponge (12.3.2)	600		Glass floor	8-10	5	
Cooking meat loaf (12.3.3)	500		Glass floor	20-22	5	Cover, turn dish once halfway through cooking time
Potato gratin (12.3.4)	500		1	40	5	
Cake (12.3.5)	200		2	20	5	
Grilling chicken 1,200 g (12.3.6)	300		1	35	5	Turn after 15 mins.
Defrosting mince (13.3.)	100		Glass floor	15-20	5	Turn after half the time, remove defrosted parts
Defrosting raspberries (B.2.1)	100		Glass floor	11-13	5	Cover

Programmes

The appliance has 12 programmed functions, which can be selected one after the other using the Recipes  button.

For settings, see section Additional functions: Microwave Programmes.

Pro-gramme	Func-tion	Recipe		Weight			Time as per Pre-setting	Keep warm func-tion "HH"
				Pre-setting	min.	max.		
P1	Defrost 	Poultry		1,000 g	100 g	1,500 g	19 mins. 40 secs.	No
P2		Meat		800 g	100 g	1,500 g	17 mins. 36 secs.	No
P3		Fish		1,000 g	100 g	1,500 g	15 mins. 20 secs.	No
P4		Bread		500 g	100 g	1,500 g	6 mins.	No

Pro-gramme	Function	Recipe		Weight			Time as per Pre-setting	Keep warm function "HH"	
				Pre-setting	min.	max.			
P5	Boil 	Frozen vegetables (small) + 50 ml water		800 g	100 g	1,000 g	15 mins. 44 secs.	Yes	
P6		Frozen vegetables (large) + 50 ml water		800 g	100 g	1,000 g	22 mins. 56 secs.	Yes	
P7		Fresh vegetables (small) + 50 ml water		800 g	100 g	1,000 g	24 mins.	No	
P8		Fresh vegetables (large) + 50 ml water		800 g	100 g	1,000 g	26 mins. 40 secs.	No	
P9		Potatoes + 100 ml water		600 g	100 g	1,000 g	17 mins. 12 secs.	No	
P10		Fish		1,000 g	100 g	1,000 g	21 mins. 40 secs.	Yes	
P11		Combi Function 1)	Potato gratin		1,000 g	400 g	1,800 g	30 mins.	Yes
P12		 	Chicken		1,000 g	500 g	1,400 g	30 mins.	Yes

1) With the functions Defrost and Boil turn the food several times

POTATO GRATIN (for 4-5 people)**Ingredients:**

- 750 g potatoes
- 100 g Gruyère or Emmental cheese, grated
- 1 egg
- 250 ml milk or cream
- 2 tablespoons butter
- 1/2 tablespoon thyme
- 1 clove of garlic, peeled
- Salt, pepper, nutmeg

Method:

Peel potatoes, cut into approx. 3 mm thick slices, dry and then season with salt and pepper.

Place half of the potato slices in a greased, oven-proof dish. Sprinkle some grated cheese over them. Layer the rest of the potato slices over this and sprinkle the rest of the cheese on the top.

Crush the clove of garlic and beat it together with the eggs, the milk and the cream. Salt the mixture and pour over the potatoes.

Place knobs of butter on the gratin.

Setting	Oven level	Cook time
P11 POTATO GRATIN	2	30 mins.

CHICKEN 1200 G**Ingredients:**

- 1 chicken (1,000 - 1,200 g)
- 2 tablespoons oil
- Salt, pepper, paprika and curry powder

Method:

Wash the chicken and dry it with kitchen paper.

Mix the spices with the oil and use the mixture to coat the chicken evenly inside and out.

Then place the chicken breast-side down in an ovenproof dish or glass dish with perforated insert (special accessory).

Halfway through the roasting time turn the chicken.

After the first acoustic signal, check how the meat is cooking. If necessary, lengthen the roasting time until the second audible signal (about 10 mins.).

Setting	Oven level	Cook time
P12 CHICKEN 1200 G	2	30 mins.

Cleaning and Care



Warning: For cleaning, the appliance must be switched off and cooled down.

Warning: For safety reasons, do not clean the appliance with steam jet or high-pressure cleaning equipment.

Attention: Do not use any scouring agents, sharp cleaning tools or scourers.

Outside of the appliance

- Wipe the front of the appliance with a soft cloth and warm water and washing up liquid.
- For metal fronts, use normal commercially available cleaning agents.

Oven interior

Clean the appliance after each use. In this way, dirt is easier to clean off and is not allowed to burn on.

1. When the oven door is opened, the oven light switches itself on automatically.
2. After every use, wipe the oven with a solution of washing-up liquid and allow to dry.



Remove stubborn dirt with special oven cleaners.



Important: if using an oven cleaner spray, please follow the manufacturer's instructions exactly.

Accessories

Wash up all insertable parts (grill, side rails, etc.) after each use and dry well. For easier cleaning, leave to soak for a while.

Side rails

The left and right-hand side rails can be removed from the oven, so that the side walls of the oven can be cleaned.

Removing side rails

To remove rails, take hold of them and then raise and lift them out of the mounts.

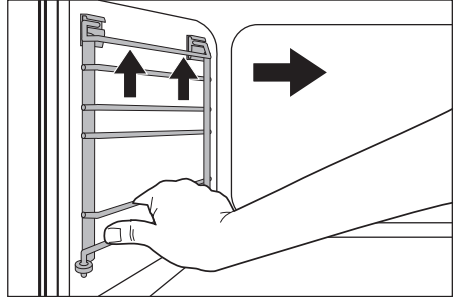

Replacing the side rails

To insert rails, re-insert them into the mounts and lower them.

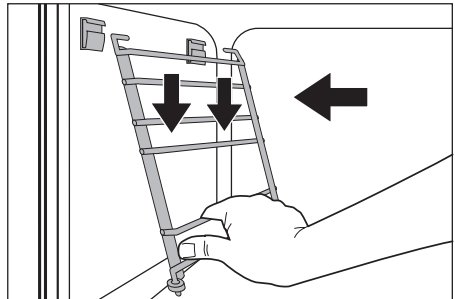

Oven lighting



Warning: Risk of electric shock! Before replacing the oven light bulb:

- Switch oven off.
- Take the fuses out of the fuse box or switch off.



To protect the oven light bulb and the glass cover, lay a cloth on the floor of the oven.

Replacing the side oven light bulb/ Cleaning the glass cover

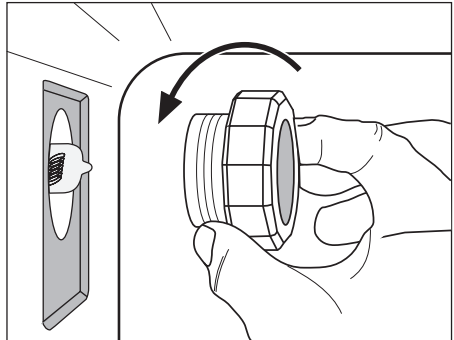

1. Take out the side rails on the left.
2. Take off the glass cover by turning it anti-clockwise and clean it.
3. If necessary: Replace with **halogen oven light bulb 20 Watt, 12 V, 300°C heat-resistant.**



Always take hold of the halogen light bulb with a cloth, to avoid burning on grease residues.

4. Re-fit the glass cover.
5. Replace the side rails.

What to do if ...

Problem	Possible cause	Remedy
The oven is not heating up	The oven has not been switched on	Switch oven on
	The clock has not been set	Set the current time on the clock
	The required settings have not been made	Check the settings
	The oven's safety cut-out has been triggered	See Safety Cut-out
	The child safety device is activated.	Deactivate child safety device
	The house wiring fuse (in the fuse box) has tripped	Check fuse If the fuses trip several times, please call a qualified electrician
The microwave is not working	The oven door is not properly closed	Close the oven door
	The door seals and door seal surfaces are dirty	Clean door seals and door seal surfaces
	The Start  button was not touched	Press the Start  button.
The oven lighting is not operating	The oven light bulb is faulty	Replace oven light bulb
"d" is lit in the display and the oven is not heating up Fan not operating	Test mode is switched on	Switch off the appliance Press and hold  and + buttons at the same time until acoustic signal sounds and "d" indicator goes out

If you are unable to remedy the problem by following the above suggestions, please contact your dealer or the Customer Care Department.



Warning! Repairs to the appliance are only to be carried out by qualified service engineers. Considerable danger to the user may result from improper repairs.



If the appliance has been wrongly operated, the visit from the customer service technician or dealer may not take place free of charge, even during the warranty period.



Advice on cookers with metal fronts:

Because of the cold surface at the front of the cooker, opening the oven door during (or just after) baking or roasting may cause the glass to steam up.

Installation Instructions



Important: The new appliance may only be installed and connected by a registered installation engineer. Please comply with this. If you do not, any damage resulting is not covered by the warranty.



Safety information for the installer

- The set-up of the electrical installation is arranged so that the appliance can be isolated from the mains with a minimum 3mm all-pole contact separation.
Suitable separation devices include e. g. cut-outs, fuses (screw fuses are to be taken out of the holder), RCD's and contactors.
- The site must provide a connection to the electrical supply by means of a socket that is accessible and outside the coordination space.
- Anti-shock protection must be provided by the installation.
- The built-in unit must meet the stability requirements of DIN 68930.

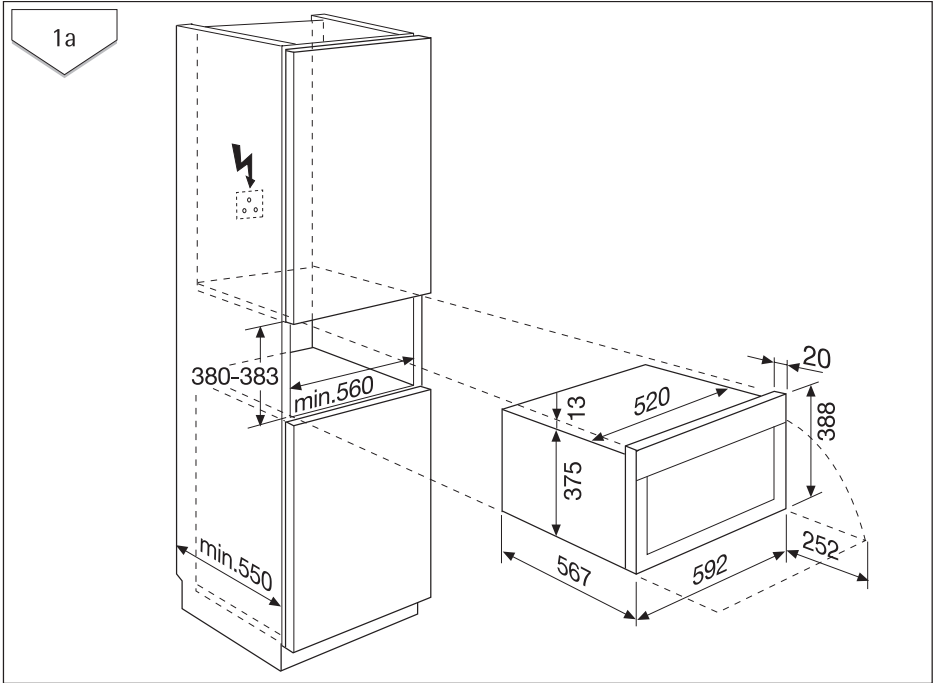

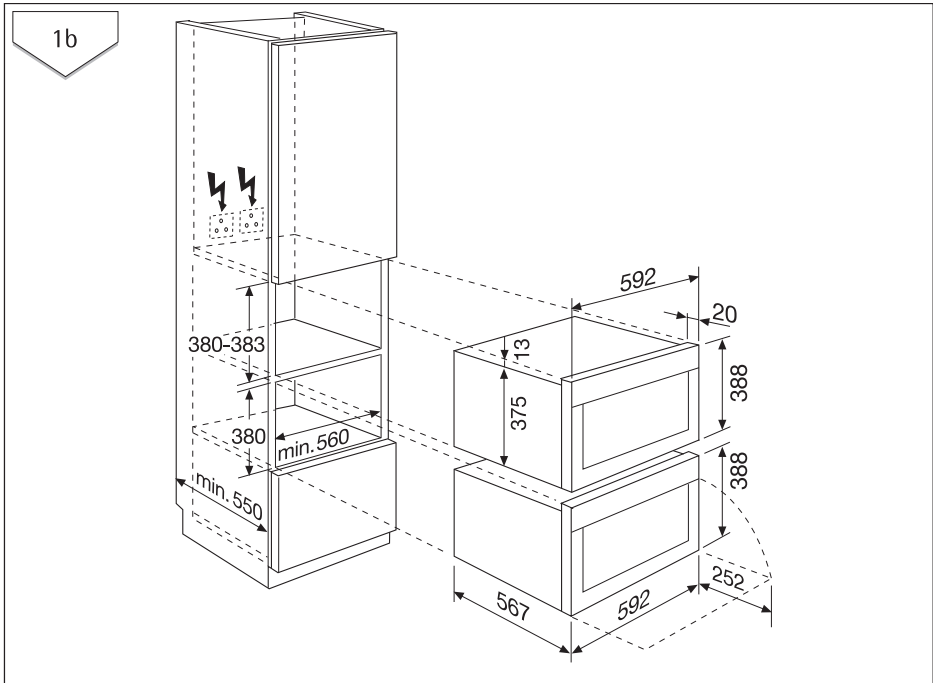

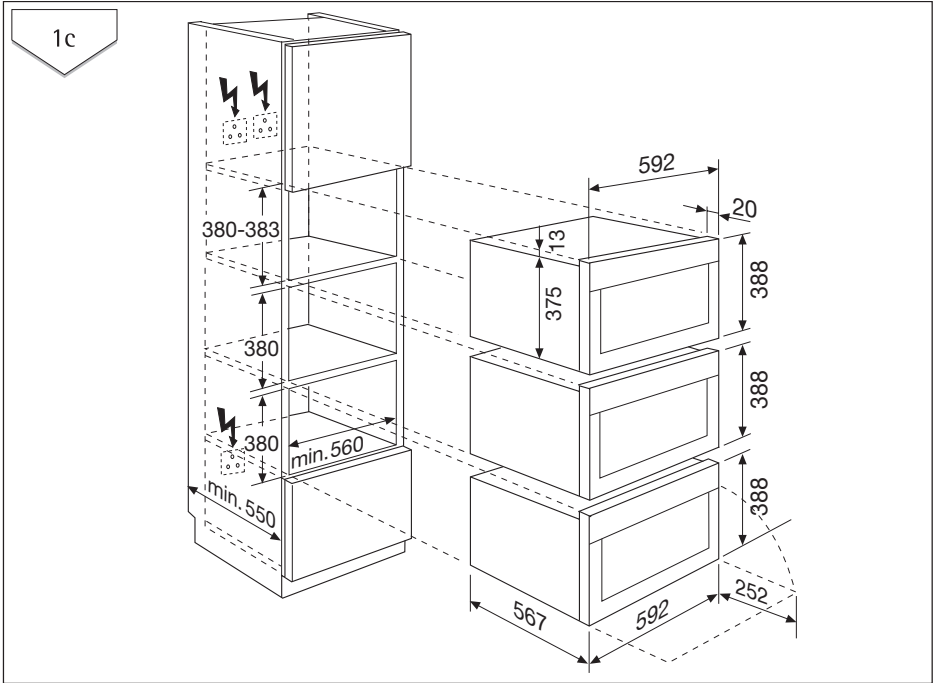

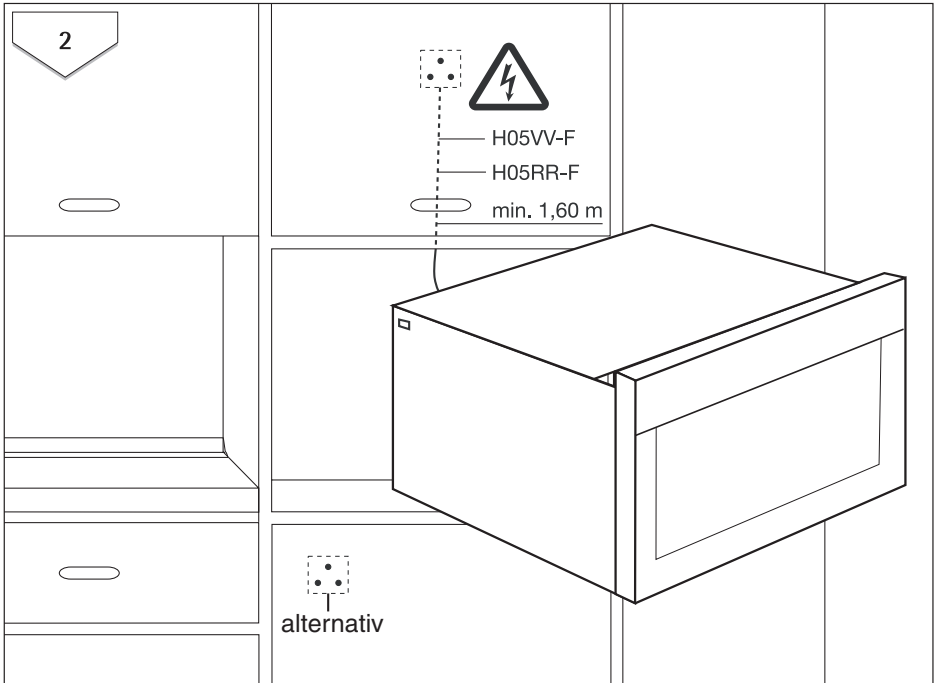

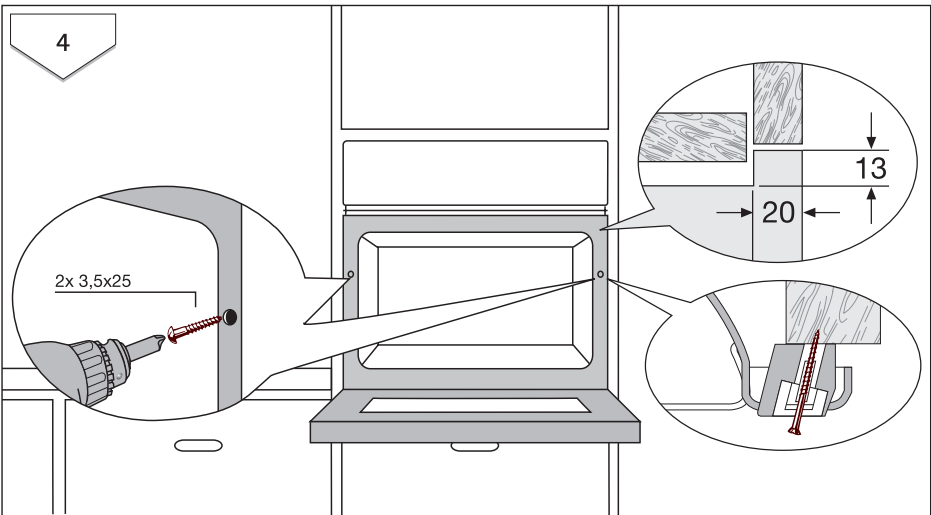
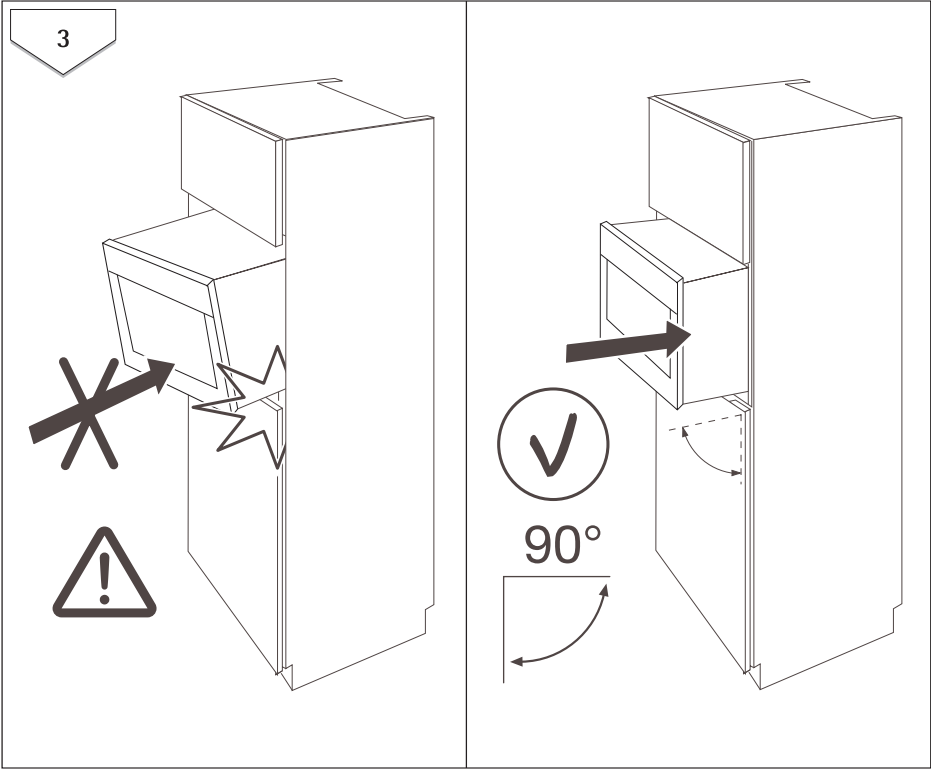

Disposal



Packaging material

The packaging materials are environmentally friendly and can be recycled. The plastic components are identified by markings, e.g. >PE<, >PS<, etc. Please dispose of the packaging materials in the appropriate container at the community waste disposal facilities.



Old appliance

The symbol  on the product or on its packaging indicates that this product may not be treated as household waste. Instead it shall be handed over to the applicable collection point for the recycling of electrical and electronic equipment. By ensuring this product is disposed of correctly, you will help prevent potential negative consequences for the environment and human health, which could otherwise be caused by inappropriate waste handling of this product. For more detailed information about recycling of this product, please contact your local city office, your household waste disposal service or the shop where you purchased the product.



Warning: So that the old appliance can no longer cause any danger, make it unusable before disposing of it.

To do this, disconnect the appliance from the mains supply and remove the mains cable from the appliance.

Guarantee/Customer Service

Belgium

DECLARATION OF GUARANTEE TERMS.

Our appliances are produced with the greatest of care. However, a defect may still occur. Our consumer services department will repair this upon request, either during or after the guarantee period. The service life of the appliance will not, however, be reduced as a result.

This declaration of guarantee terms is based on European Union Directive 99/44/EC and the provisions of the Civil Code. The statutory rights that the consumer has under this legislation are not affected by this declaration of guarantee terms.

This declaration does not affect the vendor's statutory warranty to the end user. The appliance is guaranteed within the context of and in adherence with the following terms:

1. In accordance with provisions laid down in paragraphs 2 to 15, we will remedy free of charge any defect that occurs within 24 months from the date the appliance is delivered to the first end user.
These guarantee terms do not apply in the event of use for professional or equivalent purposes.
2. Performing the guarantee means that the appliance is returned to the condition it was in before the defect occurred. Defective parts are replaced or repaired. Parts replaced free of charge become our property.
3. So as to avoid more severe damage, the defect must be brought to our attention immediately.
4. Applying the guarantee is subject to the consumer providing proof of purchase showing the purchase and/or delivery date.
5. The guarantee will not apply if damage caused to delicate parts, such as glass (vitreous ceramic), synthetic materials and rubber, is the result of inappropriate use.
6. The guarantee cannot be called on for minor faults that do not affect the value or the overall reliability of the appliance.
7. The statutory warranty does not apply when defects are caused by:
 - a chemical or electrochemical reaction caused by water,
 - abnormal environmental conditions in general,
 - unsuitable operating conditions,
 - contact with harsh substances.
8. The guarantee does not apply to defects due to transport which have occurred outside of our responsibility. Nor will the guarantee cover those caused by inadequate installation or assembly, lack of maintenance or failure to respect the assembly instructions or directions for use.
9. Defects that result from repairs or measures carried out by people who are not qualified or expert or defects that result from the addition of non-original accessories or spare parts are not covered by the guarantee.
10. Appliances that are easy to transport may be delivered or sent to the consumer services department. Home repairs are only anticipated for bulky appliances or built-in appliances.
11. If the appliances are built-in, built-under, fixed or suspended in such a way that removing and replacing them in the place where they are fitted takes more than half an hour, the costs that result therefrom will be charged for. Connected damage caused by these removal and replacement operations will be the responsibility of the user.
12. If, during the guarantee period, repairing the same defect repeatedly is not conclusive, or if the repair costs are considered disproportionate, in agreement with the consumer, the defective appliance may be replaced with another appliance of the same value.
In this event, we reserve the right to ask for a financial contribution calculated according to the length of time it has been used.
13. A repair under guarantee does not mean that the normal guarantee period will be extended nor that a new guarantee period begins.
14. We give a twelve month guarantee for repairs, limited to the same defect.

15. Except in the event where liability is legally imposed, this declaration of guarantee terms excludes any compensation for damage outside the appliance for which the consumer wishes to assert his rights. In the event of legally admitted liability, compensation will not exceed the purchase price paid for the appliance.

These guarantee terms are only valid for appliances purchased and used in Belgium. For exported appliances, the user must first make sure that they satisfy the technical conditions (e.g.: voltage, frequency, installation instructions, type of gas, etc.) for the country concerned and that they can withstand the local climatic and environmental conditions. For appliances purchased abroad, the user must first ensure that they meet the qualifications required in Belgium. Non-essential or requested adjustments are not covered by the guarantee and are not possible in all cases. Our consumer services department is always at your disposal, even after the guarantee period has expired.

Address for our consumer services department:

Belgium

Electrolux Home Products Belgium Consumer services 02/363.04.44 02/363.04.00
ELECTROLUX SERVICE 02/363.04.60
Bergensesteenweg 719
1502 Lembeek
E-mail: consumer.services@electrolux.be

Luxembourg

Grand-Duché de Luxembourg Consumer services 00 352 42 431-1 00 352 42 431-360
ELECTROLUX HOME PRODUCTS
Rue de Bitbourg. 7
L-1273 Luxembourg-Hamm
E-mail: consumer-service.luxembourg@electrolux.lu

European Guarantee

This appliance is guaranteed by Electrolux in each of the countries listed at the back of this user manual, for the period specified in the appliance guarantee or otherwise by law. If you move from one of these countries to another of the countries listed below the appliance guarantee will move with you subject to the following qualifications:

- The appliance guarantee starts from the date you first purchased the appliance which will be evidenced by production of a valid purchase document issued by the seller of the appliance.
- The appliance guarantee is for the same period and to the same extent for labour and parts as exists in your new country of residence for this particular model or range of appliances.
- The appliance guarantee is personal to the original purchaser of the appliance and cannot be transferred to another user.
- The appliance is installed and used in accordance with instructions issued by Electrolux and is only used within the home, i.e. is not used for commercial purposes.
- The appliance is installed in accordance with all relevant regulations in force within your new country of residence.

The provisions of this European Guarantee do not affect any of the rights granted to you by law.

www.electrolux.com

		
Albania	+35 5 4 261 450	Rr. Pjeter Bogdani Nr. 7 Tirane
Belgique/België/ Belgien	+32 2 363 04 44	Bergensesteenweg 719, 1502 Lembeek
Česká republika	+420 2 61 12 61 12	Budějovická 3, Praha 4, 140 21
Danmark	+45 70 11 74 00	Sjællandsgade 2, 7000 Fredericia
Deutschland	+49 180 32 26 622	Muggenhofer Str. 135, 90429 Nürnberg
Eesti	+37 2 66 50 030	Mustamäe tee 24, 10621 Tallinn
España	+34 902 11 63 88	Carretera M-300, Km. 29,900 Alcalá de Henares Madrid
France	www.electrolux.fr	
Great Britain	+44 8705 929 929	Addington Way, Luton, Bedfordshire LU4 9QQ
Hellas	+30 23 10 56 19 70	4 Limnou Str., 54627 Thessaloniki
Hrvatska	+385 1 63 23 338	Slavonska avenija 3, 10000 Zagreb
Ireland	+353 1 40 90 753	Long Mile Road Dublin 12
Italia	+39 (0) 434 558500	C.so Lino Zanussi, 26 - 33080 Porcia (PN)
Latvija	+37 17 84 59 34	Kr. Barona iela 130/2, LV-1012, Riga
Lietuva	+370 5 2780609	Verkių 29, LT-09108 Vilnius
Luxembourg	+35 2 42 43 13 01	Rue de Bitbourg, 7, L-1273 Hamm
Magyarország	+36 1 252 1773	H-1142 Budapest XIV, Erzsébet királyné útja 87
Nederland	+31 17 24 68 300	Vennootsweg 1, 2404 CG - Alphen aan den Rijn
Norge	+47 81 5 30 222	Risløkkvn. 2 , 0508 Oslo
Österreich	+43 18 66 400	Herziggasse 9, 1230 Wien
Polska	+48 22 43 47 300	ul. Kolejowa 5/7, Warsaw
Portugal	+35 12 14 40 39 39	Quinta da Fonte - Edifício Gonçalves Zarco - Q 35 2774 - 518 Paço de Arcos
Romania	+40 21 451 20 30	Str. Garii Progresului 2, S4, 040671 RO
Schweiz/Suisse/ Svizzera	+41 62 88 99 111	Industriestrasse 10, CH-5506 Mägenwil
Slovenija	+38 61 24 25 731	Electrolux Ljubljana d.o.o. Gerbiceva 98, 1000 Ljubljana

		
Slovensko	+421 2 43 33 43 22	Electrolux Slovakia s.r.o., Electrolux Domáce spotrebiče SK, Seberínho 1, 821 03 Bratislava
Suomi	www.electrolux.fi	
Sverige	+46 (0)771 76 76 76	Electrolux Service, S:t Göransgatan 143, S-105 45 Stockholm
Türkiye	+90 21 22 93 10 25	Tarlabası caddesi no : 35 Taksim Istanbul
Россия	+7 095 937 7837	129090 Москва, Олимпийский проспект, 16, БЦ „Олимпик“

Index

A		
Accessories	12, 26	
B		
Bakes and Gratins	43	
Baking	39, 40	
Baking tray	12, 26	
Baking/roasting programmes	27	
Button beep	37	
C		
Child safety device	37	
Cleaning		
Accessories	65	
Oven interior	65	
Oven light bulb	67	
Pre-cleaning	14	
Side rails	66	
Clock	15	
Clock Functions	30	
Clock Funktionen	27	
Combi Function	22	
Control panel	11	
D		
Description of the appliance	10	
M		
Memory Function	29	
Microwave	20, 53	
Microwave Quick Start	24	
O		
Oven		
accessories	12	
functions	19	
Oven shelf	12	
P		
Power setting information	25	
Preserves table	52	
Preserving	52	
R		
Ready Meals	44	
Repairs	5	
Roasting	45	
S		
Safety	5	
Side rails	66	
T		
Tables and tips		39
Test Mode		14
Time display		36
U		
Using the oven		15

Service

In the event of technical faults, please first check whether you can remedy the problem yourself with the help of the operating instructions (section “What to do if...”).

If you were not able to remedy the problem yourself, please contact the Customer Care Department or one of our service partners.

In order to be able to assist you quickly, we require the following information:

- Model description
- Product number (PNC)
- Serial number (S No.)
(for numbers see rating plate)
- Type of fault
- Any error messages displayed by the appliance

So that you have the necessary reference numbers from your appliance at hand, we recommend that you write them in here:

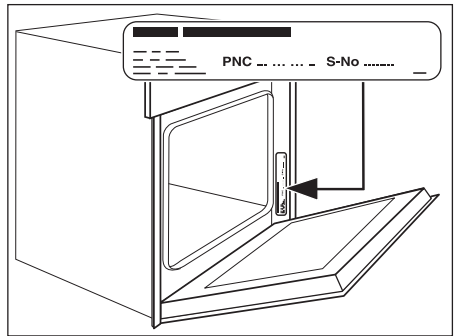

Model description:

PNC:

S No:

www.electrolux.com

Free Manuals Download Website

<http://myh66.com>

<http://usermanuals.us>

<http://www.somanuals.com>

<http://www.4manuals.cc>

<http://www.manual-lib.com>

<http://www.404manual.com>

<http://www.luxmanual.com>

<http://aubethermostatmanual.com>

Golf course search by state

<http://golfingnear.com>

Email search by domain

<http://emailbydomain.com>

Auto manuals search

<http://auto.somanuals.com>

TV manuals search

<http://tv.somanuals.com>