

EGOTERIC

A-02

Power Amplifier

OWNER'S MANUAL



CAUTION
RISK OF ELECTRIC SHOCK
DO NOT OPEN



CAUTION: TO REDUCE THE RISK OF ELECTRIC SHOCK, DO NOT REMOVE COVER (OR BACK). NO USER-SERVICEABLE PARTS INSIDE. REFER SERVICING TO QUALIFIED SERVICE PERSONNEL.



The lightning flash with arrowhead symbol, within an equilateral triangle, is intended to alert the user to the presence of uninsulated "dangerous voltage" within the product's enclosure that may be of sufficient magnitude to constitute a risk of electric shock to persons.



The exclamation point within an equilateral triangle is intended to alert the user to the presence of important operating and maintenance (servicing) instructions in the literature accompanying the appliance.

IMPORTANT SAFETY INSTRUCTIONS

- 1) Read these instructions.
- 2) Keep these instructions.
- 3) Heed all warnings.
- 4) Follow all instructions.
- 5) Do not use this apparatus near water.
- 6) Clean only with dry cloth.
- 7) Do not block any ventilation openings. Install in accordance with the manufacturer's instructions.
- 8) Do not install near any heat sources such as radiators, heat registers, stoves, or other apparatus (including amplifiers) that produce heat.
- 9) Do not defeat the safety purpose of the polarized or grounding-type plug. A polarized plug has two blades with one wider than the other. A grounding type plug has two blades and a third grounding prong. The wide blade or the third prong are provided for your safety. If the provided plug does not fit into your outlet, consult an electrician for replacement of the obsolete outlet.
- 10) Protect the power cord from being walked on or pinched particularly at plugs, convenience receptacles, and the point where they exit from the apparatus.
- 11) Only use attachments/accessories specified by the manufacturer.
- 12) Use only with the cart, stand, tripod, bracket, or table specified by the manufacturer, or sold with the apparatus. When a cart is used, use caution when moving the cart/apparatus combination to avoid injury from tip-over.
- 13) Unplug this apparatus during lightning storms or when unused for long periods of time.
- 14) Refer all servicing to qualified service personnel. Servicing is required when the apparatus has been damaged in any way, such as power-supply cord or plug is damaged, liquid has been spilled or objects have fallen into the apparatus, the apparatus has been exposed to rain or moisture, does not operate normally, or has been dropped.



- Do not expose this apparatus to drips or splashes.
- Do not place any objects filled with liquids, such as vases, on the apparatus.
- Do not install this apparatus in a confined space such as a book case or similar unit.
- The apparatus draws nominal non-operating power from the AC outlet with its POWER or STANDBY/ON switch not in the ON position.
- The apparatus should be located close enough to the AC outlet so that you can easily grasp the power cord plug at any time.
- The mains plug is used as the disconnect device, the disconnect device shall remain readily operable.
- Products with Class I construction are equipped with a power supply cord that has a 3-prong grounding plug. The cord of such a product must be plugged into an AC outlet that has a protective grounding connection.
- If the product uses batteries (including a battery pack or installed batteries), they should not be exposed to sunshine, fire or excessive heat.
- Caution should be taken when using earphones or headphones with the product because excessive sound pressure (volume) from earphones or headphones can cause hearing loss.

WARNING: TO PREVENT FIRE OR SHOCK HAZARD, DO NOT EXPOSE THIS APPLIANCE TO RAIN OR MOISTURE.

CAUTION

- DO NOT REMOVE THE EXTERNAL CASES OR CABINETS TO EXPOSE THE ELECTRONICS. NO USER SERVICEABLE PARTS ARE WITHIN.
- IF YOU ARE EXPERIENCING PROBLEMS WITH THIS PRODUCT, CONTACT ESOTERIC FOR A SERVICE REFERRAL. DO NOT USE THE PRODUCT UNTIL IT HAS BEEN REPAIRED.

China RoHS (电子信息产品污染控制管理办法)

- The information in the following table is only applicable to products for sale in the People's Republic of China.
- The products sold in the European area are manufactured in accordance with the European RoHS Directive.
- Les informations contenues dans le tableau suivant sont applicables uniquement aux produits en vente en République populaire de Chine.
- Les produits vendus en Europe sont fabriqués conformément avec la directive européenne RoHS.
- La información de la siguiente tabla se aplica únicamente a los productos de venta en la República Popular China.
- Los productos vendidos en el espacio europeo se fabrican en conformidad con la directiva europea RoHS.

产品有毒有害物质或元素的名称及含量

品名		有毒有害物质或元素					
		铅 (Pb)	汞 (Hg)	镉 (Cd)	六价铬 (Cr (VI))	多溴联苯 (PBB)	多溴二苯醚 (PBDE)
1	CHASSIS部份	×	○	○	○	○	○
2	PANEL部份	○	○	○	○	○	○
3	FOOT部份	○	○	○	○	○	○
4	螺丝部份	○	○	○	○	○	○
5	PCB Assy部份	×	○	○	○	○	○
6	线材部份	○	○	○	○	○	○
7	SEAL部份	○	○	○	○	○	○
8	AC CORD部份	×	○	○	○	○	○
9	附属品部份	○	○	○	○	○	○
10	包装部份	○	○	○	○	○	○

○：表示该有毒有害物质在该部件所有均质材料中的含量均在 SJ/T11363-2006 标准规定的限量要求以下。

×：表示该有毒有害物质至少在该部件的某一均质材料中的含量超出 SJ/T11363-2006 标准规定的限量要求。
(针对现在代替技术困难的电子部品及合金中的铅)

Contents

Thank you for choosing ESOTERIC. Read this manual carefully to get the best performance from this unit.

What's in the box.....	4
Before Use.....	5
Identifying the Parts.....	6
Speaker Connections.....	8
Connection Examples (Using as a Stereo Power Amplifier).....	9
Connection Examples (Using as a Monaural Power Amplifier).....	10
Turning On and Off the Audio System.....	11
Troubleshooting.....	12
Specifications.....	13
Rear Panel Layout.....	14

What's in the box

What's in the box

Check to be sure the box includes all the supplied accessories shown below.

Please contact the store where you purchased this unit if any of these accessories are missing or have been damaged during transportation.

Power cord x 1

Felt pads x 4



- To protect the supporting furniture surface, you may stick the felt pads to the bottom of the feet.

Power plug support bracket x 1

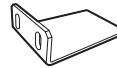

Screw for the power plug support bracket x 2



Owner's manual (this document) x 1

- Keep this manual for future reference.

Warranty card x 1

For European customers

Disposal of electrical and electronic equipment

- All electrical and electronic equipment should be disposed of separately from the municipal waste stream via collection facilities designated by the government or local authorities.
- By disposing of electrical and electronic equipment correctly, you will help save valuable resources and prevent any potential negative effects on human health and the environment.
- Improper disposal of waste electrical and electronic equipment can have serious effects on the environment and human health because of the presence of hazardous substances in the equipment.
- The Waste Electrical and Electronic Equipment (WEEE) symbol, which shows a wheeled bin that has been crossed out, indicates that electrical and electronic equipment must be collected and disposed of separately from household waste. 
- Return and collection systems are available to end users. For more detailed information about the disposal of old electrical and electronic equipment, please contact your city office, waste disposal service or the shop where you purchased the equipment.

Before Use

Read this before attempting any operations.

Placement of the unit

⚠ This unit is heavy. Take care to prevent injuries when lifting and installing it.

- High-quality tool steel is used for the spike feet, securely attached to the bottom of the unit. Although the outer feet may appear loose, the weight of the unit causes them to become firm and secure. The design effectively damps and reduces vibration.

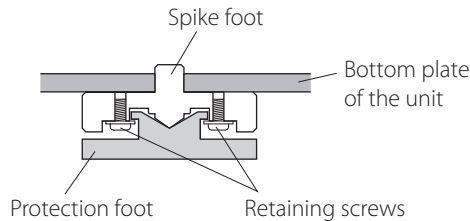

To protect the supporting furniture surface, you may stick the supplied felt pads to the bottom of the protection feet.

- Place the unit in a stable location near the audio system that you will use.
- Choose the installation location of your unit carefully. Avoid placing it in direct sunlight or close to a source of heat. Also avoid locations subject to vibrations and excessive dust, heat, cold or moisture.
- As the unit may become warm during operation, always leave sufficient space around the unit for ventilation. Make sure there is at least 8" (20 cm) of space above and at least 2" (5 cm) of space on each side of the unit. When you install the unit in a rack, use one which has ventilations and take care of temperature of the unit.
- Do not place this unit on a thick carpet.
- Do not place this unit on its side or upside down.
- When the unit is turned on, switching on the TV may cause lines to appear on the TV screen, depending on the condition of the electric waves of the TV broadcast. This is not malfunction in the unit or the TV. If you see such lines, keep this unit well away from the TV set.

Power plug support bracket

The power plug support bracket is supplied for ensuring the connection of a heavy power cord such as ESOTERIC Power Cable 7N-PC7300 MEXCEL and 6N-PC5300 by supporting their plug.

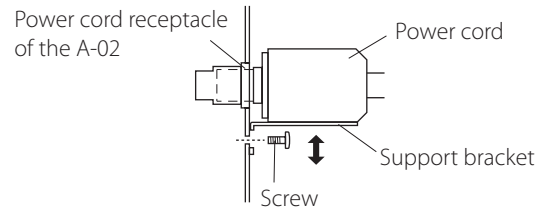

Attach the bracket and adjust its position according to the size of the plug of the power cable, and then fix it firmly with the supplied screws.

CAUTION

- Do not place any objects on this unit.
- Do not cover this unit with a cloth.
- The voltage supplied to the unit should match the voltage as printed on the rear panel. If you are in any doubt regarding this matter, consult an electrician.
- Do not open the cabinet as this might result in damage to the circuitry or cause electric shock. If a foreign object should get into the unit, contact your dealer or service company.
- When removing the power plug from the wall outlet, always pull directly on the plug, never yank on the cord.

Maintenance

If the surface of the unit gets dirty, wipe it with a soft cloth or use diluted mild liquid soap. Allow the surface of the unit to dry completely before using.

⚠ For your safety, disconnect the power cord from the wall socket before cleaning.

- Never spray liquid directly on this unit.
- Do not use thinner or alcohol as they could damage the surface of the unit.
- Avoid allowing rubber or plastic materials to touch this product for long periods of time. It could damage the cabinet.

Identifying the Parts

Front

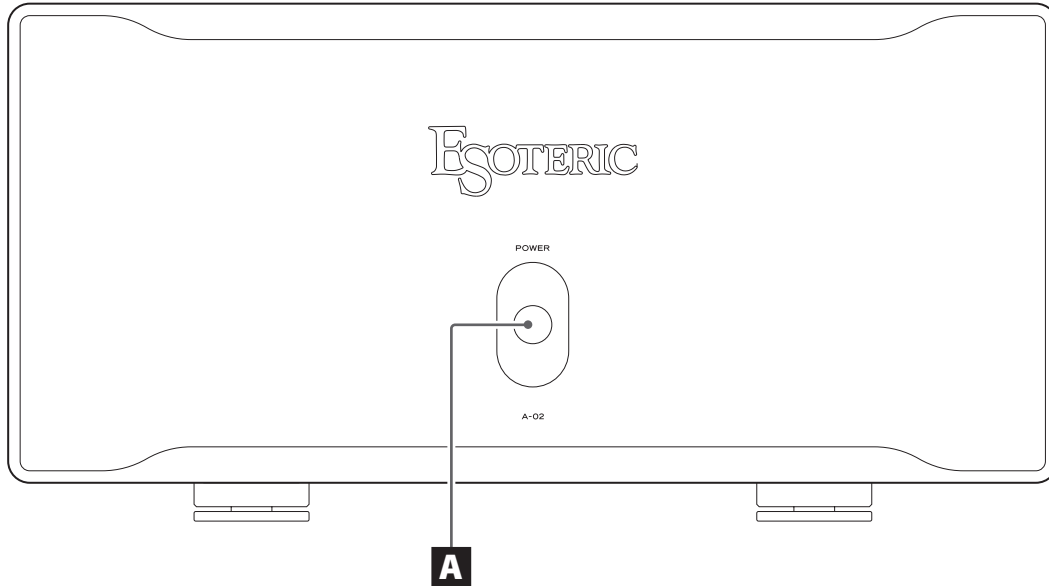

Back

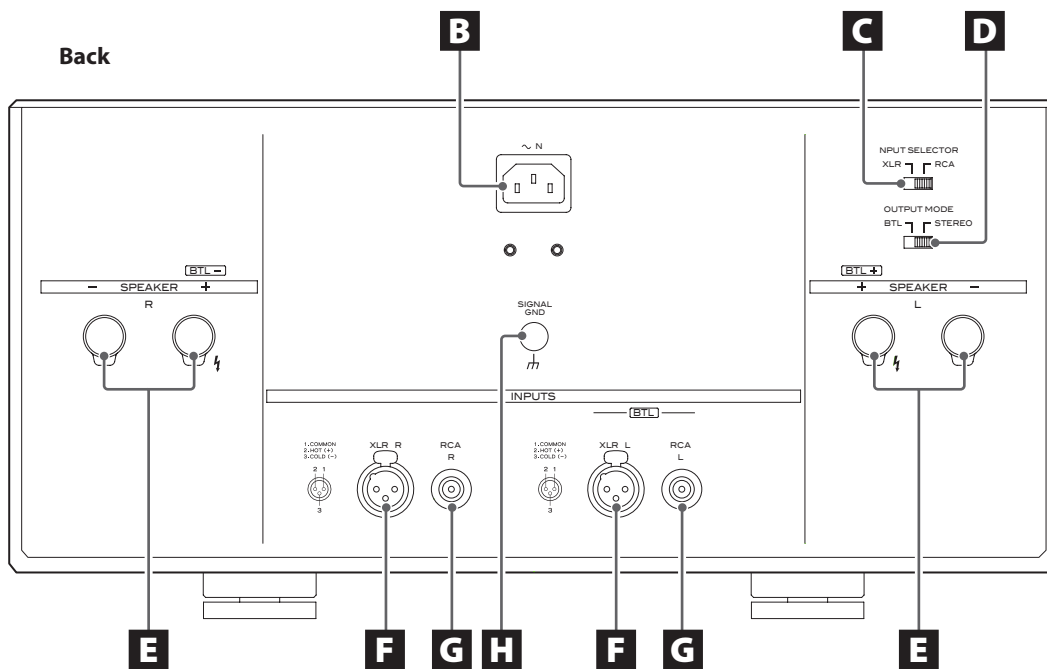

A POWER button

Press this button to turn the unit on and off.
See steps on page 11 for turning on and off the audio system including this unit.

When you turn the unit on, the blue indicator around the button blinks and no sound comes out for a few seconds. Wait until the indicator stops blinking.

- When the protection circuit is activated, the indicator around the POWER button will continue to blink and no sound will come out. If this occurs, check the items on page 12 "Protection Circuit".
- Because this unit is equipped with a high capacity transformer and capacitor, sound may occur from the power transformer when you turn it on. This is not malfunction in the unit.
- After turning the unit off, wait at least 2 seconds before turning it on again in order to prevent malfunction.
- Turn off the power when not using this unit.

B Power cord receptacle

Connect the power cord to the power cord receptacle.
After all other connections are complete, connect the power cord's plug to the AC wall socket.

⚠ Do not use any power cords other than the one included with this unit or a power cord specified by ESOTERIC. Use of other power cords may result in fire or cause electric shock.

C INPUT SELECTOR switch

Use this switch to change the input between RCA and XLR.

⚠ Do not change the input while the unit is on. Doing so may cause sudden loud noise and damage to speakers as well as harm hearing.

D OUTPUT MODE switch

Select "STEREO" when you use this unit as a stereo power amplifier.
Select "BTL (Bridged Transformer Less)" when you use this unit as a monaural power amplifier.

- You cannot connect the speakers for the both "STEREO" and "BTL" modes at the same time. When you want to change the mode, follow the steps below.
 - 1 Turn the unit off, and then disconnect the speakers from the unit.
 - 2 Change the mode by sliding the OUTPUT MODE switch.
 - 3 Connect the unit to the speakers, and then turn the unit on.

⚠ Do not change the output mode while the unit is on. Doing so may cause serious damage to the unit and the speakers.

E SPEAKER terminals

Connect these terminals to the speaker's terminals using commercially available speaker cables.
See "Speaker Connections" on the next page, and "Connection examples" on pages 9 and 10.

F XLR input terminals

Connect these terminals to the output terminals of the preamplifier using commercially available XLR balanced audio cables.
See "Connection examples" on pages 9 and 10.

- Slide the INPUT SELECTOR switch to "XLR" when you use these terminals.
- When connecting the XLR plug to the terminal connector, push it in until the lever of the connector clicks. When disconnecting the XLR plug, pull it out while pushing the lever.
- The pin assignment of the XLR input terminals is #2 HOT. Use the corresponding cables for correct polarity.

G RCA input terminals

Connect these terminals to the output terminals of the preamplifier using commercially available RCA audio cables.
See "Connection examples" on pages 9 and 10.

Make sure to connect:

White plug → White jack (L: left channel)
Red plug → Red jack (R: right channel)

- Slide the INPUT SELECTOR switch to "RCA" when you use these terminals.

H GND terminal [SIGNAL GND]

Connection of this terminal with the ground terminal of another chassis may improve sound quality.

- Note that this is NOT an electrical safety ground (earth).

ESOTERIC uses **ESOTERIC MEXCEL stress-free** cable as a reference. The following items are available in the ESOTERIC **MEXCEL** cable series.

RCA audio cable	BNC digital cable
XLR audio cable	Speaker cable
RCA digital cable	Power cable
XLR digital cable	

Speaker Connections

Connect the speakers to the SPEAKER terminals using commercially available speaker cables.

⚠ Before making or changing connections, disconnect the power cord plug from the wall socket.

- Connect 4Ω or higher impedance speakers.
- Do not connect two or more amplifiers to one speaker.
- The metal portions of the two separate wires should not touch or an electrical short can occur. Shorted wires can create a fire hazard or induce a failure in the unit.
- To prevent hum and noise, do not bundle the speaker cables together with the power cord.

Speaker cables

- Use the shortest speaker cables possible. As cables become longer, electrical resistance increases and damping characteristics are reduced. Moreover, inductance and capacitance also increase, degrading the quality of high frequency sounds.
- The left and right speaker cables should be the same length.
- Generally, the ⊕ side of the speaker cable is marked to make it distinguishable from the ⊖ side of the cable.

Connections when using the unit as a stereo power amplifier (page 9)

Connect the left channel of the SPEAKER terminals to the left speaker, and the right channel of the SPEAKER terminals to the right speaker.

Make sure to connect:

⊕ SPEAKER terminal → ⊕ terminal of the speaker
Using ⊕ side of the speaker cable

⊖ SPEAKER terminal → ⊖ terminal of the speaker
Using ⊖ side of the speaker cable

- Also make sure to slide the OUTPUT MODE switch to "STEREO".

Connections when using the unit as a monaural power amplifier (page 10)

Connect the BTL (+ and -) terminals to the speaker.

Make sure to connect:

[BTL+] terminal → ⊕ terminal of the speaker
Using ⊕ side of the speaker cable

[BTL-] terminal → ⊖ terminal of the speaker
Using ⊖ side of the speaker cable

- Slide the OUTPUT MODE switch to "BTL".
- Connect the BTL (XLR L or RCA L) terminal to the preamplifier's output terminal (left or right).

How to connect

Be sure to connect each plug securely.

Using speaker cables with bare wire

Turn the terminal cap counterclockwise to loosen it. Insert the bare wire end properly into the terminal hole, and then tighten the terminal cap.

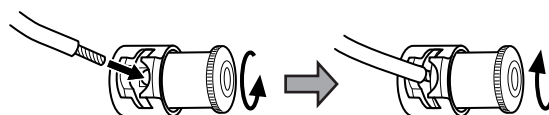

- Do not insert the insulation coating into the terminal hole. Insert only bare wire.
- The thickness of wires should be 4 mm (1/8") or less.
- Make sure it is fastened securely by pulling the cable lightly.

Using speaker cables with spades

Turn the terminal cap counterclockwise to loosen it. Insert the spade into the terminal, and then tighten the terminal cap.

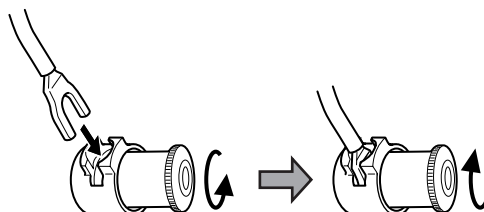

- The inside diameter of spades should be 6 mm (1/4") or more and outside diameter of spades should be 13.5 mm (1/2") or less.

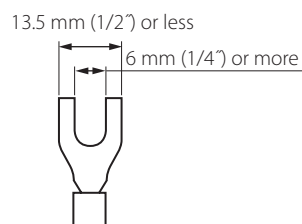

- Make sure it is fastened securely by pulling the cable lightly.

Using speaker cables with banana plugs

With the terminal cap tightened, insert the plug into the jack on the end of the cap.



- Read the instructions supplied with the banana plug.

⚠ For European customers

In accordance with European safety regulations, it is not possible to connect banana plugs into the speaker terminals on European models. The holes into which banana plugs are inserted have been covered with black caps. Connect the speakers using spades or bare wires. If the black caps become separated from the terminals, return them to their original position.

Connection Examples (Using as a Stereo Power Amplifier)

⚠ After all other connections are complete, connect the power cord plug to the AC wall socket.

- Read the instructions of each component you intend to use with this unit.
- Be sure to connect each plug securely.
- To prevent hum and noise, do not bundle the connection cords.

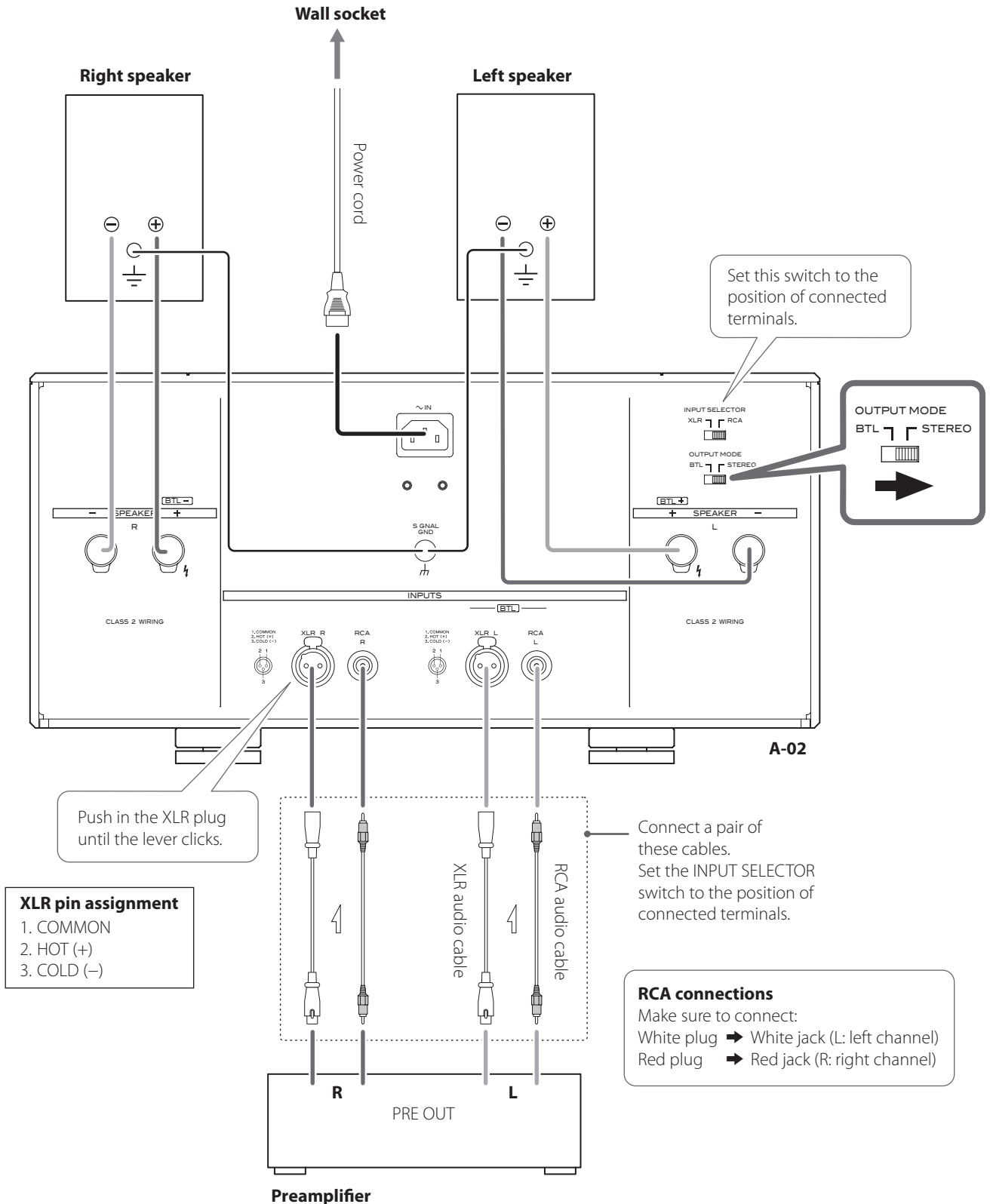

Connection Examples (Using as a Monaural Power Amplifier)

⚠ **After all other connections are complete, connect the power cord plug to the AC wall socket.**

- Read the instructions of each component you intend to use with this unit.
- Be sure to connect each plug securely.
- To prevent hum and noise, do not bundle the connection cords.

⚠ **Be sure to connect each speaker cable plug securely (see page 8).**

A loose cable connection may cause the bare wires or the spade terminal to come in contact with other metallic parts or the unit's enclosure. This may cause an electrical spark, and result in a failures of the unit, electric shock or burn injuries.

Be aware that every SPEAKER terminals carry electric voltage even when you set the OUTPUT MODE switch to "BTL".

Correct

Incorrect

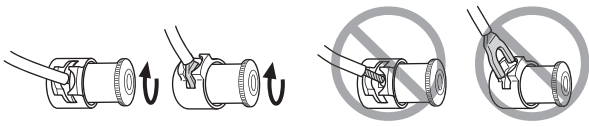

Wall socket

Right/Left speaker

Set this switch to the position of connected terminal.

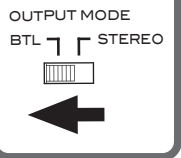
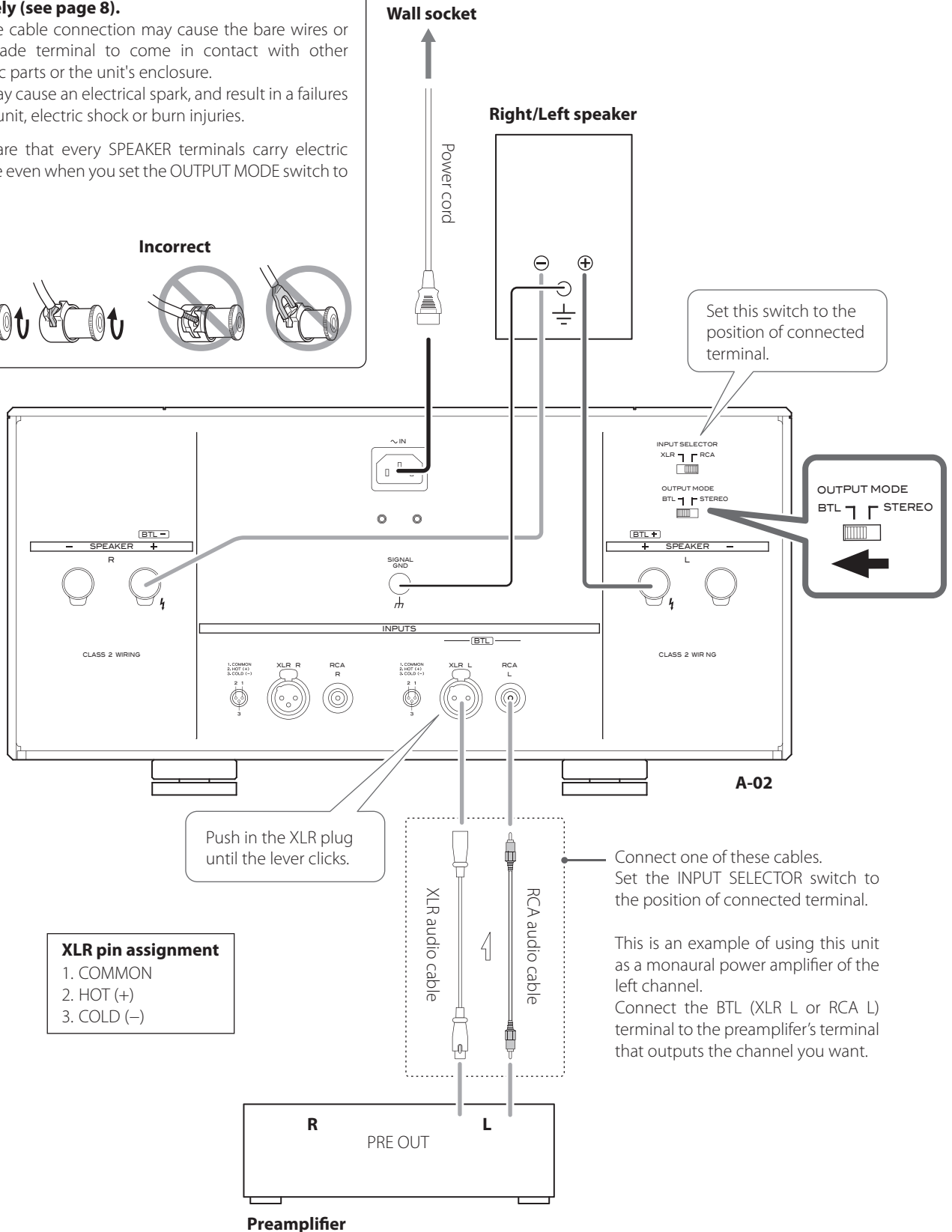

Push in the XLR plug until the lever clicks.

XLR pin assignment
 1. COMMON
 2. HOT (+)
 3. COLD (-)

Connect one of these cables. Set the INPUT SELECTOR switch to the position of connected terminal.

This is an example of using this unit as a monaural power amplifier of the left channel. Connect the BTL (XLR L or RCA L) terminal to the preamplifier's terminal that outputs the channel you want.

Turning On and Off the Audio System

Follow these steps when you turn on and off the audio system including this unit.

⚠ Failure to follow these steps may cause sudden loud noise and damage to speakers as well as harm hearing.

Turning on the audio system

- 1 Turn the volume of the preamplifier to the minimum.**
- 2 Turn on the power of the connected input source devices.**
- 3 Turn on the preamplifier.**
- 4 Press the POWER button to turn on the A-02.**

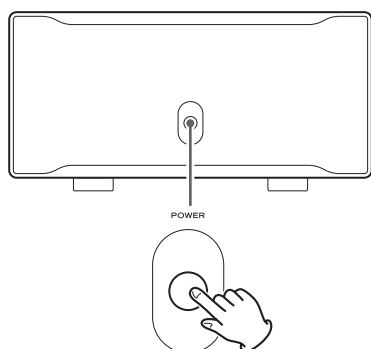

The blue indicator around the button blinks and no sound comes out for a few seconds. Wait until the indicator stops blinking, and then adjust the volume of the preamplifier.

Turning off the audio system

- 1 Stop the playback of the connected component.**
- 2 Turn the volume of the preamplifier to the minimum.**
- 3 Press the POWER button to turn off the A-02.**

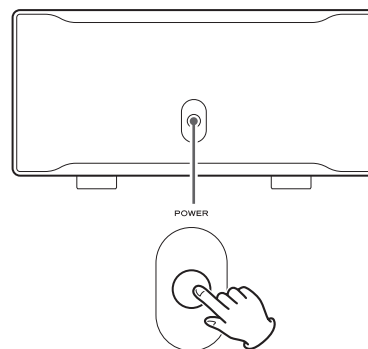

- 4 Turn off the preamplifier.**
- 5 Turn off the power of the connected input source devices.**

If you experience any problems with the unit, please take a moment to look through this chart and see if you can solve the problem yourself before you call your dealer or ESOTERIC customer service/technical support.

Moreover, the problem might be caused by something other than this unit. Confirm that connected devices are also being used properly.

No power.

- ➔ Check the connection to the AC power source. Check and make sure the AC source is not a switched outlet and if it is, the switch is turned on. Make sure there is power to the AC outlet by plugging another item such as a lamp or a fan.

There is no sound or only a very low-level sound is heard.

- ➔ Press the POWER button to turn the unit on.
- ➔ Check the operation of the preamplifier. When turning on the preamplifier, turn off the A-02 first.
- ➔ Check that the speakers, preamplifier and components are connected properly.
- ➔ Set the input and output setting of the preamplifier properly.
- ➔ Check the connections of the preamplifier. Make sure that the audio signal is output correctly.
- ➔ Check if the INPUT SELECTOR switch is set properly.
- ➔ Adjust the preamplifier volume.

Indicator around the POWER button continues to blink blue.

- ➔ The protection circuit is activated. There may be a \oplus/\ominus short in a speaker cable. Turn the unit off, and then check the cables.

Indicator around the POWER button continues to blink blue and purple.

- ➔ The protection circuit is activated. The temperature inside the unit may be too hot. Turn the unit off, and wait to let it cool down.

Sound is unstable.

- ➔ Check the polarity (\oplus/\ominus) of the speaker cable. It may be reversed.

Since this device uses a microcontroller, external noise and other interference can cause the unit to malfunction. If this occurs, turn the power off and restart operations after waiting for about one minute.

Protection Circuit

This unit has a built-in protection circuit. This protection circuit consists of an output short-circuit protection circuit, an overcurrent protection circuit and a direct current protection circuit.

When the indicator around the POWER button continues to blink blue, there may be a \oplus/\ominus short in a speaker cable. Turn the unit off, and then check the cables.

When the indicator around the POWER button continues to blink blue and purple, the temperature inside the unit may be too hot. Turn the unit off, and wait to let it cool down.

If the protection circuit continues to be activated, please contact your dealer or an authorized ESOTERIC service center.

Specifications

Speaker Outputs

Rated output power	
STEREO200 W + 200 W (1 kHz, 8 Ω) 400 W + 400 W (1 kHz, 4 Ω)
BTL800 W (1 kHz, 8 Ω)
Maximum output power	
STEREO250 W + 250 W (1 kHz, 8 Ω) (JEITA) 500 W + 500 W (1 kHz, 4 Ω) (JEITA)
BTL	1,000 W (1 kHz, 8 Ω) (JEITA)
Frequency response	5 Hz - 100 kHz (1 W, 8 Ω, ±1 dB)
Signal-to-noise ratio (S/N)	117 dB or more (JEITA)
Total harmonic distortion	
	0.009 % (1 kHz, 8 Ω, Rated output power)
Minimum required impedance	
STEREO	4 Ω
BTL	4 Ω
Gain	28 dB

Analog audio inputs

Jacks	
RCA jacks	1 stereo
XLR jacks	1 stereo
Input impedance	
RCA	150 kΩ
XLR	320 kΩ

General

Power supply	
European model	AC 230 V, 50 Hz
U.S.A./Canadian model	AC 120 V, 60 Hz
Korean model	AC 220 V, 60 Hz
Power consumption550 W
External dimensions (W x H x D)	
	445 x 220 x 430 mm (17 1/2" x 8 5/8" x 16 15/16") (including protrusions)
Weight	41.2 kg (91 lb)
Operating temperature	+10 °C to +35 °C
Operating humidity5 % to 85 % (no condensation)
Storage temperature	-20 °C to +55 °C

Accessories

- Power cord x 1
- Felt pads x 4
- Power plug support bracket x 1
- Screw for the power plug support bracket x 2
- Owner's manual (this document) x 1
- Warranty card x 1

- Design and specifications are subject to change without notice.
- Weight and dimensions are approximate.
- Illustrations may differ slightly from production models.

External dimensions

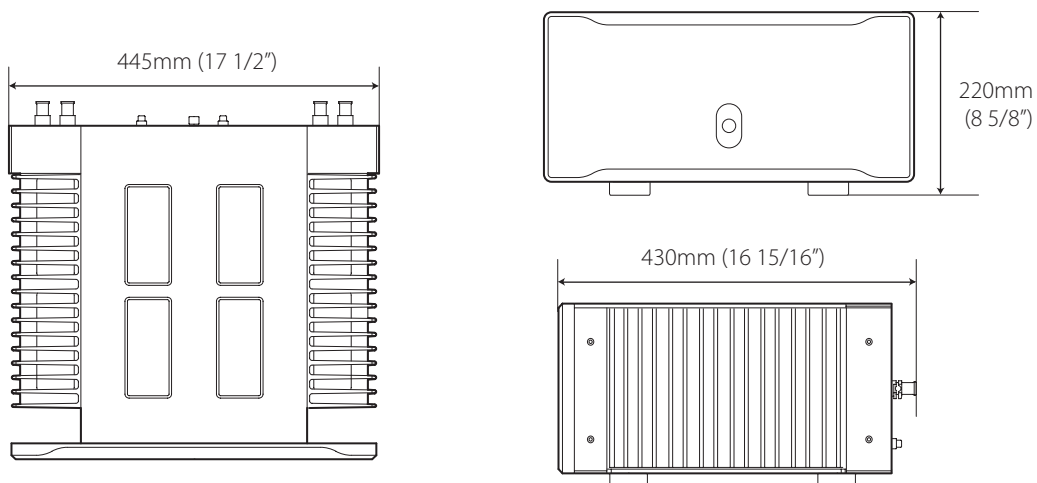

Rear Panel Layout

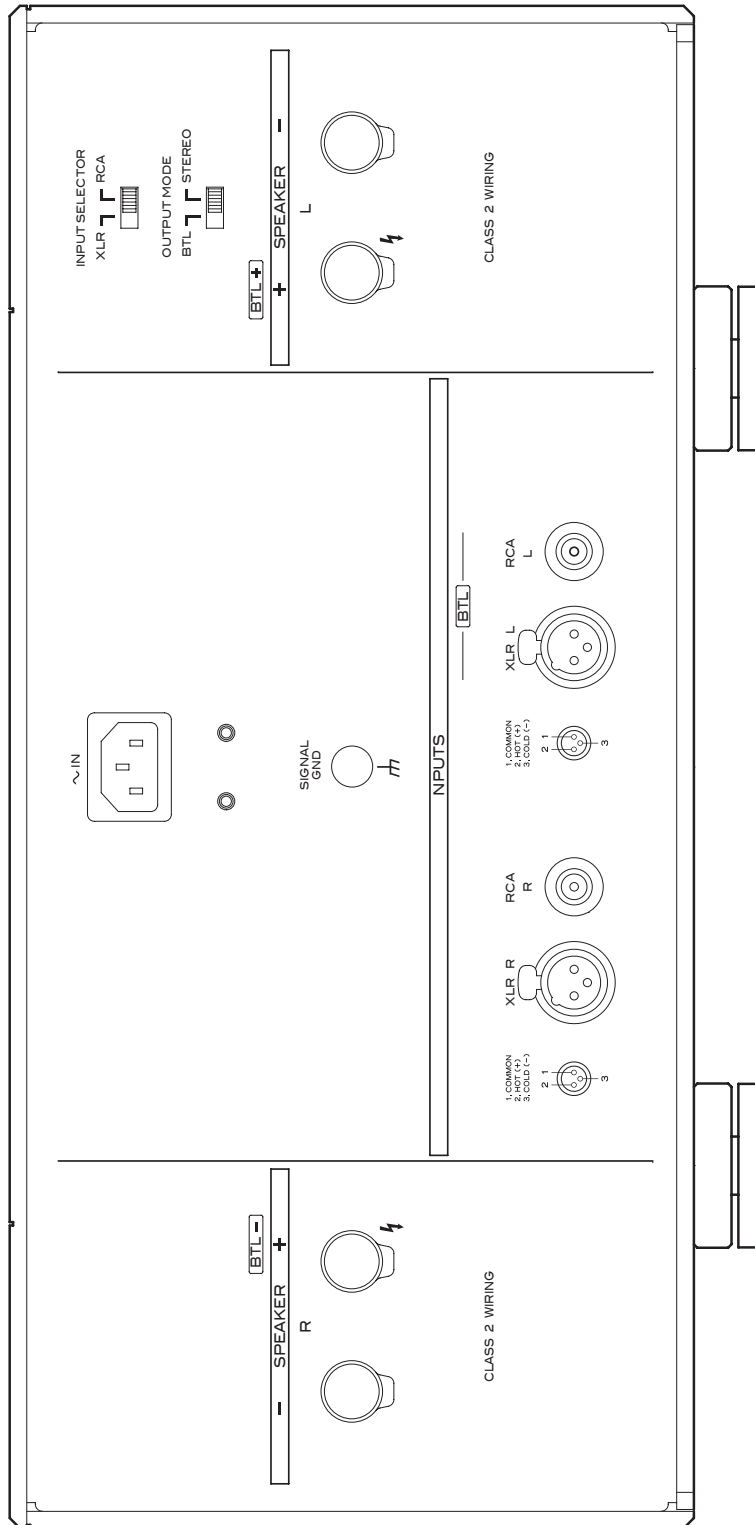

ESOTERIC

TEAC CORPORATION	1-47 Ochiai, Tama-shi, Tokyo 206-8530 Japan Phone: (042) 356-9156 e-mail: eso-os@tec.teac.co.jp
TEAC AMERICA, INC.	7733 Telegraph Road, Montebello, California 90640 U.S.A. Phone: (323) 726-0303 e-mail: esoteric_info@teac.com
TEAC CANADA LTD.	5939 Wallace Street, Mississauga, Ontario L4Z 1Z8, Canada Phone: (905) 890-8008
TEAC MEXICO, S.A. DE C.V.	Río Churubusco 364, Colonia Del Carmen, Delegación Coyoacán, CP 04100, México DF, México Phone: (5255)5010-6000
TEAC UK LTD.	Suites 19 & 20, Building 6, Croxley Green Business Park, Hatters Lane, Watford, Hertfordshire, WD18 8TE, U.K. Phone: (0845) 130-2511
TEAC EUROPE GMBH	Bahnstraße 12, D-65205 Wiesbaden-Erbenheim, Deutschland Phone: 0611-71580

This appliance has a serial number located on the rear panel. Please record the serial number and retain it for your records.

Model name: A-02 Serial number: _____

0511·MA-1696A

Free Manuals Download Website

<http://myh66.com>

<http://usermanuals.us>

<http://www.somanuals.com>

<http://www.4manuals.cc>

<http://www.manual-lib.com>

<http://www.404manual.com>

<http://www.luxmanual.com>

<http://aubethermostatmanual.com>

Golf course search by state

<http://golfingnear.com>

Email search by domain

<http://emailbydomain.com>

Auto manuals search

<http://auto.somanuals.com>

TV manuals search

<http://tv.somanuals.com>