

EGOTERIC



UX-1 Pi/UX-3 Pi

Universal Player

OWNER'S MANUAL 2

MANUEL DU PROPRIÉTAIRE ... 52



	CAUTION RISK OF ELECTRIC SHOCK DO NOT OPEN	
<p>CAUTION: TO REDUCE THE RISK OF ELECTRIC SHOCK, DO NOT REMOVE COVER (OR BACK). NO USER-SERVICEABLE PARTS INSIDE. REFER SERVICING TO QUALIFIED SERVICE PERSONNEL.</p>		



The lightning flash with arrowhead symbol, within an equilateral triangle, is intended to alert the user to the presence of uninsulated "dangerous voltage" within the product's enclosure that may be of sufficient magnitude to constitute a risk of electric shock to persons.



The exclamation point within an equilateral triangle is intended to alert the user to the presence of important operating and maintenance (servicing) instructions in the literature accompanying the appliance.

IMPORTANT SAFETY INSTRUCTIONS

- 1) Read these instructions.
 - 2) Keep these instructions.
 - 3) Heed all warnings.
 - 4) Follow all instructions.
 - 5) Do not use this apparatus near water.
 - 6) Clean only with dry cloth.
 - 7) Do not block any ventilation openings. Install in accordance with the manufacturer's instructions.
 - 8) Do not install near any heat sources such as radiators, heat registers, stoves, or other apparatus (including amplifiers) that produce heat.
 - 9) Do not defeat the safety purpose of the polarized or grounding-type plug. A polarized plug has two blades with one wider than the other. A grounding type plug has two blades and a third grounding prong. The wide blade or the third prong are provided for your safety. If the provided plug does not fit into your outlet, consult an electrician for replacement of the obsolete outlet.
 - 10) Protect the power cord from being walked on or pinched particularly at plugs, convenience receptacles, and the point where they exit from the apparatus.
 - 11) Only use attachments/accessories specified by the manufacturer.
 - 12) Use only with the cart, stand, tripod, bracket, or table specified by the manufacturer, or sold with the apparatus. When a cart is used, use caution when moving the cart/apparatus combination to avoid injury from tip-over. 
 - 13) Unplug this apparatus during lightning storms or when unused for long periods of time.
 - 14) Refer all servicing to qualified service personnel. Servicing is required when the apparatus has been damaged in any way, such as power-supply cord or plug is damaged, liquid has been spilled or objects have fallen into the apparatus, the apparatus has been exposed to rain or moisture, does not operate normally, or has been dropped.
- Do not expose this apparatus to drips or splashes.
 - Do not place any objects filled with liquids, such as vases, on the apparatus.
 - Do not install this apparatus in a confined space such as a book case or similar unit.
 - The apparatus draws nominal non-operating power from the AC outlet with its POWER switch in the OFF position.
 - The apparatus should be located close enough to the AC outlet so that you can easily grasp the power cord plug at any time.
 - An apparatus with Class I construction shall be connected to an AC outlet with a protective grounding connection.
 - Batteries (battery pack or batteries installed) shall not be exposed to excessive heat such as sunshine, fire or the like.

WARNING: TO PREVENT FIRE OR SHOCK HAZARD, DO NOT EXPOSE THIS APPLIANCE TO RAIN OR MOISTURE.

CAUTION

- DO NOT REMOVE THE EXTERNAL CASES OR CABINETS TO EXPOSE THE ELECTRONICS. NO USER SERVICEABLE PARTS ARE WITHIN!
- IF YOU ARE EXPERIENCING PROBLEMS WITH THIS PRODUCT, CONTACT TEAC FOR A SERVICE REFERRAL. DO NOT USE THE PRODUCT UNTIL IT HAS BEEN REPAIRED.
- USE OF CONTROLS OR ADJUSTMENTS OR PERFORMANCE OF PROCEDURES OTHER THAN THOSE SPECIFIED HEREIN MAY RESULT IN HAZARDOUS RADIATION EXPOSURE.

For U.S.A.

This equipment has been tested and found to comply with the limits for a Class B digital device, pursuant to Part 15 of the FCC Rules. These limits are designed to provide reasonable protection against harmful interference in a residential installation. This equipment generates, uses, and can radiate radio frequency energy and, if not installed and used in accordance with the instructions, may cause harmful interference to radio communications. However, there is no guarantee that interference will not occur in a particular installation. If this equipment does cause harmful interference to radio or television reception, which can be determined by turning the equipment off and on, the user is encouraged to try to correct the interference by one or more of the following measures:

- Reorient or relocate the equipment and/or the receiving antenna.
- Increase the separation between the equipment and receiver.
- Connect the equipment into an outlet on a circuit different from that to which the receiver is connected.
- Consult the dealer or an experienced radio/TV technician for help.

CAUTION

Changes or modifications to this equipments not expressly approved by TEAC CORPORATION for compliance will void the user's warranty.

This product has been designed and manufactured according to FDA regulations "title 21, CFR, chapter 1, subchapter J, based on the Radiation Control for Health and Safety Act of 1968", and is classified as class 1 laser product. There is not hazardous invisible laser radiation during operation because invisible laser radiation emitted inside of this product is completely confined in the protective housings.

The label required in this regulation is shown ①.

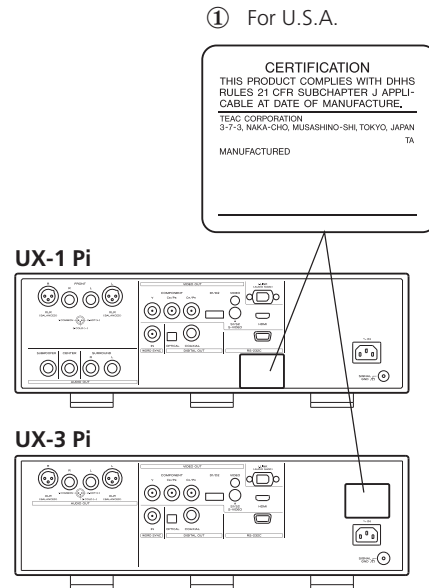

Optical pickup

Type : SLD6163RL-G
Manufacturer : SONY CORPORATION
Laser output : Less than 1mW on the objective lens
Wavelength : 785±15 nm (CD), 655±10 nm (DVD)

Contents

Thank you for choosing Esoteric. Read this manual carefully to get the best performance from this unit.

Contents	4	Settings (Speaker setup for 5.1-channel AUDIO OUT, HDMI, and i.LINK terminals)	41
Before Use	5	Settings	34
Discs	8	Analog output settings	35
Connection to a TV	10	Digital output settings	35
Connection to an amplifier etc.	12	CD Digital Direct	35
Front panel features	15	Audio DRC (Dynamic Range Control)	36
Understanding the remote control unit	16	Group playback mode (DVD audio)	36
Front panel display	18	Downmix	36
Playback	19	Video adjustment	37
Selecting groups and titles	22	Progressive scan setting	38
Skipping playback	22	DCDi	38
Selecting the playback area	22	Audio language selection	38
Selecting a chapter or track	22	Subtitle language selection	39
Fast scanning	23	Displaying subtitles	39
Repeat mode	23	On-screen display language	39
Selecting audio	24	Language Code List	40
Selecting subtitles	24	Speaker Setup (Size, Level, Distance, Test tone)	41
Changing camera angle	25	Digital output formats	43
Dimming subtitles	25	TV screen	44
Slow motion/frame advance	26	S-Video output	44
Lip sync	26	Component video output	45
Display dimming	27	PAL-NTSC conversion	45
Turning video on and off	27	Closed captioning	45
Changing the display mode	28	Still mode	45
Setting Digital Filter, HDMI, 4% down, Word Sync and i.LINK . 30		On-screen display	46
A_DF (Digital Filter)	31	Angle indication	46
HDMI (HDMI video output format)	31	Background color	46
H_ASP (HDMI aspect ratio)	32	Parental Control	46
H_EXP (HDMI expand)	32	Troubleshooting	48
H_RGB	32	i.LINK (IEEE1394)	50
H_COL	32	Specifications	51
H_FRC (HDMI Frame Rate Converter)	32		
4%DOWN	33		
WORD (Word sync)	33		
i.LINK	33		

What's in the box

Please confirm that the following accessories are in the box when you open it.

- Remote control unit x 1
- Batteries (AA, R6, SUM-3) x 2
- Felt sheet x 3
- Power cord x 1
- Owner's manual x 1
- Warranty card x 1

Conventions about This Manual

- Instructions in this manual describe the controls on the remote control. You can also use the buttons on the front panel if they have the same or similar names as those on the remote.
- The types of functions and operations that can be used for a particular disc vary depending on the features of that disc. In some cases, these functions and operations may differ from the descriptions given in this owner's manual. In this event, follow the instructions given on the screen. This owner's manual only covers basic disc operations.
- For some operations, the PROHIBIT mark "⊘" may appear on the screen. This indicates that the operation described in this owner's manual is not permitted for the current disc.
- The drawings about the TV screen and front panel display used in this owner's manual are purely for the purposes of explanation. The actual displays may differ slightly from what are shown here.

Read this before operation

- Be careful to avoid injury when moving the unit, on account of its weight. Get someone to help you if necessary.
- To protect easily scratched furniture, you may stick the felt supplied with the unit to the feet.
- As the unit may become warm during operation, always leave sufficient space around the unit for ventilation.
- The voltage supplied to the unit should match the voltage as printed on the rear panel. If you are in any doubt regarding this matter, consult an electrician.
- Choose the installation location of your unit carefully. Avoid placing it in direct sunlight or close to a source of heat. Also avoid locations subject to vibrations and excessive dust, heat, cold or moisture.
- Do not place the unit on the amplifier/receiver.
- Do not open the cabinet as this might result in damage to the circuitry or electrical shock. If a foreign object should get into the unit, contact your dealer or service company.
- When removing the power plug from the wall outlet, always pull directly on the plug, never yank the cord.
- To keep the laser pickup clean, do not touch it, and always close the disc tray.
- Do not attempt to clean the unit with chemical solvents as this might damage the finish. Use a clean, dry cloth.
- Keep this manual in a safe place for future reference.

DO NOT MOVE THE UNIT DURING PLAYBACK

During playback, the disc rotates at high speed. Do NOT lift or move the unit during playback. Doing so may damage the disc or the unit.

WHEN MOVING THIS UNIT

When changing places of installation or packing the unit for moving, be sure to remove the disc and return the disc tray to its closed position in the player. Then, press the power switch to turn the power off, and disconnect the power cord. Moving this unit with the disc loaded may result in damage to this unit.

Placement of the unit

High-quality hardened tool steel is used for the pin-point feet, securely attached to the bottom of the player. Although the cover feet may appear loose, the weight of the unit causes them to be firm and secure, and the design effectively damps and reduces vibration.

- Be careful to avoid injury when moving the unit, on account of its weight. Get someone to help you if necessary.
- To protect floors, etc. you may stick the felt supplied with the unit to the bottom of the cover feet.

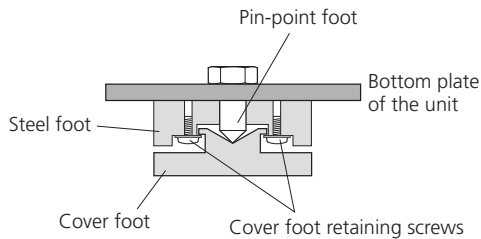

Beware of condensation

When the unit (or a disc) is moved from a cold to a warm place, or used after a sudden temperature change, there is a danger of condensation; vapor in the air could condense on the internal mechanism, making correct operation impossible. To prevent this, or if this occurs, leave the unit turned on for one or two hours. Then the unit will stabilize at the temperature of its surroundings.

Maintenance

If the surface of the unit gets dirty, wipe with a soft cloth or use diluted neutral cleaning liquid. Be sure to remove any fluid completely. Do not use thinner, benzine or alcohol as they may damage the surface of the unit.

Changing the Color System (NTSC/PAL)

If you experience picture distortion or are unable to view the monitor image, you may need to change the color setting to match your TV.

1. Turn the unit off.
2. While holding down the PAUSE button of the main unit, press the POWER button.
3. While "V Set NTSC" (or "V Set PAL") is displayed on the front panel display, press the ►► button. The display changes to "V Set PAL" (or "V Set NTSC"). Select "V Set PAL" when a PAL TV (European standard) is connected. Select "V Set NTSC" when a NTSC TV (American standard) is connected.
4. Press the POWER button to turn the unit off.

Note that you have to turn the unit off before each change.

About MOD.(Modulation) PAL:

Most models of the newly developed countdown PAL TV system detect 50 Hz (PAL)/60 Hz (NTSC) and automatically switch vertical amplitude, resulting in a display without vertical shrinkage.

If your PAL TV does not have a V-Hold control, you may not be able to view NTSC disc because the picture may roll. If the TV has a V-Hold control, adjust it until the picture stops rolling. On some TVs, the picture may shrink vertically, leaving black bands at the top and bottom of the screen. This is not a malfunction; it is caused by the NTSC-PAL conversion.

Restoring factory settings

If you have made a lot of changes to the setup, and want to restart from a known set of options, restore the unit to the factory settings as follows:

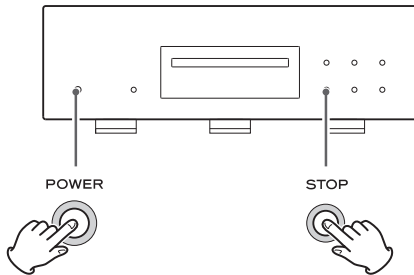

1. Turn the unit off and wait 30 seconds or longer.
2. Press the POWER button while holding down the STOP button.

Release the STOP button when "Setup CLR" appears on the display.

All memories are erased, and the unit returns to the factory settings.

For European customers

Disposal of your old appliance

1. When this crossed-out wheeled bin symbol is attached to a product it means the product is covered by the European Directive 2002/96/EC.
2. All electrical and electronic products should be disposed of separately from the municipal waste stream via designated collection facilities appointed by the government or the local authorities.
3. The correct disposal of your old appliance will help prevent potential negative consequences for the environment and human health.
4. For more detailed information about disposal of your old appliance, please contact your city office, waste disposal service or the shop where you purchased the product.



"DTS" is a registered trademark of DTS, Inc. and "DTS 96/24" is a trademark of DTS, Inc.

Manufactured under license from Dolby Laboratories. Dolby, Pro Logic and the double-D symbol are trademarks of Dolby Laboratories.

"Super Audio CD" is a registered trademark.

"DSD" is a registered trademark.

The i.LINK logo is a trademark of Sony Corporation, registered in the U.S. and other countries.

DVD Logo is a trademark of DVD Format/Logo Licensing Corporation.

HDMI, the HDMI logo and High-Definition Multimedia Interface are trademarks or registered trademarks of HDMI Licensing LLC.

This product incorporates copyright protection technology that is protected by method claims of certain U.S. patents and other intellectual property rights owned by Macrovision Corporation and other rights owners. Use of this copyright protection technology must be authorized by Macrovision Corporation, and is intended for home and other limited viewing uses only, unless otherwise authorized by Macrovision Corporation. Reverse engineering or disassembly is prohibited.

The UX-1 Pi/UX-3 Pi player uses six DACs with high-quality 14-bit 216MHz processing for video output. This type of DAC, the ADV7324, employs new Noise shaping Video (NSV) technology from Analog Devices, Inc. of the USA.





NSV technology uses multi-bit delta-sigma conversion, removing video noise and providing low noise and high linearity, without the loss of information that is often associated with analog filtering systems.

Noise Shaped Video and NSV are registered trademarks of Analog Devices, Inc.

To eliminate "jaggies" and produce clear natural images, the UX-1 Pi/UX-3 Pi uses DCDi (Directional Correlational Deinterlacing) technology. The circuits employed are from the Faroudja business division of Genesis Microchip, and enable hardware based diagonal line detection and smoothing from a pixel based image. As a result, smoother progressive-scan images can be produced, with "jaggie" noise reduced by interpolation techniques.

Type of discs that can be played on this system

This player can playback discs bearing any of the following logos:

	<p>DVD Video:</p> <ul style="list-style-type: none"> • Single-sided or double-sided discs • Single layer or dual layer discs • Dolby Digital, DTS, MPEG or Linear PCM digital audio • MPEG-2 digital video • This unit can play DVD-R discs recorded in DVD video format. • This unit can play DVD-RW discs recorded in DVD video format or DVD video recording format. <p>Discs are generally divided into one or more titles. Titles may be further subdivided into chapters.</p>
	<p>DVD Audio:</p> <ul style="list-style-type: none"> • Single sided discs • Single layer or dual layer discs • Linear or packed PCM digital audio • Some discs may contain MPEG-2 video, and Dolby Digital, DTS or MPEG digital audio. <p>Discs are generally divided into one or more groups. Groups may be further subdivided into tracks.</p>
	<p>Audio CD:</p> <ul style="list-style-type: none"> • 12cm or 8cm discs • Linear PCM digital audio <p>Audio CDs are divided into tracks.</p>
	<p>Video CD:</p> <ul style="list-style-type: none"> • 12cm or 8cm discs • MPEG-1 digital audio • MPEG-1 digital video <p>Video CDs are divided into tracks.</p>
	<p>Super Audio CD:</p> <ul style="list-style-type: none"> • Single layer, dual layer or Hybrid layer • 12cm or 8cm discs • Digital audio (DSD) <p>Super Audio CDs are divided into tracks.</p>

Region Number of DVD Video discs:

DVD players and discs are designed with region numbers that dictate the regions in which a disc can be played. If the region number on the disc you want to play does not match the region number of your DVD player, you will not be able to play the disc. In that case, an error message will appear on the screen.

The region number is printed on the rear panel of this unit.



U.S.A./Canada model



Europe model



Korea model

About DVD-RW

- DVD-RW discs that were recorded with copy-once only permission cannot be played.
- When playing a DVD-RW disc that was edited on a DVD recorder, the screen may momentarily black out at the edited point.
- When playing a DVD-RW disc that was edited on a DVD recorder, you may see scenes from just before the edited point.

About CD-R/CD-RW

CD-R/RW discs recorded in Audio CD format and finalized correctly are playable. But depending on the quality of the disc and/or the condition of the recording, some CD-R & CD-RW discs may not be playable.

Caution:

- If you record a disc using a personal computer, even if it is recorded in a compatible format, there are cases in which it may not play because of the settings of the application software used to create the disc. (Check with the software publisher for more detailed information.)
- Unfinalized CD-R/CD-RW/DVD-R/RW discs cannot be played.

Following discs cannot be played with this unit:

- CD-G, Data part of CD-EXTRA, PHOTO CD, CD-ROM and DVD-ROM discs
- discs recorded in a color system other than PAL or NTSC
- illegally produced discs
- scratched or damaged discs
- discs that are dusty, soiled or marked with fingerprints

Warning:

If you attempt to play back such discs, there is a risk that sudden loud noise can blast over the speakers at full volume and cause damage to the speakers and your hearing.

Copy-protected discs, DualDiscs and other discs that do not conform to the CD standard may not play back correctly in this player. If you use such discs in this unit, TEAC ESOTERIC COMPANY cannot be responsible for any consequences or guarantee the quality of reproduction. If you experience problems with such non-standard discs, you should contact the producers of the disc.

Example of Icons used on DVD discs:

	number of audio tracks recorded on the disc
	number of subtitles recorded on the disc
	screen aspect ratio
	disc recorded with multiple camera angles
	region code

- Always place the disc on the disc tray with the label side up. (Compact discs can be played or recorded only on one side.)
- To remove a disc from its storage case, press down on the center of the case and lift the disc out, holding it carefully by the edges.



How to remove the disc



How to hold the disc

- Should the disc become dirty, wipe the surface radially (from the center hole outward towards the outer edge) with a soft, dry cloth:

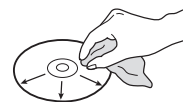

- Never use such chemicals as record sprays, antistatic sprays or fluid, benzene or thinner to clean the discs. Such chemicals will do irreparable damage to the disc's plastic surface.
- Discs should be returned to their cases after use to avoid dust and scratches that could cause the laser pickup to "skip."
- Do not expose discs to direct sunlight or high humidity and temperature for extended periods. Long exposure to high temperatures will warp the disc.
- Do not play any disc that is warped, deformed or damaged. Playing such discs may cause irreparable harm to the playing mechanisms.
- CD-R and CD-RW discs are more sensitive to the effects of heat and ultraviolet rays than ordinary CDs. It is important that they are not stored in a location where direct sunlight will fall on them, and which is away from sources of heat such as radiators or heat-generating electrical devices.
- Printable discs aren't recommended, as the label side might be sticky and damage the unit.
- Do not stick papers or protective sheets on the discs and do not use any protective coating spray.
- Use a soft oil-based felt-tipped pen to write the information on the label side. Never use a ball-point or hard-tipped pen, as this may cause damage to the recorded side.
- Never use a stabilizer. Using commercially available CD stabilizers with this unit will damage the mechanisms and cause them to malfunction.
- Do not use irregular shape discs (octagonal, heart shaped, business card size, etc.). Discs of this sort can damage the unit:

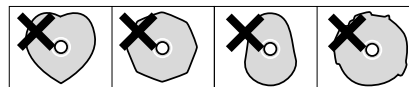

- If you are in any doubt as to the care and handling of a disc, read the precautions supplied with the disc, or contact the disc manufacturer directly.

Connection to a TV

CAUTION:

- Switch off the power to all equipment before making connections.
- Read the instructions of each component you intend to use with this unit.
- Be sure to insert each plug securely. To prevent hum and noise, avoid bundling the signal interconnection cables together with the AC power cord or speaker cables.

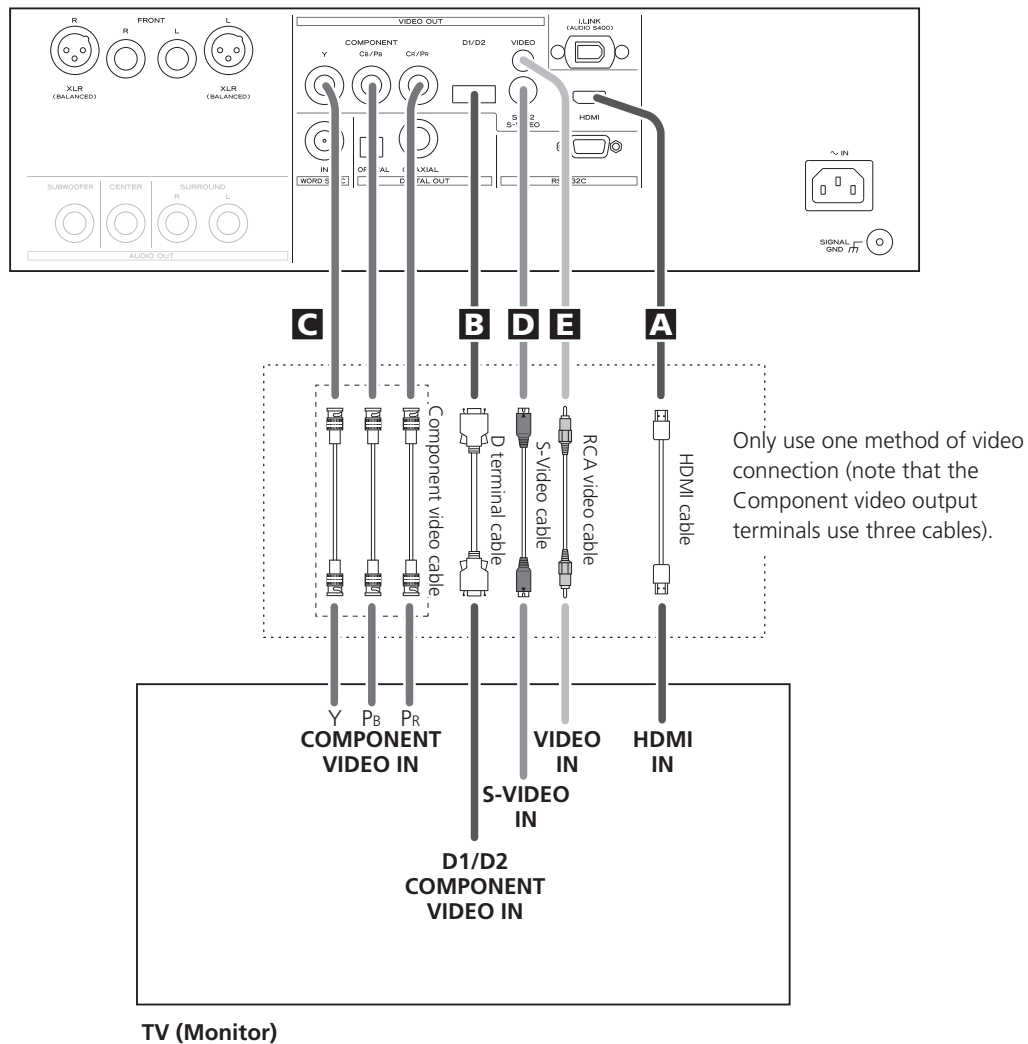

- Adjust the video aspect ratio to match that of the television (see page 44) .
- This unit adopts analog copy protection features. If the unit is connected to a TV through a VCR (video cassette recorder), the resulting playback may be affected. **Connect the unit directly to the television.**
- In all cases, use the highest quality cables for the best possible picture.

A HDMI video/audio output terminal

Use a commercially available HDMI cable to connect the unit to a HDMI compatible television or monitor.

- See pages 31-32 for further details on HDMI video output formats.
- If the television or monitor is equipped only with a DVI terminal, a suitable adaptor cable or adaptors should be used. Note that the television connected in this way must be HDCP compatible.
Also note that this connection outputs no sound.
- Make sure that you read and understand the documentation provided with the HDMI component, as well as this unit's documentation.

When using the HDMI terminal, make sure to set "HDMI" to "ON" (see page 31).

Check the following settings if necessary:
HDMI settings (see pages 31-32)
Video adjustment (see page 37)
Progressive scan setting (see page 38)
DCDi (see page 38)

To output audio from the HDMI terminal

If the connected HDMI component is capable of inputting HDMI audio, digital audio from DVD-Video, DVD-Audio, CD and video CD can be output from the HDMI terminal.

- This terminal cannot output sound from a Super Audio CD.

To output audio from the HDMI terminal, make sure to set the Digital Output setting to "ON" (see page 35).

Check the following settings if necessary:
Analog output settings (see page 35)
Digital output formats (see page 43)
Speaker setup (see pages 41-43)

B D1/D2 video output terminals (component)

By using a commercially available D terminal cable to connect the unit to a "D1 or D2 compatible" television or monitor, high-quality images, equivalent to those achieved using component video, will be displayed.

- D terminal cable is not available in all countries.

When the D1/D2 terminal is connected to a television or monitor with progressive scan capabilities, check the following settings if necessary:
Component video output (see page 45)
Video adjustment (see page 37)
Progressive scan setting (see page 38)
DCDi (see page 38)

Signal format of D1/D2 terminal (NTSC/PAL)

	480i/576i (525i/625i)	480p/576p (525p/625p)
D1 terminal	○	×
D2 terminal	○	○

Numbers in parentheses show the number of scan lines
i = interlace (flyback)
p = progressive scan

C Component video output terminals

Use commercially available BNC coaxial cables to connect the unit to the component video inputs of a suitably equipped television or monitor to enjoy high resolution video. Use these terminals in preference to S-Video or composite video connections.

- Note that these terminals cannot be connected to high definition component (Y/Pb/Pr) terminals.
- If the television or monitor is equipped only with RCA (pin) jacks for component video, a suitable adaptor cable or adaptors should be used.

When the component video output terminals are connected to a television or monitor with progressive scan capabilities, check the following settings if necessary:
Component video output (see page 45)
Video adjustment (see page 37)
Progressive scan setting (see page 38)
DCDi (see page 38)

D S-Video output terminal

Use a commercially available S-Video cable to connect the unit to the S-Video input of a suitably equipped television or monitor. Use this connection in preference to a composite video connection.

- If the picture is stretched or distorted, set "S-Video Out" to "S1" (see page 44).

E Composite video output terminal

Use a commercially available RCA (pin) video cable to connect the unit to the composite video connector of a television or monitor. Use this connection only if no other video connection method is available.

Connection to an amplifier etc. (1)

CAUTION:

- Switch off the power to all equipment before making connection.
- Read the instructions of each component you intend to use with this unit.
- Be sure to insert each plug securely. To prevent hum and noise, avoid bundling the signal interconnection cables together with the AC power cord or speaker cables.

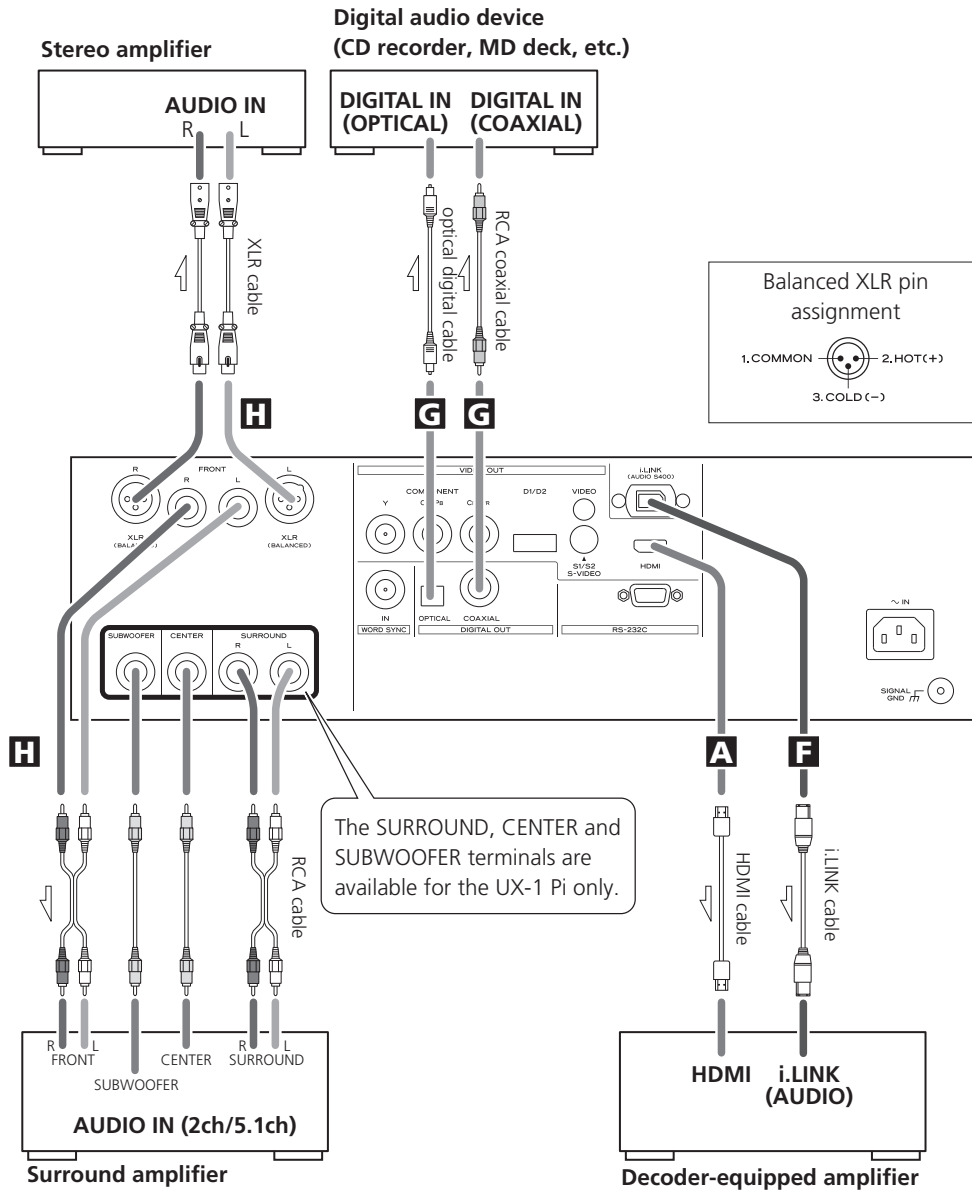

F i.LINK (AUDIO) terminal

Digital audio from Super Audio CD, DVD-Video, DVD-Audio, CD and video CD is output from i.LINK (AUDIO) terminal.

Connect the this terminal to an amplifier using a commercially available S400 compatible i.LINK (IEEE1394) 6 pin cable.

Following settings are necessary to use this terminal:

- Set the Digital Output setting to "ON" (see page 35).
- Set the i.LINK output setting to "60958" or "PCM". When you select "60958", properly set the Digital output formats.

Check the following settings if necessary:

Analog output settings (see page 35)
Speaker setup (see pages 41-43)

G Digital audio output terminals

Digital audio from DVD-Video, DVD-Audio (2ch only), CD and video CD is output from these terminals.

The unit may be connected using either coaxial or optical (TOS) commercially available cables to amplifiers including a decoder, or to digital audio devices such as CD recorders, etc.

COAXIAL: Use RCA (pin) digital audio cable
OPTICAL: Use optical digital audio cable (TOS)

- The optical terminal is covered by a shutter. Make sure that the cable is firmly inserted, but do not force the cable when connecting it or removing it, in order not to cause damage to the unit.
- This terminal cannot output the digital audio from a Super Audio CD.
- This terminal cannot output the digital surround audio from a DVD-Audio disc.
- DVD-Audio disc signals are converted where necessary from 192kHz or 176.4kHz to 96kHz/88.2kHz or 48kHz/44.1kHz. However, there may be some occasions when digital audio cannot be output by the unit from such a disc.

Following settings are necessary to use this terminal:

- Set the Digital Output setting to "ON" (see page 35).
- Properly set the Digital output formats (see page 43).

H Analog audio output terminals

2 channel (FRONT)

Use either the XLR or RCA (pin) FRONT terminals for analog stereo output.

If your amplifier has balanced XLR analog audio inputs, connect the XLR jacks on the unit to the amplifier's XLR jacks, otherwise use the RCA (pin) connections.

If you are connecting only 2 channels, set "Analog Output" to "2 ch" to downmix the multi-channel material to two channels (see page 35).

5.1 channel (UX-1 Pi only)

For surround (5.1) amplifiers with analog inputs, also use the RCA (pin) SURROUND pair, CENTER and SUBWOOFER connections (in addition to the FRONT pair).

When using 5.1 channel terminals, set "Analog Output" to "Multi ch" to enjoy surround sound (see page 35).

Connection to an amplifier etc. (2)

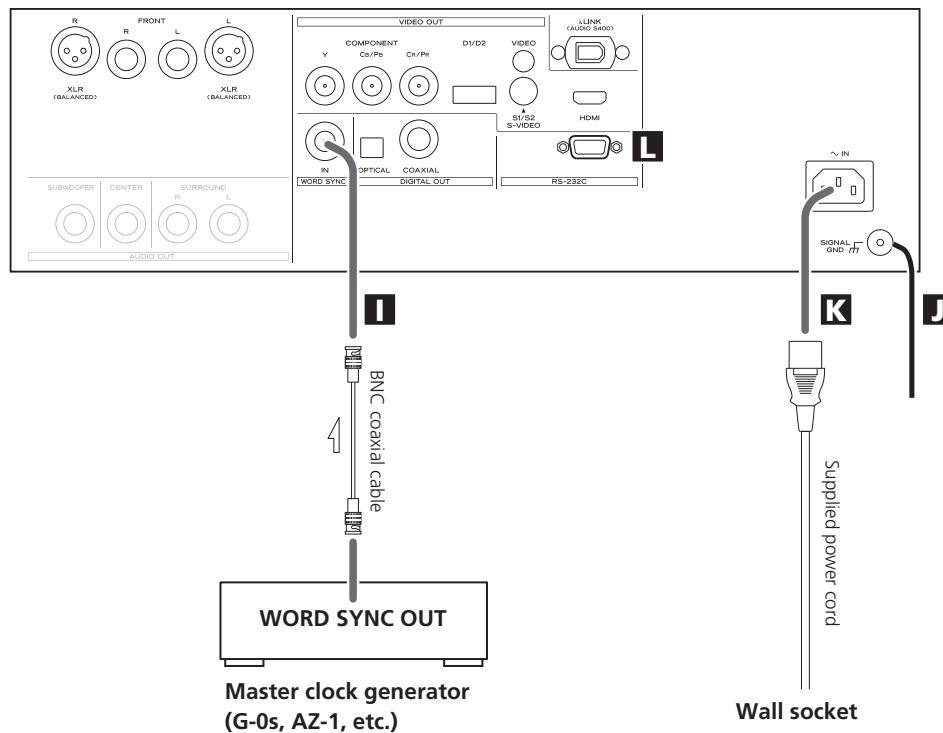

I Word sync connector

This allows the use of an externally-generated word clock connection, using a commercially available BNC coaxial cable.

Devices producing such a suitable clock signal include external D-A converters or dedicated word clock generators. Connect the SYNC OUT (or WORD OUT) of such a device to the unit.

When using the WORD SYNC connector, set "WORD" to "ON" (see page 33).

J SIGNAL GND connection

Use a commercially available PVC-covered cord to connect the signal ground terminal on the unit to the amplifier signal ground.

- Note that this is NOT an electrical safety ground (earth).

K Power cord receptacle

After all other connections have been made, insert the supplied AC power cord into this receptacle, then connect the other end of the power cord into the wall socket.

- Ensure that your AC voltage corresponds to the voltage marked on the rear panel of the unit. Consult a qualified electrician if you are in doubt.
- Use only the supplied Esoteric power cord. Use of other power cords may result in fire or electric shock. Unplug the power cord when you are not going to use the unit for an extended period of time.

L RS-232C

Control terminal for use by custom installers.

Front panel features

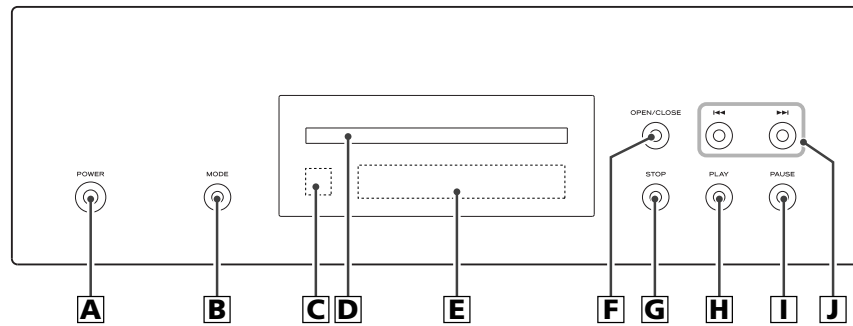

A POWER

Use this to turn the unit on and off. When the unit is on, the ring surrounding the button lights up.

The equipment draws nominal non-operating power from the AC outlet with its POWER in the standby position.

B MODE

Use this button to change following settings:
Digital filter, HDMI, 4% DOWN, Word sync, i.LINK

The ring surrounding the button lights orange when the 4% DOWN is on.

It lights blue when the word sync is on, and blinks if no valid sync signal is received.

It lights violet when both the 4% DOWN and word sync are on.

C Remote control sensor

Receives signals from the remote control unit. Point the remote control unit at this sensor when operating the remote control unit.

D Disc tray

E Display

F OPEN/CLOSE

Use this to open and close the disc tray.

G STOP

Use this to stop playback. When playback is stopped, the ring surrounding the button lights up.

H PLAY

Use this to start playback. When a disc is being played back, the ring surrounding the button lights up.

I PAUSE

Use this to pause playback. When playback is temporarily paused, the ring surrounding this button lights up.

J SKIP (I<<</>>>I)

Use these for skip operations. Pressing and holding these buttons for more than a second changes the scanning speed.

Understanding the remote control unit

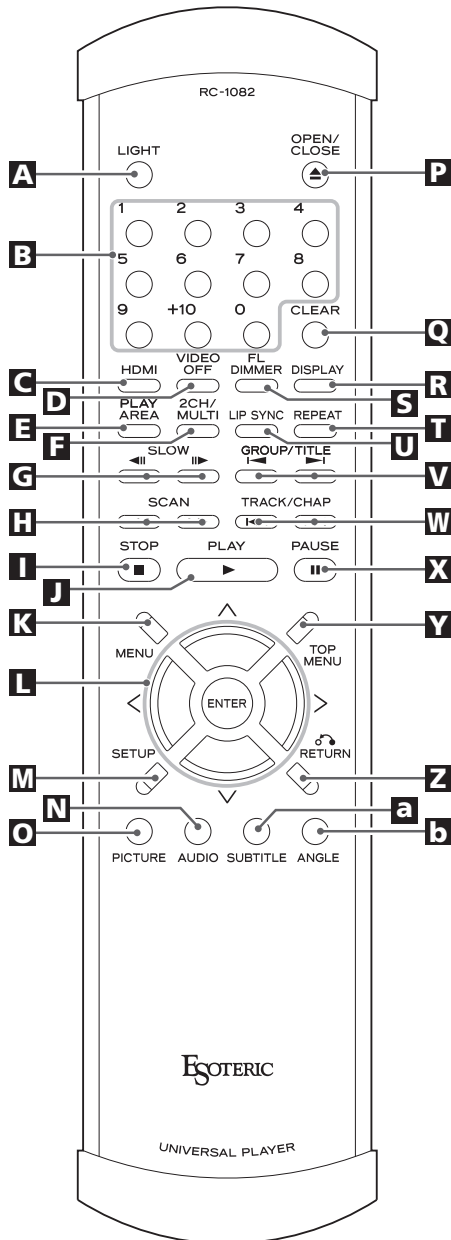

A LIGHT

Use this to illuminate the white buttons on the remote control unit for several seconds.

B Number buttons

Use these for selecting tracks by number, etc.

C HDMI

Use this to turn HDMI output on and off.

D VIDEO OFF

Use this to turn video output on and off.

E PLAY AREA

Use this with DVD audio discs and Super Audio CDs to select the playback area.

F 2CH/MULTI

Use this to select 2-channel stereo or multi-channel audio output.

G SLOW (<||/||>)

Use these for slow motion video playback.

H SCAN (<<||/>>)

Use these for fast scanning during playback.

I STOP

Use this to stop playback.

J PLAY

Use this to start playback.

K MENU

Use this button with menu-enabled DVD discs to display the DVD menu.

L Cursor buttons and ENTER

Use these cursor buttons for navigation of on-screen menus and the ENTER button to confirm selections.

M SETUP

Use this button to enter or exit the setup mode.

N AUDIO

Use this to select the audio for playback.

O PICTURE

Use this to select one of the video adjust settings; Reference, Memory 1, Memory 2 and Memory 3. (see page 37)

P OPEN/CLOSE

Use this button to open and close the disc tray.

Q CLEAR

Use this button to clear entry errors, etc.

R DISPLAY

Use this button to change the display mode.

S FL DIMMER

Use this button to change the brightness of the front panel display.

T REPEAT

Use this button to set a repeat playback mode.

U LIP SYNC

Use this to synchronize video and audio when playing back DVDs.

V GROUP/TITLE

Use these buttons to skip back or forward by one group or title.

W SKIP (◀◀/▶▶)

Use these for skip operations.

X PAUSE

Use this to pause playback.

Y TOP MENU

Use this button to return control to the top menu of a DVD.

Z RETURN

Use this button to go up a level in the menu systems. When playing back video CDs, use it to return to the top menu.

a SUBTITLE

Use this button to select the subtitle options during DVD playback.

b ANGLE

Use this button to select camera angles during DVD playback. Note that only certain discs allow this feature.

This button is also used to change the brightness of subtitles.

How to insert the batteries

Remove the cover of the remote control unit with a screwdriver. After checking the polarity (⊕/⊖) of two AA batteries, insert the batteries, replace the cover and replace the screws.

- Take care not to pinch cables with the battery case.

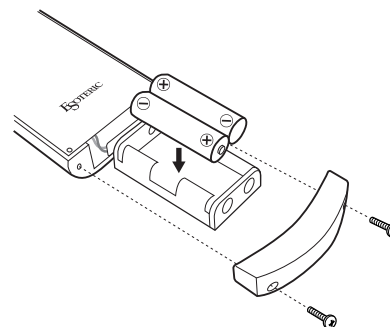
**Battery Replacement**

If the distance required between the remote control unit and main unit decreases, the batteries are exhausted. In this case replace the batteries with new ones.

Precautions concerning batteries

- Be sure to insert the batteries with correct positive “⊕” and negative “⊖” polarities.
- Use batteries of the same type. Never use different types of batteries together.
- Rechargeable or non-rechargeable batteries can be used but not mixed together. Refer to the precautions on their labels.
- When the remote control unit is not to be used for a long time (more than a month), remove the batteries from the remote control unit to prevent them from leaking. If they leak, wipe away the liquid inside the battery compartment and replace the batteries with new ones.
- Do not heat or disassemble batteries and never dispose of old batteries by throwing them in a fire.

Notes on use

- Point the remote control unit at the player’s remote sensor within seven meters (23 feet) of the player. There should not be any obstacles between the player and the remote control unit.
- Do not allow direct sun or other light to shine on the remote sensor part of the player. This may cause the remote control unit to work incorrectly.
- Note that other units with remote controls may operate incorrectly because of infrared light “overspill” when you operate this remote control unit.

Front panel display

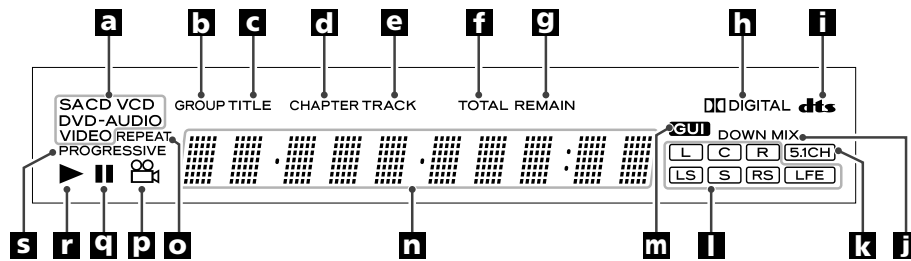

a Disc type indicator

Shows the type of disc currently loaded.

b GROUP indicator

Indicates that the group number of a DVD audio disc is being shown.

c TITLE indicator

Indicates that the title of a DVD disc is being shown.

d CHAPTER indicator

Indicates that the chapter of a DVD disc is being shown.

e TRACK indicator

Indicates that the track number of a CD, Super Audio CD or video CD is being shown.

f TOTAL indicator

Indicates that the total time is being shown.

g REMAIN indicator

Indicates that the remaining time is being shown.

h DOLBY DIGITAL indicator

Lights to show that Dolby Digital audio is being played back.

i DTS indicator

Lights to show that DTS audio is being played back.

j DOWN MIX indicator

Lights to show that a multi-channel source has been downmixed to 2 channels.

k 5.1CH indicator

Lights when the Analog Out setting is set to "Multi Channel".

l Channel indicators

Light to show which surround channels are currently in use.

m GUI indicator

Lights to show that the GUI is being displayed through the video outputs.

n Message area

Alphanumeric display to show times, titles, status messages, etc.

o REPEAT indicator

Lights when repeat play is selected

p Angle indicator

Lights when an alternative angle is available on the section of the disc being played back.

q Pause indicator

Lights when playback is paused.

r Playback indicator

Lights when playing back.

s PROGRESSIVE indicator

Lights when progressive-scan video output is enabled

Playback (1)

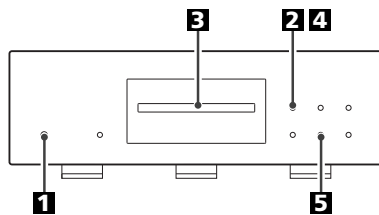
**1 Press the POWER button to turn the unit on.**

The ring surrounding the button lights when the unit is on.

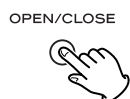
**2 Press the OPEN/CLOSE button (▲) to open the tray.**

- The tray opens after a few seconds (this delay is normal and is due to movement of the VRDS and other mechanisms within the unit).

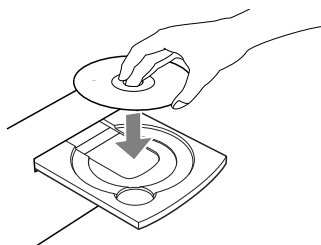
3 Insert the disc label side up.

- In the case of double-sided discs, the side to be played should be face down.
- Make sure the disc is centered in the tray in order to avoid any malfunction or jamming of the tray or damage to the disc.

4 Press the OPEN/CLOSE button (▲) again to close the tray.

The tray will close. Take care that you don't catch your fingers in the tray.

The unit reads the disc (this may take a little time). Some discs may automatically start playback.

5 Press the PLAY button to start playback if playback has not started automatically.

If a menu is shown on screen (some DVD or video discs may show such a menu), see the next section.

Playback (2)

On-screen menu

An on-screen menu is shown when a DVD or video CD with playback control (PBC) content is loaded.

The way in which the menu works may differ from disc to disc.

DVD menus

Use the cursor buttons to select the menu item from a DVD, and confirm the selection using the ENTER button.

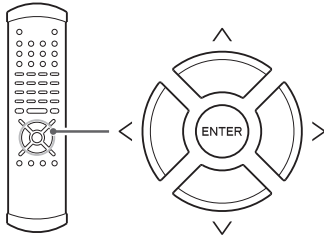

Returning to the menu screen

Press either the MENU button or (to return to the top menu) the TOP MENU button.

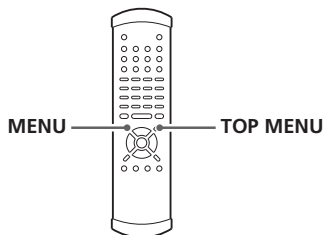

- Depending on the disc, pressing MENU or TOP MENU during playback may restart playback from the first chapter.
- This function is not available with a DVD-RW disc with VR content.

Playback control (with PBC enabled) video CDs

With these discs, the number buttons can sometimes be used to select menu items.

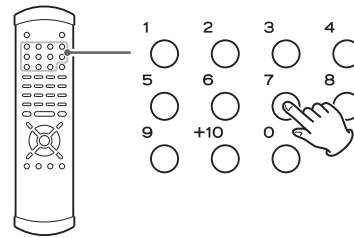

Jump between pages of multi-page menus (on some video CDs) with the SKIP buttons (I◀◀/▶▶I).

- Pressing RETURN during playback returns to the menu of a PBC video CD.
- Note that the DISPLAY and REPEAT buttons do not work during PBC playback.

Playback without PBC

In the stop mode press the number buttons or SKIP buttons (I◀◀/▶▶I) and PLAY button to playback video CDs without using the PBC facility.

DVD audio discs with picture stills

Use the SLOW buttons (◀||/||▶) to change between still images that are shown when some DVD audio discs are played back.

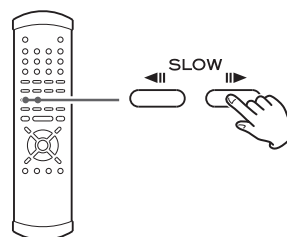

Pausing playback (freezing the picture)

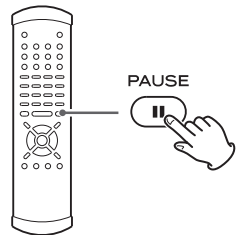

Press the PAUSE button to pause audio playback. The ring surrounding the PAUSE button on the main unit lights. Any DVD or video CD image is frozen.

Press PLAY or PAUSE to restart playback.

- If the still picture appears blurred or noisy, reconfigure the still mode to "field" (see page 45).
- Caution - do not leave player in the "pause" mode for extended periods of time. Damage to your television or the player may occur.

Stopping playback

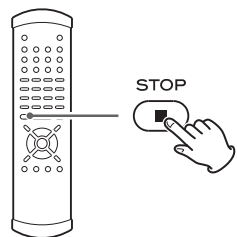

During playback, press the STOP button to stop playback. The ring surrounding the STOP button on the main unit lights.

With a video DVD or video CD, the unit enters resume mode (see the next section). Pressing STOP once again stops playback completely.

Resume mode

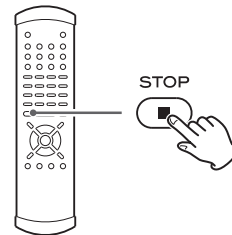

When the STOP button is pressed with a video DVD or video CD, playback is stopped, and the display shows "RESUME". Pressing PLAY continues playback.

Pressing any of the following buttons cancels resume mode:
STOP in the stop mode, OPEN/CLOSE

Opening and closing the tray

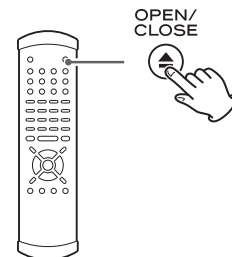

Pressing OPEN/CLOSE opens the tray if it is closed, and closes it if it is open. When the tray is opened during playback, it may take a few seconds before the disc is "unloaded" and the tray opens.

Selecting groups and titles

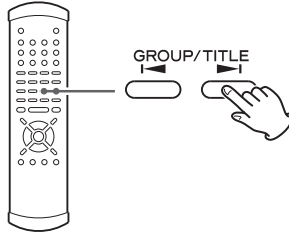

Use the remote control unit's GROUP/TITLE buttons (◀▶) to change titles and groups on DVD media.

If pressed during playback, these buttons start playback at the selected group/title. If pressed during pause or stop mode, playback is paused at the start of the selected group/title. Note that some discs may start playback when a group or title is selected, regardless of the pause or stop status.

Skipping playback

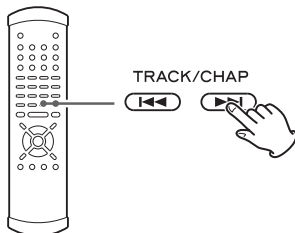

Press the SKIP button (◀▶ or ▶▶) repeatedly until the desired chapter or track is found. The selected chapter or track will be played from the beginning.

- If the ◀▶ button is pressed once during playback, playback returns to the start of the current track or chapter. If it is pressed within one second from the start of the track, playback returns to the start of the previous track or chapter (so pressing the button twice in quick succession will skip back two tracks, etc.).
- If tracks or chapters are skipped while playback is paused or stopped, playback is paused at the start of the selected track or chapter.
- When playing back video CDs with PBC, note the following: the ◀▶ button is disabled. The ▶▶ button is disabled in resume mode, but is enabled in play mode. In pause mode, the ▶▶ restarts playback at the start of the selected track.

Selecting the playback area

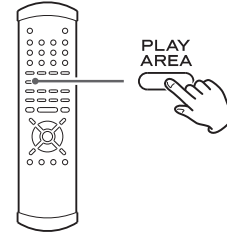

There are two types of Super Audio CDs, regular ones that contain 2-channel stereo and multi-channel stereo and hybrid discs (two-layer discs) that contain Super Audio CD and regular CD data.

Additionally, some DVD audio discs have DVD video areas.

When a hybrid Super Audio CD or a DVD audio disc is loaded and when the playback is stopped, press the PLAY AREA button to select a playback area.

- The contents accessible as DVD audio and DVD video from the same DVD disc may differ.

Selecting a chapter or track

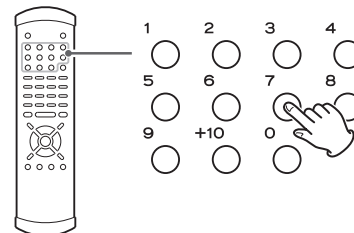

Use the number button to select tracks or chapters for playback. Use the +10 button to enter the first digit of numbers greater than 9 (repeated presses show 1-, 2-, 3- etc.) and the single digit buttons (0 through 9) for the second digit, or single-digit track numbers.

CD (including video CD and Super Audio CD) playback starts from the selected track, regardless of whether the number is selected during playback or playback is stopped or paused.

DVD playback starts from the selected chapter or track if selection is made during playback or stop. It pauses at the start of the selected track if the selection was made from pause mode. In stop mode, only chapters from the first title can be selected.

Use the CLEAR button to clear entry mistakes.

Fast scanning

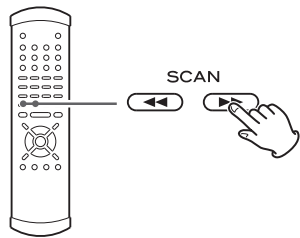

When playing back, use the SCAN button (◀◀ or ▶▶) to move backwards and forwards (sound is muted for DVD video and video CD discs). Press PLAY to restart playback at normal speed at the desired location.

Repeated presses of the SCAN buttons changes the scanning speeds. There are three speeds:

Fast (1) → Fast (2) → Fast (3) → playback at normal speed

The scanning speed is briefly shown on the display.

- You can also use the SKIP buttons of the main unit. To start scanning (or to change the scanning speed), press and hold the SKIP button for more than one second.

Notes on DVD video

Scanning does not work within menus.

If forward scanning reaches the end of the last chapter of a title, playback starts from the start of the next title.

If there is no following title, playback stops.

If backward scanning reaches the start of the first chapter, normal playback starts from there.

Notes on DVD audio and video CD (PBC playback)

Scanning does not work within menus.

If forward scanning reaches the end of a track, the scan stops and playback starts from the beginning of the next track.

If it reaches the last track on the disc, playback stops.

If backward scanning reaches the start of a track, normal playback starts from the start of that track.

Notes on video CD (non-PBC playback), audio CD and Super Audio CD

Scanning can be carried out across track boundaries.

If backward scanning reaches the start of the disc, playback starts from the beginning. If forward scanning reaches the end of the disc, scanning and playback stop.

Repeat mode

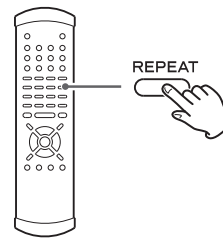

Use the REPEAT button to select the repeat mode for playback. Repeated presses of the REPEAT button cycle between the following options:

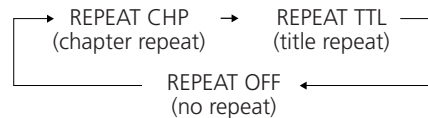
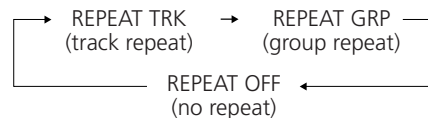
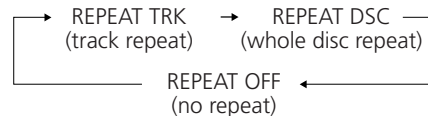
DVD video**DVD audio****CD/VCD with PBC off/Super Audio CD**

- Halting playback stops the repeat mode.
- This feature is not available for all discs. The prohibit mark “⊘” is shown on screen in such cases when an attempt is made to repeat playback.
- Repeat playback is not possible for video CDs with PBC enabled.

Chapter and track repeat

When this is selected, the currently selected track repeats. If another track is selected during repeat playback, the newly-selected track repeats.

Title, group, disc repeat

The current title/group or disc repeats. In the case of a DVD, the current title/group repeats, and for other discs, the whole contents of the disc are repeated.

Selecting audio

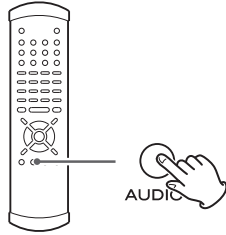

Many DVD discs include audio in different languages, as well as stereo and multi-channel surround versions of the soundtrack.

Video CDs allow the left, right or stereo channels to be selected. This facility is not available for audio CDs or Super Audio CDs.

Pressing the AUDIO button changes between the different audio tracks available, and the result is shown on screen.

- Sometimes the picture playback will appear to freeze momentarily when the audio is changed.
- It may be necessary to change the audio on some discs using the on-screen disc menu.
- Some discs cannot have their audio changed in the way described here, as well as some discs which only have one audio stream. If you attempt to select different audio with these discs, the "prohibit" mark "⊘" is shown on screen.
- Some DVD audio discs have two, or more, audio groups. In this case, select the audio group (see page 22).

Selecting subtitles

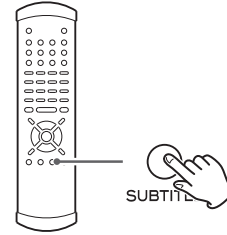

Use the SUBTITLE button to select DVD subtitles.

Repeated presses of this button cycle through available languages on a disc until OFF is reached (no subtitle).

- Subtitles do not always appear immediately after the language has been selected. It may be necessary to wait a few seconds until the subtitles appear.
- Some captions on some discs cannot be removed or changed using this button. Additionally, a disc must have at least one captioning language available for this to work. Some discs may have only one sub-caption language, in which case, the choice is obviously restricted to one subtitle or no subtitles.
- It may be necessary to change the subtitles on some discs using the on-screen disc menu.
- Some discs cannot have their subtitles changed in the way described here. If you attempt to select a different subtitle with these discs, the "prohibit" mark "⊘" is shown on screen.

Changing camera angle

When a scene recorded with multiple angles is played, the angle icon  appears on the screen. Each time you press the ANGLE button while the angle icon is displayed, the camera angle changes.

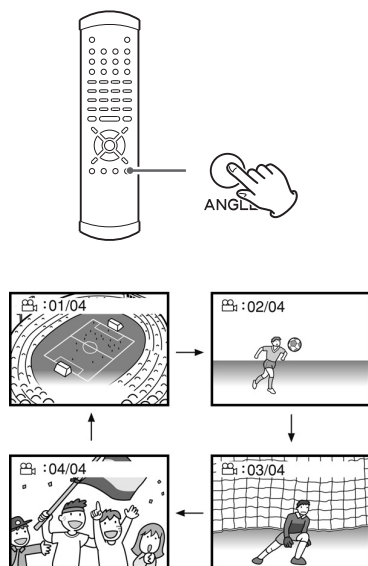

- When no other angle is recorded, the prohibit mark “⊘” will be displayed.
- You can change the setting so that the angle icon isn't displayed even when a scene recorded with multiple angles is played. See page 46 for details.
- The ANGLE button doesn't work during pause.

Dimming subtitles

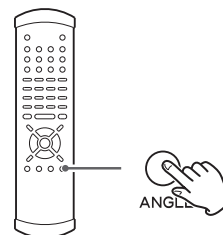

During playback of a DVD video disc, press the ANGLE button to dim subtitles.

DIMMER OFF:

Full brightness

DIMMER1:

Medium brightness

DIMMER2:

Minimum brightness

- While the angle icon  is displayed, the ANGLE button is used to change camera angle. You cannot use it to dim subtitles.

Slow motion/frame advance

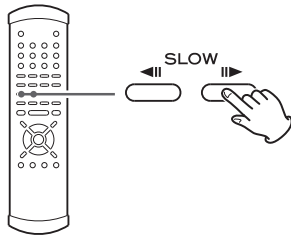

Slow motion

During playback, press either of the SLOW buttons (◀||/||▶) to slow playback in either direction.

Pressing PLAY resumes normal speed playback.

Repeated presses of the SLOW buttons change the slow playback speed:

▶|| : 1/8 → 1/4 → 1/2 → playback at normal speed

◀|| : 1/20 → 1/16 → 1/12 → playback at normal speed

Frame advance

If you press the SLOW buttons when playback is paused, you can advance or go back a frame at a time.

Pressing PLAY restarts playback at normal speed.

- Sound is muted while slow playback or frame advance is taking place.
- You cannot use backward slow motion or frame advance with video CDs. Also some discs may not allow this. In these cases, the prohibit mark "⊘" is shown on screen if you attempt slow motion or frame advance.
- If the still or slow picture appears blurred, check the "still mode" setting (see page 45).

Lip sync

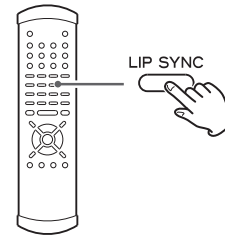

This function allows you to adjust the synchronization of the video and audio portions of a DVD.

Press the LIP SYNC button to display the current lip sync value (default is 0). Use the left and right cursor buttons to adjust the value. Positive values mean that the sound is delayed relative to the picture.

- Press LIP SYNC again to cancel this setting. Any other operational display appearing on screen will also cancel this setting. Note that lip sync should be cancelled if you need to use the left and right cursor buttons to navigate menus, etc.
- The lip sync value you set is stored when you turn the unit off, and will be remembered next time you turn the unit on again.
- This function has an effect on the signals output from the following terminals:
AUDIO OUT, i.LINK (AUDIO), HDMI
 - When using the HDMI terminal, set Dolby Digital, DTS and MPEG Audio of "Audio Digital Out" setting to "PCM" (see page 43).
 - When using the i.LINK terminal, set the i.LINK output setting to "PCM" (see pages 33).

Turning video on and off

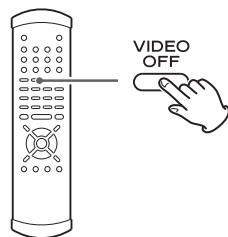

Use the VIDEO OFF button to turn video output to the television (monitor) on and off. It is not necessary to turn video off, but you may notice a slight improvement in audio quality if you turn off the video when playing back Super Audio CD discs and CDs without video images.

Note that this setting is not memorized when the power is turned off.

Display dimming

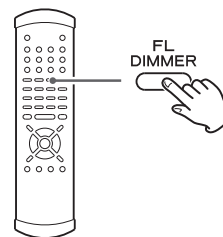

The display on the main unit can be dimmed to suit the environment in which you listen to music or watch video.

Use the FL DIMMER button to cycle between these settings.

FL Dimmer3:

Full brightness

FL Dimmer2:

Medium brightness

FL Dimmer1:

Minimum brightness

OFF:

The display and indicators are off.

FL DIMAuto (FL Dimmer Auto):

The display and indicators are off during playback. They turn on with the minimum brightness in the stop mode.

- Note that the OFF setting is not memorized when the power is turned off. When the unit is switched off with the display off, and then turned on again, the display is reset to the minimum brightness (FL Dimmer1).
- In OFF mode and FL DIMAuto mode, when you press a button such as PAUSE, the illuminations turn temporarily on.

Changing the display mode

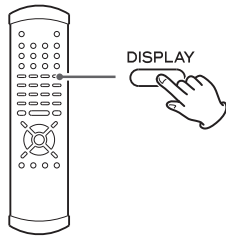

During playback, it is possible to change the display as shown here. The display on both the main unit, and the on-screen display (when the video output is on) changes.

When playback stops, the display mode reverts to the first type of display.

DVD video playback (main unit display)

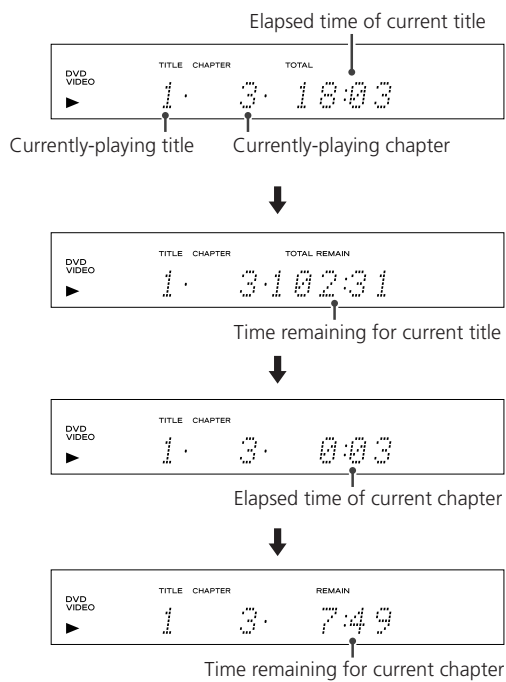

DVD video playback (on-screen display)

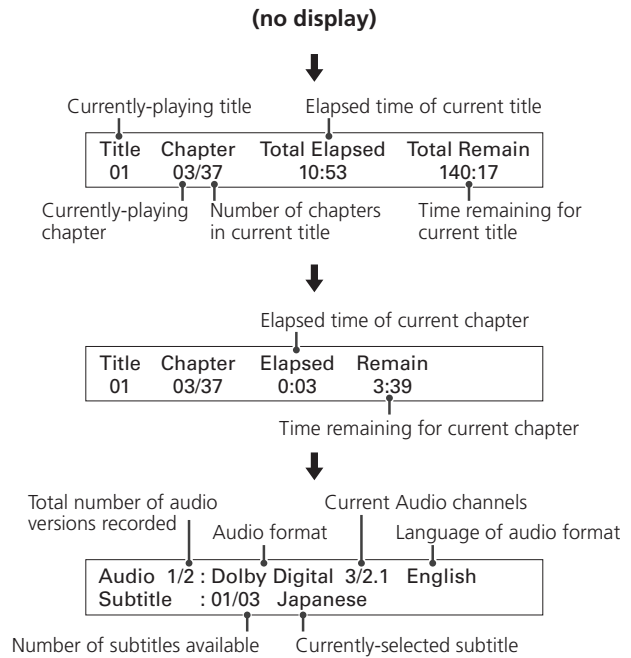

DVD video (stopped, on-screen display)



- When DVD video playback is stopped, the display on the main unit doesn't change.

DVD audio playback (main unit display)

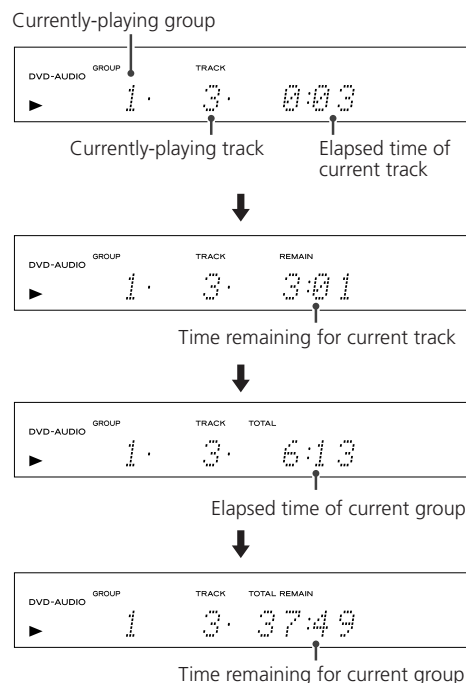

DVD audio playback (on-screen display)

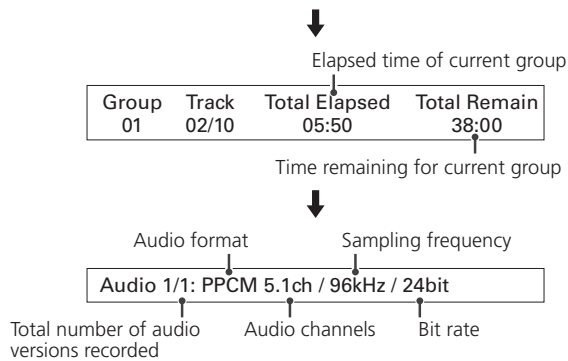
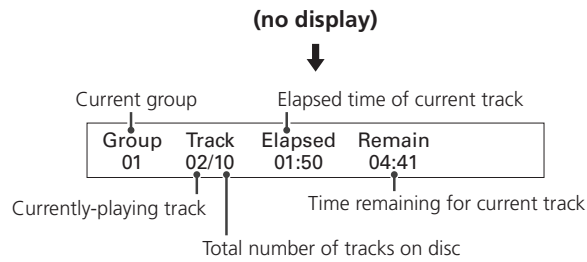

DVD audio (stopped, on-screen display)

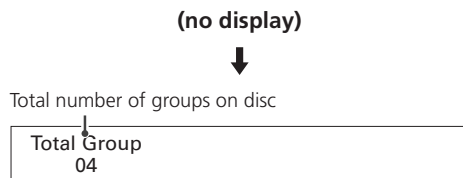

- When DVD audio playback is stopped, no display appears on the main unit.

Super Audio CD/CD/video CD playback (main unit display)

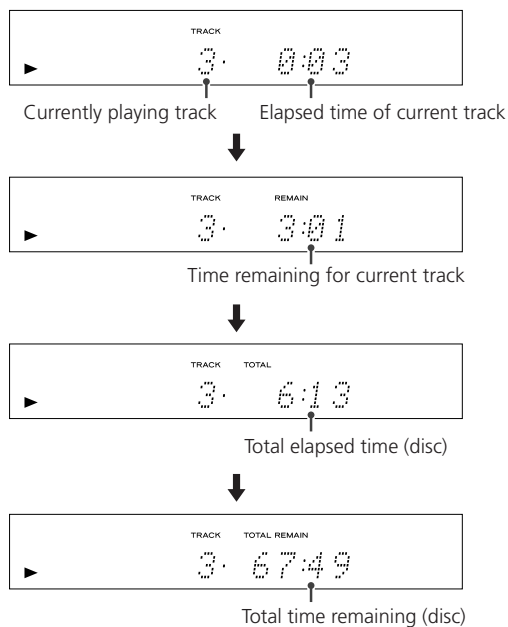

Super Audio CD/CD/video CD (stopped, main unit display)

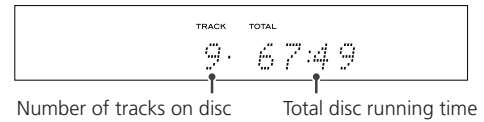

Super Audio CD/CD/video CD playback (on-screen display)

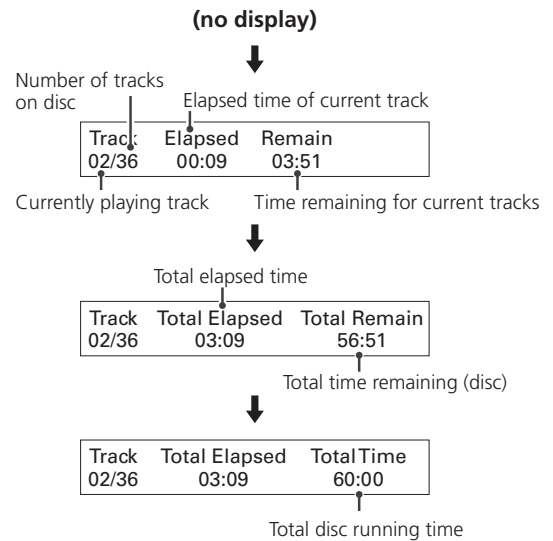

Super Audio CD/CD/video CD (stopped, on-screen display)

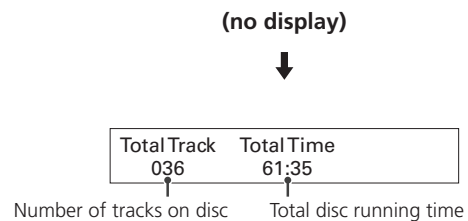

- The above does not apply to video CDs played back using the PBC system.

Setting Digital Filter, HDMI, 4% down, Word Sync and i.LINK (1)

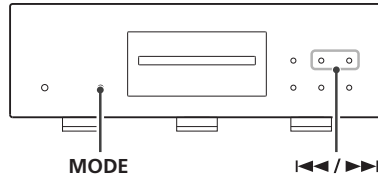

1 When playback is stopped, repeatedly press the MODE button to select the menu item to be changed.

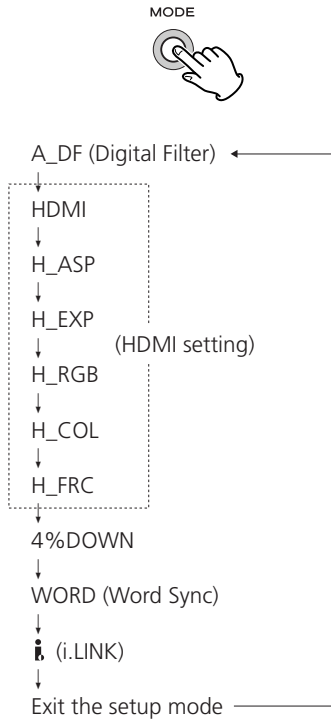

- If you leave the unit idle for 10 seconds, the setting mode will be cancelled.

2 Use the SKIP buttons (I<=</>/>=>I) to select the options within the menu item.



Individual menu functions are described on pages 31-33.

3 Repeatedly press the MODE button until the display returns normal (or leave the unit idle for 10 seconds) to exit the setup mode.

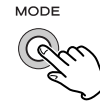

Pressing the STOP button also finishes the setup mode.

- Switching off the power without exiting the setup mode may cause problems. Do not turn the unit off.
- Settings are stored even when power is turned off and the unit is unplugged.

A_DF (Digital Filter)

Turns on or off the digital filter.

ON

Upconverts the signal up to 8x before D/A conversion. This setting produces a crisp sound with a solid feel.

OFF

Does not upconvert the signal. This setting produces a rich and natural sound.

HDMI (HDMI video output format)

Selects an HDMI video output format.

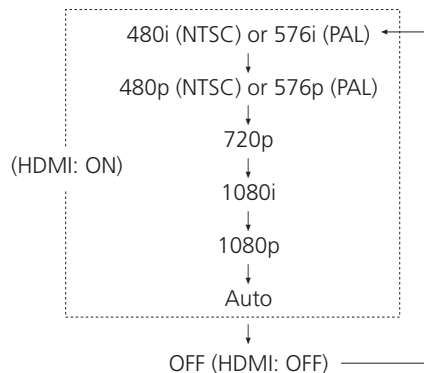

(i=interlaced, p=progressive scan)

Select "Auto" when the unit is connected to a device with an HDMI terminal. The format recommended by the receiving side is automatically selected.

The format is automatically set to "1080p" when "Auto" is selected and when the unit is connected to a device using an HDMI-DVI conversion cable.

- When this HDMI output is turned on, even if progressive scan has been selected for the component video outputs, an interlaced signal is output from the COMPONENT VIDEO terminals.
- You can use the HDMI button on the remote control unit to turn ON (the currently selected format) or OFF the HDMI video output.

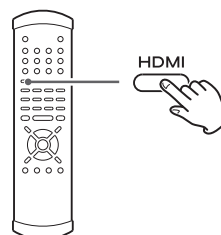

- You can also use the remote control unit to change the setting.
Press the HDMI button to turn the HDMI video output ON. While the front panel's display shows "HDMI>", use the cursor button (up or down) to change the setting.

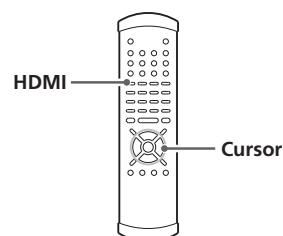

H_ASP (HDMI aspect ratio)

Selects an aspect ratio for HDMI output. Choose "AUTO", "4:3" or "FULL" to match your television (monitor).

Normally, select "AUTO". The setting is automatically switched to "FULL" or "4:3" in accordance with the data recorded on the disc in use. Note, however, that this automatic switching may not correctly occur depending on discs. If this is the case, manually select "FULL" or "4:3".

It may sometimes be necessary to change the aspect ratio when 4:3 images are distorted, especially when 720p or 1080i is selected. Use the television (monitor) controls to change the aspect ratio.

If your television (monitor) cannot change the aspect ratio, change the HDMI aspect ratio of the UX-1 Pi/UX-3 Pi to "4:3".

- You can also use the remote control unit to change the setting.
Press the HDMI button to turn the HDMI video output ON. While the front panel's display shows "HDMI>", use the cursor button (left) to change the setting.

H_EXP (HDMI expand)

Selects HDMI level. Choose either "EXP (Expand)" or "NORM (Normal)".

If the black areas shown on the monitor aren't dark enough, select "EXP".

- You can also use the remote control unit to change the setting.
Press the HDMI button to turn the HDMI video output ON. While the front panel's display shows "HDMI>", use the cursor button (right) to change the setting.

H_RGB

Selects a video signal output from the HDMI terminal. Choose either "RGB" or "YCbCr".

- When units not supporting YCbCr are connected with an HDMI cable, or when units are connected with an HDMI-DVI conversion cable, RGB is automatically output even when YCbCr is selected.

H_COL

Selects color depths of HDMI output. Choose either "10bi (10bit)" or "8bit".

If the connected equipment is not 10-bit capable, the HDMI output is at 8-bit depth even when "10bi" is selected.

H_FRC (HDMI Frame Rate Converter)

This function converts the frame rate of DVD-Video discs. Normally select "NORM".

Select "72Hz" only when the device connected to the HDMI terminal supports the vertical frequency of 72Hz or 75Hz. The vertical frequency of 480p/576p, 720p and 1080i will be converted to 72Hz (NTSC) or 75Hz (PAL).

Filmed movies were originally created at 24 frames per second and, when selecting "72Hz" (a multiple of 24) for them, motions in the images may look properly movie-ish.

If the device connected to the HDMI terminal does not support 72 Hz nor 75 Hz, select "NORM".

4%DOWN

Turns on or off the 4% down mode.

PAL DVD discs are usually played back at 25 frames per second while filmed movies on them were originally created at 24 frames per second. So when playing back PAL DVD discs without dealing with this discrepancy in frame rate, sound will be heard at a higher pitch than it was recorded at.

The 4% down mode is especially designed to reduce the playback speed of PAL DVD discs by 4% so that they are played back at 24 frames per second. Note, however, that not all devices can correctly handle digital audio and video signals sent out in 4% down mode.

- The 4% down mode is effective only when playing back PAL DVD discs.
- When turning on the 4% down mode, the ring surrounding the MODE button is lit orange. The ring is lit purple when the 4% down mode and the Word sync feature are both switched on.
- To switch on the 4% down mode is to switch off both S-Video and Video outputs.
- To achieve word sync in 4% down mode, apply a clock 4% lower than is normally the case. (When connection is made with Esoteric G-0/G-0s, select "PAL FILM" mode.)
- When played back in 4% down mode, the sound pitch is lowered.

WORD (Word sync)

Use this feature to lock your entire system to a single sync signal (clock) by connecting this unit to the Esoteric G-0s or similar device that outputs a sync signal.

"ON" or "OFF" are available.

- This unit is ready for the following clocks and switches itself depending on an incoming signal:

44.1kHz, 48kHz, 88.2kHz, 96kHz, 176.4kHz, 192kHz
This unit also accepts a Universal Clock frequency of 100 kHz.

- Make connections to the WORD SYNC terminal before turning on the unit.
- When the unit is synchronizing to the sync signal, the ring surrounding the MODE button flashes. When it is locked, the ring lights.

i.LINK

Used to select an i.LINK output setting.

When using the i.LINK terminal, select "60958" or "PCM", and set the Digital Output setting to "ON".

60958

When the disc is DVD-video/VCD/CD, the digital signal is output in the format (Stream or PCM) you set in the Audio Digital Out (see page 43).

- DSD signal is output during playback of a Super Audio CD, and linear PCM digital signal during playback of a DVD-Audio disc.

PCM

Linear PCM digital signal is output when the disc is DVD-video/VCD/CD.

Dolby Digital/DTS/MPEG signals are converted into linear PCM.

When the i.LINK (AUDIO) terminal is connected to a component without a Dolby Digital/DTS/MPEG decoder, select "PCM".

- Some amplifiers may regard this signal as DVD-Audio.
- DSD signal is output during playback of a Super Audio CD, and linear PCM digital signal during playback of a DVD-Audio disc.

OFF

Select this when you don't use the i.LINK (AUDIO) terminal. No signal is output from the i.LINK (AUDIO) terminal.

- There is no difference between 60958 and PCM as far as Super Audio CD playback is concerned.
- In case you experience any problem with the audio output, read the instructions of the connected component to check the adaptable format.
- If the component connected via the i.LINK terminal is compatible with the flow rate control, the connected component will work in the flow rate control mode.
- If the component connected via the i.LINK terminal is compatible with the flow rate control, the connected component will work in the flow rate control mode. During playback of a video source, the flow status of the UX-1 Pi/UX-3 Pi is automatically set to OFF to keep the synchronization of audio and video.

Settings (introduction)

1 Turn on the main unit, and the television (monitor).

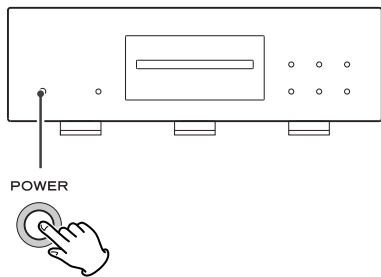

2 Press the SETUP button.

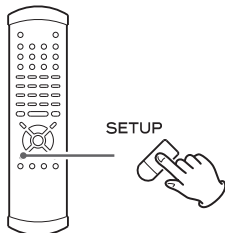

The following appears on screen.

Factory settings are marked with an asterisk "**".

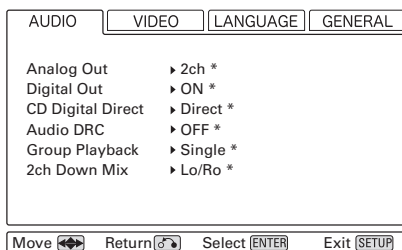

- Exit the setup mode by pressing SETUP once again.
- Although it is possible to enter the setup screen while playback is continuing (or in resume mode), not all menu functions will be available. Expand the number of available functions by pressing the STOP button twice.

3 Use the cursor buttons to navigate the menus.

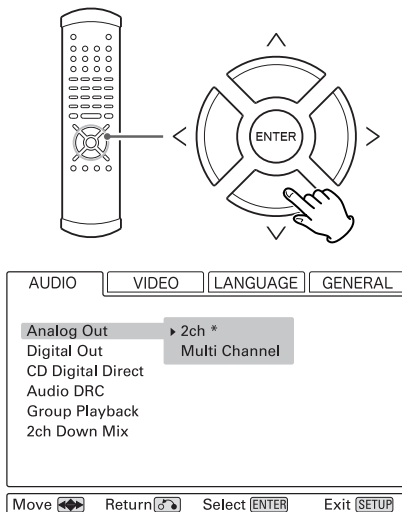

If no cursor is visible on the screen, using the left and right buttons changes between the top tabbed menus.

Use the up and down buttons to highlight menu items within these tabbed menus. RETURN returns to the top level.

4 Enter the menu item with the right cursor button.

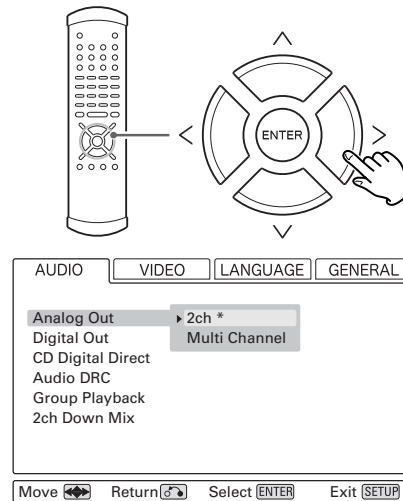

5 Use the up and down cursor buttons to select the options within the menu item, and ENTER to confirm the entry.

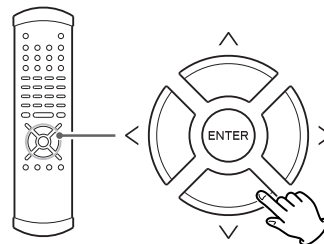

Individual menu functions are described on pages 35 through 47.

Repeat steps 3 through 5 as required.

6 Exit the setup mode by pressing SETUP once more.

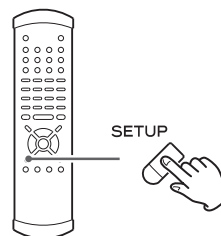

The display on the main menu also gives some menu messages and allows settings to be made, but it is easier to use the on-screen display to make these settings (remember that video output must be turned on!).

Analog output settings

[AUDIO → Analog Out]

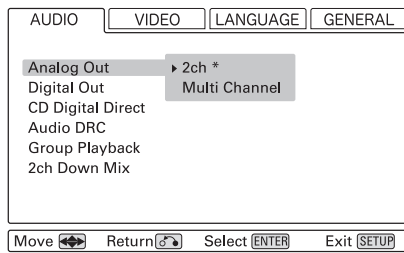

2ch

Outputs 2-channel audio from the 2-channel AUDIO OUT (FRONT), the i.LINK (AUDIO)* and the HDMI** terminals. If multi-channel program material is played, the multi-channel material will be downmixed to two channels and the DOWN MIX indicator will light on the display.

Multi Channel

The unit outputs the 5.1-channel surround sound from the 5.1-channel AUDIO OUT (UX-1 Pi only), the i.LINK (AUDIO)* and the HDMI** terminals. Select this when the unit is connected to a surround amplifier. The MULTI indicator will light on the display.

*: Only when "i.LINK" is set to "PCM" (see page 33).

** : Only when "Audio Digital Out" settings are all set to "PCM" (see page 43).

- Note that if "Multi Channel" is selected, only the front L/R sound of the multi-channel material will be output from the 2-channel AUDIO OUT (FRONT) terminals.
- Note that the audio volume changes when the mode is changed between 2-channel to multi-channel.
- Note that some DVD discs cannot be downmixed (from multi channel to 2-channel).
- Speakers should be set up properly for multi-channel use. See pages 41-43 for details.
- Note that if "Multi Channel" is selected and if the connected HDMI component cannot accept multi-channel sound, only the front L/R sound of the multi-channel material will be output from the HDMI terminal.
- You can also use the 2CH/MULTI button of the remote control unit to select either "2ch" or "Multi Channel". When playback is stopped, press the 2CH/MULTI button.

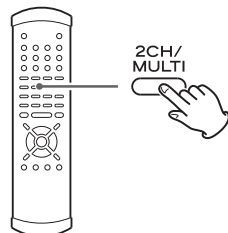

Digital output settings

[AUDIO → Digital Out]

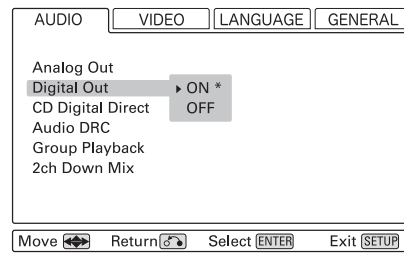

ON

Audio is output from the DIGITAL OUT, the i.LINK (AUDIO) and the HDMI terminals.

OFF

Audio is not output from the DIGITAL OUT, the i.LINK (AUDIO) and the HDMI terminals. If you are not using these terminals, we suggest that you use this OFF setting to reduce influence on the analog sound.

CD Digital Direct

[AUDIO → CD Digital Direct]

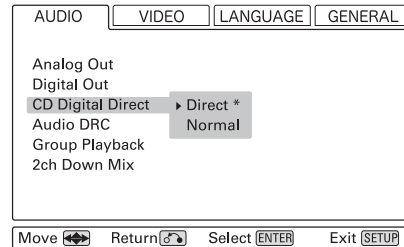

Direct

This setting bypasses unnecessary circuitry and provides better sound quality when listening to audio CDs.

Normal

When playing back DTS-CDs (DTS digital surround), select this setting.

Audio DRC (Dynamic Range Control)

[AUDIO → Audio DRC]

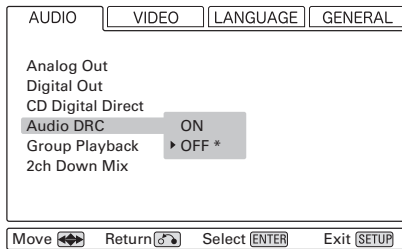

ON

Applies dynamic range control to Dolby Digital material, reducing the volume of loud sounds, and increasing the volume of quiet ones. This is useful for spoken word material, etc. as well as nighttime listening.

OFF

Turns off the audio dynamic compression.

- The overall effect of this setting depends on many things: the disc being played, the amplifier, and the speakers used for reproduction.

Group playback mode (DVD audio)

[AUDIO → Group Playback]

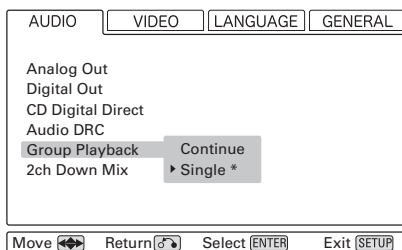

Continue

Plays all groups. Moving between groups is not possible when the menu screen is displayed.

Single

Plays the group selected using the menu. Fast forward, track skip, etc. cannot be used to move between groups.

Downmix

[AUDIO → 2ch Down Mix]

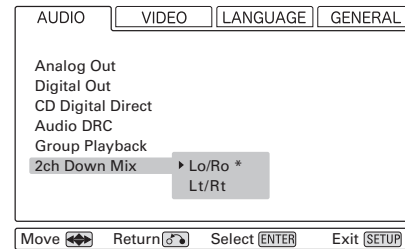

Lo/Ro

Usual stereo mode. Use this for stereo playback, etc.

Lt/Rt

This mode is useful when recording multi-channel sound on a cassette tape deck or CD recorder connected via the AUDIO OUT jacks. With a Dolby Pro Logic decoder, the recorded sound can be decoded into multi-channel sound.

- To downmix multi-channel sound, set the Analog Out setting to "2ch"
- Note that this setting is ignored for DVD audio discs and Super Audio CDs; these are downmixed in the Lo/Ro mode automatically.

Video adjustment

[VIDEO → Video Adjust]

- 1 Highlight the Video Adjust menu item and press the ENTER button.

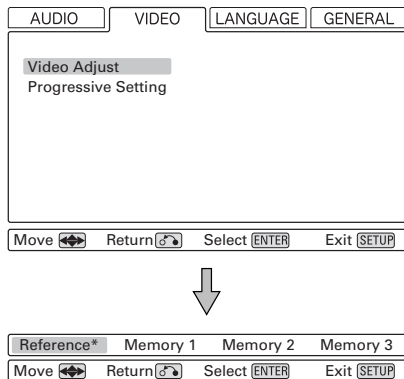

Near the bottom of the display, a row of four options appears: Reference, and three memory settings (Reference contains the factory default settings and the three memories can be used to make video settings for different monitors, types of program material, etc.). Usually, you will not need to change these settings, but there may be occasions when you want to alter one or two parameters for a perfect picture.

- 2 To change settings, use the left and right cursor buttons to highlight one of the Memory settings, and press ENTER.

- Selecting the Reference setting returns you to the VIDEO menu.

- 3 Use the up and down buttons to select the parameter, and the left and right buttons to change the value.

Sharpness

Adjusts the sharpness of the picture shown on the monitor.

Contrast

Adjusts the picture contrast.

Brightness

Adjusts the brightness of the picture.

Gamma

Adjusts the gamma value of the picture.

Hue

Adjusts the green/red balance of the picture (only for progressive-scan pictures and S-Video/Video output).

Chroma Level

Adjusts the chroma level of the picture.

Chroma Delay

Sets the delay between the Y and C signals (only affects progressive-scan pictures).

Black Setup

Use this to enhance the black level of the picture, to assist in the "3D look" of some scenes. Normally, this setting should be 0 IRE. Change it only if really necessary.

NR (Noise Reduction)

Reduces noise from the picture (only affects progressive-scan pictures).

- "Sharpness" and "Gamma" settings have effects only on interlaced-scan pictures. Note, however, that their settings have no effect on the pictures output from the HDMI terminal.

- 4 Press RETURN when done, to return to the memory selection screen, or SETUP to exit the setup menu completely.

- You can use the PICTURE button of the remote control unit to select Reference, Memory 1, Memory 2 or Memory 3.

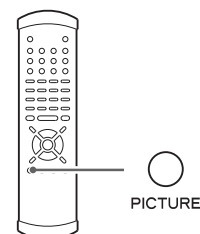

Settings (Video)

Progressive scan setting

[VIDEO → Progressive Setting → Progressive Mode]

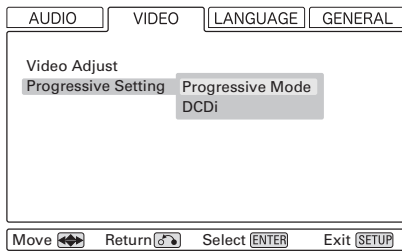

This setup is necessary only when the HDMI, the COMPONENT or the D1/D2 terminals are connected to a TV (or monitor) compatible with progressive-scan.

Within Progressive Mode, there are two settings: Auto and Video. Use the left and right cursor buttons to select these choices, and press the ENTER button. Typically, the Auto setting should be used but in the case of jagged or blurred playback of a DVD, you may want to select the Video option.

A note on progressive-scan

The video on DVD discs may be either originally shot on video or film. Video material has a frame rate of 30 fps (NTSC) while film is at 24 frames per second. In progressive-scan mode, film material is converted to 60 frames per second, and the player adjust the picture match the quality from a cinema screen. As mentioned above, Auto is the usual setting for Progressive Mode, but Video may be used if the picture appears jagged.

DCDi

[VIDEO → Progressive Setting → DCDi]

This setup is necessary only when the HDMI, the COMPONENT or the D1/D2 terminals are connected to a TV (or monitor) compatible with progressive-scan.

The DCDi circuit, which smoothes edges in the process of converting images from DVD discs into progressive-scan images and promises a natural image projection, has three settings: ON, OFF and AUTO. Use the left and right cursor buttons to select these choices, and press the ENTER button. The DCDi circuit is typically effective for video material.

Try setting the DCDi circuit to ON when diagonal lines appear jagged on playing back video material through progressive scan. With film material also, there are occasions when the ON setting produces better images in terms of smoothness and depth.

At the AUTO setting, the DCDi circuit detects whether the source is video or film and switches itself between ON and OFF accordingly. Please note, however, that this auto switching does not always work as expected depending on discs.

Settings (Language)

Audio language selection

[LANGUAGE → Audio Language]

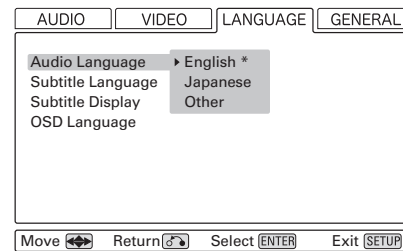

This provides an alternative to the AUDIO button for selecting alternative soundtracks. The default setting is English but you can also select Japanese, or a number of other different languages as the audio track to be played from a multi-lingual disc.

To select a language other than English or Japanese, move the cursor to "Other" and press ENTER.

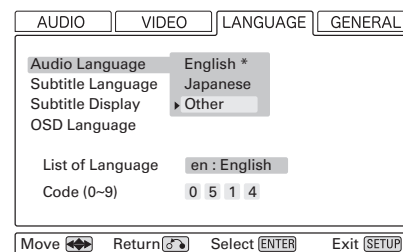

If you select the List of Language field, you see a list of ten relatively common languages. Select from this list by moving the cursor and pressing ENTER.

If the language you want is not listed here, but is listed on page 40, move the cursor to the Code (0-9) field (all numbers are reset as dashes) and use the number buttons to enter the four-digit code for that language. Press ENTER when done.

- If the selected language is not available on the disc, the first language of the disc is played.

Subtitle language selection

[LANGUAGE → Subtitle Language]

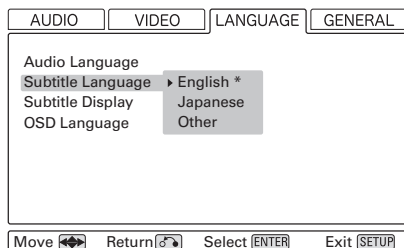

This provides an alternative to the SUBTITLE button for selecting alternative subtitle languages. The default setting is English but you can also select Japanese, or a number of other different languages for the subtitles to be displayed.

To select a language other than English or Japanese, move the cursor to Other and press ENTER.

If you select the List of Language field, you see a list of ten relatively common languages. Select from this list by moving the cursor and pressing ENTER.

If the language you want is not listed here, but is listed on page 40, move the cursor to the Code (0-9) field (all numbers are reset as dashes) and use the number buttons to enter the four-digit code for that language. Press ENTER when done.

- If the selected language is not available on the disc, the first subtitle language of the disc is used.

Displaying subtitles

[LANGUAGE → Subtitle Display]

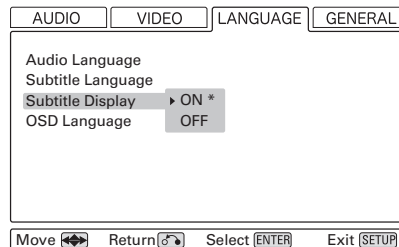

This turns subtiting ON or OFF.

Note that the captions on some disks cannot be turned off.

On-screen display language

[LANGUAGE → OSD Language]



Select an OSD language. The default setting is English.

NOTE: If the unit is set to a foreign language and you find it impossible to read the menu settings, you can restore all the factory default settings, and the menus will appear in English again (all other settings will be wiped out).

Language Code List

Language	Code
Japanese (ja)	1001
English (en)	0514
French (fr)	0618
German (de)	0405
Italian (it)	0920
Spanish (es)	0519
Chinese (zh)	2608
Dutch (nl)	1412
Portuguese (pt)	1620
Swedish (sv)	1922
Russian (ru)	1821
Korean (ko)	1115
Greek (el)	0512
Afar (aa)	0101
Abkhazian (ab)	0102
Afrikaans (af)	0106
Amharic (am)	0113
Arabic (ar)	0118
Assamese (as)	0119
Aymara (ay)	0125
Azerbaijani (az)	0126
Bashkir (ba)	0201
Byelorussian (be)	0205
Bulgarian (bg)	0207
Bihari (bh)	0208
Bislama (bi)	0209
Bengali (bn)	0214
Tibetan (bo)	0215
Breton (br)	0218
Catalan (ca)	0301
Corsican (co)	0315
Czech (cs)	0319
Welsh (cy)	0325
Danish (da)	0401
Bhutani (dz)	0426
Esperanto (eo)	0515
Estonian (et)	0520
Basque (eu)	0521
Persian (fa)	0601
Finnish (fi)	0609
Fiji (fj)	0610
Faroese (fo)	0615
Frisian (fy)	0625
Irish (ga)	0701
Scots-Gaelic (gd)	0704
Galician (gl)	0712

Language	Code
Guarani (gn)	0714
Gujarati (gu)	0721
Hausa (ha)	0801
Hindi (hi)	0809
Croatian (hr)	0818
Hungarian (hu)	0821
Armenian (hy)	0825
Interlingua (ia)	0901
Interlingue (ie)	0905
Inupiak (ik)	0911
Indonesian (in)	0914
Icelandic (is)	0919
Hebrew (iw)	0923
Yiddish (ji)	1009
Javanese (jw)	1023
Georgian (ka)	1101
Kazakh (kk)	1111
Greenlandic (kl)	1112
Cambodian (km)	1113
Kannada (kn)	1114
Kashmiri (ks)	1119
Kurdish (ku)	1121
Kirghiz (ky)	1125
Latin (la)	1201
Lingala (ln)	1214
Laothian (lo)	1215
Lithuanian (lt)	1220
Latvian (lv)	1222
Malagasy (mg)	1307
Maori (mi)	1309
Macedonian (mk)	1311
Malayalam (ml)	1312
Mongolian (mn)	1314
Moldavian (mo)	1315
Marathi (mr)	1318
Malay (ms)	1319
Maltese (mt)	1320
Burmese (my)	1325
Nauru (na)	1401
Nepali (ne)	1405
Norwegian (no)	1415
Occitan (oc)	1503
Oromo (om)	1513
Oriya (or)	1518
Panjabi (pa)	1601
Polish (pl)	1612

Language	Code
Pashto, Pushto (ps)	1619
Quechua (qu)	1721
Rhaeto-Romance (rm)	1813
Kirundi (rn)	1814
Romanian (ro)	1815
Kinyarwanda (rw)	1823
Sanskrit (sa)	1901
Sindhi (sd)	1904
Sangho (sg)	1907
Serbo-Croatian (sh)	1908
Sinhalese (si)	1909
Slovak (sk)	1911
Slovenian (sl)	1912
Samoan (sm)	1913
Shona (sn)	1914
Somali (so)	1915
Albanian (sq)	1917
Serbian (sr)	1918
Siswati (ss)	1919
Sesotho (st)	1920
Sundanese (su)	1921
Swahili (sw)	1923
Tamil (ta)	2001
Telugu (te)	2005
Tajik (tg)	2007
Thai (th)	2008
Tigrinya (ti)	2009
Turkmen (tk)	2011
Tagalog (tl)	2012
Setswana (tn)	2014
Tonga (to)	2015
Turkish (tr)	2018
Tsonga (ts)	2019
Tatar (tt)	2020
Twi (tw)	2023
Ukrainian (uk)	2111
Urdu (ur)	2118
Uzbek (uz)	2126
Vietnamese (vi)	2209
Volapük (vo)	2215
Wolof (wo)	2315
Xhosa (xh)	2408
Yoruba (yo)	2515
Zulu (zu)	2621

Use these speaker setup menus in the following cases only:

- When the 5.1-channel AUDIO OUT terminals (UX-1 Pi only) are connected to a surround sound amplifier.
- When the i.LINK (AUDIO) or the HDMI terminal is connected to a surround sound amplifier with a decoder, and when you don't use the speaker menus of the amplifier.

The speaker setup has no effect on the sound output from the DIGITAL OUT (coaxial or optical) terminals.

There is no need for this setup when not using the 5.1-channel AUDIO OUT (UX-1 Pi only), the i.LINK (AUDIO) or the HDMI terminal, or when you use the speaker menus of the amplifier. In this case, leave this setup as it is (factory settings).

- The speaker setup has effects on the sound output from the 5.1-channel AUDIO OUT (UX-1 Pi only), the i.LINK and the HDMI terminals when the Analog Out setting is set to "Multi Channel".
- In the following cases, the settings made here are ignored:
 - When the Analog Out setting is set to "2ch".
 - Play a DVD-Video with "i.LINK" set to "60958".

Speaker Size

[GENERAL → Speaker Setting → Size]

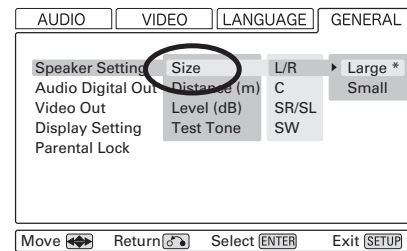

Select the size (Large or Small) independently for the L/R (front pair of speakers), the C (center speaker) and the SR/SL (surround pair of speakers). Turn the subwoofer (SW) ON or OFF (if you have no subwoofer).

Large

Select this when the connected speakers can fully reproduce bass frequencies.

Small

Select this when the connected speakers are rather small and cannot reproduce bass frequencies.

When this setting is selected, bass frequencies are output from the subwoofer (if no subwoofer is connected, from the front speakers).

OFF

Select this when no speaker is connected. The sound is output from the front (or surround) speakers.

- When the front speaker is set to "Small", the subwoofer is set to "ON" automatically. You cannot set the subwoofer "OFF".

ON (subwoofer only)

Select this when a powered subwoofer is connected.

- For the center and surround pair options, if these speakers are not physically present, you can select OFF to prevent any output from those channels (you cannot turn off the front L/R pair). Any speakers turned off will downmix (if this option is selected) to the other enabled channels.
- Turning downmix on and off may affect the overall volume.
- If necessary, adjust the level of subwoofer using the volume control of its own or the Speaker level setup (see page 42).

Speaker distance

[GENERAL → Speaker Setting → Distance]

Ideally, the speakers should be placed so that they are all the same distance from the listening position. If this is not possible, you should use this method described here to adjust them individually. It is also possible to adjust all distances together. The point of these settings is to provide the best synchronization between sound and image by delaying the sound by an appropriate amount. The subwoofer is not included in this setting (the placement of the subwoofer is less critical than that of other speakers).

- This setup has effects on all the sound output from the 5.1-channel AUDIO OUT terminals (UX-1 Pi only).
- In case of using the i.LINK (AUDIO) terminal, this setup is effective only when "i.LINK" is set to "PCM" (see page 33), and DVD Video or DVD Audio discs are played. This setup has no effect on Super Audio CD.
- In case of using the HDMI terminal, this setup is effective only when Dolby Digital, DTS and MPEG Audio of "Audio Digital Out" setting is set to "PCM" (see page 43), and DVD Video or DVD Audio discs are played. This setup has no effect on Super Audio CD.

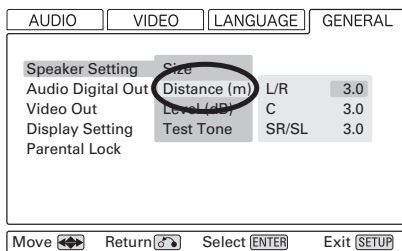

The L/R setting changes the distance of all speakers together. Pressing the up button adds 0.1m to each value, and pressing the down button subtracts 0.1m from each value. Distances are measured in meters (1 meter = just over 3 feet, and 0.1 meter = about 4 inches).

Carry out this operation first before setting the other speaker distances.

After setting the L/R, C and SR/SL speaker distances together, you can now set the center and surround pair distances. The minimum distance for these is 0m and the maximum is 9m, with the additional restrictions described here.

- The distance that you set for the center speaker cannot be greater than the distance set for the L/R pair and must be within 1.7m of that L/R distance. So for example, if the distance to the L/R pair is set to 5.0m, the center distance must be between 3.3m (5 - 1.7) and 5m.
- The distance that you set for the SR/SL surround pair cannot be greater than the distance set for the L/R pair (and must be within 9m of that distance). So with the L/R pair set at 5m, the SR/SL pair distance can be set from 0m to 5m.

Speaker levels

[GENERAL → Speaker Setting → Level]

Use this to set the relative levels of the speakers. You can set the L/R pair together, and the center, and surround rear pair independently, as well as the subwoofer. The maximum value you can set here is 0dB and the minimum is -12dB, with settings made in 0.5dB increments. The default setting is each speaker channel set to 0dB.

1. When you are ready to start, highlight the "Test Start" and press the ENTER button.

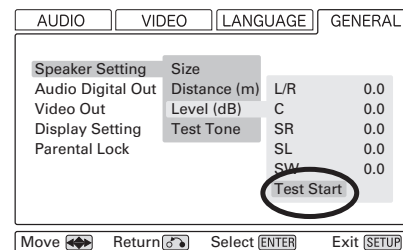

The unit outputs test tone from each channel in turn at the specified level for each channel.

- Test tone at very high levels may not be good for your speakers. Make sure the level of your system is turned down to a reasonable level before carrying out this operation.
- Test tone from subwoofer may be nearly inaudible. Check the level of subwoofer using source material containing low frequency sound.
- The unit won't output test tone when a Super Audio CD is (or had been) loaded. In this case, remove the disc, turn the unit off and on, and try again.
- The unit won't output test tone when "i.LINK" is set to "60958". Select "PCM" to output test tone (see page 33).

2. Adjust the levels and continue using the test tone as necessary until you are happy with the balance.

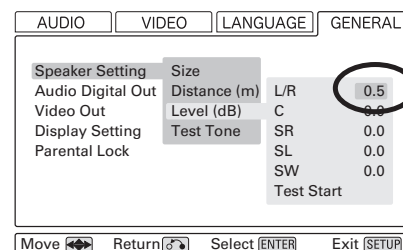

Test tone length

[GENERAL → Speaker Setting → Test Tone]

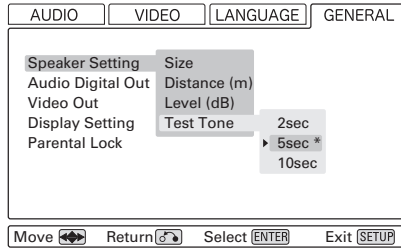

Select the Test Tone menu item, and choose between 2, 5 and 10 seconds. This represents the length of time that the test tone is output from each speaker when Test Start is selected.

Digital output formats

[GENERAL → Audio Digital Out]

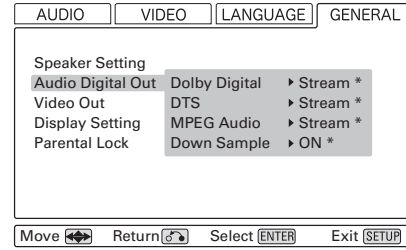

This setting has an effect on the digital signal output from the DIGITAL OUT terminals and the HDMI terminal.

When "i.LINK" is set to "60958", this setting also has an effect on the digital signal output from the i.LINK (AUDIO) terminal.

Select the format of different digital audio types for different purposes, as detailed below:

Dolby Digital

Select either "Stream" for use with Dolby Digital compatible amplifiers or "PCM" for use when connecting to a CD recorder, MD deck, etc.

DTS

Select either "Stream" for connection to a DTS-compatible amplifier, or "PCM" for use with more general equipment. Do not select the Stream option when connecting to non-DTS-compatible equipment.

MPEG Audio

Select either "Stream" for connection to an MPEG-compatible amplifier, or "PCM" for use with more general equipment.

Down Sample

Enable (ON) or disable (OFF) downsampling. That is, all digital signals are converted, and output at 48kHz or 44.1kHz. Use this if your amplifier does not have 96kHz/88.2kHz capability.

Notes on the DIGITAL OUT (coaxial or optical) terminals:

- Even when downsampling is turned off, some discs are automatically downsampled to 48kHz or 44.1kHz.
- Even when downsampling is turned off, all discs with sampling frequencies of 192kHz or 176.4kHz are always downsampled to 96kHz or 88.2kHz respectively.

Note

- When you select "Stream", your amplifier will decode the signal.
- When your amplifier is not compatible with Dolby Digital, DTS or MPEG, select "PCM".
- If you want to output multi-channel PCM signals from the HDMI terminal, set all three settings (Dolby Digital, DTS and MPEG) to "PCM", and set Analog out to "Multi channel".
- If you select "Stream" with the HDMI amplifier not compatible with Dolby Digital, DTS and MPEG, converted signal will be output from the HDMI terminal.

Settings (General/Video Out)

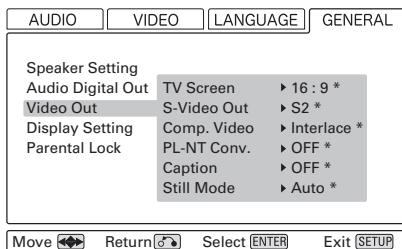

This menu item contains a number of different options, all concerned with the video output from the unit.

TV screen

[GENERAL → Video Out → TV Screen]

Because the shape of the television or monitor may not match the shape of the movie frame, you may need to change the way in which the image is displayed to avoid distortion on older televisions, which use a 4:3 aspect ratio; high-definition televisions use 16:9 (as do movies).

Note that you may need to read your television's manual in conjunction with this section in order to achieve the best results. Some discs do not allow the aspect ratio to be changed and you will therefore have to change the aspect ratio on the TV.

Make this setting while playback is stopped; you cannot do this while playing back a disc.

16:9

Use with a 16:9 wide television.



4:3 picture



16:9 picture

4:3LB (Letterbox)

This mode is used with 4:3 televisions. 4:3 images are displayed normally. 16:9 images are visible at their full width, but a blank area is left at the top and bottom of the screen.



4:3 picture



16:9 picture

4:3PS (Pan & Scan)

This mode is used with 4:3 televisions. 4:3 images are displayed normally. When showing 16:9 programs, the full height of the screen is used, but the left and right part of the image are cut off.



4:3 picture

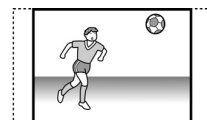

16:9 picture

S-Video output

[GENERAL → Video Out → S-Video Out]

If a television is connected using the S-Video output, the signal can be set to change the aspect ratio of the television automatically.

S1

The aspect ratio information (16:9 and 4:3) is included in the S1-Video signal.

S2

In addition to the information of S1, "4:3 Letterbox" information is included in the S2-Video signal. If your wide-screen television is compatible with S2-Video, correct aspect ratio will be selected automatically.

- If the picture is stretched or distorted, select "S1".

Component video output

[GENERAL → Video Out → Comp. Video]

This setting allows the selection of interlaced (Interlace) or progressive-scan (Progressive) video from the component video outputs (COMPONENT VIDEO and D1/D2).

Progressive-scan video provides a better, clearer picture. However, it is not supported by every television or monitor, and you should ensure that this is supported fully before turning on this option.

- When your TV isn't compatible with progressive scan, never select "Progressive". No picture will be shown on the monitor.
In case you select "Progressive" by mistake, connect your TV via the VIDEO OUT jack or S-VIDEO jack to display the Setup menu and change the setting to "Interlace", or initialize the settings (see page 7).
- This setting has no effect on the HDMI terminal. See page 31 to output progressive-scan video from the HDMI terminal.
- When this HDMI output is turned on, even if progressive scan has been selected for the component video outputs, an interlaced signal is output from the COMPONENT VIDEO and the D1/D2 terminals.

'CONSUMERS SHOULD NOTE THAT NOT ALL HIGH DEFINITION TELEVISION SETS ARE FULLY COMPATIBLE WITH THIS PRODUCT AND MAY CAUSE ARTIFACTS TO BE DISPLAYED IN THE PICTURE. IN CASE OF 525 OR 625 PROGRESSIVE SCAN PICTURE PROBLEMS, IT IS RECOMMENDED THAT THE USER SWITCH THE CONNECTION TO THE 'STANDARD DEFINITION' OUTPUT. IF THERE ARE QUESTIONS REGARDING OUR TV SET COMPATIBILITY WITH THIS MODEL 525p AND 625p DVD PLAYER, PLEASE CONTACT OUR CUSTOMER SERVICE CENTER.'

PAL-NTSC conversion

[GENERAL → Video Out → PL-NT Conv.]

This allows you to play back and show NTSC discs on PAL equipment, or the other way round. There are three options:

OFF

PAL discs can only be shown on PAL equipment, and NTSC discs can only be shown on NTSC equipment. Use this setting to produce the best possible picture, by playing each type of disc on the appropriate equipment.

PAL>NTSC

PAL discs can be displayed on NTSC equipment. The bottom part of the picture is cut off, and the height is elongated.

NTSC>PAL

NTSC discs can be played back on PAL equipment. The height of the picture is reduced.

If the connected TV does not support PAL (or NTSC), do not select "NTSC>PAL" (or "PAL>NTSC") or setting screens could not be accessed. If this is the case, restore factory settings (see page 7).

- To enjoy the original picture as it is, set the PAL-NTSC conversion setting to "OFF" and use TVs that are appropriate for each type of disc.
- Since the number of frames per second is different between PAL and NTSC standards, moving images, when converted between the two standards, may not look the same as their original.

Closed captioning

[GENERAL → Video Out → Caption]

The unit can play back DVD discs which include closed captioning information and show the closed captions (on a suitably-equipped television).

Turn this function either ON or OFF.

Still mode

[GENERAL → Video Out → Still Mode]

There are three options to enable different still modes for DVD, depending on whether a movie or other type of video is being played back. This setting determines the clearest still picture obtained when the DVD playback is paused.

Auto

Automatically chooses between field and frame modes.

Field

Usually provides a sharp still picture. But depending on the disc, the image might be shaky even when "Field" is selected.

Frame

Usually provides a better still picture with movie DVDs.

With video DVDs, the picture may be blurred when playback is paused.

Settings (General/Display)

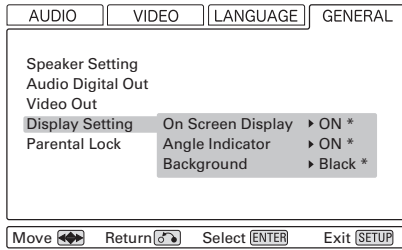

On-screen display

[GENERAL → Display Setting → On Screen Display]

When a button is pressed and this setting is ON, the screen shows that button's name and/or icon, etc. Turn this OFF if you do not need this kind of on-screen display.

Angle indication

[GENERAL → Display Setting → Angle Indicator]

For discs which support different angles (see page 25), this allows the angle indicator mark to be displayed (ON) or not (OFF) when an alternative angle is available on the section of the disc being played back.

Background color

[GENERAL → Display Setting → Background]

When the disc is stopped, this sets the background color of the screen. Choose between Black, Gray and Blue.

Parental Control

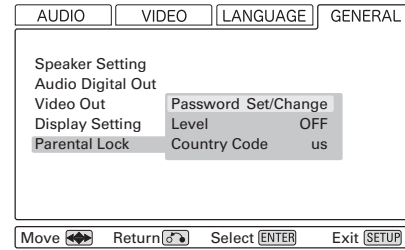

It is possible to protect the playback of discs containing material unsuitable for viewing by children which parents do not wish their children to view, as DVD discs can contain information regarding their suitability for children recorded on them. Such levels may vary from country to country, and this unit allows such variable restrictions.

Before a disc protected in this way can be played back on the unit, it is necessary to enter a password which temporarily changes the level to a more "relaxed" value.

These different levels of protection also allow you to change the levels of protection as your children grow up, for example.

NOTE: If the user settings are reset, the password (and hence parental control) is disabled.

Setting the password

[GENERAL → Parental Lock → Password Set/Change]

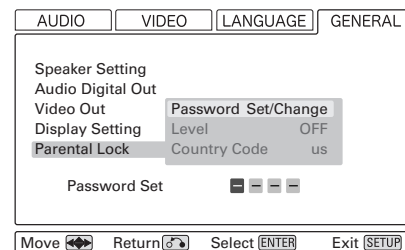

The first time that you use the unit (or the first time that you use the unit after resetting to factory settings), other parental lock options are disabled. All you can do is enter a 4-digit password using the number buttons on the remote control unit.

Enter this number (and remember it!), as you will need it to change the level of control in the future as well as to temporarily unlock discs for playback.

Setting the level of control

[GENERAL → Parental Lock → Level]

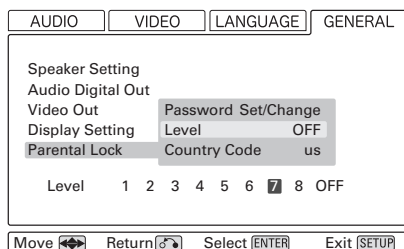

Once a password has been entered, you can enter a control level, ranging from 1 (strict control) through 8 (much less strict) to OFF (no control at all).

When Level is selected, you must make the selection within 30 seconds. Press ENTER to confirm the setting.

Country Code

[GENERAL → Parental Lock → Country Code]

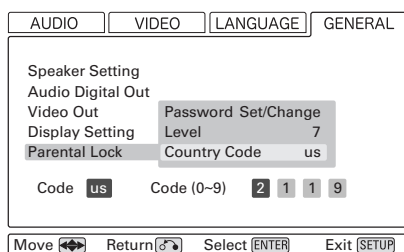

As well as the level, you can change the country to which the level applies. Select the Country code option, enter the 4-digit country code and press ENTER. The two-letter country code changes.

Playing a controlled disc

If you then attempt to play a disc whose level is greater than the level you have set, the disc shows a screen which explains that the disc cannot be played with this level of control. Following the on-screen instructions, you will be prompted to turn off the level, temporarily while the disc is being played. Enter the 4-digit password, and then press ENTER. The disc can then be played.

If you eject the disc or turn off the unit with the disc inserted, the password to play back the disc is "forgotten" by the unit. To play the disc again, you must enter the password again.

Resetting the password

You can reset the password at any time. Choose the Password Set/Change option, enter the old password and then enter the new password (number buttons).

Country	Input Code	Country Code
ARGENTINA	0118	ar
AUSTRALIA	0121	au
AUSTRIA	0120	at
BELGIUM	0205	be
BRAZIL	0218	br
CANADA	0301	ca
CHILE	0312	cl
CHINA	0314	cn
DENMARK	0411	dk
FINLAND	0609	fi
FRANCE	0618	fr
GERMANY	0405	de
HONG KONG	0811	hk
INDIA	0914	in
INDONESIA	0904	id
ITALY	0920	it
JAPAN	1016	jp
KOREA, REPUBLIC OF	1118	kr
MALAYSIA	1325	my
MEXICO	1324	mx
NETHERLANDS	1412	nl
NEW ZEALAND	1426	nz
NORWAY	1415	no
PAKISTAN	1611	pk
PHILIPPINES	1608	ph
PORTUGAL	1620	pt
RUSSIAN FEDERATION	1821	ru
SINGAPORE	1907	sg
SPAIN	0519	es
SWITZERLAND	0308	ch
SWEDEN	1905	se
TAIWAN, PROVINCE OF CHINA	2023	tw
THAILAND	2008	th
UNITED KINGDOM	0702	gb
UNITED STATES OF AMERICA	2119	us

In case you experience any problem with this unit, please take the time to look through this chart and see if you can solve the problem yourself before you call your dealer.

General

No power

- Check the connection to the AC power supply. Check and make sure the AC source is not a switched outlet and that, if it is, the switch is turned on. Make sure there is power to the AC outlet by plugging another item such as a lamp or fan.
- Press the POWER button of the main unit to turn it on.

Remote control doesn't work.

- Press the POWER button of the main unit to turn it on.
- If the batteries are dead, change the batteries.
- Use remote control unit within the range (7m/23ft) and point at the front panel.
- Clear obstacles between the remote control unit and the main unit.
- If a strong light is near the unit, turn it off.

Other units with remote controls operate incorrectly.

- Note that other units with remote controls may operate incorrectly because of infrared light "overspill" when you operate the remote control unit.

Will not play.

- Reload the disc with the label side UP.
- This unit cannot play such discs as CD-ROMs. Use a playable disc (see page 8).
- If the disc is dirty, clean the surface of the disc.
- A blank disc has been loaded. Load a prerecorded disc.
- Check the region code of the DVD (see page 8).
- If the unit is condensed, leave the unit for one or two hours with the power turned on (see page 6).

PROHIBIT mark "⊘" appears on the screen.

- The operation is not permitted by the disc or the unit.
- Note that during playback of a title part (cautions, software maker's logo, etc.), most operations are prohibited by the disc.
- If another operation is still in process, wait a moment and try again.

Cannot access some setup menu items.

- Although it is possible to enter the setup screen while playback is continuing (or in resume mode), not all menu functions will be available. Expand the number of available functions by pressing the STOP button twice (see page 34).

Scanning stops.

- Scanning does not work within menus.

There is no sound or only a very low-level sound is heard.

- Check that the amplifier and speakers are connected securely.
- Check the operation of the amplifier.
- The required settings must be made depending on the terminals used. Check for the correct settings (see pages 10-14).
- The sound is muted during pause, slow-motion, fast forward/reverse, and stepping playback. Press the PLAY button to resume normal playback.

Audio

No 5.1-channel audio output.

- Set the Analog Output setting to "Multi Channel" (see page 35).
- Change the speaker configuration if necessary (see page 41).
- For digital multi-channel output, you must use a surround amplifier, and set the Audio Digital Out settings to "Stream" (see page 43).
- Super Audio CD and DVD audio discs may have more than one group or playback area, not all of which contain multi-channel audio data. Choose another group or playback area (see page 22).

Overall volume is low, or balance between speakers is strange.

- A speaker's level (or that of a pair of speakers) has been set up too low or too high in the speaker setup. Correct the levels (see page 42).
- When the unit is downmixing multi-channel audio, the volume differs from the non-downmixed level. Use the amplifier to adjust the volume.
- When configuring speaker sizes, making "small" and "off" settings on speakers other than the subwoofer can affect the subwoofer volume. Adjust the level on the subwoofer itself (see page 41).

No digital audio output.

- Check that the Digital Out setting is set to "ON" (see page 35).
- Some DVD-Audio discs prohibit digital audio output.
- Digital audio from a Super Audio CD cannot be output from the HDMI and the DIGITAL OUT (OPTICAL or COAXIAL) terminals. Use the i.LINK (AUDIO) terminal.
- No digital audio is output from the DIGITAL OUT terminals when playing DVD-Audio in multi-channel (other than Dolby Digital or DTS).

Digital audio recording is not possible on another device.

- Check that the Digital Out setting is set to "ON". And the digital output format must be set to "PCM" (see pages 35, 43). Set the Analog Output setting to "2ch" (see page 35).
- Copy-prohibit material cannot be copied digitally.

Cannot output 96kHz or 88.2kHz digital audio.

- ➔ Check that the Audio Digital Out setting is set to "Down Sample OFF" (see page 43).
- ➔ Some copy protected discs do not output high sampling rate digital audio.

No DTS audio output.

- ➔ When your amplifier is not equipped with DTS decoder, set the DTS setting to "PCM". Or press the AUDIO button to select any other audio (see pages 43, 24).
- ➔ When playing back a DTS-CD, set the CD Digital Direct setting to "Normal" (see page 35).
- ➔ Check the setting of your amplifier.

Noticeable difference in DVD, CD and Super Audio CD's volume.

- ➔ That is because DVDs, CDs and Super Audio CDs use different recording methods.

Video**No picture/distorted picture**

- ➔ Check the connection to the television (monitor)
- ➔ Check the operating instructions for the television (monitor) to make sure that you have the right input selected, etc.
- ➔ Use the VIDEO OFF button of the remote control unit to turn the video on (see page 27).
- ➔ If you are using a HDMI connection, make sure it is configured correctly (see pages 11, 31-32).
- ➔ If you are using a component or D1/D2 connection, make sure it is configured correctly (see page 11).
- ➔ When your television/monitor isn't compatible with Progressive scan, never set the Component Video setting to "Progressive" (see page 45).
- ➔ If the PAL-NTSC setting is wrongly set, the picture may be distorted. Try then to restore factory setting (see pages 45, 7).

Picture noise.

- ➔ If video from this system has to go through your VCR to get to your TV, the copy-protection applied to some DVD programs could affect picture quality. Please connect the unit directly to your TV.

The image is distorted or monochromatic.

- ➔ The color system selected does not match your TV (see page 6).
- ➔ Adjust the aspect ratio to correspond to the television/monitor in use (see page 44).
- ➔ If using an S1/S2 S-Video connection, you may need to set the output signal to "S1" (see page 44).

The aspect ratio of the screen cannot be changed.

- ➔ The aspect ratio might be fixed by the disc.

Screen is suddenly stretched when the Setup screen is opened.

- ➔ If the Setup screen is opened during playback of a DVD being viewed in the letter box format, the screen may switch to the wide screen format. This is not a malfunction. The screen will return to normal when the Setup screen is closed.

DISPLAY button doesn't work.**No message appear on the screen.**

- ➔ Set the On Screen Display option to "ON" (see page 46).

ANGLE mark doesn't appear on the screen.

- ➔ Set both the Angle Indicator option and the On Screen Display option to "ON" (see page 46).

Picture and sound don't match up.

- ➔ Use the lip sync feature to adjust the relative timing of picture and audio (see page 26).

Word Sync**The MODE button blinks, and the display shows "No Word!"**

- ➔ The word sync mode is selected, but there is no clock source. Turn the word sync mode off (see page 33).
- ➔ No word clock is being received. Check cables, connections, and settings of the clock generator.

The MODE button blinks, and the display shows "WRD UNLCK!"

- ➔ Invalid word sync signal is received. Check the setting of the clock generator.

If normal operation cannot be obtained, unplug the power cord from the outlet and plug it again. This resets the internal micro-computer which can be disturbed during electrical storms, power interruptions, et cetera.

The i.LINK is also known as IEEE 1394, an international specification.

This unit is ready for i.LINK (AUDIO).

By connecting an i.LINK (AUDIO)-capable device to the i.LINK (AUDIO) (or IEEE 1394) terminal on this unit using an i.LINK cable, you can transmit Super Audio CD multi-channel signals that could not be transmitted but in analog format in the past can be transmitted in its original digital format, in addition to the capability of transmitting 2-ch linear PCM data and multi-channel compressed audio signals.

If you have multiple i.LINK-capable devices, you can connect them through other devices to transmit data between them, so you don't need to be concerned with the order of connection.

Copyright protection system DTCP

To play back audio sounds recorded on Super Audio CD or DVD discs using i.LINK, both the player and the D/A converter need to be ready for the copyright protection system DTCP (Digital Transmission Content Protection).

This unit is ready for DTCP.

Data transfer rate

There are three transfer rates: 100 Mbps (S100), 200 Mbps (S200), and 400 Mbps (S400). This unit is capable of transferring data at a maximum 400Mbps.

For connection to an i.LINK-capable device, use a commercially available S400-compliant 6-pin i.LINK cable.

When connecting multiple i.LINK-capable devices, avoid connecting a device having slow transfer rate between devices having high transfer rate since this reduces the transfer rate of your whole system. Connect devices having high transfer rate towards the source as far upstream as possible.

NOTES

- Among the i.LINK formats there are "MPEG-2 TS" for BS digital source and "DV" for digital video for DVD recorders, as well as the "i.LINK (AUDIO)" (A&M Protocol). Never connect devices that are not ready for i.LINK (AUDIO) to this unit. If you do, this unit and others may get out of order or be damaged.
- In the process of data transfer, avoid plugging/unplugging the i.LINK cables in use or switch on/off the power.
- Among the i.LINK-capable devices there are some that, if not turned on, are not capable of relaying data.
- Chances are some i.LINK-capable devices will not respond to this unit's command.

How to connect multiple i.LINK-capable devices

Daisy chain connection

You can daisy-chain up to 17 devices including this unit.

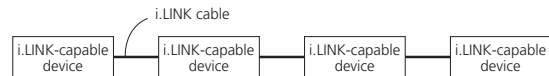

Connection in tree structure

If you are using a device having three or more i.LINK connectors, you may want to get the connection branched out. This way of connection allows you to connect up to 17 devices including this unit.

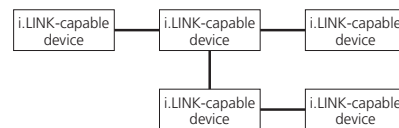

Your system does not work if data is fed back to the output device. Be careful not to create a loop.

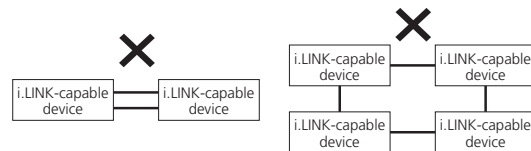

The i.LINK interface of this unit is designed in accordance with the following specifications:

- 1) IEEE Std 1394a-2000, Standard for a High Performance Serial Bus
- 2) Audio and Music Data Transmission Protocol 2.0

This unit is compliant with IEC 60958 bitstream, DVD-Audio, Super Audio CD in the AM824 sequence adaptation layers of this protocol.

Free Manuals Download Website

<http://myh66.com>

<http://usermanuals.us>

<http://www.somanuals.com>

<http://www.4manuals.cc>

<http://www.manual-lib.com>

<http://www.404manual.com>

<http://www.luxmanual.com>

<http://aubethermostatmanual.com>

Golf course search by state

<http://golfingnear.com>

Email search by domain

<http://emailbydomain.com>

Auto manuals search

<http://auto.somanuals.com>

TV manuals search

<http://tv.somanuals.com>