

# Installation Instructions

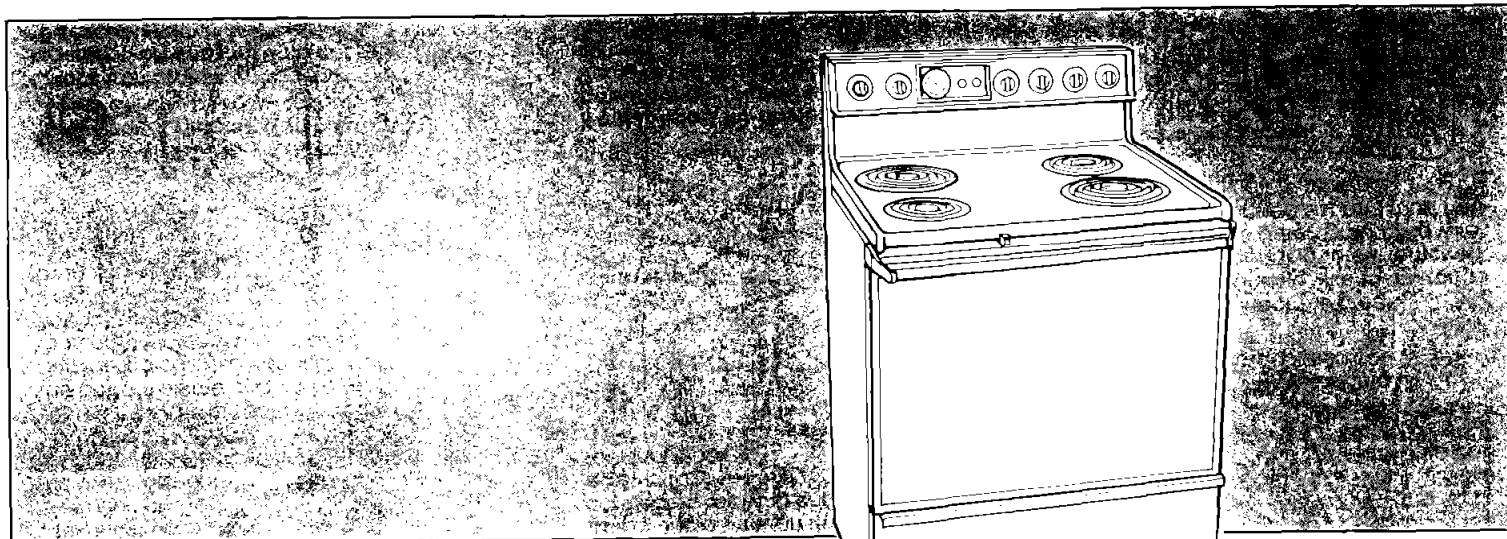

Part No. 3150250

## 30" Electric Freestanding Range

**IMPORTANT**

**Installer:** Leave Installation Instructions with the homeowner.

**Homeowner:** Keep Installation Instructions for future reference.

**Save** Installation Instructions for local inspector's use.

**Estate**  
APPLIANCES

## Before you start...

Proper installation is your responsibility. A qualified technician should install this range. Make sure you have everything necessary for correct installation. It is the responsibility of the installer to comply with the installation clearance specified on the serial/rating plate. The serial/rating plate is located on the oven frame behind the door.

**Important:**  
Observe all governing codes and ordinances.

Check location where range will be installed. The range should be located for convenient use in kitchen.

ALL OPENINGS IN THE WALL OR FLOOR WHERE RANGE IS TO BE INSTALLED MUST BE SEALED

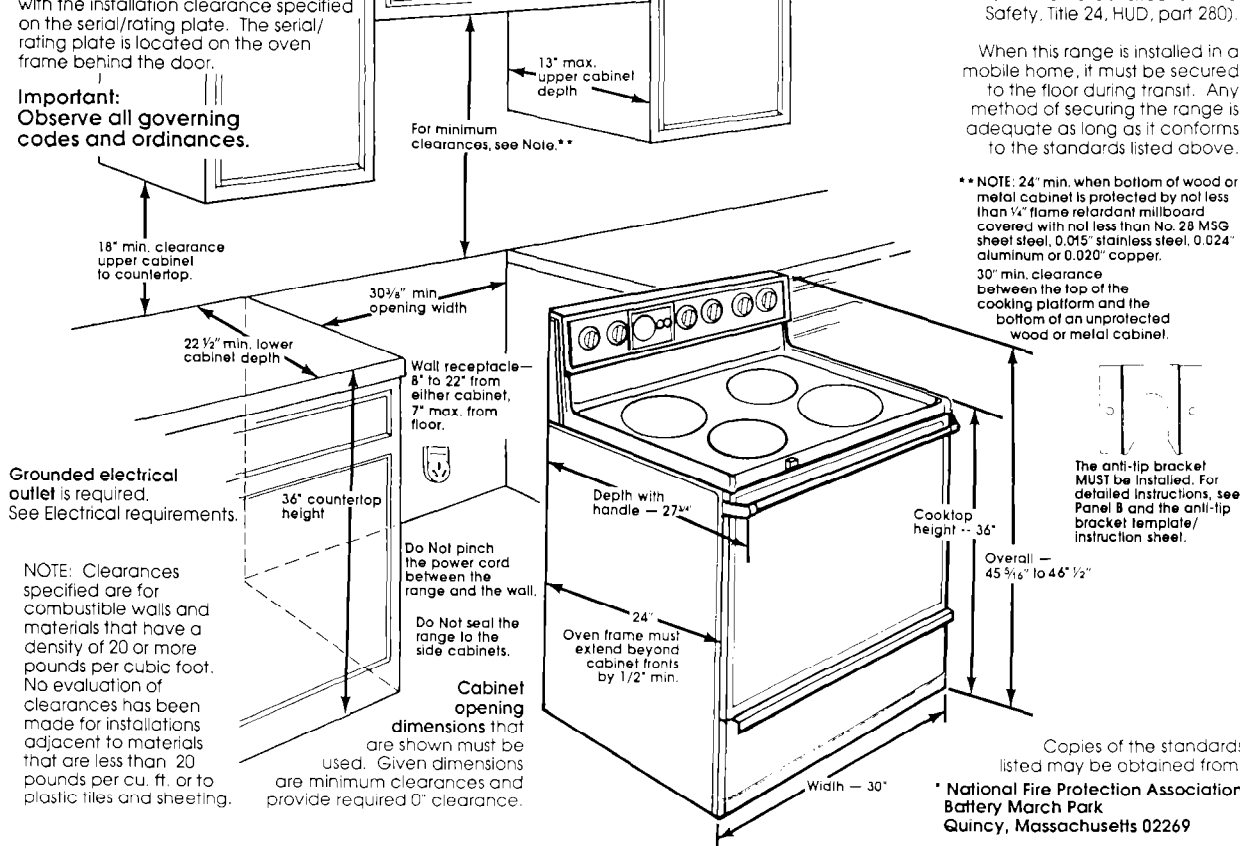

## Mobile home installation

The installation of this range must conform to the Manufactured Home Construction and Safety Standards, Title 24 CFR, part 3280 (formerly the Federal Standard for Mobile Home Construction and Safety, Title 24, HUD, part 280).

When this range is installed in a mobile home, it must be secured to the floor during transit. Any method of securing the range is adequate as long as it conforms to the standards listed above.

**\*\* NOTE:** 24\" min. when bottom of wood or metal cabinet is protected by not less than 1/4\" flame retardant millboard covered with not less than No. 28 MSG sheet steel, 0.015\" stainless steel, 0.024\" aluminum or 0.020\" copper.

30\" min. clearance between the top of the cooking platform and the bottom of an unprotected wood or metal cabinet.

The anti-tip bracket MUST be installed. For detailed instructions, see Panel B and the anti-tip bracket template/instruction sheet.

Copies of the standards listed may be obtained from:

**\* National Fire Protection Association  
Battery March Park  
Quincy, Massachusetts 02269**

## ⚠ WARNING

### Personal Injury Hazard

Cabinet storage above the cooking surface should be avoided. If cabinets are already installed, reduce the hazard of reaching over a heated cooking surface by installing a range hood.

The range hood should extend a minimum of 5 inches out from the bottom front of the cabinets.

Reaching over a heated cooking surface could result in a serious burn.

## ⚠ WARNING

### Electrical Shock Hazard

It is the customer's responsibility:

- To contact a qualified electrical installer.
- To assure that the electrical installation is adequate and in conformance with National Electrical Code, ANSI/NFPA 70 - latest edition\*, and all local codes and ordinances.

Failure to do so could result in fire, electrical shock or other personal injury.

## Tools needed for installation:

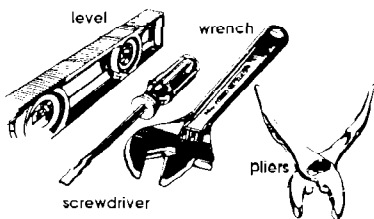

## Electrical requirements

### IMPORTANT:

Save Installation Instructions for electrical inspector's use.

A power supply cord is not supplied with this appliance but is available through your local electrical supply house.

## ⚠ WARNING

### Electrical Shock Hazard

- Electrical ground is required on this appliance.
- Improper connection of the equipment-grounding conductor can result in electrical shock.
- Check with a qualified electrician if you are in doubt as to whether the appliance is properly grounded.
- Only a power supply cord kit rated at 240 volts, 40 amperes and investigated for use with ranges should be used.
- Do Not use an extension cord with this appliance. Such use may result in a fire, electrical shock or other personal injury.
- Do Not have a fuse in the neutral or grounding circuit. A fuse in the neutral or grounding circuit could result in electrical shock.
- Do Not plug the "pigtail" power cord into a live wall receptacle before the cord is permanently connected to the terminal block. To do so may result in personal injury from electrical shock. Failure to follow these instructions could result in an electrical shock.

**A.** A three-wire or four-wire, single phase, 120/240-volt, 60-Hz, AC only, electrical supply (or three-wire or four-wire 120/208-volt if specified on the serial plate) is required on a separate, 40-ampere circuit, fused in both sides of the line. (A time-delay fuse or circuit breaker is recommended.)

It is the personal responsibility and obligation of the customer to contact a qualified electrician to assure that the electrical installation is adequate and in conformance with the National Electrical Code, ANSI/NFPA 70-latest edition,\* and local codes and ordinances.

**B.** THE RANGE MUST BE CONNECTED WITH COPPER WIRE ONLY.

**C.** Local codes may permit the use of a U.L.-LISTED, 40 ampere range power supply cord (pigtail). This cord contains three, No.-10 copper wires and matches a three-wire receptacle of NEMA Type 10-50R, shown in Figure 1. Connectors on the appliance end must be ring terminals. A U.L.-listed strain relief must be provided at the point the power supply cord enters the appliance.

**D.** The appliance may be connected directly to the fused disconnect or circuit breaker box through flexible, armored or non-metallic sheathed, copper cable. Allow two or three feet of slack in the line so that it can be moved if servicing is ever necessary. A U.L.-listed strain relief must be provided at each end of the power supply cord (at the appliance and at the junction box.) Wire sizes (COPPER WIRE ONLY) and connections must conform with the rating of the appliance (40 amperes).

**E.** IF CONNECTING TO A 4-WIRE ELECTRICAL SYSTEM: This appliance is manufactured with ground connected to cabinet. The **ground must be revised** so the green grounding wire of the 4-wire power cord is connected to the cabinet. See 4-wire electrical connection section, Panel C.

When a 4-wire receptacle of NEMA type 14-50R is used (See Figure 2), a matching U.L.-listed, 4-wire, 120/240-volt, 40-ampere, range power supply cord (pigtail) must be used. This cord contains four copper conductors with ring terminals on the appliance end, terminating in a NEMA Type 14-50R plug on the supply end. The fourth (grounding) conductor must be identified by a green or green/yellow cover and the neutral conductor by a white cover. Cord should be Type SRD or SRDT with a U.L.-listed strain relief and be at least four feet long.

2. The **MINIMUM** conductor sizes for the copper 4-wire power cord are:

- 40 ampere circuit
- 2, No. 8 conductors
- 1, No. 10 white neutral
- 1, No. 8 green grounding

The wiring diagram is also located on the back of the range.

**F.** The wiring diagram is also located on the back of the range.

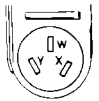

3-wire wall receptacle (10-50R)  
Figure 1



4-wire receptacle (14-50R)  
Figure 2

## Now start...

With range in kitchen.

**1.** Remove racks and other parts from inside oven.

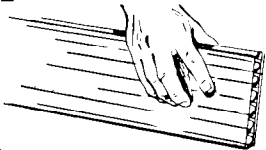

**2.** Take 4 cardboard corners from the carton. Stack one cardboard corner on top of another. Repeat with other two corners. Place corners lengthwise on the floor in back of range to support range off of skid.

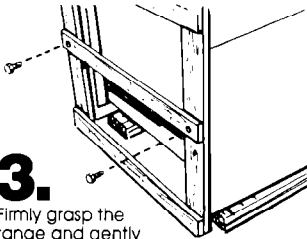

**3.** Firmly grasp the range and gently lay it on its back on the cardboard corners.

**4.** Remove two 3/8" shipping bolts from the skid. Discard skid and bolts.

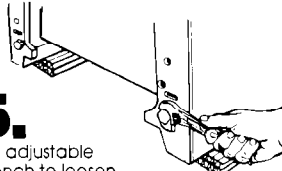

**5.** Use adjustable wrench to loosen leveling legs four complete turns.

**6.** Stand the range back up.

Panel B

**7.** Remove the shipping materials including clips that hold elements in place, tape and protective film from range.

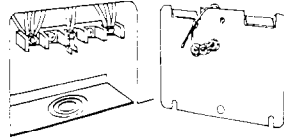

**8.** Remove terminal block cover located on back of range.

### 3-wire electrical connection

See Panel C for 4-wire electrical connection.

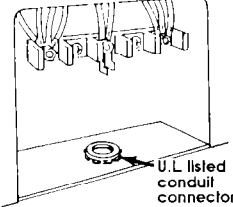
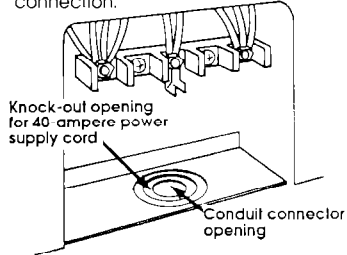

**9.** If appliance is to be connected directly to fused disconnect or circuit breaker box: Assemble a U.L.-listed conduit connector in the conduit connector opening provided. Insert the power supply cable through the conduit connector, allowing enough slack to easily attach the wiring to the terminal block.

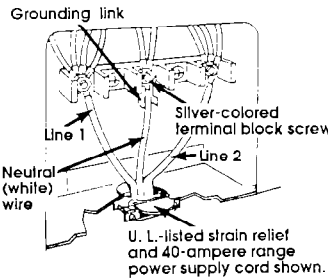

If a U.L.-listed, 40-ampere range power supply (pigtail) is used:

Remove the knockout for the 40-ampere power supply cord.

Assemble a U.L.-listed strain relief in the hole. Insert the power supply cord through the strain relief, allowing enough slack to easily attach the wiring to the terminal block.

Do not loosen the factory installed nuts already installed on the terminal block.

Use only ring-type terminals to connect the power supply. To secure the power supply cord, use the 3/8" brass nuts taped to cabinet below the terminal block. Be sure the wiring nuts are installed tight.

**Use this wiring method ONLY if local codes permit connecting cabinet-grounding conductor to neutral wire of power cord.**

This appliance is manufactured with neutral terminal connected to the frame. If local codes and ordinances Do Not permit grounding through the neutral, a four-wire power supply cord, rated 240 volts, 40 amperes and investigated for use with ranges must be used. See 4-wire electrical connection, Panel C.

**10.** Connect the neutral (white) wire to the center, silver-colored terminal screw on terminal block. Connect the other two wires to the outer terminal screws on the terminal block. Use ring-type terminals only. Connect with the brass nuts attached to the range. Do Not loosen factory-installed nuts already on the terminal. Check that nuts are tight to insure proper electrical connection.

**11.** Tighten the strain relief clamping screws or the locking ring and clamping screws of the conduit connector. Replace terminal block cover.

## 12.

### WARNING

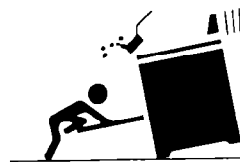

To reduce the risk of tipping of the appliance, the appliance must be secured by a properly installed anti-tip bracket supplied with the range.

Use the anti-tip bracket template/instruction sheet to install the anti-tip bracket.

**13.** Plug power supply cord into the wall receptacle.

### CAUTION

#### Floor Damage

Keep shipping base under range. Failure to do so could cause damage to floor covering.

## 14.

Move the range into final operating position. Remove cardboard or hardboard from under range. Remove storage drawer or lower panel and check that rear leg is engaged in anti-tip bracket.

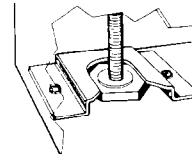

## 15.

If installing the range in a mobile home, you **MUST** secure the range to the floor. Any method of securing the range is adequate as long as it conforms to the standards listed in the Mobile home installation instructions, Panel A.

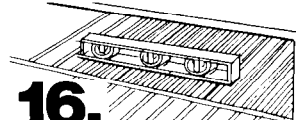

## 16.

Place rack in oven. Place level on rack, first side to side; the front to back. If the range is not level, pull the range forward until rear leveling leg is removed from the bracket. Adjust the legs up or down until range is level.

Push range back into position. Check that the rear leveling leg is engaged in the bracket. Replace the storage drawer or lower panel.

Note: Oven must be level for satisfactory baking conditions.

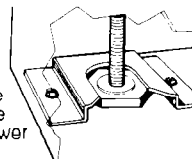

**17.**

Push in and turn each surface unit control knob to "HI" position. Check the operation of the cooktop elements and indicator lights.

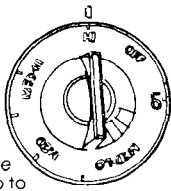

**18.**

Check the operation of the oven element. Set the oven selector control knob to "BAKE". Set the oven temperature control to 350°F. The bottom element should glow red and the indicator light should be on. The upper element should become hot but not glow red. The oven indicator light goes off when the oven is preheated.

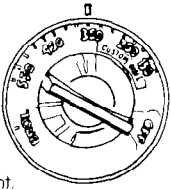

**19.**

Check the operation of the broil element. Set the oven selector and oven temperature control knobs to "BROIL". The top element should glow red and the indicator light should be on.

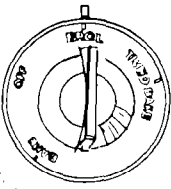

**4-wire electrical connection**

Use this wiring method for mobile homes and whenever 4-wire installation is required.

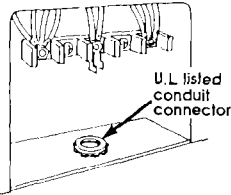

**A.** If appliance is to be connected directly to fused disconnect or circuit breaker box: Assemble a U.L.-listed conduit connector in the conduit connector opening provided. Insert the power supply cable through the conduit connector, allowing enough slack to easily attach the wiring to the terminal block.

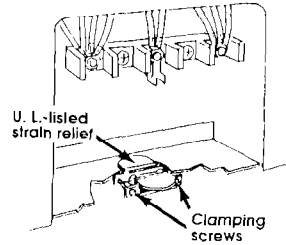

If a U.L.-listed, 40-ampere range power supply (pigtail) is used: Remove the knockout for the 40-ampere power supply cord. Assemble a U.L.-listed strain relief in the hole. Insert the power supply cord through the strain relief, allowing enough slack to easily attach the wiring to the terminal block. Do not loosen the factory installed nuts already installed on the terminal block.

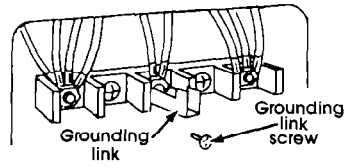

**B.** Remove the grounding-link screw from the range frame. Save the grounding screw. Bend up the grounding link so that it does not contact the range.

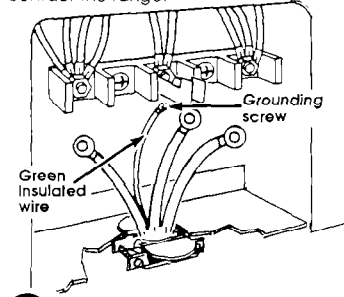

**C.** Connect the green grounding wire to the range using the grounding screw removed in Step B. The green grounding wire must be attached first and must not contact any other terminal.

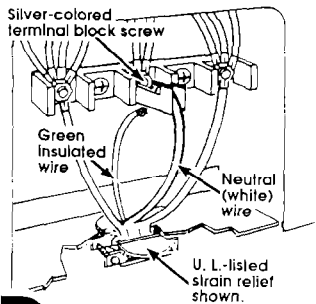

**D.** Connect the neutral (white) wire to the center, silver-colored terminal screw on the terminal block. Connect the other two wires to the outer terminals on the terminal block. Use ring-type terminals only. Connect and securely tighten the brass nuts that are provided on a plastic strip attached to the range. Do Not loosen the factory-installed nuts already on the terminal. Be sure that the nuts are installed tight.

**E.** Tighten the strain relief clamping screws or the locking ring and clamping screws of the conduit connector. Replace the terminal block cover.

**F.** Continue installation at Step 12, Panel B.

To get the most efficient use from your new range, read your Use and Care Guide. Keep Installation Instructions and Guide close to the range for easy reference.

8. 9. 10. 11.

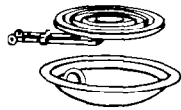
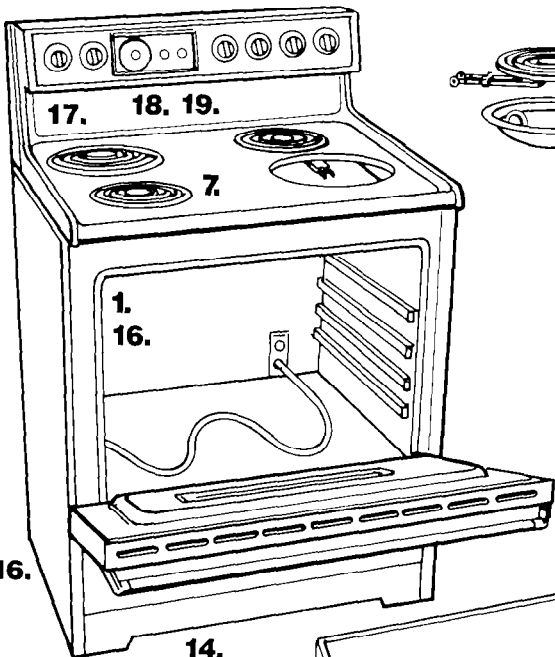

Numbers correspond to steps.

16.

5.

15.

14.

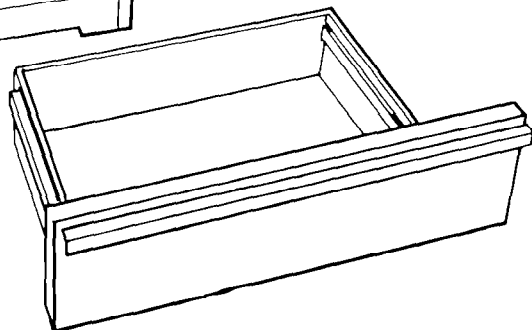

## If range does not operate...

Check that the circuit breaker is not tripped or the fuse blown. Check that power supply cord is plugged into wall receptacle.



Part No. 3150250  
©1990 Whirlpool Corporation

Prepared by Whirlpool Corporation, Benton Harbor, Michigan 49022

Printed in U.S.A.

## Free Manuals Download Website

<http://myh66.com>

<http://usermanuals.us>

<http://www.somanuals.com>

<http://www.4manuals.cc>

<http://www.manual-lib.com>

<http://www.404manual.com>

<http://www.luxmanual.com>

<http://aubethermostatmanual.com>

Golf course search by state

<http://golfingnear.com>

Email search by domain

<http://emailbydomain.com>

Auto manuals search

<http://auto.somanuals.com>

TV manuals search

<http://tv.somanuals.com>