



### ONE (1) YEAR LIMITED WARRANTY

**EURO-PRO Operating LLC** warrants this product to be free from defects in material and workmanship for a period of one (1) year from the date of the original purchase, when utilized for normal household use, subject to the following conditions, exclusions and exceptions.

If your appliance fails to operate properly while in use under normal household conditions within the warranty period, return the complete appliance and accessories, freight prepaid to:

US: **EURO-PRO Operating LLC**, 94 Main Mill Street, Door 16, Plattsburgh, N.Y. 12901

CANADA: **EURO-PRO Operating LLC**, 4400 Bois Franc, St. Laurent, QC, H4S 1A7

If the appliance is found by **EURO-PRO Operating LLC** to be defective in material or workmanship, **EURO-PRO Operating LLC** will repair or replace it free of charge. Proof of purchase date and \$ 14.95 to cover the cost of return shipping and handling must be included. \*

Non-durable parts including, without limitation, filters, brushes and electrical parts which normally require replacement are specifically excluded from warranty.

The liability of **EURO-PRO Operating LLC** is limited solely to the cost of the repair or replacement of the unit at our option. This warranty does not cover normal wear of parts and does not apply to any unit that has been tampered with or used for commercial purposes. This limited warranty does not cover damage caused by misuse, abuse, negligent handling or damage due to faulty packaging or mishandling in transit. This warranty does not cover damage or defects caused by or resulting from damages from shipping or repairs, service or alterations to the product or any of its parts, which have been performed by a repair person not authorized by **EURO-PRO Operating LLC**.

This warranty is extended to the original purchaser of the unit and excludes all other legal and/or conventional warranties. The responsibility of **EURO-PRO Operating LLC** if any, is limited to the specific obligations expressly assumed by it under the terms of the limited warranty. **In no event is EURO-PRO Operating LLC** liable for incidental or consequential damages of any nature whatsoever. Some states do not permit the exclusion or limitation of incidental or consequential damages, so the above may not apply to you.

This warranty gives you specific legal rights, and you may also have other rights which vary from state to state or province to province.

**\*Important: Carefully pack item to avoid damage in shipping. Be sure to include proof of purchase date and to attach tag to item before packing with your name, complete address and phone number with a note giving purchase information, model number and what you believe is the problem with item. We recommend you insure the package (as damage in shipping is not covered by your warranty). Mark the outside of your package "ATTENTION CUSTOMER SERVICE". We are constantly striving to improve our products, therefore the specifications contained herein are subject to change without notice.**



### OWNERSHIP REGISTRATION CARD FOR CANADIAN CONSUMERS ONLY

Please fill out and mail the product registration card within ten (10) days of purchase. The registration will enable us to contact you in the unlikely event of a product safety notification. By returning this card you acknowledge to have read and understood the instructions for use, and warnings set forth in the accompanying instructions.

RETURN TO: **EURO-PRO Operating LLC**, 4400 Bois Franc, St. Laurent, Quebec, H4S 1A7

**Model EP619**

---

**Appliance model**

---

**Date purchased** **Name of store**

---

**Owner's name**

---

**Address** **City** **Prov.** **Postal code**



## LIMITED EDITION LIGHTWEIGHT BAGLESS Upright Vac

### OWNER'S MANUAL

**Model EP619**  
120V., 60Hz., 12 Amps



# IMPORTANT SAFETY INSTRUCTIONS

When using your **Lightweight Bagless Upright Vac** basic safety precautions should always be observed, including the following:

1. Read all instructions before using your vacuum.
2. Use the system only for its intended use.
3. To protect against a risk of electric shock, do not immerse any part of the system in water or other liquids.
4. **Never** yank cord to disconnect from outlet; instead, grasp plug and pull to disconnect.
5. **Do not** allow cord to touch hot surfaces.
6. **Do not** run appliance over cord.
7. **Do not** operate the system with a damaged cord or plug, or if the appliance or any other part of the system has been dropped or damaged. To avoid the risk of electric shock, do not disassemble or attempt to repair the vacuum. Return the vacuum to **EURO-PRO Operating LLC** (see warranty) for examination and repair. Incorrect re-assembly or repair can cause a risk of electrical shock or injury to persons when the vacuum is used.
8. Close supervision is necessary for any appliance being used by or near children. Do not leave the system unattended while connected.
9. Keep hair, loose clothing, fingers and all parts of body away from opening and moving parts.
10. **Do not** use to pick up flammable or combustible liquids such as gasoline or use in areas where they may be present.
11. **Do not** pick up anything that is burning or smoking such as cigarettes, matches or hot ashes.
12. Use extra care when cleaning on stairs.
13. **Do not** use the vacuum without the all the filters in place.
14. This appliance is intended only for household use. Follow all user instructions in this manual.

## To reduce the risk of fire, electric shock, or injury:

- **Do not** leave the vacuum plugged in when unattended. Unplug the electrical cord when not in use and before servicing.
- **Do not** allow the vacuum to be used as a toy. Close attention is necessary when used by or near children, pets or plants.
- Use only as described in this manual. Use only manufacturer's recommended accessories.
- **Do not** pull cord, use cord as a handle, close a door on cord, or pull cord around sharp edges or corners. Keep cord away from heated surfaces.
- Use **only** extension cords UL-rated or cUL at 15 amperes. Extension cords rated for less amperage may overheat. Care should be taken to arrange the cord so that the cord cannot be pulled or tripped over.
- Turn off all controls as applicable before unplugging from electrical outlet.
- **Do not** handle plug or vacuum with wet hands or operate without shoes.
- **Do not** put any objects into openings. Do not use with any opening blocked. Keep free of dust, lint, hair and anything else that may reduce air flow.
- Store your appliance indoors in a cool, dry area.
- Keep your work area well lit.
- Keep end of hose, wands and other openings away from your face and body.
- Use only on dry surfaces.
- Using improper voltage may result in damage to the motor and possible injury to the user. Correct voltage is listed on rating label.

# SAVE THESE INSTRUCTIONS

## For Household Use Only



**WARNING:** To reduce the risk of electric shock, this appliance has a polarized plug (one blade is wider than the other). This plug will fit in a polarized outlet only one way. If the plug does not fit fully in the outlet, reverse the plug. If it still does not fit, contact a qualified electrician to install the proper outlet. Do not modify the plug in any way.

# TROUBLE SHOOTING GUIDE

PROBLEM	POSSIBLE REASON	POSSIBLE SOLUTION
VACUUM WILL NOT OPERATE	<ol style="list-style-type: none"> <li>1. Power cord not firmly plugged into outlet.</li> <li>2. No power in wall outlet.</li> <li>3. Needs servicing.</li> <li>4. Thermostat has tripped.</li> </ol>	<ol style="list-style-type: none"> <li>1. Plug unit in firmly.</li> <li>2. Check fuse or breaker. Replace fuse/reset breaker.</li> <li>3. Call 1-800-798-7398.</li> <li>4. Turn the unit off and unplug from outlet. Allow unit to cool down, then restart.</li> </ol>
VACUUM WILL NOT PICK-UP OR SUCTION POWER IS WEAK	<ol style="list-style-type: none"> <li>1. Dust cup is full.</li> <li>2. Unit clogged.</li> <li>3. HEPA Filter needs cleaning or replacing.</li> <li>4. Debris screen needs cleaning.</li> <li>5. Exhaust filter or filter ring need cleaning.</li> </ol>	<ol style="list-style-type: none"> <li>1. Empty and clean dust cup.</li> <li>2. Turn unit off and unplug from wall outlet. Remove Dust Cup Filter and check for object(s) in air duct and remove.</li> <li>3. Clean or replace HEPA Filter.</li> <li>4. Clean debris screen.</li> <li>5. Clean exhaust filter or filter ring.</li> </ol>
DUST ESCAPING FROM VACUUM	<ol style="list-style-type: none"> <li>1. Dust cup is full.</li> <li>2. Dust Cup is not installed correctly.</li> </ol>	<ol style="list-style-type: none"> <li>1. Empty and clean dust cup.</li> <li>2. Review Dust Cup instructions.</li> </ol>
VACUUM, HOSE OR BRUSHES WILL NOT PICK-UP	<ol style="list-style-type: none"> <li>1. Hose clogged.</li> <li>2. Dust cup is full.</li> </ol>	<ol style="list-style-type: none"> <li>1. Remove hose and/or brushes. Remove obstruction from hose and /or brush.</li> <li>2. Empty and clean dust cup.</li> </ol>

# ORDERING REPLACEMENT HEPA DUST CUP FILTERS

## TO ORDER REPLACEMENT HEPA FILTERS

### Item XSH621 for Model EP619

Call: 1 (800) 798-7398

Monday to Friday 8:30 A.M. - 5:00 P.M. Eastern Standard Time  
Or visit our website: [www.sharkvac.com](http://www.sharkvac.com)

## FOR TECHNICAL SUPPORT

### for Model EP619

Call: 1 (800) 798-7398

Monday to Friday 8:30 A.M. - 5:00 P.M. Eastern Standard Time

### Please Note:

The HEPA Filter is washable. It should, however, be replaced every (3) three to six (6) months to ensure peak performance of your vacuum. The exhaust filter and filter ring are rinseable. They should however be replaced every three (3) months to ensure peak performance of your vacuum.

### Important:

Make sure that **ALL** filters have been completely air dried for 24 hours before re-installing back in the vacuum.

## OPERATING INSTRUCTIONS

### Changing the Belt

**! WARNING:** Always disconnect from power source when servicing or cleaning the unit. Failure to do so could result in electrical shock or personal injury from cleaner suddenly starting.

Occasionally the motorized brush drive belt will require changing, the frequency will depend upon the amount of use your vacuum sees.

- Turn unit "Off" and unplug from wall outlet.
- Remove the motorized floor brush from the main unit.
- Use a Phillips #1 screwdriver and remove the two (2) front screws from the bottom of the motorized floor brush. (Fig. 18)

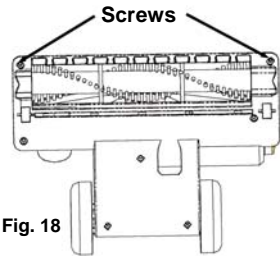

Fig. 18

- Remove the brush carefully by first lifting the right side of the brush and then the left side of the brush. Be careful not to lose the end caps and washers (x2). (Fig. 20)
- If the belt has broken, remove any loose pieces of broken belt before replacing with new belt.
- To stall a new belt, slip one end of the belt over the gears on the motor shaft and then slip the other end over the pulley end of the brush.
- After checking that the end caps and washers are on correctly, re-install the brush assembly.
- Turn the brush assembly by hand to make sure that the belt is not twisted and all rotating parts turn freely.
- Replace the brush cover and screws. (Fig. 21)

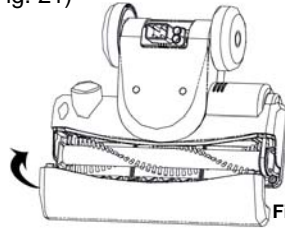

Fig. 21

### Motor Thermostat

**IMPORTANT:** This unit is equipped with a motor protective thermostat. If for some reason the vacuum cleaner should overheat, the thermostat will automatically turn the unit off. Should this occur:

- Push the On/Off button once.
- Disconnect the plug from the power source.
- Check the source of overheating problem. (i.e. clogged hose or filter)
- If clogged hose or filter is found, unclog the hose and replace the filters.
- Wait at least 45 minutes before attempting to reuse the vacuum.
- After unit has cooled down for 45 minutes, plug in the cleaner and push the On/Off button. The vacuum should start again.
- If the vacuum still does not start, contact customer service at 1 (800) 798-7398.

- Remove the brush cover. (Fig. 19)

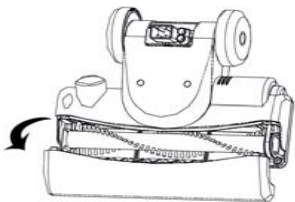

Fig. 19

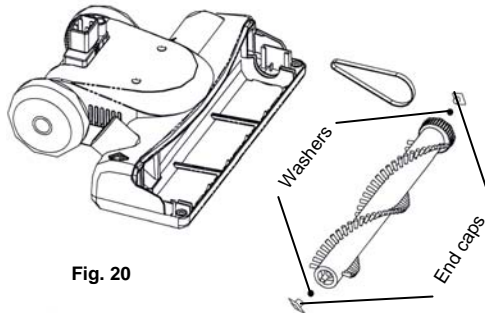
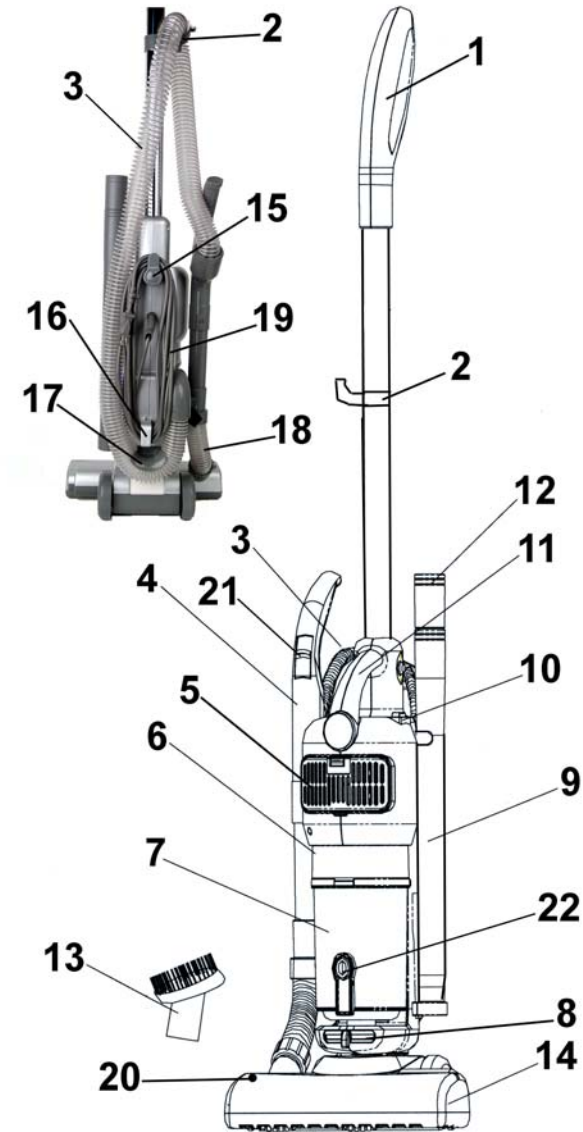

Fig. 20

## GETTING TO KNOW YOUR LIGHTWEIGHT BAGLESS UPRIGHT VAC

1. Hand Grip
2. Hose/Power Cord Holder
3. Flexible Hose
4. Removable Hose Handle
5. Exhaust Filter Cover
6. Main Unit
7. Dust Cup Container
8. Dust Cup Release Lever
9. Extension Tube
10. On/Off Switch
11. Lifting Handle
12. Crevice Tool
13. Dusting Brush
14. Motorized Floor Brush
15. Quick Release Cord Holder
16. Lower Cord Holder
17. Lower Hose Holder
18. Inlet Hose
19. Power Cord
20. Brush Roll Warning Light
21. Manual Variable Suction Control
22. Trap Door Release Button
23. Intelli-Sense™ Filter Monitor
24. Hose Clip



### Technical Specifications

Voltage: 120V., 60Hz.  
Power: 12 Amps

\* Illustrations may differ from actual product.

## PRECAUTIONARY MEASURES

**IMPORTANT:** If the suction opening in the unit or the hose is **BLOCKED**, switch off the vacuum cleaner and remove the blocking substance before you start the unit again.

1. **Do not** operate the vacuum cleaner too close to heaters, radiators or cigarette butts.

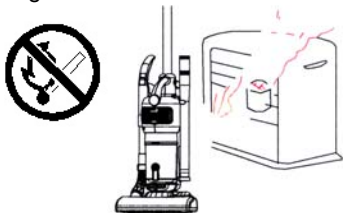

4. When pulling out the power plug from the wall outlet, pull the plug not the power cord.



5. **Do not** pick up anything that is burning or smoking such as cigarettes, matches or hot ashes.

6. **Do not** use without **ALL** filters in place.

2. Before inserting the power plug into the wall outlet, make sure that your hands are dry.

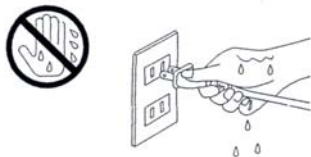

3. Before you start vacuuming, make sure to remove large or sharp objects that might damage the dust cup debris screen.

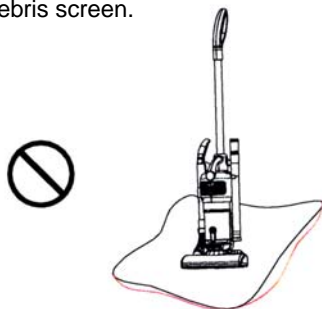

## OPERATING INSTRUCTIONS

**Warning:** Always empty the dust cup container and clean the HEPA filter and Debris Screen before each use and during prolonged usage.

Never over fill the dust cup container - remove dirt and clean the HEPA filter, filter ring and debris screen when dirt in dust cup is at or below the "MAX" level or during prolonged usage because you could risk damaging the motor.

**If you wash the Hepa filter and filter ring, make sure that they have completely air dried for 24 hours before inserting back into the vacuum.**

**Please Note:** The HEPA Filter is washable. It should, however, be replaced every three (3) to six (6) months to ensure peak performance of your vacuum.

The exhaust filter and filter ring are also rinseable but they should be air dried for 24 hours before replacing into the vacuum. They should however be replaced every three (3) months to ensure peak performance of your vacuum.

**Important:** Make sure that **ALL** filters are completely dry before re-installing back in the vacuum.

### Cleaning the Filter Ring

1. Around the HEPA filter there is a filter ring. This is washable in lukewarm water. (Fig. 16) To remove the filter ring, slide it off the HEPA filter.
2. We recommend washing the filter ring when you are washing your HEPA filter. Always allow the filter ring to air dry for 24 hours before replacing onto the HEPA filter. Never run the vacuum without all the filters in place.

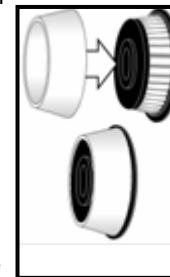

Fig. 16

**Note:** This is a washable filter, but we recommend replacing it every three (3) months.

### Changing & Cleaning the Exhaust Filter

The exhaust filter is a rinseable filter but should be replaced every three (3) months.

- To remove the exhaust filter cover, depress the filter cover lock and pull the filter cover out. Remove the filter. (Fig. 17)
- Rinse the exhaust filter in lukewarm water and air dry the filter completely for 24 hours. Do not use a washing machine to rinse the filter. Do not use a hair dryer to dry it. Air dry only. Never operate the vacuum without the exhaust filter in place.
- When the filter is dry, replace into the exhaust filter cover and replace on the vacuum.
- A severely soiled or clogged filter should be thoroughly rinsed with fresh tepid water. A mild detergent can be used if required.

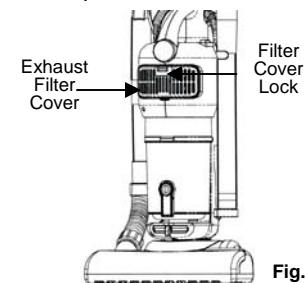

Fig. 17



## OPERATING INSTRUCTIONS

### Cleaning the HEPA Filter and the Debris Screen

**! WARNING:** After each Use - Always remove the Filter Assembly, then vigorously "TapClean" HEPA Filter and clean Debris Screen until no more dust can be removed.

**IMPORTANT, Please Note:** The "TapClean" HEPA Filter will stop most of the tiniest dust particles and airborne allergens from re-entering the air you breathe. Because of this incredible filtration performance, the HEPA Filter will quickly accumulate, inside the white filter folds, many fine dust particles that are difficult to see but which will eventually block or reduce your suction power - if not cleaned properly.

1. To remove the filter assembly from the dust cup, hold the dust cup from the handle in one hand and with the other hand, turn counter clockwise and pull out the filter cover. (Fig. 14)

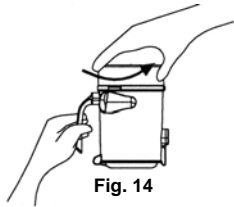

Fig. 14

2. To separate the filter assembly, hold the bottom of the debris screen and pull the filter cover out. (Fig. 15)

#### Filter Assembly

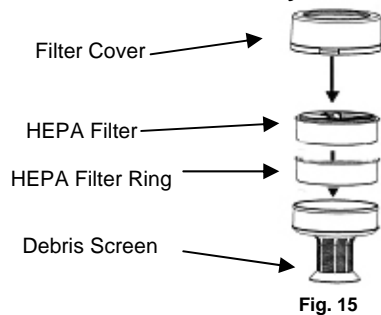

Fig. 15

- Remove the HEPA filter from the debris screen. Remove the filter ring that is around the HEPA filter. Then vigorously "TapClean" the HEPA Filter on a hard surface until no more dust is observed falling out.
- To clean the debris screen, we recommend that you rinse it under lukewarm running water to remove the dirt that accumulates on it, but always allow 24 hours to air dry before inserting back into the vacuum.
- To re-assemble the filter assembly, insert the filter ring over the HEPA filter and then insert the HEPA filter assembly into the debris screen. Insert the debris screen into the filter cover. Replace the filter assembly into the dust cup.



**PLEASE NOTE:** The white pleated filter material in the HEPA Filter will discolor over time -This is NORMAL and will NOT affect the performance of the filter. If the HEPA Filter is properly "TapCleaned" after each use and suction does not return to 100%, then we suggest that the HEPA filter be "TapCleaned" vigorously until no more dust can be removed,

then rinsed under the faucet and allowed to air dry for 24 hours before refitting into the vacuum. (Fig. A) **This should be done once a month or when suction appears to be reduced .**

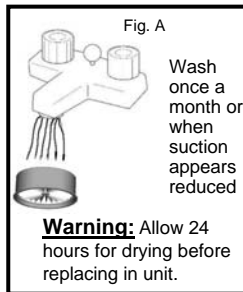

Fig. A

Wash once a month or when suction appears reduced

**Warning:** Allow 24 hours for drying before replacing in unit.

## OPERATING INSTRUCTIONS

**WARNING:** Always remove the power plug from the wall outlet before assembling or removing accessories.

### Inserting the Handle Into the Main Unit

- Insert the handle into the hole on the top of the unit. Make sure that the slot in the handle fits correctly into the opening. (Fig. 1)
- Insert the sleeve nut into the unit first. Then holding the sleeve nut with your thumb, insert the bolt. Using a flat screw driver, secure the bolt to the sleeve nut. (Fig. 1)
- To remove the handle, you have to remove the bolt and the sleeve nut.

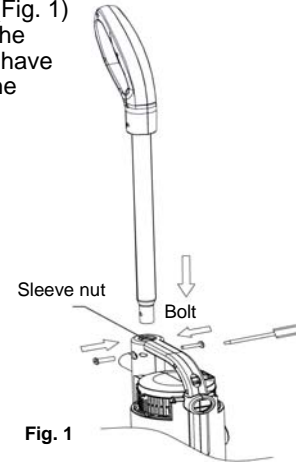

Fig. 1

### ATTACHING THE FLOOR BRUSH TO THE MAIN UNIT

- Insert the floor brush into its location at the bottom of the main unit, in the direction of the arrow. (Fig. 2)
- Make sure that the floor brush is firmly inserted into the floor brush socket.
- Insert the inlet hose into the floor brush hose connector that is on the floor brush. (Fig. 3)
- To remove the floor brush from the main unit, press on the floor brush release button and pull the floor brush out.

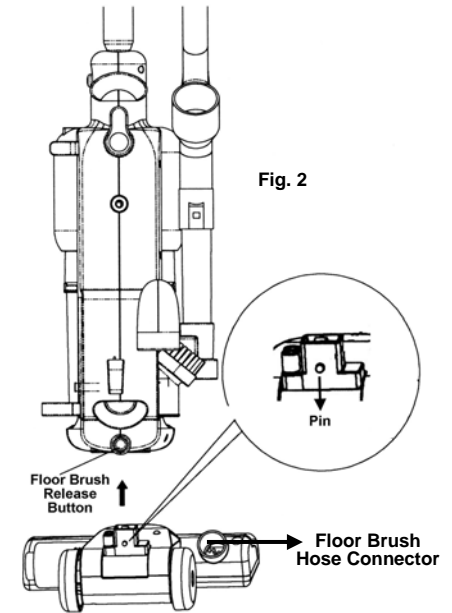

Fig. 2

### ATTACHING THE HOSE TO THE MAIN UNIT

Hold the end of the removable hose handle and insert it into the hose connector. (Fig. 3)

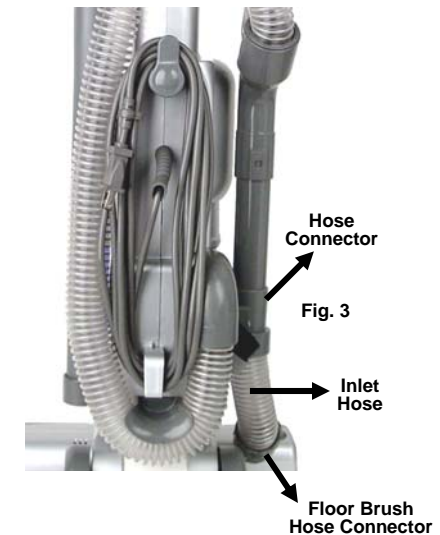
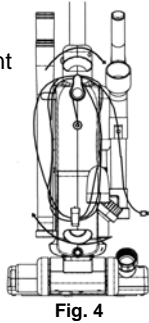

Fig. 3

## OPERATING INSTRUCTIONS

### WINDING & UNWINDING THE POWER CORD

This vacuum cleaner is equipped with a convenient cord storage feature. The power cord winds around the two cord holders at the back of the unit. The top one has a quick cord release feature. Turn the cord hook to the left or the right to remove the power cord. (Fig. 4)



When using the vacuum, attach the power cord to the cord holder so that the power cord is out of the way when you are vacuuming. (Fig. 5)

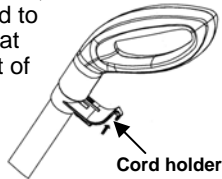

Fig. 5

### ON/OFF SWITCH

The On/Off switch has three different positions. (Fig.6)

- Push on the "I" side to turn the vacuum ON. Set the vacuum here when using the removable hose handle with the accessories or when vacuuming bare floors.
- Push on the "II" side to turn the motorized floor brush on.
- Push on the "O" side to turn the vacuum to the OFF position.



Fig. 6

Motorized Floor Brush ON

### USING THE UNIT With the Motorized Floor Brush

- Unwind the power cord and plug into the 120V outlet.
- Press the On/Off switch to the "II" position so that both the vacuum and the motorized floor brush is turned "ON"

**NOTE:** When vacuuming deep pile carpets or hard wood floors, lower the angle of the handle (see illustration at right) for easier maneuverability. (Fig. 7)

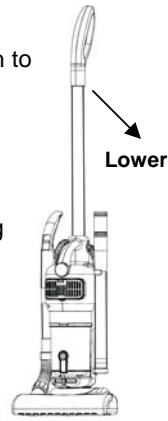

Fig. 7

### USING THE UNIT WITH THE ACCESSORIES

- Remove the removable hose handle from the hose connector.
- Attach the extension tube, crevice tool or the dusting brush to the end of the hose. (Fig. 8)

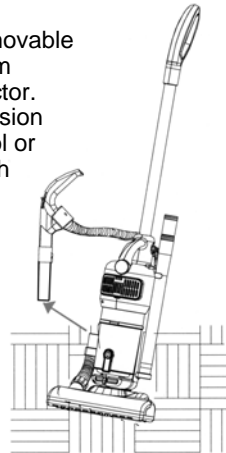

Fig. 8

### MANUAL VARIABLE SUCTION CONTROL

Your vacuum cleaner includes a variable suction control valve on the hose extension. The suction power can be adjusted by moving the slide to the desired position. For example. Less suction is required on upholstery and draperies compared to thick shag carpets, which require maximum suction.

## OPERATING INSTRUCTIONS

### Extension Tube

For hard to reach places. Use with crevice tool or with dusting brush.

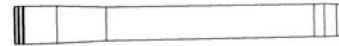

### Crevice Tool

For radiators, crevices, corners, baseboards and between cushions.



### Dusting Brush

The dusting brush is used for the furniture, venetian blinds, books, lamp shades and shelves.



### Intelli-Sense™ Filter Monitor

When the Intelli-Sense™ Filter Monitor lights up, it means that the dust cup is full or the HEPA filter, filter ring or Debris Screen needs cleaning. You must empty the dust from the dust cup and clean the HEPA filter and Debris Screen right away.

### Brush Roll Warning Light

If while using the motorized floor brush the brush becomes jammed or picks up an object which causes the brush roll to cease revolving, the red indicator light will illuminate. In this case:

1. Turn unit "Off" and unplug from wall outlet.
2. Remove the motorized floor brush from the main unit.
3. Use a Phillips #1 screwdriver and remove the two (2) front screws from the bottom of the motorized floor brush. (Fig. 9)

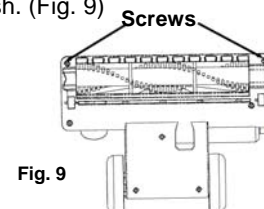

Fig. 9

4. Remove the brush cover. (Fig. 10)

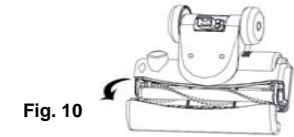

Fig. 10

5. To gently remove the object, hair or fibers pull slowly to release. Removing with scissors may be necessary, however, avoid damaging or cutting the bristles.

### Emptying the Dust Cup Container

**Important:** Do NOT use the vacuum without ALL the filters in place.

**Warning:** Always unplug the unit from electrical outlet before opening the Dust Cup (container).

1. To remove the dust cup container, turn the dust cup release lever to the right. (Fig. 11)

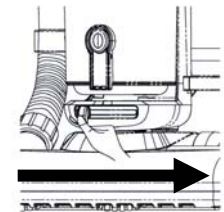

Fig. 11

2. Remove the dust cup from the vacuum. (Fig. 12)
3. To empty the dust cup container, hold the dust cup from the handle over a garbage container and press on the trap door release button that is on the front side of the dust cup container to release the dust cup bottom (Fig. 13)

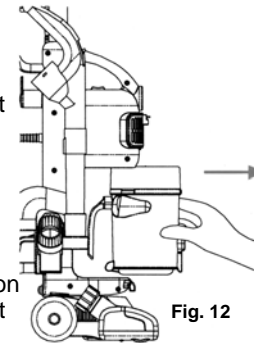

Fig. 12

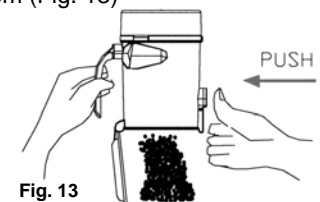

Fig. 13

## Free Manuals Download Website

<http://myh66.com>

<http://usermanuals.us>

<http://www.somanuals.com>

<http://www.4manuals.cc>

<http://www.manual-lib.com>

<http://www.404manual.com>

<http://www.luxmanual.com>

<http://aubethermostatmanual.com>

Golf course search by state

<http://golfingnear.com>

Email search by domain

<http://emailbydomain.com>

Auto manuals search

<http://auto.somanuals.com>

TV manuals search

<http://tv.somanuals.com>