



ENGLISH

Condenser Tumble Dryer EDC158 Owner's Manual

IMPORTANT!
To get the best performance
from your dryer, read all
operating instructions before
using it for the first time.

FRANÇAIS

SAVE THESE INSTRUCTIONS FOR FUTURE REFERENCE

ESPAÑOL

CONTENTS

IMPORTANT SAFETY INSTRUCTIONS	3
DESCRIPTION OF THE MACHINE	4
INSTALLATION INSTRUCTIONS	5
INSTRUCTIONS FOR USING THE TUMBLE DRYER	8
CARE LABEL INSTRUCTIONS	9
THE CONTROL PANEL	10
RECOMMENDED PROGRAMS AND TEMPERATURE SETTINGS	11
CARE AND MAINTENANCE INSTRUCTIONS	12
TROUBLESHOOTING	14
WARRANTY	15
QUICK START REFERENCE GUIDE	16

IMPORTANT SAFETY INSTRUCTIONS

WARNING!

To reduce the risk of fire, electric shock, or injury to persons when using your appliance, read the IMPORTANT SAFETY INSTRUCTIONS below:

- ◆ Read all instructions before using the appliance.
- ◆ Do not wash or dry articles that have been previously cleaned in, washed in, soaked in, or spotted with gasoline, dry-cleaning solvents, cooking oils, other flammable or explosive substances as they give off vapors that could ignite or explode.
- ◆ Do not allow children to play on or in the appliance. Children should be closely supervised when near the appliance.
- ◆ Before the appliance is removed from service or discarded, remove the door to the drying compartment.
- ◆ Do not reach into the appliance if the drum is moving.
- ◆ Do not install or store this appliance where it will be exposed to the weather.
- ◆ Do not tamper with controls.
- ◆ Do not attempt to repair or replace any part of the appliance or perform any servicing unless specifically recommended in this guide.
- ◆ Do not use fabric softeners or dryer sheets unless the manufacturer gives written assurance that the product will not damage a tumble dryer.
- ◆ Do not heat-dry items containing:
 - vinyl, plastic, foam rubber or similarly textured rubberlike materials
 - fiberglass
 - wool unless the label specifies "washable"
- ◆ Clean the lint filter before or after each load.
- ◆ Keep the area around the exhaust opening and adjacent surrounding areas free from the accumulation of lint, dust and dirt.
- ◆ The interior of the machine should be cleaned periodically by an authorized Eurotech service agent.
- ◆ Do not place items exposed to cooking oils in your dryer. Items contaminated with cooking oils may contribute to a chemical reaction that could cause a load to catch fire.
- ◆ Electrical installation, if required, must be done by a licensed electrician.
- ◆ Do not operate appliance while away from the home.
- ◆ Do not heat dry items that have been dry-cleaned.

- ◆ The dryer is made and marked to facilitate recycling. When it is no longer useful, contact your local refuse collection service for advice on how to properly dispose of the dryer for purposes of recycling.

WARNING!

This appliance must be properly grounded.

GROUNDING INSTRUCTIONS

A) Grounding instructions for a grounded, cord-connected appliance

In the event of malfunction or breakdown, grounding will reduce the risk of electric shock by providing a path of least resistance for electric current. This appliance is equipped with a cord having an equipment-grounding conductor and a grounding plug. The plug must be plugged into an appropriate outlet that is properly installed and grounded in accordance with all local codes and ordinances.

WARNING!

Improper connection of the equipment-grounding conductor can result in a risk of electric shock. Check with a qualified electrician or service representative or personnel if you are in doubt as to whether the appliance is properly grounded.

Do not modify the plug provided with the appliance. If it will not fit the outlet, have a proper outlet installed by a qualified electrician.

B) Grounding instructions for a permanently connected appliance:

This appliance must be connected to a grounded metal, permanent wiring system, or an equipment-grounding terminal or lead on the appliance.

NOTE: This manual does not cover every possible condition and situation that may occur. Use common sense and caution when installing, operating, and maintaining any appliance.

SAVE THESE INSTRUCTIONS FOR FUTURE REFERENCE

DESCRIPTION OF THE MACHINE

- ◆ The tumble dryer is constructed in sheet steel panels with a treated and painted finish that ensures its aesthetic quality remains unaltered over time.
- ◆ The motor and all moving parts are designed to guarantee minimum noise levels.
- ◆ The stainless steel drum is large and well mounted to ensure a better quality tumble dryer and a longer life of clothing.
- ◆ The control panel lets you use all the drying programs with ease.
- ◆ The door has a wide opening to facilitate easy loading and unloading of the laundry.

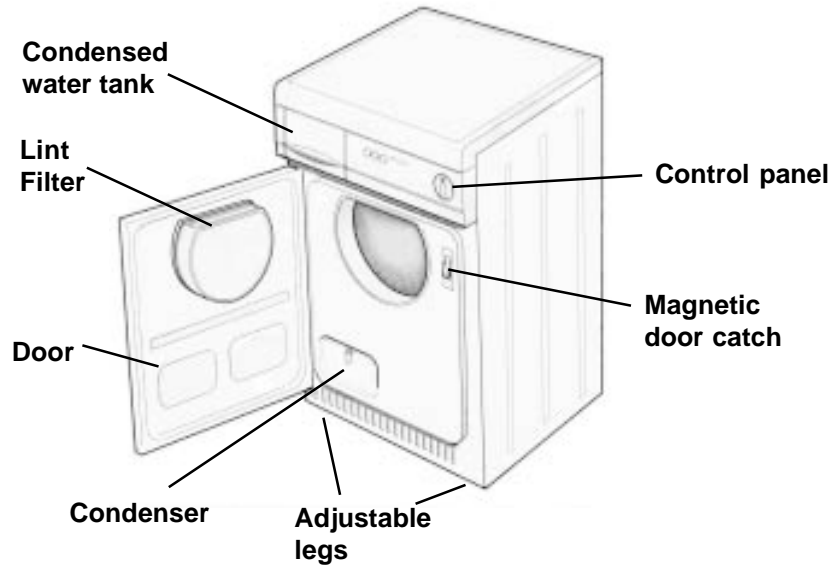

TECHNICAL INFORMATION

Drying system	Internal Condenser
Drum Capacity	106 liters
Voltage	208/230 V, 60 Hz
Heater	2500 W
Weight	Approx . 88 lbs. (39 kg)

DIMENSIONS

Height	33-1/4" (84.45 cm)
Width	23-3/8" (59.37 cm)
Depth w/door closed	22-3/8" (56.83 cm)
Depth w/door open	45-1/8" (114.62 cm)

For additional information, see the type plate located on the door facing.

INSTALLATION INSTRUCTIONS

Read these instructions carefully before you install the machine. The installation should be carried out by a qualified person who is familiar with all local codes and ordinances for electrical connections. Incorrect installation may cause damage and/or injury. If the integrity of the machine is in doubt, do not use it. Call your dealer for qualified assistance.

The dryer can be installed in any room with a hard floor. Do not install it on carpeting with heavy pile.

Make sure the air vents on the front and rear of the machine are not covered.

To install the tumble dryer, follow the steps below:

1. Remove the outer wrapping and the polystyrene base. (Check for any cosmetic damage at this time. See page 15.)
2. Move the machine into place.
3. Adjust the levelling legs by lifting the front of the dryer slightly and adjusting the feet to the correct height. Be careful not to screw the feet down too far and do not use a screwdriver.
NOTE: A badly leveled machine may result in damage to the bearings and premature wear, so we recommend that you use a spirit level.
4. Connect the condensation hose to a drain (optional).

CONNECTING THE CONDENSATION DRAIN HOSE

Your condenser dryer has a tank that collects the condensed water. If you prefer, however, you can install the dryer to drain the water directly to a drain pipe. To do this, follow the steps below:

1. Unplug the dryer from the electrical outlet.
2. Remove the vent on the back of the machine (Fig 1).
3. Remove the clamp and carefully remove the hose (Fig 2).
4. Position the hose on the free inlet and reposition the clamp (Fig 3).
5. Position the hose provided on the front inlet and clamp it into place (Fig 3).
6. Remove the cover from the hole in the vent cover and insert the hose through the hole (Fig 3).
7. Replace the vent cover.
8. Insert the other end of the hose into the drain and secure into place.

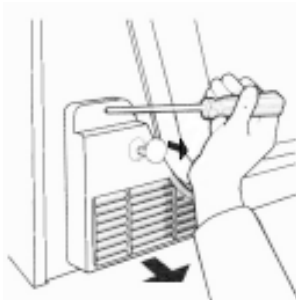

Fig. 1

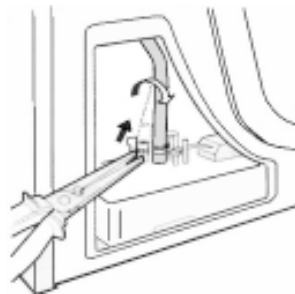

Fig. 2

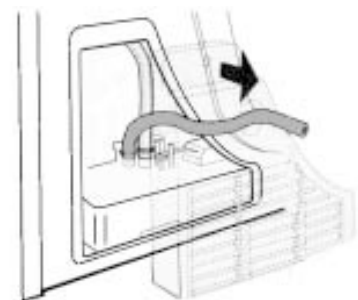

Fig. 3

ELECTRICAL CONNECTIONS

The power supply cord must be grounded. If the machine is to be used in a wet area, the supply must be protected by a residual current device. Connection to a permanently wired supply point must be made only by a qualified electrician.

As supplied: Single-phase, 230 V, 60 Hz, 2500 Watt heater rating, 30 A fuse required

CONNECTING A 3-WIRE POWER CORD

WARNING! Before starting this procedure, be sure the power is turned off at the breaker/fuse box.

You will need a 3-wire power supply cord with three No. 10 copper wires and a matching 3-wire receptacle of NEMA Type 10-30R, as illustrated below:

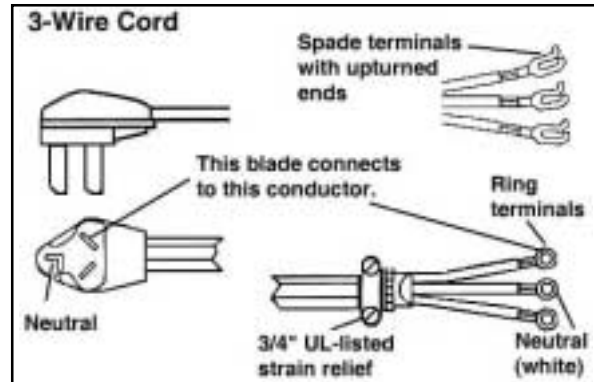

Follow the steps below to connect a 3-wire power cord. (NOTE: The numbers in the illustration correlate to the step numbers.)

1. Turn the power off at the breaker/fuse box.
2. Remove the terminal block cover.
3. Use the strain relief attached below the terminal block opening.
4. Loosen or remove center terminal block screw.
5. Connect neutral (white) wire of power supply cord to the center, silver-colored terminal screw. Tighten screw.
6. Connect the other wires to outer screws.
7. Tighten the strain relief screws.
8. Replace terminal box cover on back of dryer.
9. Plug dryer into wall receptacle.
10. Turn power on at breaker/fuse box.

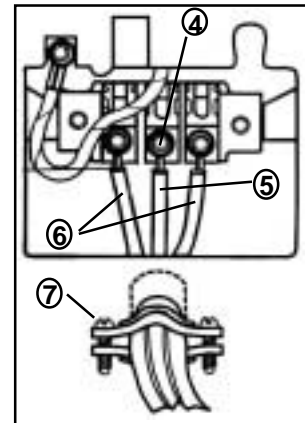

CONNECTING A 4-WIRE POWER CORD

WARNING! Before starting this procedure, be sure the power is turned off at the breaker/fuse box.

You will need a 4-wire power supply cord with four No. 10 copper wires and a matching 4-wire receptacle of NEMA Type 14-30R, as illustrated below. The fourth wire must be identified with a green cover and the neutral conductor by a white cover.

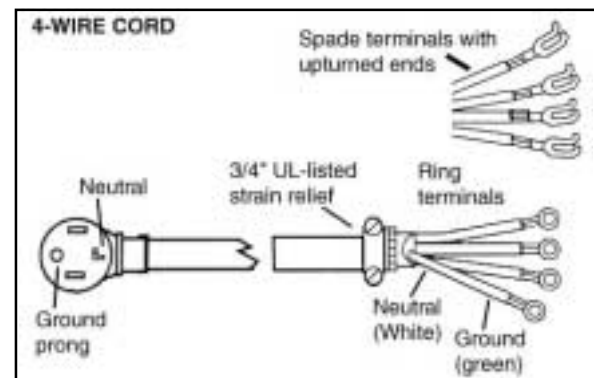

Follow the steps below to connect a 4-wire power cord. (NOTE: The numbers in the illustration correlate to the step numbers.)

1. Turn the power off at the breaker/fuse box.
2. Remove the terminal block cover.
3. Use the strain relief attached below the terminal block opening.
4. Remove center terminal block screw.
5. Remove ground wire (green with yellow stripes) from external ground connector screw. Fasten under center, silver-colored terminal block screw.
6. Connect ground (green) wire of cord to external ground conductor screw.
7. Connect neutral (white) wire of cord under center screw of terminal block.
8. Connect the other wires to outer screws.
9. Tighten the strain relief screws.
10. Replace terminal box cover on back of dryer.
11. Plug dryer into wall receptacle.
12. Turn power on at breaker/fuse box.

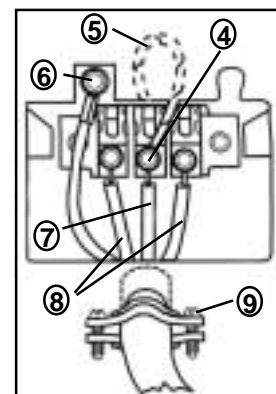

REVERSING THE DOOR HINGES

The door on your Eurotech dryer is delivered to open from the right, but you can reverse the hinges so that it opens from the left. To do this, follow the steps below:

1. Unplug the dryer from the electrical outlet.
2. Supporting the door, remove the bottom left hinge then slide door down and off.
3. Remove the plastic plugs from the right side (A), top and bottom, by pressing the bottom edge of the plug with a screwdriver. Be careful not to scratch the surface of the machine.
4. Screw the hinge into the top right-side hole.
5. Use the plugs you removed from the right-side top and bottom of the door to cover the holes on the left side of the door.
6. Remove the hinges on the right and place them on the left.
7. Remove the plug for the door catch (C).
8. Remove the door catch by pressing a screwdriver against the bottom of the plastic piece (Fig 1).
9. Place the door catch into the left receptacle (C), making sure the electrical connection is positioned properly.
10. Cover the right receptacle (C) with the plug you removed from the left side.
11. Remove the top left hinge and fit it into position on the right side.
12. Reposition the door and fit the bottom hinge into position.
13. Replace the hinge drill hole plugs on the opposite side.

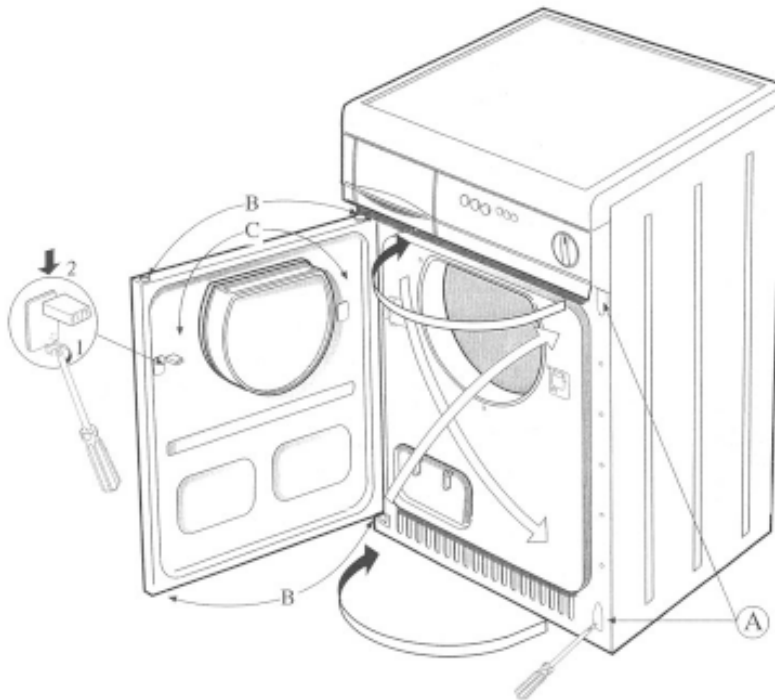

INSTRUCTIONS FOR USING THE TUMBLE DRYER

OPENING THE DOOR

The tumble dryer has a magnetic door catch. To open it, press firmly on the opening side and release (Fig. 1). The door should pop open.

GENERAL INSTRUCTIONS

Below are some general operation instructions. For more detailed information, refer to pages 10 and 11.

1. Make sure the lint filter is free of lint (see page 11).
2. Before placing the items in the dryer, sort the laundry by type of fabric (see below) and care label instructions (see page 9).
3. Make sure nothing is in the garment pockets that could damage the clothes or the machine. Close zippers and hooks to prevent snagging.
4. Load the laundry into the dryer.
5. Close the door securely.
6. Press the On/Off button to turn on the power to the machine (see page 10).
7. Set the Program knob to the desired program (see page 11).
8. Set the Normal/Delicate button to the desired setting (see page 11).

Drying times will vary due to the amount of laundry in the machine, moisture content, type of fabric, air temperature and humidity.



PREPARING THE LAUNDRY

For best drying results, clothes should be sorted properly. Most importantly, you should follow the care label instructions (see page 9). Below are some suggestions on how to best sort your laundry for drying:

- ◆ Permanent press items should be dried together. For the most wrinkle-free results when drying permanent press items, you should fill the machine only half full. These items also should be removed promptly from the dryer and hung up or folded right away.
- ◆ Dry heavy fabrics together and lightweight fabrics together.
- ◆ Dry fabrics that *shed* lint (chenille, terry cloth, etc.) separately from fabrics that *collect* lint (synthetics, velveteen, corduroy, etc.).
- ◆ Separate non-colorfast fabrics from light-colored items.
- ◆ If the care label says "Wash Separately," the fabric is likely to lose color (excess dye) for the first few washings. To minimize the possibility of the dye transferring to white or lighter colored items, dry new colored garments with items of similar color or alone. Bright reds and oranges on cottons are the dyes most likely to transfer colors.

NOTE: Refer to "Important Safety Instructions" on page 3 for a list of specific materials that should never be put in a tumble dryer.

IMPORTANT:

Metal items (coins, nails, etc.) left in pockets, sharp buckles or similar items could damage the drum. Remove any items of this kind before loading the dryer.

FABRIC SOFTENERS AND DRYER SHEETS

We recommend using a liquid fabric softener in the washer's rinse cycle. We do not recommend using fabric softener sheets in the dryer. Over time, the chemicals on these sheets can build up inside the lint filter and clog the holes that circulate the air.







CARE LABEL INSTRUCTIONS

Most clothes and other washable items have permanent care labels. *Read these labels carefully!* Care label instructions and warnings should be followed for the best cleaning results.







The table below defines the typical symbols used on fabric care labels. (Note: Some manufacturers may use slightly different symbols.)

CARE LABEL SYMBOLS



WASH CYCLE

-  Normal wash setting
-  Permanent Press or Wrinkle Resistant setting
-  Gentle/Delicate setting
-  Hand wash only
-  Do not wash
-  Do not wring. Hang dry, drip dry, or dry flat

WASH WATER TEMPERATURE

-  Maximum water temp 200°F/95°C
-  Maximum water temp 160°F/70°C
-  Maximum water temp 140°F/60°C
-  Maximum water temp 120°F/50°C
-  Maximum water temp 105°F/40°C
-  Maximum water temp 85°F/30°C





BLEACH INSTRUCTIONS

-  Any bleach when needed
-  Only non-chlorine bleach
-  Do not bleach







DRY CLEAN SYMBOL

-  This symbol indicates the fabric should be dry cleaned only.





TUMBLE DRY CYCLE

-  Machine dry
-  Normal setting
-  Permanent Press or Wrinkle Resistant setting
-  Gentle or Delicate setting
-  Do not tumble dry







TUMBLE DRY HEAT SETTING

-  Any heat
-  High heat
-  Medium heat
-  Low heat
-  No heat/Air fluff
-  Do not tumble dry

SPECIAL DRYING INSTRUCTIONS

-  Line dry or hang to dry
-  Drip dry (do not spin or wring)
-  Dry flat
-  Dry in shade.

IRONING INSTRUCTIONS

-  Ironing is necessary
-  High temperature setting
-  Medium temperature setting
-  Low temperature setting
-  Do not iron or press with heat
-  Iron without using steam

THE CONTROL PANEL

The control panel on your Eurotech tumble dryer is easy to understand and simple to operate. Simply turn the control knob clockwise to the desired setting, select the program temperature (delicate or normal), and press the ON/OFF button.

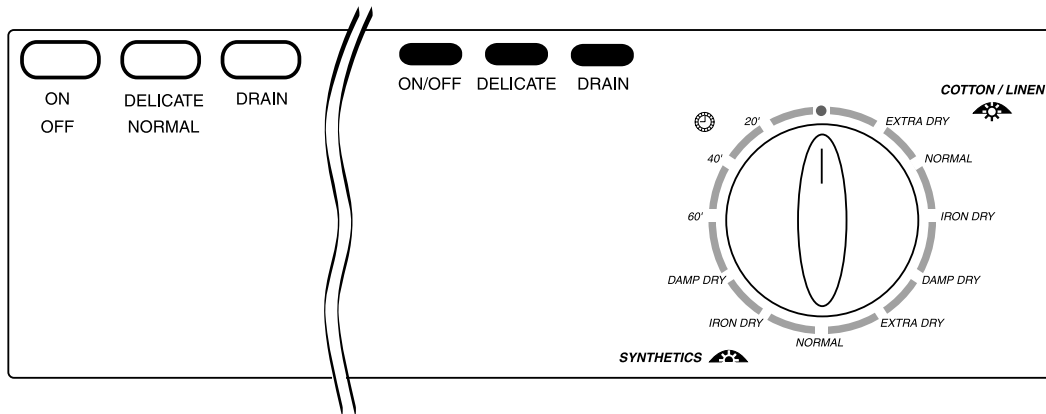

ON/OFF BUTTON AND LIGHT

Press this button to turn the power to the machine on and off. When the power is turned on, the ON/OFF light will flash briefly and a tone will sound. At the end of a program, an end-of-program tone will sound and this light will flash until the door is opened.

If the On/Off light flashes at the start of a program, the Program knob was not turned to the stop position (see below) at the end of the previous program. Turn the Program knob to the stop position and wait for a tone. You can then set the knob to the new program.

DELICATE/NORMAL BUTTON AND LIGHT

This button lets you select between a normal and low drying temperature.

NOTE: Always refer to the care label on the garment to determine if it can be tumble dried. (See page 9.)

Normal: The Normal temperature setting is for sturdy fabrics, such as cotton, linen, and denim. If this button is not pressed in, the temperature setting is Normal. The light will stay lit to indicate the Normal setting is selected.

Delicate: The Delicate temperature setting is for synthetics, such as cotton/polyester blend, rayon, acetate, washable silk or nylon. If this button is pressed in, the temperature setting is Delicate. The light will flash to indicate the dryer is set on Delicate .

DRAIN BUTTON AND LIGHT

If the condensed water tank is full, the Drain light will flash and the dryer will stop. To resume the program, empty the tank and press the drain button for about ten seconds to allow the drain pump to pump the water in the sump area back into the water tank. When the Drain light stops flashing, reset the Program knob to the desired setting to restart the dryer.

PROGRAM KNOB

Turn the Program knob clockwise (right) to the desired setting. The programs on the right of the dial are for cottons and linens. The programs on the bottom are for synthetics. You can also set a timed dry program for 60, 40 or 20 minutes (on top left of dial).

Stop Position – The stop position is where the line on the knob aligns with the dot at the top of the dial. To shut the dryer off, continue to turn the knob clockwise to the stop position.

NOTE: The dryer will not start unless the door is closed securely and there are no items caught between the door and the opening.

COOL-DOWN

Every program ends with a ten-minute cool-down cycle that is designed to reduce wrinkling. This means the clothes will be cool when you remove them from the dryer, rather than scorching hot. During the last cooling stage, the On/Off indicator lamp goes off.

ANTI-CREASE

If the Program knob is not turned to the stop position or the door is not opened at the end of a program, the Anti-crease function begins. This means that the drum rotates the clothes once every minute to prevent creases from setting in. The Anti-crease and end-of-program tone continue until you turn the Program knob to the stop position or open the door to remove the laundry.

END-OF-PROGRAM TONE

At the end of a program, the On/Off light flashes and a tone sounds. Remove the laundry and set the Program knob to the stop position.

INTERRUPTING A PROGRAM

If you wish to interrupt a program to add or remove an item from the dryer, simply open the door. The dryer will tumble for a few seconds before it stops. It will restart when the door is closed. If you leave the door open for more than a few minutes, the power will go off and you will have to reset the program.

CHANGING A PROGRAM

If you decide to change the program setting after you have started the washer, simply turn the knob clockwise to the stop position. Once the light stops flashing, you can set the Program knob to the correct program.

**RECOMMENDED PROGRAMS
AND TEMPERATURE SETTINGS**

The table below is intended to help you determine which program is best for each type of load.

Cottons/Linens			
Fabric Type	Program	Temp Setting	Load Size
Heavy cottons and denims	Extra Dry	Normal	Full
Cottons and linens w/out elastic and/or decorative trim, white and colorfast items	Normal	Normal	Full
Cotton and linen items that require ironing	Iron Dry	Delicate	Half
Cottons and linens with elastic and/or decorative trim	Damp Dry	Delicate	Half
Synthetics			
Fabric Type	Program	Temp Setting	Load Size
Thick polyester/cotton blends	Extra Dry	Normal	Full
White and colorfast perma press	Normal	Delicate	Half
White and colorfast items that require ironing	Iron Dry	Delicate	Half
Polyester/acrylic blends, rayon, acetate	Damp Dry	Delicate	Half
Washable silk and nylon	Damp Dry	Delicate	Third
Timed			
Fabric Type	Program	Temp Setting	Load Size
Heavy cottons and denims	60'	Normal	Full
Cottons and linens w/out elastic and/or decorative trim, white and colorfast items	40'	Normal	Full
White and colorfast perma press	40'	Delicate	Half
White and colorfast items that require ironing	20'	Delicate	Half
Polyester/acrylic blends, rayon, acetate	20'	Delicate	Half
Washable silk and nylon	20'	Delicate	Third

CARE AND MAINTENANCE INSTRUCTIONS

The tumble dryer does not require special care. To best ensure a long life, however, certain precautions are recommended (see also page 3).

CLEANING THE LINT FILTERS

To ensure proper circulation in your tumble dryer and minimize drying times, you should clean the lint filter after every load. To do this, follow the instructions below:

1. Remove the filter on the door from its holder by pulling it upwards (Fig. 1).
2. Gently run your hand across it to collect the lint. If you prefer, you can clean it with a soft brush.
3. Replace the filter into its holder.
4. Clean out the filters in the door opening by running your finger gently across them to collect the lint.

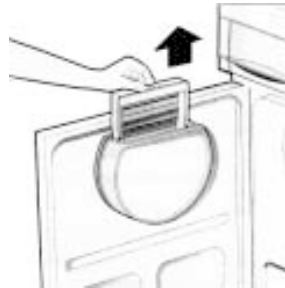

Fig. 1

NOTE: If you use dryer sheets, the lint filter should be washed periodically with a mild soap and water to remove any small particles that may have collected in the holes. Remove the filters from the door by gently prying them out with a flat-head screwdriver (Fig 2).



Fig. 2

EMPTYING THE CONDENSED WATER TANK

WARNING!

Before performing the operations described below, make sure that the power is off and the unit is unplugged.

If the dryer is not installed to pump out the condensed water into a drain or sink, the condensation water collects in the water container to the left of the control panel. You should empty the container every two to three dryer loads, depending on the dampness of the clothes when they go into the dryer.

To empty the container, follow the steps below:

1. Slowly and carefully remove the tank (Fig. 3). Be careful not to tilt the unit and let water spill out.
2. The outlet is on the rear right of the water tank. Empty the water into a sink or drain. (Note: The condensed water is safe to use for watering plants.)
3. Replace the tank into the slot, making sure it is securely in place.

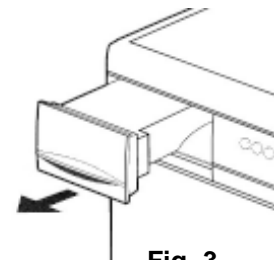

Fig. 3

NOTE: If the water tank fills during a drying cycle, the machine will stop and the Drain indicator light will flash. To resume the program, empty the tank and press the drain button for about ten seconds to allow the drain pump to pump the water in the sump area back into the water tank. When the Drain light stops flashing, reset the Program knob to the desired setting to restart the dryer.

CLEANING THE CONTROL PANEL

WARNING!

Before performing the operations described below, make sure that the power is off and the unit is unplugged.

To clean the control panel, use only a warm, damp cloth. To prevent penetration of liquid into the door lock and electrical components, **never spray water or cleaning solvents on the control panel.**

Also, never use abrasive cleaners or scouring pads on the outer surfaces because they will scratch the finish and could remove the writing on the control panel. Some paper towels may also scratch the finish.

CLEANING THE CONDENSER

The condenser should be cleaned about once a month. If you have pets, you should probably clean it more often. To clean the condenser, follow the steps below:

1. Open the door to access the condenser.
2. Turn the levers on the condenser cover to a vertical position and lift the cover off (Fig. 1).
3. Turn the three levers on the condenser to a vertical position and remove the condenser by grasping the handle and pulling forward (Fig. 2).
4. Spray the filter with warm water until all of the lint is removed (Fig. 3 and 4). Allow the condenser to air dry before replacing it into the unit.

NOTE: Do not put the condenser into a dishwasher. And do not use any sharp metal objects or a wire brush to clean the condenser. Also, do not poke anything between the fins.

5. Make sure the handle is at the bottom and carefully replace the condenser into the unit.
6. Return the three levers on the condenser to a horizontal position to lock the condenser into place.
7. Replace the access door and return those levers to a horizontal position.

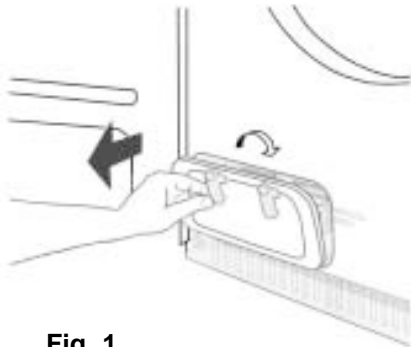

Fig. 1

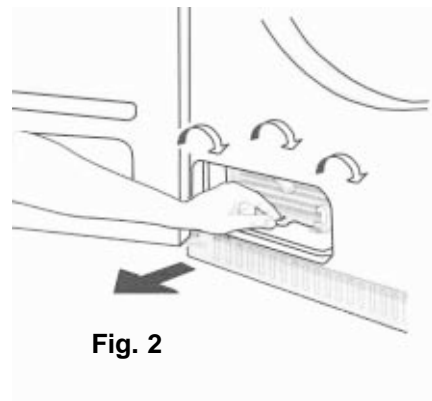

Fig. 2



Fig. 3



Fig. 4

TROUBLESHOOTING

Before calling for technical assistance, check that the operations described below have been carried out correctly. This will save both time and money.

The machine won't start.

- ◆ Make sure the door is closed securely and nothing is caught between the door and the door opening.
- ◆ Make sure you pressed the ON/OFF button.
- ◆ Make sure the ON/OFF indicator light is on.
- ◆ If the ON/OFF light is flashing, turn the Program knob to the stop position (where the line on the knob aligns with the dot at the top of the dial) and wait for a tone. You should then be able to start a new program.
- ◆ Check that you set the program or time correctly.
- ◆ Check that the condenser tank is empty.
- ◆ Check that the electric plug is securely in the socket.
- ◆ Check the house breaker/fuses.

The machine takes too long to dry my laundry.

- ◆ Check that the lint filters on the door and in the door opening are free of lint.
- ◆ If you use dryer sheets, you may need to wash the lint filter with warm water and a soft brush to clean any blocked holes.
- ◆ Be careful not to overload the dryer because the warm air needs sufficient room to circulate properly and the clothes need room to tumble freely.
- ◆ The laundry should only be damp when it comes out of the washer. If it seems too wet, try using a faster or longer spin cycle on the washer.

My clothes are coming out wrinkled.

- ◆ You should remove the clothes as soon as the dryer signals the end of the cycle.
- ◆ Dry heavy fabrics and light fabrics separately.
- ◆ Dry only permanent press items together.
- ◆ Dry in smaller loads.
- ◆ Use slower spin speeds on the washer.
- ◆ Use fabric softener in the rinse program.
- ◆ You may be using the wrong wash temperature. Try using a lower wash temperature, especially for permanent press and delicate items.

The motor is running but the drum isn't turning.

- ◆ This usually means a belt is broken. Call a servicer.

If you think you have resolved the problem, try starting the machine again. If the problem persists, call for technical assistance (see page 15).

BEFORE CALLING FOR SERVICE

Before calling for service or contacting AM Appliance Group regarding a warranty issue, be prepared to explain:

- 1) The model number of the machine
- 2) The serial number of the machine (located on the inner door facing)
- 3) The specific problem

Eurotech PRODUCT WARRANTY

MODEL EDC158

Be sure to complete the Warranty Registration Card you received with your appliance and mail it to AM Appliance Group to validate your appliance warranty.

Cosmetic damage must be reported to your dealer within five days from the date of purchase. After unpacking the washer, thoroughly check the unit for cosmetic damage.

FOR RESIDENTIAL INSTALLATIONS ONLY

LENGTH OF WARRANTY	AM APPLIANCE GROUP WILL PAY FOR:
One-Year Full From date of purchase.	Eurotech replacement parts and/or repair labor to correct defect in materials or workmanship. Service must be provided by an authorized Eurotech service agent.
Two-Year Limited From date of purchase.	Eurotech replacement parts (labor costs not included) for all parts due to defect in materials or workmanship. Service must be provided by an authorized Eurotech service agent.
Five-Year Limited From date of purchase.	Eurotech replacement parts (labor costs not included) for any defective solid-state controls, timers, motors, or pumps. Replacement of cabinets that may have rusted through. Service must be provided by an authorized Eurotech service agent.
Ninety-Nine Year Limited	Eurotech replacement parts (labor costs not included) for the stainless steel inner or outer drum if either fails to hold water due to a manufacturing defect, such as rusting or cracking. Service must be provided by an authorized Eurotech service agent.

AM APPLIANCE GROUP WILL NOT PAY FOR:

- A. Service calls to:
 1. Correct the installation of the appliance.
 2. Repair damage due to shipment, delivery, installation, misuse or abuse.
 3. Instruct how to use the appliance.
 4. Replace house fuses or correct house wiring.
 5. Correct house plumbing, including drain problems related to improper installation.
 6. Clean or service air device in drain line.
- B. Repair and/or replacement parts for failure of product if appliance is used for other than home/residential use.
- C. Damage resulting from accident, fire, floods, acts of God, alteration, misuse, abuse, improper installation, or installation not in accordance with local electrical or plumbing codes.
- D. Any shipping costs for parts during the limited warranty period.
- E. Replacement parts or repair labor costs for units operated outside the continental United States.
- F. Pickup and delivery. Eurotech appliances are designed to be repaired in the home.

IN NO EVENT SHALL AM APPLIANCE GROUP BE RESPONSIBLE FOR ANY INCIDENTAL OR CONSEQUENTIAL DAMAGES.

Some states will not allow the exclusion or limitation of incidental or consequential damages, so this exclusion or limitation may not apply to you. This warranty gives you specific legal rights and you may also have other rights which vary from state to state.

For warranty service, contact the dealer from whom you purchased the unit or an authorized Eurotech service agent. Service will be provided during normal business hours. Should you have a service problem that cannot be resolved locally, contact AM Appliance Group at the numbers listed below. Before calling for service or contacting AM Appliance Group regarding a warranty issue, make a note of the model, type name, and serial number (see page 14).

Write to us at:
AM Appliance Group
P. O. Box 851805
Richardson, Texas 75085-1805

Or call our
Customer Service Center at
800-898-1879 or 972-238-0794

QUICK START REFERENCE GUIDE

(Refer to pages 10 and 11 for more operating instructions.)

Delicate/Normal Light

This light stays lit when the Normal setting is selected. It flashes to indicate the setting is Delicate.

ON/OFF Light

When the power is turned on, this light flashes briefly and a tone sounds. At the end of a program, it also flashes and a tone sounds.

Drain Light

This light flashes and the dryer stops if the water tank is full. Empty the tank then press the Drain button until the light stops flashing. Reset the program.

ON/OFF Button

Press this button to turn the power to the machine on and off.

Delicate/Normal Button

Press this button to select a low drying temperature. Release this button to select a normal drying temperature.

Drain Button

This light flashes and the dryer stops if the water tank is full. Empty the tank and press the drain button until the drain light stops flashing. Reset the Program knob to the desired setting to restart the dryer.

Program Knob

Turn this knob clockwise (right) to the desired setting. To shut the dryer off, continue to turn the knob clockwise to the stop position (where the line on the knob aligns with the dot at the top of the dial).

RECOMMENDED PROGRAMS AND TEMPERATURE SETTINGS

Cottons/Linens			
Fabric Type	Program	Temp Setting	Load Size
Heavy cottons and denims	Extra Dry	Normal	Full
Cottons and linens w/out elastic and/or decorative trim, white and colorfast items	Normal	Normal	Full
Cotton and linen items that require ironing	Iron Dry	Delicate	Half
Cottons and linens with elastic and/or decorative trim	Damp Dry	Delicate	Half
Synthetics			
Fabric Type	Program	Temp Setting	Load Size
Thick polyester/cotton blends	Extra Dry	Normal	Full
White and colorfast perma press	Normal	Delicate	Half
White and colorfast items that require ironing	Iron Dry	Delicate	Half
Polyester/acrylic blends, rayon, acetate	Damp Dry	Delicate	Half
Washable silk and nylon	Damp Dry	Delicate	Third
Timed			
Fabric Type	Program	Temp Setting	Load Size
Heavy cottons and denims	60'	Normal	Full
Cottons and linens w/out elastic and/or decorative trim, white and colorfast items	40'	Normal	Full
White and colorfast perma press	40'	Delicate	Half
White and colorfast items that require ironing	20'	Delicate	Half
Polyester/acrylic blends, rayon, acetate	20'	Delicate	Half
Washable silk and nylon	20'	Delicate	Third

Free Manuals Download Website

<http://myh66.com>

<http://usermanuals.us>

<http://www.somanuals.com>

<http://www.4manuals.cc>

<http://www.manual-lib.com>

<http://www.404manual.com>

<http://www.luxmanual.com>

<http://aubethermostatmanual.com>

Golf course search by state

<http://golfingnear.com>

Email search by domain

<http://emailbydomain.com>

Auto manuals search

<http://auto.somanuals.com>

TV manuals search

<http://tv.somanuals.com>