

# ZEUS

PXA270 RISC based  
EPIC Single Board Computer  
Technical Manual



## Definitions

Eurotech is the trading name for Eurotech Ltd.

## Disclaimer

The information in this manual has been carefully checked and is believed to be accurate. Eurotech assumes no responsibility for any infringements of patents or other rights of third parties, which may result from its use.

Eurotech assumes no responsibility for any inaccuracies that may be contained in this document. Eurotech makes no commitment to update or keep current the information contained in this manual.

Eurotech reserves the right to make improvements to this document and/or product at any time and without notice.

## Warranty

This product is supplied with a 3 year limited warranty. The product warranty covers failure of any Eurotech manufactured product caused by manufacturing defects. The warranty on all third party manufactured products utilized by Eurotech is limited to 1 year. Eurotech will make all reasonable effort to repair the product or replace it with an identical variant. Eurotech reserves the right to replace the returned product with an alternative variant or an equivalent fit, form and functional product. Delivery charges will apply to all returned products. Please check [www.eurotech-ltd.co.uk/support](http://www.eurotech-ltd.co.uk/support) for information about Product Return Forms.

## Trademarks

ARM and StrongARM are registered trademarks of ARM Ltd.

Intel and XScale are trademarks or registered trademarks of Intel Corporation or its subsidiaries in the United States and other countries.

CompactFlash is the registered trademark of SanDisk Corp.

Bluetooth is a registered trademark of Bluetooth SIG, Inc.

ZigBee is a registered trademark of the ZigBee Alliance.

All other trademarks recognised.

## Revision History

<i>Manual</i>	<i>PCB</i>	<i>Date</i>	<i>Comments</i>
Issue A	V1 Issue 2	8 <sup>th</sup> July 2006	First full release of Manual for ZEUS.
Issue B	V1 Issue 3	14 <sup>th</sup> November 2006	Updated to reflect PCB changes, plus other updates.
Issue C	V1 Issue 4	25 <sup>th</sup> April 2007	Updated to reflect PCB changes.
Issue D	V1 Issue 5	1 <sup>st</sup> October 2007	Minor text corrections, Eurotech rebranding.

© 2007 Eurotech Ltd.

For contact details, see page [97](#).



ISO 9001  
FM12961

## Contents

Product handling and environmental compliance .....	5
Introduction .....	6
ZEUS 'at a glance' .....	8
ZEUS features .....	10
ZEUS support products.....	13
About this manual .....	14
Conventions.....	14
Getting started .....	16
Using the ZEUS .....	16
Detailed hardware description .....	18
ZEUS block diagram.....	18
ZEUS address map .....	19
PXA270 processor.....	20
PXA270 GPIO pin assignments.....	22
Interrupt assignments .....	28
On-Board GPIO expanders pin assignments.....	29
Real time clock .....	31
Watchdog timer.....	32
Memory.....	33
Wireless support.....	35
Expansion interfaces.....	38
SDIO .....	39
CompactFlash.....	40
PC/104 interface .....	41
Flat panel display .....	44
Audio.....	49
Touchscreen controller.....	50
USB .....	51
Ethernet .....	52
Serial COM ports .....	53
CAN bus .....	57
I <sup>2</sup> C bus .....	58
Quick Capture camera interface .....	59
External General purpose I/O .....	60
Temperature sensor.....	61
JTAG and debug access.....	62
Power and power management.....	63
Power supplies .....	63
Processor power management.....	66
Peripheral devices power management.....	68
Connectors, LEDs and jumpers .....	74
Connectors .....	76
Jumpers .....	93
Status LEDs .....	96
Appendix A - Contacting Eurotech .....	97

Appendix B - Specification .....	98
Appendix C - Mechanical diagram .....	100
Appendix D - Reference information.....	102
Appendix E - Wireless modem datasheets .....	104
Appendix F - ZEUS Modem details.....	118
Appendix G - ZEUS-FPIF details .....	122
Appendix H - ZEUS-FPIF-CRT details.....	127
Appendix H - Acronyms and abbreviations .....	130
Appendix I - RoHS-6 Compliance - Materials Declaration Form.....	132
Index .....	133

# Product handling and environmental compliance

## *Anti-static handling*

This board contains CMOS devices that could be damaged in the event of static electricity being discharged through them. At all times, please observe anti-static precautions when handling the board. This includes storing the board in appropriate anti-static packaging and wearing a wrist strap when handling the board.

## *Packaging*

Please ensure that, should a board need to be returned to Eurotech Ltd, it is adequately packed (preferably in the original packing material).

## *Electromagnetic compatibility (EMC)*

The ZEUS is classified as a component with regard to the European Community EMC regulations and it is the user's responsibility to ensure that systems using the board are compliant with the appropriate EMC standards.



## *RoHS compliance*

The European RoHS Directive (Restriction on the Use of Certain Hazardous Substances – Directive 2002/95/EC) limits the amount of six specific substances within the composition of the product. The ZEUS and associated accessory products are available as RoHS-6 compliant options and are identified by an -R6 suffix in the product order code. A full RoHS Compliance Materials Declaration Form is included in [Appendix I - RoHS-6 Compliance - Materials Declaration Form](#). Further information about RoHS compliance is available on the Eurotech Ltd web site at [www.eurotech-ltd.co.uk/RoHS and WEEE](http://www.eurotech-ltd.co.uk/RoHS_and_WEEE).

## Introduction

The ZEUS is an ultra-low power, high performance, single board computer based on the PXA270 processor. The PXA270 is an implementation of the Intel XScale micro architecture, combined with a comprehensive set of integrated peripherals including:

- Flat panel graphics controller.
- Interrupt controller.
- Real time clock.
- Various serial interfaces.

The ZEUS board is based on the EPIC form factor. Included as standard are:

- 2 Ethernet ports.
- 2 USB host ports.
- 7 serial ports.

The ZEUS includes a site for a variety of wireless modems and a GPS receiver, and is designed to create cost effective solutions in asset monitoring, asset tracking, mobile terminals and network communication controllers. The ZEUS also includes an onboard vehicle compatible DC/DC power supply to simplify system integration.

The board is available in the standard variants specified in the following table:

Variant	Details
<b>ZEUS-M128-F32-001-R6</b>	<p>Main features (all other features are included unless otherwise stated):</p> <ul style="list-style-type: none"> <li>• Onboard DC/DC PSU.</li> <li>• Dual Ethernet ports.</li> <li>• LVDS transmitter.</li> <li>• CAN bus controller.</li> <li>• 520MHz processor.</li> </ul> <p>This variant is included in the Development Kits.</p>
<b>ZEUS-M128-F32-002-R6</b>	<p>Main features (all other features are included unless otherwise stated):</p> <ul style="list-style-type: none"> <li>• Dual Ethernet ports.</li> <li>• LVDS transmitter.</li> <li>• CAN bus controller.</li> <li>• 5V only (No DC/DC PSU).</li> <li>• 520MHz processor.</li> </ul>

*continued...*

Variant	Details
<b>ZEUS-M64-F32-003-R6</b>	<p>Main features (all other features are included unless otherwise stated):</p> <ul style="list-style-type: none"> <li>• 5V only (No DC/DC PSU).</li> <li>• No CAN bus, LVDS or secondary Ethernet port.</li> <li>• 520MHz processor.</li> </ul>
<b>ZEUS-M128-F32-004-I-R6*</b>	<p>Main features (all other features are included unless otherwise stated):</p> <ul style="list-style-type: none"> <li>• Industrial temperature range (-40°C to +85°C).</li> <li>• 5V only (No DC/DC PSU).</li> <li>• 416MHz processor.</li> </ul>
<b>ZEUS-Mx-Fy-zzz-R6</b> <b>ZEUS-Mx-Fy-zzz-I-R6*</b>	<p>Please note:</p> <ul style="list-style-type: none"> <li>• x can be 256, 128 or 64.</li> <li>• y can be 64 or 32.</li> <li>• zzz is a variant number based on different combinations of features.</li> </ul>

---

\* Industrial temperature range: -40°C (-40°F) to +85°C (+185°F). Please contact Eurotech Ltd for availability of industrial temperature options.

The ZEUS board is fully RoHS-6 compliant.

For alternative board configurations, please contact [Eurotech Sales](#) (see page [97](#)).



# ZEUS 'at a glance'

10-30V input option

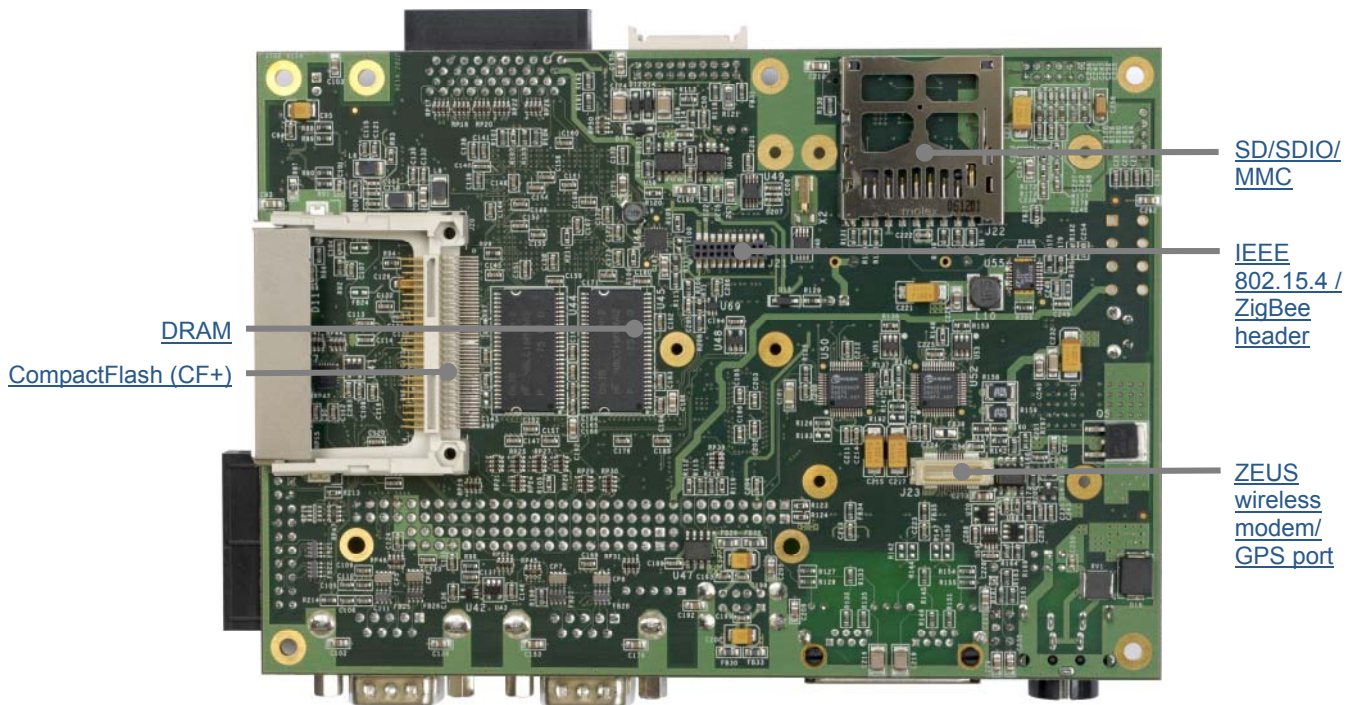
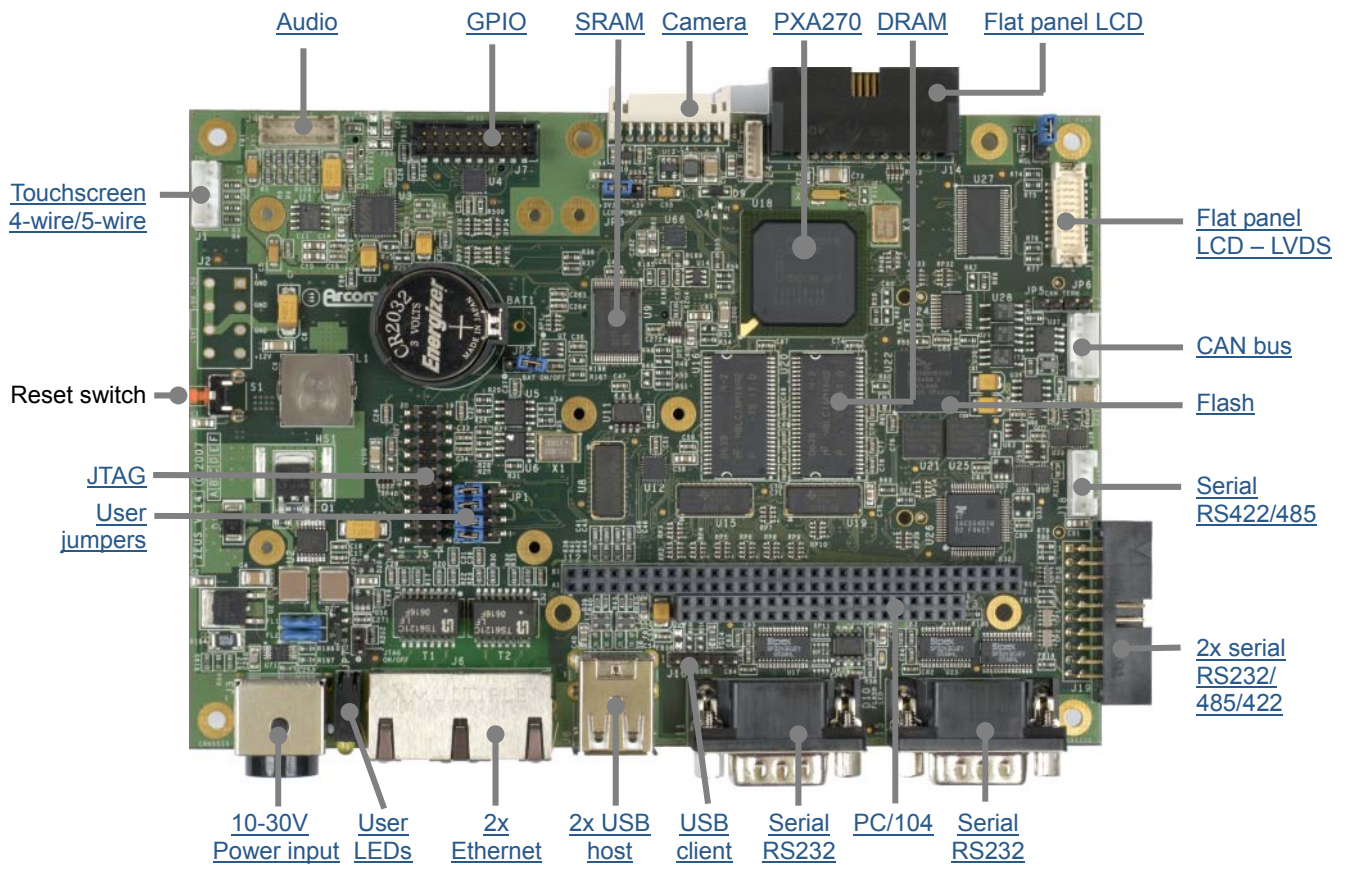



*5V input option*

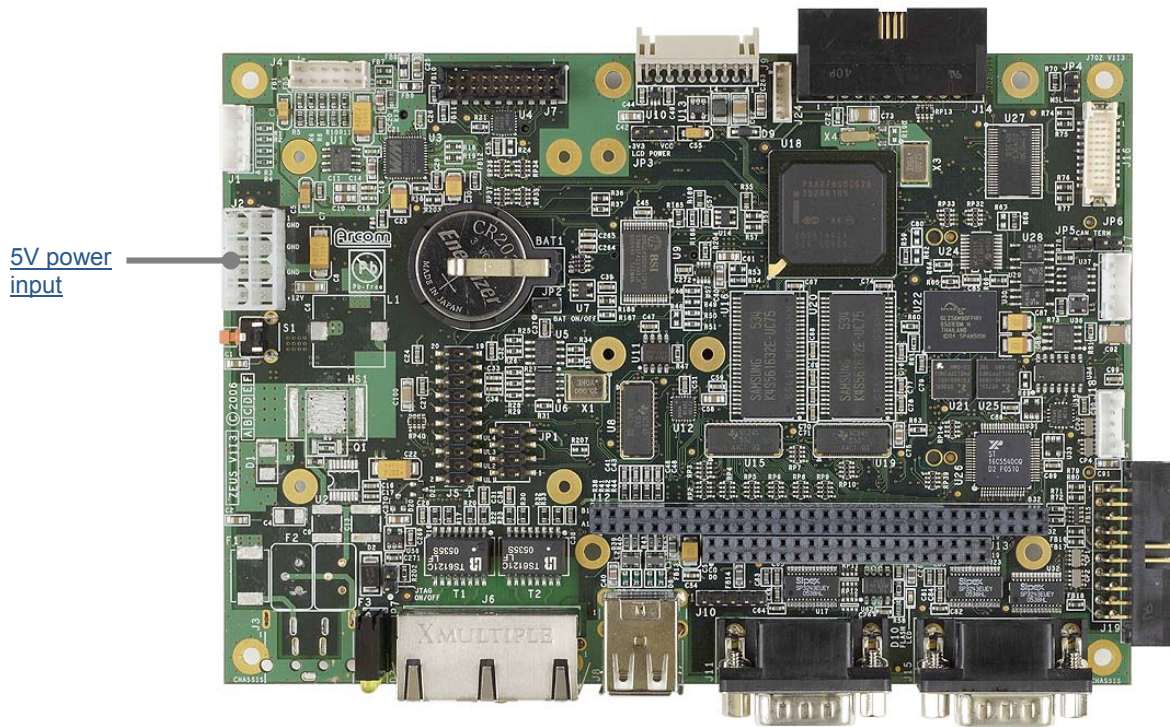

## ZEUS features

### Microprocessor

- PXA270 312/416/520MHz processor (520MHz fitted as standard).

### Cache

- 32K data cache, 32K instruction cache, 2K mini data cache.

### System memory

- Fixed on-board memory:
  - 64/128/256 MB SDRAM (32-bit wide SDRAM data bus).

### Flash memory

- Fixed on-board memory - 32/64MB Flash.

### SRAM

- 256 KB of SRAM battery backed on board.

### Video

- 18-bit flat panel interface for STN and TFT displays.
- Optional LVDS interface.

### Serial ports

- 4x UART fast serial ports - 4x 16550 compatible UARTs (921.6Kbaud):
  - 1x RS422/485 - software selectable.
  - 1x RS232/422/485 - software selectable.
  - 2x RS232.

### Wireless support

- GSM/GPRS, iDEN, CDMA modem and GPS using low profile add-on module.
- IEEE802.15.4 / ZigBee wireless interface using low profile add-on module.

### Network support

- 2x 10/100Base-T Ethernet controllers (Davicom DM9000A).
- On-board dual-port RJ45 jack with LEDs.
- Factory build option for external Power-over-Ethernet (PoE).

### USB support

- 2x USB 1.1 host controller ports supporting 12MB/s and 1.5MB/s speeds.
- Alternatively, one host channel may be configured as a USB 1.1 client controller port supporting 12MB/s and 1.5MB/s speeds.
- Power switch included on board with 500mA current limit.
- 2x USB A-type connectors for host ports.
- Header for client port.

#### Expansion interfaces

- CompactFlash CF+ socket to support Type I,II form factor CF+ cards.
- SDIO socket to support MMC/SD/SDIO cards.
- 16-bit PC/104 interface.

#### Date/time support

- Real time clock – battery backed on-board (external to PXA270).

#### Audio and touchscreen

- Wolfson WM9712L AC'97 compatible CODEC.
- Line in, line out, microphone in, stereo amp out.
- Touchscreen support – 4/5-wire analogue resistive.

#### Quick Capture camera interface

- Intel Quick Capture technology.
- Header connector to a camera image sensor.

#### I<sup>2</sup>C bus

- Multi-master serial bus, header connection.

#### Configuration EPROM

- I<sup>2</sup>C EPROM for storing configuration data.

#### CAN bus

- Optional CAN 2.0B protocol controller and optoisolated transceiver.

#### Watchdog timer

- External to PXA270, generates reset on timeout. Timeout range 1ms-60s.

#### General I/O

- 16 x general purpose I/O (20-pin header).

#### Temperature sensor

- I<sup>2</sup>C temperature sensor.

#### User LEDs

- Front panel user LEDs (3x yellow).

#### Test support

- JTAG interface (standard 20-pin ARM header).

#### Reset

- Reset button.

#### Power requirements

- 5V operation (8-pin ATX style connector) or 10-30V input (front panel DC connector).

### Mechanical

- EPIC form factor (115mm x 165mm).

### Environmental

- Operating temperature:
  - Commercial: -20°C (-4°F) to +70°C (+158°F) for speed variants up to 520MHz.
  - Industrial: -40°C (-40°F) to +85°C (+185°F) for speed variants up to 416MHz.
- RoHS Directive Compliant (2002/95/EC).

## ZEUS support products

The following products support the ZEUS:

- **ZEUS Modem Board 1**, a low profile module attached to the solder side of the ZEUS main board. It provides the following wireless connectivity options:
  - Quad band GSM/GPRS: Sony Ericsson GR64 or Dual band Siemens MC39i module.
  - iDEN: Motorola iO270 module (includes internal GPS receiver).
  - GPS: Fastrax iTRAX0312 channel GPS receiver module.See [ZEUS Modem Board 1](#), page [118](#), for further details.
- **ZEUS Modem Board 2**, a low profile module attached to the solder side of the ZEUS board. It provides the following wireless connectivity:
  - Quad band GSM/GPRS: TELIT GE863-GPS module (includes internal GPS receiver).See [ZEUS Modem Board 2](#), page [118](#), for further details.
- **ZEUS Modem Board 3**, a low profile module attached to the solder side of the ZEUS main board. It provides the following wireless connectivity:
  - GSM/GPRS: SierraWireless MC8780/MC8775/MC8755 modules.
  - CDMA: SierraWireless MC5720/MC5725 modules.
  - GPS: Fastrax iTRAX0312 channel GPS receiver module.See [ZEUS Modem Board 3](#), page [119](#), for further details.
- **ZigBee module (ZMx)**, a direct plug-in option for the ZEUS board that provides ZigBee (see [www.zigbee.org](http://www.zigbee.org)) and IEEE 802.15.4 compatible wireless connectivity. It provides a fully functioning IEEE802.15.4 / ZigBee controller.  
See [IEEE802.15.4 / ZigBee module \(ZMx\)](#), page [37](#), for further details.
- **ZEUS-FPIF** (Flat Panel Interface), a simple board that enables easy connection between the ZEUS and a variety of LCD flat panel displays.  
See [ZEUS-FPIF](#), page [122](#), for further details.
- **ZEUS-FPIF-CRT**, a board that allows the ZEUS to drive a CRT Monitor or an analogue LCD flat panel. Sync on green and composite sync monitors are not supported.  
See [ZEUS-FPIF-CRT](#), page [127](#), for further details.

Contact [Eurotech Sales](#), page [97](#), for further information about any of the above products.







# About this manual

This manual describes the operation and use of the ZEUS single board computer. It is designed to be a reference and user manual and includes information about all aspects of the board.

## Conventions

### Symbols

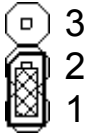
The following symbols are used in this guide:

Symbol	Explanation
	Note - information that requires your attention.
	Tip - a handy hint that may provide a useful alternative or save time.
	Caution – proceeding with a course of action may damage your equipment or result in loss of data.
	Jumper is fitted.
	Jumper is not fitted.
	Jumper fitted on pins 1-2.
	Jumper fitted on pins 2-3.



### Tables

With tables such as that shown below, the white cells show information relevant to the subject being discussed. Grey cells are not relevant in the current context.

Byte lane	Most significant byte								Least significant byte							
Bit	15	14	13	12	11	10	9	8	7	6	5	4	3	2	1	0
Field	-	-	-	-	-	-	-	-	-	-	-	-	-	RETRIG	AUTO CLR	R_DIS
Reset	X	X	X	X	X	X	X	X	0	0	0	0	0	0	0	0

Relevant information

## Getting started

A *ZEUS Quickstart Manual* is provided with each Development Kit to enable you to set up and start using the ZEUS board. Please read the relevant manual and follow the steps explaining how to set up the board. Once you have completed this task, and your ZEUS system is working, you can start adding further peripherals enabling development to begin.

This section explains how to set up and use some of the features of the ZEUS. For more detailed information on any aspect of the board see the section [Detailed hardware description](#), page [18](#).

## Using the ZEUS

### *Using the CompactFlash socket*

The ZEUS is fitted with a Type I/II CompactFlash socket mounted on the solder side of the board. The socket is connected to Slot 0 of the PXA270 PC card interface. It supports 3.3V Type I and II CompactFlash cards, for both memory and I/O. The ZEUS supports hot swap changeover of the cards and notification of card insertion.

For more details see [Expansion interfaces](#), page [38](#).



5V CompactFlash cards are not supported.

---

### *Using the serial interfaces (RS232/422/485)*

The four standard serial port interfaces on the ZEUS are fully 16550 compatible. Connection to the serial ports is made via two DB9 connectors, a 20-way header and a simple 5 way header. The pin assignment of the 20 way header has been arranged to enable 9-way IDC D-Sub plugs to be connected directly to the cable. See the section [J19 – Serial ports – COM3/4](#), page [88](#), for pin assignments and connector details.

See the section [Serial COM ports](#), page [53](#), for further details.

### *Using the audio features*

There are four audio interfaces supported on the ZEUS: amp out, line out, line in and microphone. The line in, line out and amp interfaces support stereo signals and the microphone provides a mono input. The amplified output is suitable for driving an 8Ω load with a maximum power output of 250mW per channel.

Connections are routed to J11. See the sections [Audio](#), page [49](#), and [J4 – Audio connector](#), page [79](#), for further details.

### *Using the USB ports*

The standard dual USB type 'A' connector is provided on the front panel. See the sections [USB](#), page [51](#), and [J8 – USB connector](#), page [81](#), for further details.

### *Using the Ethernet interface*

The boot loader configures the Davicom DM9000A 10/100BaseTX Ethernet controller. Connection is made via a dual RJ45 connector. See the sections [Ethernet](#), page 52, and [J6 – Ethernet connector](#), page 80, for further details.

### *Using the PC/104 expansion bus*

PC/104 modules can be used with the ZEUS to add extra functionality to the system. This interface supports 8/16 bit ISA bus style peripherals.

Eurotech Ltd has a wide range of PC/104 modules, which are compatible with the ZEUS. These include modules for digital I/O, analogue I/O and motion control. Please contact [Eurotech Sales](#) (see page 97) if a particular interface you require does not appear to be available as these modules are in continuous development.

In order to use a PC/104 board with the ZEUS it should be plugged into J12 for 8-bit cards and J12/J13 for 8/16-bit cards. See the sections [ZEUS PC/104 interface details](#), page 41, and [J12 & J13 – PC/104 connectors](#), page 84, for further details.

The ISA interface on the ZEUS does not support DMA, shared interrupts and some access modes. See the section [PC/104 interrupts](#), page 42, for details about PC/104 interrupt use.

The ZEUS provides +5V to a PC/104 add-on board via the J12 and J13 connectors. If a PC/104 add-on board requires a +12V supply, then +12V must be supplied to the ZEUS power connector J2 pin 4. If –12V or –5V are required, these must be supplied directly to the PC/104 add-on board.

### *Using the ZEUS Modem Modules*

The ZEUS Modem modules can be used with the ZEUS to add wireless and GPS functionality to the system. Various wireless modems are supported to provide packet data, circuit switched data and voice connectivity on a wireless network. A 12 channel GPS receiver is also available on the ZEUS Modem module. The ZEUS Modem module is fitted on the solder side of the ZEUS board (connector J23).

The FFUART serial port of PXA270 is used to communicate with the wireless modem, and STUART is used to communicate with GPS module. See the sections [Wireless modem and GPS receiver](#), page 35, and [J23 – Wireless modem/GPS module interface](#), page 91, for further details.

### *Using the ZigBee Module*

The ZEUS ZigBee module can be used with the ZEUS to provide ZigBee ([www.zigbee.org](http://www.zigbee.org)) and IEEE 802.15.4 compatible wireless connectivity. The BTUART serial port of PXA270 is used to communicate with the ZigBee module. The ZigBee module is fitted on the solder side of the ZEUS board (connector J21). For further details, see sections [IEEE802.15.4 / ZigBee module](#), page 37.

# Detailed hardware description

This section provides a detailed description of the functions provided by the ZEUS. This information may be required during development after you have started adding extra peripherals, or are starting to use some of the embedded features.

## ZEUS block diagram

The following diagram illustrates the functional organization of the ZEUS EPIC single board computer:

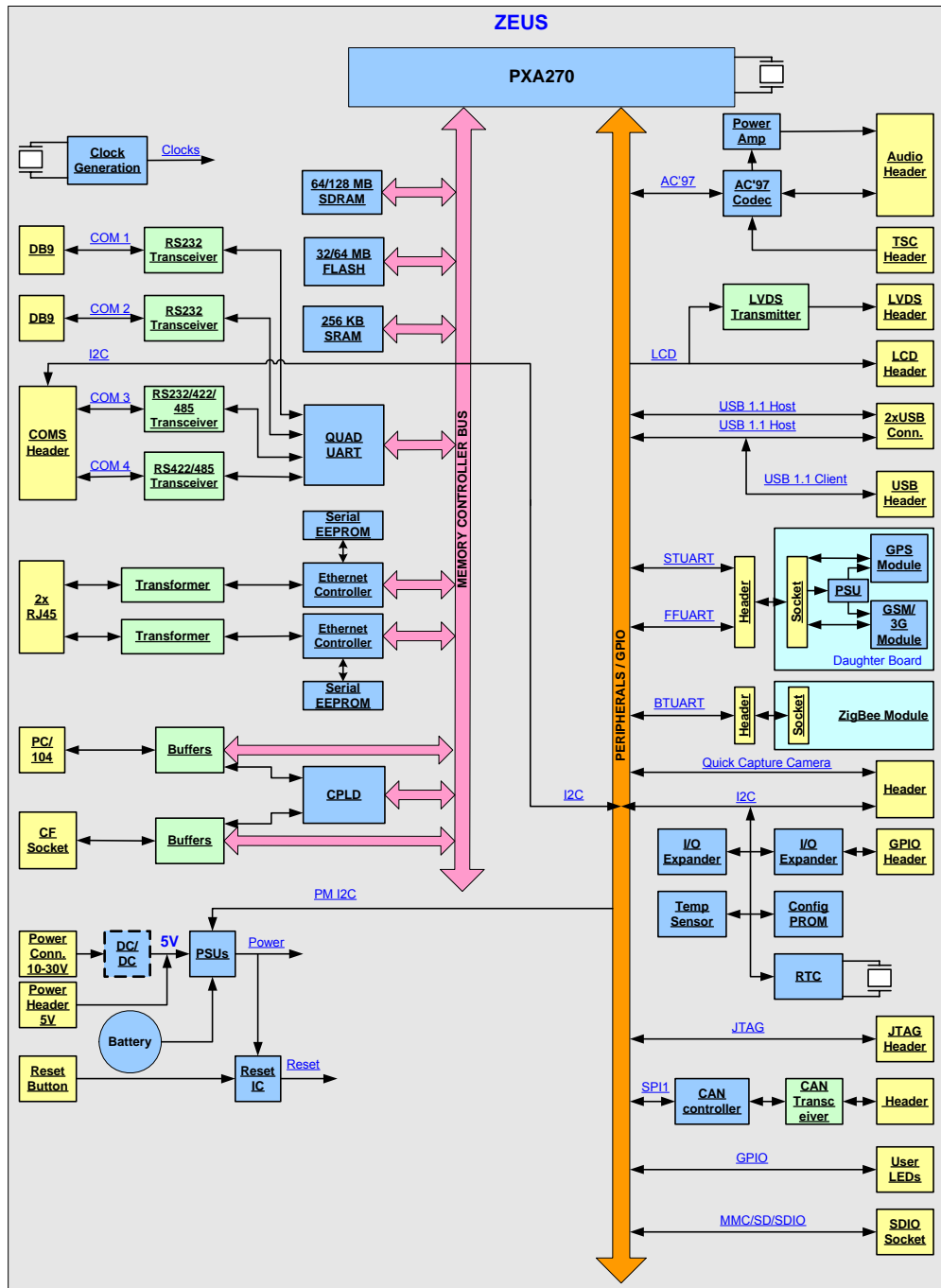

## ZEUS address map

PXA270 chip select	Physical address	Bus width	Description
CS0#	0x00000000 – 0x03FFFFFFE	16-bit	Flash memory/Silicon disk
CS1#	0x04000000 – 0x07FFFFFFE	16-bit	Ethernet controller 0
CS2#	0x08000000 – 0x0BFFFFFFE	16-bit	Ethernet controller 1
CS3#	0x0C000000 – 0x0FFFFFFF	-	Reserved
CS4#	0x10000000 – 0x11FFFFFFE	16-bit	Quad UART
	0x12000000 – 0x13FFFFFFE	16-bit	CPLD registers
CS5#	0x14000000 – 0x17FFFFFFE	16-bit	SRAM
-	0x18000000 – 0x1FFFFFFF	-	Reserved
-	0x20000000 – 0x2FFFFFFE	16-bit	CompactFlash
-	0x30000000 – 0x300003FF	8/16-bit	PC/104 I/O space
-	0x30000400 – 0x3BFFFFFFF	-	Reserved
-	0x3C000000 – 0x3C1FFFFFFF	8/16-bit	PC/104 memory space
-	0x3C200000 – 0x3FFFFFFF	-	Reserved
-	0x40000000 – 0x43FFFFFFF	32-bit	PXA270 peripherals <sup>1</sup>
-	0x44000000 – 0x47FFFFFFC	32-bit	LCD control registers <sup>1</sup>
-	0x48000000 – 0x4BFFFFFFC	32-bit	Memory controller registers <sup>1</sup>
-	0x4C000000 – 0x4FFFFFFC	32-bit	USB host registers <sup>1</sup>
-	0x50000000 – 0x53FFFFFFC	32-bit	Capture interface registers <sup>1</sup>
-	0x54000000 – 0x57FFFFFFC	32-bit	Reserved
-	0x58000000 – 0x5BFFFFFFC	32-bit	Internal memory control <sup>1</sup>
-	0x5C000000 – 0x5C00FFFC	32-bit	Internal SRAM bank 0
-	0x5C010000 – 0x5C01FFFC	32-bit	Internal SRAM bank 1
-	0x5C020000 – 0x5C02FFFC	32-bit	Internal SRAM bank 2
-	0x5C030000 – 0x5C03FFFC	32-bit	Internal SRAM bank 3
-	0x5C040000 – 0x7FFFFFFF	-	Reserved
SDCS0#	0x80000000 – 0x8FFFFFFF	32-bit	SDRAM (U2/U3)
SDCS1#	0x90000000 – 0x9FFFFFFF	32-bit	SDRAM (U41/U49)

## UART and CPLD address map

PXA270 chip select	Physical address	Bus width	Description
CS4#	0x10000000 – 0x107FFFFFFE	16-bit	<a href="#">UART 1</a>
	0x10800000 – 0x10FFFFFFE	16-bit	<a href="#">UART 2</a>
	0x11000000 – 0x117FFFFFFE	16-bit	<a href="#">UART 3</a>
	0x11800000 – 0x11FFFFFFE	16-bit	<a href="#">UART 4</a>
	0x12000000	16-bit	<a href="#">REG0 (CPLD Ver/Issue)</a>
	0x12800000	16-bit	<a href="#">REG1 (PC104 IRQ status)</a>
	0x13000000	16-bit	<a href="#">REG2 (CF Reset)</a>
	0x13800000	16-bit	<a href="#">REG3 (WD Register)</a>

<sup>1</sup> Details of the internal registers are in the *Intel PXA27x Processor Family Developer's Manual* on the Development Kit CD.

## PXA270 processor

The ZEUS board is based on a PXA270 processor. The PXA270 processor is an integrated system-on-a-chip microprocessor for high performance, low power portable handheld and handset devices. It incorporates the Intel XScale technology with on-the-fly voltage and frequency scaling and sophisticated power management.

The PXA270 processor complies with the ARM Architecture V5TE instruction set (excluding floating point instructions) and follows the ARM programmer's model. The PXA270 processor also supports Intel Wireless MMX integer instructions in applications such as those that accelerate audio and video processing.

The features of the PXA270 processor include:

- Intel XScale core.
- Power management.
- Internal memory - 256KB of on-chip RAM.
- Interrupt controller.
- Operating-system timers.
- Pulse-width modulation unit (PWM).
- Real time clock (RTC).
- General-purpose I/O (GPIO).
- Memory controller.
- DMA controller.
- Serial ports:
  - 3x UART.
  - Fast infrared port.
  - I2C bus port.
  - AC97 Codec interface.
  - I2S Codec Interface.
  - USB host controller (2 ports).
  - USB client controller.
  - 3x synchronous serial ports (SSP).
- LCD panel controller.
- Multimedia card, SD memory card and SDIO card controller.
- Memory stick host controller.
- Mobile scalable link (MSL) interface.
- Keypad interface.
- Universal subscriber identity module (USIM) interface.
- Quick Capture camera interface.
- JTAG interface.
- 356-pin VF-BGA packaging.



The design supports 520MHz, 416MHz and 312MHz speed variants of the PXA270 processor. The standard variant of the ZEUS board is fitted with the 520MHz version of PXA270. The maximum speed available for extended temperature versions of the ZEUS is 416MHz.

A 13MHz external crystal is used to run the PXA270 processor. All other clocks are generated internally in the processor.

The PXA270 processor family provides multimedia performance, low power capabilities and rich peripheral integration. Designed for wireless clients, it incorporates the latest Intel advances in mobile technology over its predecessor, the PXA255 processor. The PXA270 processor features scalability by operating from 104MHz up to 520MHz, providing enough performance for the most demanding control and monitoring applications.

PXA270 is the first Intel Personal Internet Client Architecture (PCA) processor to include Intel Wireless MMX technology, enabling high performance, low power multimedia acceleration with a general-purpose instruction set. Intel Quick Capture technology provides a flexible and powerful camera interface for capturing digital images and video. Power consumption is also a critical component. Wireless Intel SpeedStep technology provides the new capabilities in low power operation.

The processor requires a number of power supply rails. All voltage levels are generated on-board from either the DC/DC PSU or from the single +5V power input. The ZEUS uses a specialized Power Management IC to support Intel SpeedStep technology.

The PXA270 processor is a low power device and does not require a heat sink for operating temperatures up to 85°C (185°F).

## PXA270 GPIO pin assignments

The table below summarizes the use of the 118 PXA270 GPIO pins, their direction, alternate function and active level.

Key:





AF            Alternate function.  
 Dir           Pin direction.  
 Active        Function active level or edge.



For details of pin states during sleep modes and reset see the Pin Usage table in the *Intel PXA27x Processor Family Electrical, Mechanical and Thermal Specification*.

GPIO No	AF	Signal name	Dir	Active	Function	Wake-up source	See section...
0	0	AC97_IRQ	Input		AC97Interrupt	✓	<a href="#">Audio, page 49</a>
1	0	DS_WAKEUP	Input		Reset in case of power failure	✓	
3	0	PWR_SCL	Output		PXA270 Power Manager I <sup>2</sup> C		<a href="#">Power management IC, page 64</a>
4	0	PWR_SDA	Bidir.				
5	N/A	PWR_CAP0	Power				
6	N/A	PWR_CAP1	Power		Dedicated function - To achieve low power during sleep		N/A
7	N/A	PWR_CAP2	Power				
8	N/A	PWR_CAP3	Power				
9	0	UART_INTA	Input		UART 1 Interrupt	✓	
10	0	UART_INTB	Input		UART 2 Interrupt	✓	<a href="#">Serial COM ports, page 53</a>
11	0	UART_INTD	Input		UART 4 Interrupt	✓	
12	0	UART_INTC	Input		UART 3 Interrupt	✓	
13	0	USER_LINK1	Input		User Configurable Input	✓	<a href="#">JP1 – User jumpers, page 93</a>

*continued...*

GPIO						Wake-up	See section...
No	AF	Signal name	Dir	Active	Function	source	
14	0	ETH0_IRQ#	Input		Ethernet 0 Interrupt	✓	<a href="#">Ethernet</a> , page <a href="#">52</a>
15	2	ETH_CS1#	Output	Low	Chip Select 1 – Ethernet 0		<a href="#">Ethernet</a> , page <a href="#">52</a>
16	2	PWM0	Output	See <i>Inverter data sheet</i>	Backlight Brightness On/Off or variable if PWM		<a href="#">LCD backlight brightness control</a> , page <a href="#">47</a>
17	0	ISA_IRQ	Input		'OR' of PC/104 interrupts	✓	<a href="#">PC/104 interrupts</a> , page <a href="#">42</a>
18	0	RESERVED					
19	0	BKLEN	Output	High	LCD Backlight Enable		<a href="#">LCD logic and backlight power</a> , page <a href="#">46</a>
20	0	ISA_RST#	Input		PC104 Reset Indication (IRQ)		<a href="#">ZEUS PC/104 interface details</a> , page <a href="#">41</a>
21	0	LVDS_EN	Output	High	LVDS Transceiver Enable		<a href="#">LVDS interface</a> , page <a href="#">47</a>
22	0	USB_PWE2	Output	High	USB Port 2 Power Enable		<a href="#">USB</a> , page <a href="#">51</a>
23	1	CIF_MCLK	Output	NA	Camera Interface Master Clock		
24	1	CIF_FV	Input	NA	Camera Interface Frame Sync -Vertical		<a href="#">Quick Capture camera interface</a> , page <a href="#">59</a>
25	1	CIF_LV	Input	NA	Camera Interface Line Sync - Horizontal		
26	2	CIF_PCLK	Input	NA	Camera Interface Pixel Clock		
27	0	PTT	Input	High	Push To Talk		<a href="#">ZEUS Modem-1</a> , page <a href="#">118</a>
28	1	AC97_BITCLK	Input		AC97 BIT CLOCK		
29	1	AC97_DIN	Input	NA	AC97 DATA IN		<a href="#">Audio</a> , page <a href="#">49</a>
30	2	AC97_DOUT	Output	NA	AC97 DATA OUT		
31	2	AC97_SYNC	Output		AC97 SYNC		



*continued...*

GPIO No	AF	Signal name	Dir	Active	Function	Wake-up	See section...
						source	
32	2	MMCLK	Output	NA	SDIO Clock		<a href="#">SDIO, page 39</a>
33	2	SRAM_CS5#	Output	Low	Chip Select 5 - SRAM		<a href="#">Static RAM, page 34</a>
34	1	GSM_FFRXD	Input	NA	Modem Receive Data		<a href="#">Wireless modem and GPS receiver, page 35</a>
35	0	CF_CD#	Input		Compact Flash Card Detect IRQ	✓	<a href="#">CompactFlash, page 40</a>
36	1	GSM_FFDCD#	Input	NA	Modem Data Carrier Detect		
37	1	GSM_FFDSR#	Input	NA	Modem Data Sender Ready		
38	1	GSM_FFRI#	Input	NA	Modem Ring Indicator		
39	2	GSM_FFTXD	Output	NA	Modem Transmit Data		<a href="#">Wireless modem and GPS receiver, page 35</a>
40	2	GSM_FFDTR#	Output	NA	Modem Data Terminal Ready		
41	2	GSM_FFRTS#	Output	NA	Modem Request To Send		
42	1	ZB_BTRXD	Input	NA	ZigBee Receive Data		
43	2	ZB_BTTXD	Output	NA	ZigBee Transmit Data		<a href="#">IEEE802.15.4 / ZigBee module, page 37</a>
44	1	ZB_BTCTS#	Input	NA	ZigBee Clear To Send		
45	2	ZB_BTRTS#	Output	NA	ZigBee Request To Send		
46	2	GPS_STDRXD	Input	NA	GPS Receive Data		<a href="#">Wireless modem and GPS receiver, page 35</a>
47	1	GPS_STDTXD	Output	NA	GPS Transmit Data		
48	2	CB_POE#	Output	Low	Card Bus Output Enable		
49	2	CB_PWE#	Output	Low	Card Bus Write Enable		<a href="#">Expansion interfaces, page 38</a>
50	2	CB_PIOR#	Output	Low	Card Bus I/O Read		
51	2	CB_PIOW#	Output	Low	Card Bus I/O Write		

*continued...*





GPIO		Signal name	Dir	Active	Function	Wake-up source	See section...
No	AF						
52	0	MMC_WP	Input	Low	SDIO Write Protect Status		
53	0	MMC_CD	Input		SDIO Card Detect IRQ	✓	<a href="#">SDIO, page 39</a>
54	2	CB_PCE2#	Output	Low	Card Bus High Byte Enable		
55	2	CB_PREG#	Output	Low	Card Bus Register Space Select		<a href="#">Expansion interfaces, page 38</a>
56	1	CB_WAIT#	Input	Low	Card Bus WAIT#		
57	1	CB_PIOIS16#	Input	Low	Card Bus IOIS16#		
58	2	LCD_D0	Output	NA	LCD Data Bit 0		
59	2	LCD_D1	Output	NA	LCD Data Bit 1		
60	2	LCD_D2	Output	NA	LCD Data Bit 2		
61	2	LCD_D3	Output	NA	LCD Data Bit 3		
62	2	LCD_D4	Output	NA	LCD Data Bit 4		
63	2	LCD_D5	Output	NA	LCD Data Bit 5		
64	2	LCD_D6	Output	NA	LCD Data Bit 6		
65	2	LCD_D7	Output	NA	LCD Data Bit 7		
66	2	LCD_D8	Output	NA	LCD Data Bit 8		<a href="#">Flat panel display, page 44</a>
67	2	LCD_D9	Output	NA	LCD Data Bit 9		
68	2	LCD_D10	Output	NA	LCD Data Bit 10		
69	2	LCD_D11	Output	NA	LCD Data Bit 11		
70	2	LCD_D12	Output	NA	LCD Data Bit 12		
71	2	LCD_D13	Output	NA	LCD Data Bit 13		
72	2	LCD_D14	Output	NA	LCD Data Bit 14		
73	2	LCD_D15	Output	NA	LCD Data Bit 15		
74	2	LCD_FCLK	Output	NA	LCD Frame Clock (STN) / Vertical Sync (TFT)		
75	2	LCD_LCLK	Output	NA	LCD Line Clock (STN) / Horizontal Sync (TFT)		
76	2	LCD_PCLK	Output	NA	LCD Pixel Clock (STN) / Clock (TFT)		
77	2	LCD_BIAS	Output	NA	LCD Bias (STN) / Data Enable (TFT)		

*continued...*

GPIO No	AF	Signal name	Dir	Active	Function	Wake-up	See section...
						source	
78	2	ETH_CS2#	Output	NA	Chip Select 2 - Ethernet 1		<a href="#">Ethernet</a> , page 52
79	1	CB_PSKTSEL	Output	NA	Card Bus Socket Select		<a href="#">Expansion interfaces</a> , page 38
80	2	CPLD_CS4#	Output	Low	Chip Select 4 – UART/CPLD		<a href="#">UART and CPLD address map</a> , page 19
81	1	SPI_TXD3	Output	NA	SPI Transmit Data		
82	1	SPI_RXD3	Input	NA	SPI Receive Data		
83	1	SPI_CS3#	Output	Low	SPI Chip Select		<a href="#">CAN bus</a> , page 57
84	1	SPI_CLK3	Output	NA	SPI Clock		
85	1	CB_PCE1#	Output	Low	Card Bus Low Byte Enable		<a href="#">Expansion interfaces</a> , page 38
86	2	LCD_D16	Output	NA	LCD Data Bit 16		<a href="#">Flat panel display</a> , page 44
87	2	LCD_D17	Output	NA	LCD Data Bit 17		
88	0	USB_OC1#	Input		USB Port 1 Over Current Detection		<a href="#">USB</a> , page 51
89	0	USB_PWE1	Output	High	USB Port 1 Power Enable		
90	3	CIF_DD4	Input	NA	Camera Interface Data 4		<a href="#">Quick Capture camera interface</a> , page 59
91	0	EX_GPIO_IRQ#	Input		External GPIO Interrupt	✓	<a href="#">External General purpose I/O</a> , page 60
92	1	MMDAT0	Bidir.	NA	SDIO Data 0		<a href="#">Expansion interfaces</a> , page 38
93	2	CIF_DD6	Input	NA	Camera Interface Data 6		<a href="#">Quick Capture camera interface</a> , page 59
94	2	CIF_DD5	Input	NA	Camera Interface Data 5		
95	1	AC97_RST#	Output	Low	AC97 Reset		<a href="#">Audio</a> , page 49
96	0	OVERTEMP	Input		Temperature Sensor Overtemp IRQ		<a href="#">Temperature sensor</a> , page 61

continued...



GPIO No	AF	Signal name	Dir	Active	Function	Wake-up	See section...
						source	
97	0	CF_PWEN	Output	High	Compact Flash Power Enable		<a href="#">CompactFlash</a> , page 40
98	2	CIF_DD0	Input	NA	Camera Interface Data 0		<a href="#">Quick Capture camera interface</a> , page 59
99	0	CF_RDY	Input	NA	Compact Flash Ready/Busy Status Flag		<a href="#">CompactFlash</a> , page 40
100	3	GSM_FFCTS#	Input	NA	Modem Clear To Send		<a href="#">Wireless modem and GPS receiver</a> , page 35
101	0	LCD_EN	Output	High	LCD Logic Supply Enable		<a href="#">Flat panel display</a> , page 44
102	0	USER_LINK2	Input	NA	User Configurable	✓	<a href="#">JP1 – User jumpers</a> , page 93
103	1	CIF_DD3	Input	NA	Camera Interface Data 3		
104	1	CIF_DD2	Input	NA	Camera Interface Data 2		
105	1	CIF_DD1	Input	NA	Camera Interface Data 1		<a href="#">Quick Capture camera interface</a> , page 59
106	1	CIF_DD9	Input	NA	Camera Interface Data 9		
107	1	CIF_DD8	Input	NA	Camera Interface Data 8		
108	1	CIF_DD7	Input	NA	Camera Interface Data 7		
109	1	MMDAT1	Bidir.	NA	SDIO Data 1		
110	1	MMDAT2	Bidir.	NA	SDIO Data 2		<a href="#">Expansion interfaces</a> , page 38
111	1	MMDAT3	Bidir.	NA	SDIO Data 3		
112	1	MMCMD	Bidir.	NA	SDIO Command		
113	0	ETH1_IRQ#	Input		Ethernet 1 Interrupt	✓	<a href="#">Ethernet</a> , page 52
114	0	USB_OC2#	Input		USB Port 2 Overcurrent Detection IRQ		<a href="#">USB</a> , page 51
115	0	IG_FAIL	Input		Ignition Fail IRQ		<a href="#">Power supplies</a> , page 63
116	0	CAN_IRQ#	Input		CAN Bus Interrupt	✓	<a href="#">CAN bus</a> , page 57
117	1	I2C_SCL	Output	NA	I2C Clock		<a href="#">I<sup>2</sup>C bus</a> , page 58
118	1	I2C_SDA	Bidir.	NA	I2C Data		

## Interrupt assignments

### Internal interrupts

For details on the PXA270 interrupt controller and internal peripheral interrupts please see the *Intel PXA27x Processor Family Developer's Manual* on the Development Kit CD.

### External interrupts

The following table lists the PXA270 signal pins used for external interrupts:

PXA270 Pin	Signal name	Peripheral	Wake-up	Active
GPIO0	AC97_IRQ	Audio	✓	
GPIO1	GPIO_IRQ#	External GPIO	✓	
GPIO9	UART_INTA	UART 1	✓	
GPIO10	UART_INTB	UART 2	✓	
GPIO11	UART_INTD	UART 4	✓	
GPIO12	UART_INTC	UART 3	✓	
GPIO13	USER_LINK1	User defined	✓	User defined
GPIO14	ETH0_IRQ#	Ethernet 0	✓	
GPIO17	ISA_IRQ	PC/104	✓	
GPIO20	ISA_RST#	PC/104		
GPIO35	CF_CD#	CompactFlash	✓	
GPIO53	MMC_CD	SDIO	✓	
GPIO88	USB_OC1#	USB1		
GPIO91	USER_LINK2	User defined	✓	User defined
GPIO96	OVERTEMP	Temperature sensor		
GPIO99	CF_RDY	CompactFlash		Ready =  Busy =
GPIO102	USER_LINK2	User defined	✓	User defined
GPIO113	ETH1_IRQ#	Ethernet 1	✓	
GPIO114	USB_OC2#	USB2		
GPIO115	IG_FAIL#	PSU (10-30V)		
GPIO116	CAN_IRQ#	CAN Bus	✓	

## On-Board GPIO expanders pin assignments

Two GPIO expanders (MAX7313) are used to provide additional GPIOs for use with different on-board peripherals. The GPIO expanders are connected to the I<sup>2</sup>C bus of PXA270 and are accessible through I<sup>2</sup>C bus addresses 0x21 and 0x22.

The following tables summarize the use of the 17 GPIO pins of MAX7313 on ZEUS board, and indicate their direction and active level.

### Expander 1 - I2C Address 0x21

GPIO	Signal name	Dir	Active	Function	Power-up state	See section...
0	U3_RS232EN	Output	High	UART3 RS232 enable	PU	
1	U3_RS422EN	Output	High	UART3 RS422 enable	PU	<a href="#">COM3 – RS232/RS485/RS422 interface, page 54</a>
2	U3_TERM#	Output	Low	UART3 termination enable	PU	
3	USER_LED1#	Output	Low	User LED 1	PU	
4	USER_LED2#	Output	Low	User LED 2	PU	<a href="#">User LEDs, page 96</a>
5	USER_LED3#	Output	Low	User LED 3	PU	
6	USER_LINK3	Input	NA	User jumper 3	Jumper	<a href="#">JP1 – User jumpers, page 93</a>
7	NOT USED				PU	
8	GSM_ON	Output	See note 1 below	Modem enable	OD	
9	GSM_STS	Input	High	Modem ON/OFF status	Low	
10	GPS_ON	Output	High	GPS module enable	PU	<a href="#">Wireless modem and GPS receiver, page 35</a>
11	GPS_PSUON	Input	NA	Not Used	PU	
12	GPS_BOOT	Input	NA	Not Used	OD	
13	GPS_PPS	Input	NA	GPS Pulse Per Second	-	
14	USER_LINK4	Input	NA	User jumper 4	Jumper	<a href="#">JP1 – User jumpers, page 93</a>
15	U4_RS485EN	Output	High	UART4 RS485 enable	PU	<a href="#">COM4 – RS422/485 interface, page 55</a>
16	U4_TERM#	Output	Low	UART4 termination enable	PU	

#### Key:

Dir - Pin direction                      Active - Function active level or edge  
 PU - On-board 10K pull-up            OD - Open Drain



Note 1: Please see the datasheet of the particular module used.

**Expander 2 - I2C Address 0x22**

GPIO	Signal name	Dir	Active	Function	Power-up state	See section...
0	CLK_SHDN#	Output	Low	Clock Synthesizer Shutdown	PU	<a href="#">Clock generator power management, page 72</a>
1	LVDS_FES#	Output	Low	LVDS Falling Edge Strobe	PU	<a href="#">LVDS interface, page 47</a>
2	CAN_SHDN	Output	High	CAN Transceiver shutdown	PU	<a href="#">CAN bus, page 57</a>
3	U1_RS232_SHDN#	Output	Low	COM1 RS232 transceiver shutdown	PU	<a href="#">COM Ports power management, page 73</a>
4	U2_RS232_SHDN#	Output	Low	COM2 RS232 transceiver shutdown	PU	
5	U3_RS485_SLO#	Output	Low	COM3 RS485 transceiver slew rate control	PU	<a href="#">COM3 – RS232/RS485/RS422 interface, page 54</a>
6	U4_RS485_SLO#	Output	Low	COM4 RS485 transceiver slew rate control	PU	<a href="#">COM4 – RS422/485 interface, page 55</a>
7	NOT USED				PU	
8-11	ISS [0-3]	Inputs	NA	PCB Issue Number		
12-15	VER [0-3]	Inputs	NA	PCB Version Number		

## Real time clock

The ZEUS uses an external real time clock (RTC) (Intersil ISL1208) to store the date and time, and provide power management events. The RTC is connected to the I<sup>2</sup>C bus of the PXA270 processor and is accessible through I<sup>2</sup>C bus address 0x6F. The RTC is battery backed.

The accuracy of the RTC is based on the operation of the 32.768 KHz watch crystal. The calibration tolerance is  $\pm 20$ ppm, which provides an accuracy of  $\pm 1$  minute per month when the board is operated at an ambient temperature of  $+25^{\circ}\text{C}$  ( $+77^{\circ}\text{F}$ ). When the board is operated outside this temperature the accuracy may be degraded by  $-0.035\text{ppm}/^{\circ}\text{C}^2 \pm 10\%$  typical. The watch crystal's accuracy will age by  $\pm 3$ ppm max in the first year, then  $\pm 1$ ppm max in the year after, and logarithmically decrease in subsequent years.

The Intersil ISL1208 RTC provides the following basic functions:

- Real time clock/calendar:
  - Tracks time in hours, minutes and seconds.
  - Day of the week, day, month and year.
- Single alarm:
  - Settable to the second, minute, hour, day of the week, day or month.
  - Single event or pulse interrupt mode.
- 2 bytes battery-backed user SRAM.
- I<sup>2</sup>C interface.

PXA270 has an internal real time clock, which doesn't keep time after hardware reset, and should only be used as a wake-up source from deep-sleep.

## Watchdog timer

The ZEUS uses an external watchdog timer (MAX6369) which can be used to protect against erroneous software. This is a programmable watchdog timer that can be adjusted for timeout periods of 1ms, 10ms, 30ms, 100ms, 1s, 10s and 60s. The board is reset when timeout occurs. The MAX6369 watchdog timer can be programmed using the WD setup register provided within the CPLD. The register is memory mapped (accessible through CS5#). The WDT is disabled upon reset, and remains so until enabled by the software.

The following table shows the WD setup register bit definitions:

### *Watchdog Register [REG3]*

Bits	Description
7:4	Not used.
3	WDI: Watchdog Input. If WDI remains either high or low for the duration of the watchdog timeout period ( $t_{WD}$ ), WDT triggers a reset pulse. The internal watchdog timer clears whenever a reset pulse is asserted or whenever WDI sees a rising or falling edge.
2:0	WDSET[2:0] – watchdog enable / timeout period setup bits.

Hex Offset Address: 0x13800000

Reset Hex Value: 0x03

Access: Read/write

For further details, see the *Intel PXA27x Processor Family Developer's Manual* on the Development Kit CD.

## Memory

The ZEUS has four types of memory fitted:

- 32 or 64MB resident Flash disk containing:
  - Boot loader to boot operating system.
  - Operating system.
  - Application images.
- 64, 128 or 256MB of SDRAM for system memory.
- Static RAM, as follows:
  - 256KB of SRAM internal to PXA270.
  - 256KB of SRAM external to PXA270 (battery backed).
- 128 bytes of configuration EEPROM on the I<sup>2</sup>C bus.

### *Flash memory*

The ZEUS supports 32MB or 64MB of Spansion (AMD) MirrorBit Flash memory for the boot loader, OS and application images. The Flash memory is arranged as 128Mbit x 16-bit (32MB device) or as 256Mbit x 16-bit (64MB device).

The Flash memory array is divided into equally sized symmetrical blocks that are 64-Kword in size (128KB) sectors. A 256Mbit device contains 256 blocks, and a 512Mbit device contains 512 blocks.

Whenever the Flash memory is accessed the 'Flash' access LED is illuminated.

### *SDRAM*

There are two standard memory configurations supported by the ZEUS: 64MB or 128MB of SDRAM located in banks 0 and 1. The SDRAM is configured as 16MB x 32-bit (64MB), or 32MB x 32-bit (128MB). 64MB configuration is using 2 devices, and 128MB configuration is using 4 devices, each with 4 internal banks of 4MB x 16-bit. Optional 256MB configuration is using 4 devices, each with 4 internal banks of 8MB x 16-bit.

These are surface mount devices soldered to the board. The size of memory fitted to the board is detected by software to configure the SDRAM controller accordingly.

The SDRAM memory controller is set to run at frequency of 104MHz.

*Static RAM*

The PXA270 processor provides 256KB of internal memory-mapped SRAM. The SRAM is divided into four banks, each consisting of 64KB.

The ZEUS also has an external 256KB SRAM device fitted, arranged as 256Kbit x 8-bits. Access to the device is on 16-bit boundaries, whereby the least significant byte is the SRAM data and the 8-bits of the most significant byte are 'don't care' bits. The reason for this is that the PXA270 is not designed to interface to 8-bit peripherals. This arrangement is summarized in the following data bus table:

Most significant byte								Least significant byte							
D15	D14	D13	D12	D11	D10	D9	D8	D7	D6	D5	D4	D3	D2	D1	D0
Don't Care								SRAM Data							

The external SRAM is non-volatile while the on-board coin cell battery is fitted.

*Configuration EEPROM*

The configuration EEPROM is interfaced directly to PXA270's I<sup>2</sup>C controller. It is a Microchip 24AA01 1Kbit EEPROM organized as one block of 128 x 8-bit memory.

The configuration EEPROM is addressable at I<sup>2</sup>C serial bus address 0x50 and is accessed in fast-mode operation at 400KB/s.



## Wireless support

The ZEUS can support various wireless modems, GPS functionality and an IEEE802.15.4 / ZigBee wireless sensor network interface. This is achieved using two optional add-on modules. GPS and cellular functionality are integrated on a single module (ZEUS Modem-n) while the IEEE802.15.4 / ZigBee port is provided by a separate module. Other cellular wireless modems such as EVDO, EDGE or satellite modems may be supported via this interface. Please contact [Eurotech Sales](#) (see page [97](#)) for more information about the available options.

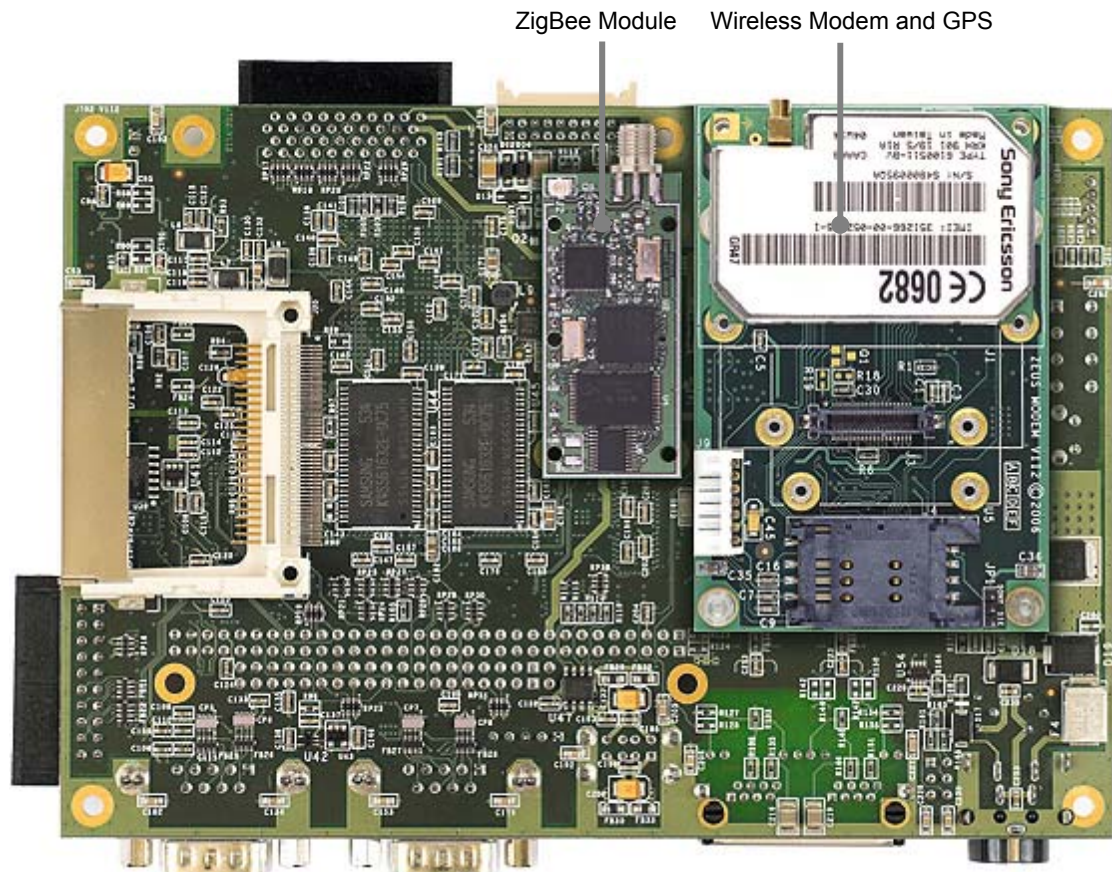

### *Wireless modem and GPS receiver*

Various wireless modems are supported to provide packet data, circuit switched data and voice connectivity on a wireless network. ZEUS also provides complete GPS functionality including position, velocity and time (PVT). The ZEUS modem module is fitted on the solder side of the ZEUS board (connector J23).

The wireless modem is driven by the FFUART serial port (within the PXA270), while the GPS module uses the STUART serial interface (Rx/Tx only). For the connector details, see the section [J23 – Wireless modem/GPS module interface](#), page [91](#).

There are also a number of control/status GPIO signals connected to J23. They can be accessed through a GPIO Expander MAX7313. See the section [On-Board GPIO expanders pin assignments](#), page [29](#).

ZEUS Modem-1 supports the following modules:

- Sony Ericsson GR64, a quad-band (850/900/1800/1900) version of GR47/48. Functionally comparable to the Sony Ericsson GR47/GR48 devices, the GR64 offers a broad range of voice and data features. The integrated TCP/IP stack enables effective use of GPRS. For further details see [Sony Ericsson GR64](#), page [104](#).
- Siemens MC35i/39i, a dual-band GSM/GPRS module (EGSM 900/1800MHz). For further details see [Siemens MC35i/39i](#), page [106](#).
- Fastrax iTrax03/8, a 12-channel GPS receiver. iTrax03/8 features low power consumption, small footprint, 8Mbit internal Flash and does not require battery backup. For further details see [Fastrax iTrax03/8](#), page [108](#).
- Motorola iO270, a wireless modem that provides packet data, circuit data and voice connectivity on the iDEN 800MHz network. The iO270 include a GPS receiver. For further details see [Motorola iO270](#), page [110](#).

For further details about this modem see the section [ZEUS Modem-1](#), page [118](#).

ZEUS Modem-2 supports the following wireless module with built-in GPS receiver:

- Telit GE863-GPS module, which supports communication services in quad-band EGSM 850/900/1800/1900MHz networks. For further details see [Telit GE863-GPS](#), page [112](#).

For further details about ZEUS Modem-2, see the section [ZEUS Modem-2](#), page [118](#).

ZEUS Modem-3 supports the following wireless modules:

- Sierra Wireless MC8775 PCI Express Mini Card embedded module, which offers connectivity to all three HSDPA/UMTS frequency bands (850, 1900, 2100 MHz) and all four EDGE/GPRS bands (850, 900, 1800 and 1900 MHz) used worldwide. For further details see [Sierra Wireless MC8775](#), page [114](#).
- Sierra Wireless MC5720 PCI Express Mini Card embedded module, which offers a complete wireless data solution over CDMA 1x EVDO networks with typical download data rates of 400-700 kbps. For further details see [Sierra Wireless MC5720](#), page [116](#).
- Fastrax iTrax03/16, a 12-channel GPS receiver. iTrax03/16 features low power consumption, small footprint, 16Mbit internal Flash and does not require battery backup. For further details see [Fastrax iTrax03/8](#), page [108](#).

For further details about ZEUS Modem-3, see the section [ZEUS Modem-3](#), page [119](#).

### *IEEE802.15.4 / ZigBee module (ZMx)*

IEEE802.15.4 / ZigBee is the wireless standards-based technology that addresses the unique needs of remote monitoring and control for sensor level network applications. ZigBee enables deployment of wireless networks with low cost, low power solutions sensor devices and offers the ability to run remote sensors for years on inexpensive primary batteries. For more information, see [www.zigbee.org/en/about/](http://www.zigbee.org/en/about/).

The ZigBee module is connected to the PXA270 processor using BTUART serial interface (Rx, Tx, RTS#, CTS#). For the connector details see the section [J21 – IEEE802.15.4 / ZigBee connector](#), page [90](#).

## Expansion interfaces

There are three expansion interfaces on the ZEUS: SDIO, PC/104 and CompactFlash. PC/104 and CompactFlash interfaces are connected to the PC card memory controller of the PXA270 with the use of some 'glue logic' implemented in a CPLD (Xilinx XC9536XL). There is a CPLD Firmware version/issue register that can be accessed at the address 0x12000000.

### *CPLD ver/issue register [REG0]*

Byte lane	Most significant byte	Least significant byte	
Bit	15 14 13 12 11 10 9 8	[7:4]	[3:0]
Field	- - - - - - - -	VER[3:0]	ISSUE[3:0]
Reset	X X X X X X X X	Current Version	Current Issue
R/W	- - - - - - - -	Read Only	
Address	0x12000000		

## SDIO

The SD card socket J22 is interfaced directly to PXA270's MMC/SD/SDIO controller.

The MMC/SD/SDIO controller supports multimedia card, secure digital and secure digital I/O communications protocols. The MMC controller supports the MMC system, a low cost data storage and communications system. The MMC controller in the PXA270 processor is based on the standards outlined in the *MultiMediaCard System Specification Version 3.2*. The SD controller supports one SD or SDIO card based on the standards outlined in the *SD Memory Card Specification Version 1.01* and *SDIO Card Specification Version 1.0 (Draft 4)*.

The MMC/SD/SDIO controller features:

- Data transfer rates up to 19.5Mbit/s for MMC, 1-bit SD and SPI mode data transfers, and up to 9.75Mbit/s for 1-bit SDIO.
- Data transfer rates up to 78Mbit/s for 4-bit SD data transfers, and up to 39Mbit/s for SDIO.
- Support for all valid MMC and SD/SDIO protocol data transfer modes.

This is a hot swappable 3.3V interface, controlled by the detection of a falling edge on GPIO53 when an SD card has been inserted, and a rising edge when an SD card is removed.

SD card write protection is connected to PXA270's GPIO52, and card detect to GPIO53.

A variety of SDIO cards are available, such as a Bluetooth and IEEE802.11b (WiFi). More information can be found here: [www.sdcard.org/sdio](http://www.sdcard.org/sdio).

## CompactFlash

A CompactFlash extension socket for full I/O mode operation is provided by slot 0 of the PXA270 PC card controller, and supports type I,II CF+ cards. It appears in PC card memory space socket 0.

Address	Region name
0x20000000 – 0x23FFFFFF	Socket 0 I/O Space.
0x24000000 – 0x27FFFFFF	Reserved.
0x28000000 – 0x2BFFFFFF	Socket 0 Attribute Memory Space.
0x2C000000 – 0x2FFFFFFF	Socket 0 Common Memory Space.

This is a hot swappable 3.3V interface, controlled by the detection of a falling edge on GPIO35 of PXA270 when a CompactFlash card has been inserted (CF\_CD#). On detection, set GPIO97 (CF\_PWEN) to logic '1' to enable the 3.3V supply to the CompactFlash connector. The CompactFlash RDY/BSY# signal interrupts on PXA270's GPIO99.

Many CF+ cards require a reset once they have been inserted. To reset the CompactFlash socket independently set the CF\_RST bit to '1' in the REG2 register located at the address 0x13000000. To clear the CompactFlash reset write '0' to the CF\_RST bit.

### CF reset register [REG2]

Byte lane	Most significant byte								Least significant byte							
Bit	15	14	13	12	11	10	9	8	7	6	5	4	3	2	1	0
Field	-	-	-	-	-	-	-	-	-	-	-	-	-	-	-	CF_RST
Reset	X	X	X	X	X	X	X	X	X	X	X	X	X	X	X	0
R/W	-	-	-	-	-	-	-	-	-	-	-	-	-	-	-	R/W
Address	0x13000000															

CF+ is a small form factor card standard. It encompasses CompactFlash (CF) Flash data storage cards, magnetic disk cards and I/O cards including serial cards, Ethernet cards, fax/modem cards, digital phone cards, USB, barcode scanners, Bluetooth, IEEE802.11b (WiFi), wireless digital cell phone cards, and so on. For more details about CF+ standards and the availability of particular CF+ peripherals, see [www.compactflash.org](http://www.compactflash.org).

The CF+ card provides high capacity data storage and I/O functions that electrically comply with the Personal Computer Memory Card International Association (PCMCIA) standard.

For connection details for the standard 50 pin CompactFlash connector, see [J20 – CompactFlash connector](#), page 89.



## PC/104 interface

The ZEUS PC/104 interface is emulated from the PXA270 PC card interface to support 8/16 bit ISA bus style signals. As the interface is an emulation, the ZEUS does not support some PC/104 features. Please refer to the section [Unsupported PC/104 interface features](#) on page 43 for specific details.

Add-on boards can be stacked via the PC/104 interface to enhance the functionality of the ZEUS. Eurotech Ltd has an extensive range of PC/104 compliant modules and these can be used to quickly add digital I/O, analogue I/O, serial ports and motion control.

The ISA bus is based on the x86 architecture and is not normally associated with RISC processors. It is generally necessary to modify standard drivers to support any third party PC/104 modules.

Any PC/104 add-on board attached to the ZEUS is accessible from the PC card memory space socket 1. The memory map is shown in the following table:

Address	Region size	Region name
0x30000000 – 0x300003FF	1KByte	PC/104 I/O space, 8/16-bit.
0x30000400 – 0x3BFFFFFF	-	Reserved.
0x3C000000 – 0x3C1FFFFFF	16MB	PC/104 memory space, 16-bit (or 8-bit write only).

### *ZEUS PC/104 interface details*

The PC/104 bus signals are compatible with the ISA bus electrical timing definitions.

All signals between the PXA270 and the PC/104 are buffered. When the PC/104 bus is not in use, all output signals with the exception of the clock signals are set to their inactive state.

The ZEUS provides +5V to a PC/104 add-on board via the J12 and J13 connectors. If a PC/104 add-on board requires a +12V supply, then +12V must be supplied to the ZEUS power connector J2 pin 4. If –12V or –5V are required, these must be supplied directly to the PC/104 add-on board.

The reset signal applied to the PC/104 bus is combination of the RESET\_OUT# pin of PXA270 and an additional circuit that monitors +5V supply.

Due to the specific power management requirements of the PXA270, there is no reset generated to PXA270 if the +5V supply is below its limits. If the reset is generated to the PC/104 bus by the +5V monitoring IC, an interrupt can be asserted to PXA270 on GPIO20.

*PC/104 interrupts*

The PC/104 interrupts are combined together so that any interrupt generated on the PC/104 interface generates a single interrupt on the GPIO17 pin of the PXA270 processor.

Reading the PC104\_IRQ register located at the address 0x12800000 can identify the PC/104 interrupting source. The registers indicate the status of the interrupt lines at the time the register is read. The relevant interrupt has its corresponding bit set to '1'. The PXA270 is not designed to interface to 8-bit peripherals, so only the least significant byte from the word contains the data.

*PC/104 interrupt register [REG1]*

Byte lane	Most significant byte								Least significant byte							
Bit	15	14	13	12	11	10	9	8	7	6	5	4	3	2	1	0
Field	-	-	-	-	-	-	-	-	IRQ12	IRQ11	IRQ10	IRQ7	IRQ6	IRQ5	IRQ4	IRQ3
Reset	X	X	X	X	X	X	X	X	0	0	0	0	0	0	0	0
R/W	-	-	-	-	-	-	-	-	R/W							
Address	0x12800000															

Once the PXA270 microprocessor has serviced a PC/104 interrupt, the corresponding bit in the PC104\_IRQ register has to be cleared by writing a '1' to it. Clearing the corresponding bit in the PC104\_IRQ register will bring GPIO17 level to logic '0' and make the interrupt logic ready for the next PC104 interrupt. When one or more other PC104 IRQs are asserted while the driver is processing PC104 IRQ, the new PC/104 IRQ source has to wait for the current IRQ to be processed. This situation is shown in the following diagram:

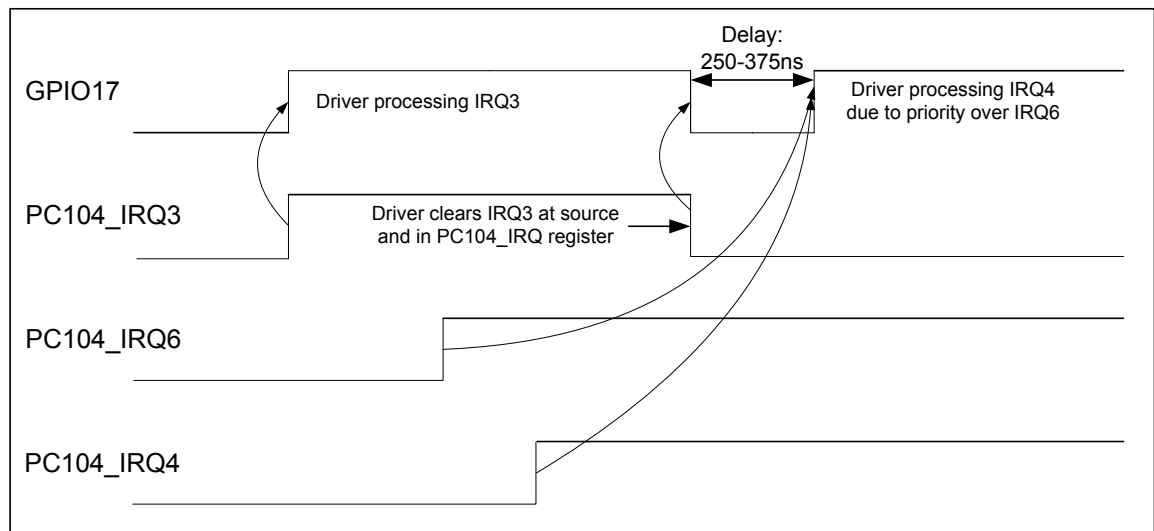

There is a delay of 250-375ns between the de-assertion of the GPIO17 IRQ signal and its new assertion due to the pending PC104 interrupt. This delay is introduced into the ZEUS hardware implementation to accommodate for the minimum inactive time of GPIO signals required by a PXA270 processor (154ns).



### *Unsupported PC/104 interface features*

The ZEUS does not support the following PC/104 bus features:

- PC/104 IRQ9, IRQ14 and IRQ15 are not available.
- DMA is not supported. Therefore, AEN signal is set to a constant logical zero.
- Bus mastering is not supported. Therefore, do not connect any other master add-on board to the ZEUS PC/104 interface.
- Shared interrupts are not supported. Do not connect more than one add-on board to the same interrupt signal line.
- BALE signal is set to a constant logical one as the address is valid over the entire bus cycle. Add-on PC/104 boards that implement transparent latch on address lines LA17-LA23 are compatible with the ZEUS implementation of BALE.
- The PXA270 PCMCIA memory controller does not support 8-bit memory read accesses for common memory space.
- The PXA270 PCMCIA memory controller does not support PC/104 MEMCS# signalling, so there is no support for dynamic bus sizing.

## Flat panel display

The PXA270 processor contains an integrated LCD display controller. It is capable of supporting both colour and monochrome single- and dual-scan display modules. It supports active (TFT) and passive (STN) LCD displays up to 800x600 pixels.

The PXA270 can drive displays with a resolution up to 800x600, but as the PXA270 has a unified memory structure, the bandwidth to the application decreases significantly. If the application makes significant use of memory, such as when video is on screen, you may also experience FIFO under-runs causing the frame rates to drop or display image disruption. Reducing the frame rate to the slowest speed possible gives the maximum bandwidth to the application. The display quality for an 800x600 resolution LCD is dependant on the compromises that can be made between the LCD refresh rate and the application. The PXA270 is **optimized** for a 640x480 display resolution.

A full explanation of the graphics controller operation can be found in the *Intel PXA27x Processor Family Developer's Manual* included on the Development Kit CD.

The [ZEUS-FPIF](#) interface board allows the user to easily wire-up a panel using pin and crimp style connectors (see page [122](#)). Contact [Eurotech Sales](#) (see page [97](#)) for purchasing information. Alternatively, the display interface is connected to an LVDS interface (see the section [LVDS interface](#), page [47](#)). This may be useful when driving displays located more than 300mm (12") from the ZEUS.

The following tables provide a cross-reference between the flat panel data signals and their function when configured for different displays.

### *TFT panel data bit mapping to the ZEUS*



The PXA270 can directly interface to 18-bit displays, but from a performance point of view it is better to use 16-bit only. 18-bit operation requires twice the bandwidth of 16-bit operation.

The following table shows TFT panel data bit mapping to the ZEUS:

Panel data bus bit	18-bit TFT	12-bit TFT	9-bit TFT
FPD 15	R5	R3	R2
FPD 14	R4	R2	R1
FPD 13	R3	R1	R0
FPD 12	R2	R0	-
FPD 11	R1	-	-
GND	R0	-	-
FPD 10	G5	G3	G2
FPD 9	G4	G2	G1
FPD 8	G3	G1	G0

*continued...*

Panel data bus bit	18-bit TFT	12-bit TFT	9-bit TFT
FPD 7	G2	G0	-
FPD 6	G1	-	-
FPD 5	G0	-	-
FPD 4	B5	B3	B2
FPD 3	B4	B2	B1
FPD 2	B3	B1	B0
FPD 1	B2	B0	-
FPD 0	B1	-	-
GND	B0	-	-

### STN panel data bit mapping to the ZEUS

Panel data bus bit	Dual scan colour STN	Single scan colour STN	Dual scan mono STN
FPD 15	DL7(G)	-	-
FPD 14	DL6(R)	-	-
FPD 13	DL5(B)	-	-
FPD 12	DL4(G)	-	-
FPD 11	DL3(R)	-	-
FPD 10	DL2(B)	-	-
FPD 9	DL1(G)	-	-
FPD 8	DL0(R)	-	-
FPD 7	DU7(G)	D7(G)	DL3
FPD 6	DU6(R)	D6(R)	DL2
FPD 5	DU5(B)	D5(B)	DL1
FPD 4	DU4(G)	D4(G)	DL0
FPD 3	DU3(R)	D3(R)	DU3
FPD 2	DU2(B)	D2(B)	DU2
FPD 1	DU1(G)	D1(G)	DU1
FPD 0	DU0(R)	D0(R)	DU0

The table below explains the clock signals required for passive and active type displays:

ZEUS	Active display signal (TFT)	Passive display signal (STN)
PCLK	Clock	Pixel Clock
LCLK	Horizontal Sync	Line Clock
FCLK	Vertical Sync	Frame Clock
BIAS	DE (Data Enable)	Bias

### *LCD logic and backlight power*

The display signals are +3.3V compatible. The ZEUS contains power control circuitry for the flat panel logic supply and backlight supply. The flat panel logic is supplied with a switched 3.3V (default) or 5V supply (for details see the section [JP3 – LCD logic supply selection](#), page 94). The backlight is supplied with a switched 5V supply for the inverter.

The power switches (TPS2033D) for flat panel logic and backlight have the current-limiting (1.5A) and thermal protection features which eliminates the need for the fuses.

The PXA270 GPIO101 pin (LCDEN signal) controls the supply voltage to the LCD display.

LCDEN (CPU_GPIO101)	Selected LCD function
0	LCD power off (default)
1	LCD power On

The PXA270 GPIO19 pin (BKLEN signal) controls the supply voltage to the backlight inverter:

BKLEN (CPU_GPIO19)	Selected backlight function
0	BKLSAFE Power Off (Default)
1	BKLSAFE 5V Power On

The BKLEN signal is also routed to the connector J14. See the section [J14 – LCD connector](#), page 85, for J14 pin assignment and connector details.

Signals BKLEN and BKLSAFE are also routed to the connector J24. See the section [J24 – Backlight power](#), page 92, for further details.

Typically the power up sequence is as follows (please check the datasheet for the particular panel in use):

- 1 Enable display power.
- 2 Enable flat panel interface.
- 3 Enable backlight.

Power down is in reverse order.

### LCD backlight brightness control

GPIO16 of the PXA270 processor is used for backlight brightness control (signal PWM0 on the J14 connector). The control of the backlight brightness is dependent upon the type of backlight inverter used with the display. Some inverters have a 'DIM' function, which uses a logic level to choose between two levels of intensity. If this is the case then GPIO16 (Alternative Function 0) is used to set this. Other inverters have an input suitable for a pulse-width modulated signal or analogue voltage control. In this case GPIO16 should be configured as PWM0 (Alternative Function 2).

Signal PWM0 is also routed through a low-pass filter on the ZEUS to enable analogue voltage control of backlight brightness (signal BRT\_CTRL on connector [J24 – Backlight power](#) - see page [92](#)). The voltage range of BRT\_CTRL is 0-2.5V.

### STN bias voltage

The ZEUS provides a negative and a positive bias voltage for STN type displays (turned on by the PXA270 GPIO101 pin). The negative and positive bias voltages are factory set to -22V and +22V respectively. Pin connections for these can be found in the section [J14 – LCD connector](#), page [85](#). Please contact [Eurotech Technical Support](#) (see page [97](#)) for details of other bias voltages.



Do not exceed 20mA load current.

---

### LVDS interface

There is an optional Low-Voltage Differential Signalling (LVDS) interface available on the ZEUS. LVDS combines high data rates with low power consumption. The benefits of LVDS include low-voltage power supply compatibility, low noise generation, high noise rejection and robust transmission signals.

The National Semiconductor transmitter DS90C363 is used to convert 16-bits of LCD data signals into three LVDS data streams. A phase-locked transmit clock is transmitted in parallel with the data streams over a fourth LVDS link. The LVDS signals are routed to the connector J16. For the connector details see the section [J16 – LVDS connector](#), page [86](#).

The LVDS transmitter is enabled using the signal LVDS\_EN (GPIO21 on PXA270). Details are shown in the following table:

LVDS_EN (CPU_GPIO 21)	Selected LVDS function
0	LVDS power down (default)
1	LVDS enable

The LVDS transmitter can be programmed for rising edge strobe or falling edge strobe operation through a signal LVDS\_FES# (Expander 2 – GPIO1, I2C address 0x22). Details are shown in the following table:

LVDS_FES# (EXP2_GPIO1)	Selected LVDS function
0	Falling edge strobe
1	Rising edge strobe (default)

Connector J24 should be used to supply the power and brightness control for the backlight inverter when the LVDS interface is used. See the section [J24 – Backlight power](#), page [92](#), for details.

## Audio

A Wolfson WM9712L AC'97 audio CODEC is used to support the audio features of the ZEUS. Audio inputs supported by the WM9712L are stereo line in and a mono microphone input.

The WM9712L provides a stereo line out that is amplified by a National Semiconductor LM4880 250mW per channel power amplifier, suitable for driving an 8Ω load. The WM9712L AC'97 codec may be turned off if it is not required. See the section [Audio power management](#), page 71, for details.

Connection to the ZEUS audio features is via header J4.

See the section [J4 – Audio connector](#), page 79, for connector and mating connector details. The table below shows pin assignments:

Function	Pin	Signal	Signal levels (max)	Frequency response (Hz)
Microphone	10	MIC input		
	9	MIC voltage reference	1Vrms	20 – 20k
	7	MIC output Audio ground reference.		
Line in	1	Line input left	1Vrms	20 – 20k
	5	Line input right		
	3	Audio ground reference		
Line out	2	Line output left	1Vrms	20 – 20k
	6	Line output right		
	4	Audio ground reference		
Amp out	8	Amp output left	1.79V peak	20 – 20k
	11	Amp output right	1.26Vrms	
	12	Audio ground reference	(8Ω load) 223mW	

## Touchscreen controller

The ZEUS supports 4-wire and 5-wire analogue resistive touchscreens using the controller available within the Wolfson WM9712L audio CODEC. The touchscreen controller supports the following functions:

- X co-ordinate measurement.
- Y co-ordinate measurement.
- Pen down detection with programmable sensitivity.
- Touch pressure measurement (4-wire touchscreen only).

The touchscreen can be used as a wake-up source for PXA270 from sleep mode.

The touchscreen interface is broken out on the header J1. For details see [J1 – Touchscreen connector](#), page [77](#).



## USB

There are two USB host interfaces on the ZEUS. These comply with the Universal Serial Bus Specification Rev. 1.1, supporting data transfer at full-speed (12Mbit/s) and low-speed (1.5Mbit/s).

There are four signal lines associated with each USB channel: VBUS, DATA+, DATA-, GND. The USB host ports are connected to a dual USB connector, type A (J8).

A USB power control switch controls the power and protects against short-circuit conditions. If the USB voltage is short-circuited, or more than 500mA is drawn from either supply, the switch turns the power supply off and automatically protects the device and board. The VBUS power supply is derived from the ZEUS +5V supply. To switch the VBUS1 and VBUS2 power on, use the PXA270 GPIO89 and GPIO22 respectively (set them to logic '1').

USB port 2 can be configured as a client port internally within the PXA270 USB controller, and is connected to 5-pin header J10.

For details of connector pinouts, see the sections [J8 – USB connector](#), page [81](#), and [J10 – USB client header](#), page [82](#).

More information about the USB bus and the availability of particular USB peripherals can be found at [www.usb.org](http://www.usb.org).



Host port 2 on J8 and client port on J10 can only be used one at a time.  
DO NOT connect both devices at the same time.

---

## Ethernet

The ZEUS SBC provides two 10/100-BaseTX interfaces with MAC and complies with both the IEEE802.3u 10/100-BaseTX and the IEEE 802.3x full-duplex flow control specifications.

Two single 10/100-BaseTX Ethernet controllers, Davicom DM9000A, are used to implement Ethernet interfaces on ZEUS. DM9000A device provides an embedded PHY and MAC and connects to 10/100-BaseTX magnetics. DM9000A also supports AUTO-MDIX feature. Configuration data and MAC information are stored in an external serial EEPROM (93LC46).

The DM9000A devices are connected to the PXA270 data bus (16-bit), and are memory mapped. Connection to the ZEUS Ethernet ports is via dual RJ45 connector, J6, with speed and link/activity status LEDs. For pin assignment and connector details, see [J6 – Ethernet connector](#), page [80](#).

The link/activity LED (yellow) is illuminated when a 10/100-BaseTX link is made, and when there is Tx/Rx activity. The speed LED (green) is illuminated when 100MB/s speed is selected.

## Serial COM ports

There are seven serial communications ports available on the ZEUS. Three are provided by the PXA270 and are used for the optional wireless modem, GPS and IEEE802.15.4 / ZigBee ports.

There are four additional high-speed, 16550 compatible serial UARTs implemented by an EXAR ST16C554Q Quad UART device. Two of these channels (COM1, COM2) can be used as standard RS232 serial interfaces, COM3 can be configured as RS232 or RS485/422, and COM4 can be configured as RS422 or RS485. The table below provides a summary of the four additional serial ports.

Port	Address	IRQ	FIFO depth RX / TX	Signals
COM1	0x10000000 – 0x1000000F	GPIO9	16/16	RS232: Rx, Tx, CTS, RTS, RI, DSR, DCD, DTR
COM2	0x10800000 – 0x1080000F	GPIO10	16/16	RS232: Rx, Tx, CTS, RTS, RI, DSR, DCD, DTR
COM3	0x11000000 – 0x1100000F	GPIO12	16/16	RS232: Rx, Tx, CTS, RTS, RI, DSR, DCD, DTR or RS422/485: Rx, Tx
COM4	0x11800010 – 0x1180001F	GPIO11	16/16	RS422/RS485: Rx, Tx

### COM1/2 – RS232 interface

Supported on Channel A and B of the external Quad UART, the ports are buffered to RS232 levels with  $\pm 15\text{kV}$  ESD protection, and support full handshaking and modem control signals. The maximum baud rate is 921.6 Kbaud. COM1 and COM2 ports can be accessed using DB9 connectors J11 and J15, respectively. For pin assignment and connector details, see [J11 – Serial port – COM1](#) on page [83](#) and [J15 – Serial port – COM2](#) on page [86](#).

A factory fit option configures COM1 as TTL Level signals to interface to certain specialized modems. Please contact [Eurotech Technical Support](#) (see page [97](#)) for details.

*COM3 – RS232/RS485/RS422 interface*

Supported on Channel C of the external Quad UART, COM3 port can be configured by software as RS232 or RS485/RS422.

The port is buffered to RS232 (or RS485/RS422) levels with  $\pm 15\text{kV}$  ESD protection. RS232 interface supports full handshaking and modem control signals. The maximum baud rate on this channel is 921.6 Kbaud. COM3 RS232 interface is connected to the connector J19, and RS485/422 interface is connected to the connector J18. For pin assignment and connector details, see [J18 – Serial port \(RS485/422\) – COM3](#) on page 87 and [J19 – Serial ports – COM3/4](#) on page 88.

Three control outputs of I<sup>2</sup>C GPIO expander (I<sup>2</sup>C address 0x21) are used to select one of the operating modes RS232, RS485 or RS422. The selection is implemented by using two control signals (U3\_RS232EN, U3\_RS422EN) to enable/disable the associated transceivers. The control signal combinations are shown in the following table:

U3_RS232EN (EXP1_GPIO 0)	U3_RS422EN (EXP1_GPIO 1)	Selected COM3 function
1	X	RS232
0	0	RS485 Full duplex
0	1	RS422 Half duplex



U3\_RS232EN and U3\_RS422EN are at logic '1' upon reset.

The control signal U3\_TERM# is used to enable/disable the RS485/422 line termination and must be enabled if the ZEUS board is at the end of the network. The following table shows the usage of U3\_TERM# signal:

U3_TERM# (EXP1_GPIO 2)	Termination resistors (120 $\Omega$ )
0	Connected
1	Disconnected



U3\_TERM# is at logic '1' upon reset.

The RS485/422 driver (LTC2859) on ZEUS features a logic-selectable reduced slew mode that softens the driver output edges to control the high frequency EMI emissions from equipment and data cables. The reduced slew rate mode is entered by taking the SLO# pin low, where the data rate is limited to about 250kbps. Slew limiting also mitigates the adverse effects of imperfect transmission line termination caused by stubs or mismatched cables.

U3_RS485_SLO# (EXP2_GPIO 5)	Slew rate
0	Reduced
1	Normal

*COM4 – RS422/485 interface*

Supported on Channel D of the external Quad UART, and buffered to RS422/485 levels with  $\pm 15\text{kV}$  ESD protection, this channel provides support for RS422 or RS485 (software selectable) interfaces. The maximum baud rate on this channel is 921.6 Kbaud. COM4 port is connected to the connector J19.

The GPIO15 pin of the I<sup>2</sup>C GPIO expander (I<sup>2</sup>C address 0x21) is used to select RS422 or RS485 interface mode as shown in the following table:

U4_RS485EN (EXP1_GPIO 15)	Selected COM4 function
0	RS422 Full duplex
1	RS485 Half duplex



U4\_RS485EN is at logic '1' upon reset.

The GPIO16 pin of the I<sup>2</sup>C GPIO expander (I<sup>2</sup>C address 0x21) is used to enable/disable the RS485/422 line termination and must be enabled if the ZEUS board is at the end of the network. The following table shows the usage of U4\_TERM# signal:

U4_TERM# (EXP1_GPIO 16)	Termination resistors (120 $\Omega$ )
0	Connected
1	Disconnected



U4\_TERM# is at logic '1' upon reset.

The RS485/422 driver (LTC2859) on ZEUS features a logic-selectable reduced slew mode that softens the driver output edges to control the high frequency EMI emissions from equipment and data cables. The reduced slew rate mode is entered by taking the SLO# pin low, where the data rate is limited to about 250kbps. Slew limiting also mitigates the adverse effects of imperfect transmission line termination caused by stubs or mismatched cables.

U4_RS485_SLO# (EXP2_GPIO 6)	Slew rate
0	Reduced
1	Normal

Further details about the RS422 and RS485 interfaces are provided below.

*RS422*

The RS422 interface provides full-duplex communication. The signals available are TX+, TX-, RX+, RX- and ground. The maximum cable length for an RS422 system is 1200m (4000ft). It supports one transmitter and up to ten receivers.

RS485

This is a half-duplex interface that provides combined TX and RX signals (TX+/RX+ and TX-/RX-). A ground connection is also required for this interface. The maximum cable length for this interface is the same as RS422 - 1200m (4000ft), but RS485 supports up to 32 transmitters and receivers on a single network. Only one transmitter should be switched on at a time. The ZEUS uses the RTS# signal to control transmission. When this signal is at logic 1, the driver is switched off and data can be received from other devices. When the RTS# line is at logic 0, the driver is on. Any data transmitted from the ZEUS is automatically echoed back to the receiver. This enables the serial communications software to recognize that all data has been sent, and disable the transmitter when required.

Typical RS422 and RS485 connection

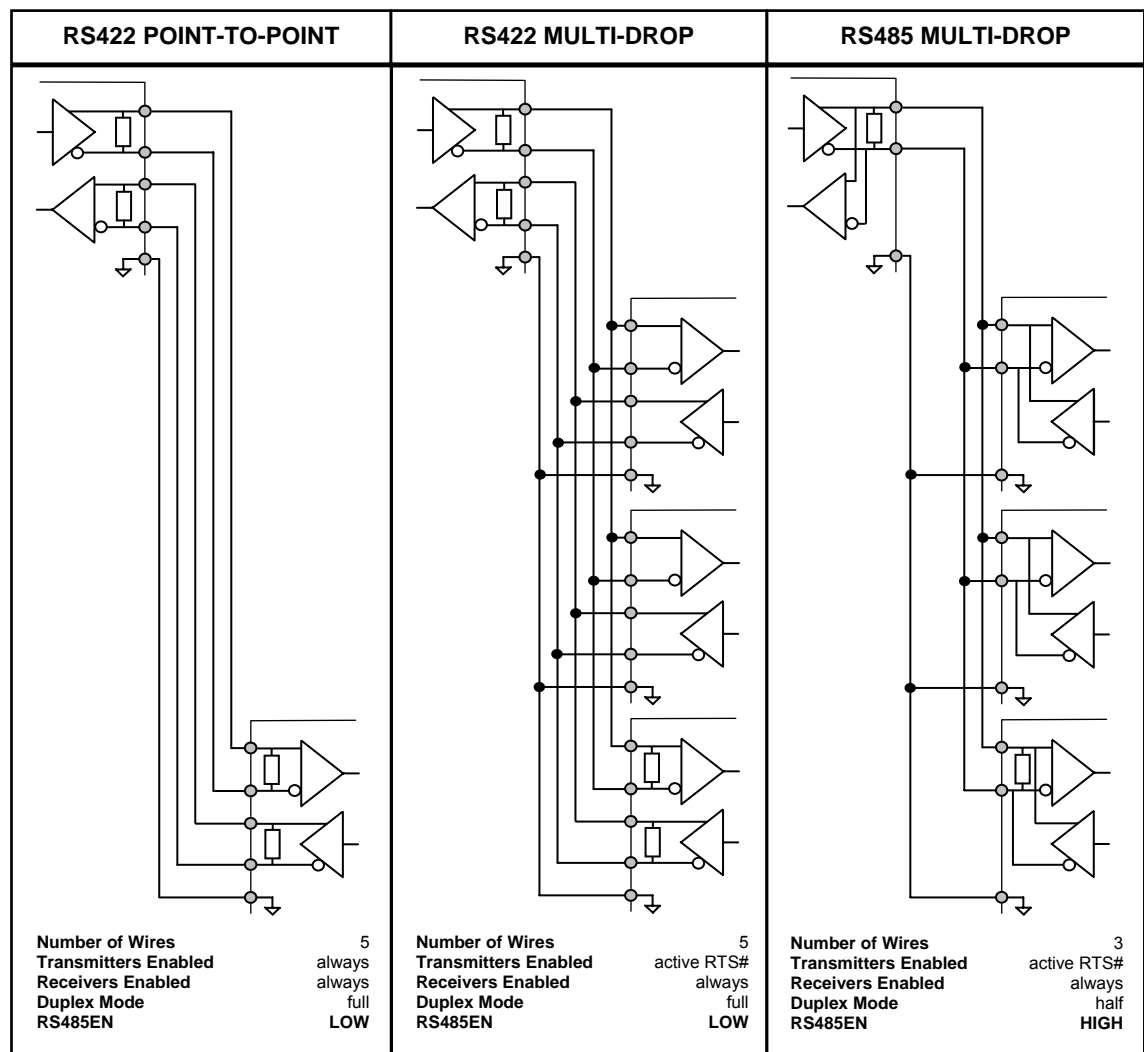

Only set U3\_TERM# (U4\_TERM#) at logic low if the ZEUS is at the end of the network.

## CAN bus

A Microchip MCP2515 CAN 2.0B protocol compatible controller and MCP2551 transceiver are used on the ZEUS to provide Controller Area Network (CAN) bus connectivity. CAN is a high-integrity serial data communications bus for real-time applications. It operates at data rates of up to 1 Mbit/s and has excellent error detection capabilities. A 16MHz clock is supplied to the CAN controller.

The MCP2515 controller connects to the SPI serial interface of the PXA270 processor. A MCP2551 transceiver is opto-isolated from the rest of the circuit (3.75kV isolation voltage), but an external isolated 5V supply needs to be provided to supply the transceiver and the opto-isolators. Alternatively, non-isolated operation is available through a factory fit option. Contact [Eurotech Technical Support](#) (see page [97](#)) for details.

The CAN bus interface is broken out to the header J17. For connector details see the section [J17 – CAN bus](#), page [87](#).

Jumpers JP5, JP6 can be used to connect 62Ω termination resistors when the ZEUS is at the end of the network. Split termination concept is used on ZEUS (see figure below). For details see the section [JP5 & JP6 – CAN bus termination](#), page [95](#).

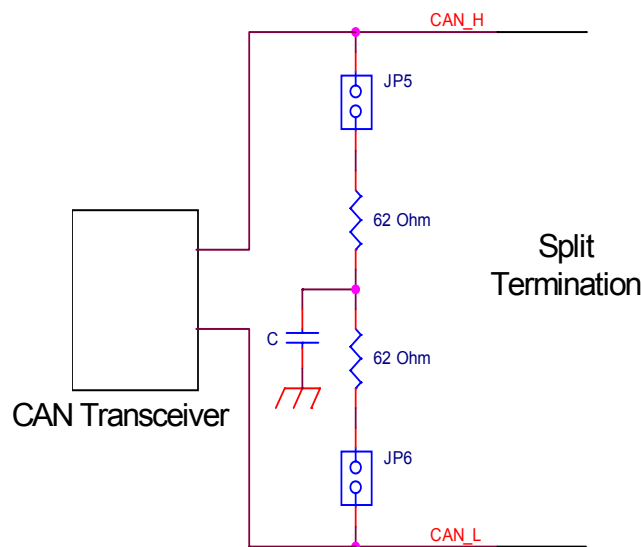

## I<sup>2</sup>C bus

The PXA270 I<sup>2</sup>C interface is brought out to the COMs connector J19. See the section [J19 – Serial ports – COM3/4](#), page [88](#), for connection details.

I<sup>2</sup>C bus is also used with the Quick Capture interface. See the section [Quick Capture camera interface](#), page [59](#).

The following table lists the on-board I<sup>2</sup>C devices:

Device name	I <sup>2</sup> C address
External General Purpose I/O	0x20
On-board GPIO Expander 1	0x21
On-board GPIO Expander 2	0x22
Temperature Sensor (LM75A)	0x48
RTC (Intersil ISL1208)	0x6F
Config EPROM	0x50-0x57

The I<sup>2</sup>C unit supports a fast mode operation of 400KB/s and a standard mode of 100KB/s.

Fast-mode devices are downward compatible and can communicate with standard-mode devices in a 0 to 100KB/s I<sup>2</sup>C bus system. As standard-mode devices, however, are not upward compatible, they should not be incorporated in a fast-mode I<sup>2</sup>C bus system as they cannot follow the higher transfer rate and unpredictable states would occur.



The I<sup>2</sup>C interface does not support the hardware general call, 10-bit addressing, high-speed mode (3.4Mbit/s) or CBUS compatibility.

You should keep the total bus load below 200pF.

---



## Quick Capture camera interface

The Quick Capture camera interface is a component of Intel Quick Capture technology which provides a connection between the PXA270 processor and a camera image sensor. The Quick Capture interface is designed to work primarily with CMOS-type image sensors and supports up to 4 Megapixel resolution. However, it may be possible to connect some CCD-type image sensors to the PXA27x processor (PXA27x processor), depending on a specific CCD sensor's interface requirements.

The Quick Capture interface acquires data and control signals from the image sensor, and performs the appropriate data formatting prior to routing the data to memory, using direct memory access (DMA). A broad range of interface and signalling options provides direct connection. The image sensor can provide raw data through a variety of parallel and serial formats. For sensors that provide pre-processing capabilities, the Quick Capture interface supports several formats for RGB and YCbCr colour space.

The Quick Capture interface signals are connected to the header J9. The I<sup>2</sup>C interface is available on the same header since most of the camera image sensors require an I<sup>2</sup>C control interface. For I<sup>2</sup>C bus address map on the ZEUS, see the section [I<sup>2</sup>C bus](#) on the previous page. For connector details, see the section [J9 – Camera interface connector](#), page [82](#).

## External General purpose I/O

A Maxim MAX7313 I<sup>2</sup>C I/O Expander provides sixteen general purpose input/output lines on the header J7. Each I/O port can be individually configured as either an open-drain current-sinking output rated at 50mA with 10K pull-up to 5V, or a logic input with transition detection. The I/O Expander inputs are 5V tolerant.

The I/O Expander is addressable at I<sup>2</sup>C serial bus address 0x20 and is accessed in fast-mode operation at 400 kbps. On power-up all control registers are reset and the MAX7313 enters standby mode. Power-up status makes all ports into inputs, so the state of all 17 ports (P0-P16) is logic high (through 10K pull-up to 5V).

See the section [J7 – GPIO connector](#), page 81, for connector pinout and mating connector details. The signals on J7 correspond to the pin names of the MAX7313 (P0-P15).

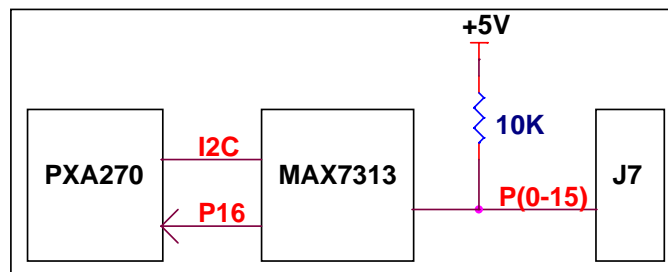

Port 16 of the MAX7313 is configured as an interrupt, so that any I/O Expander GPIO pin configured as an input can cause the PXA270 to be interrupted on GPIO1. These can also be used as PXA270 wake-up sources from sleep mode.

## Temperature sensor

There is a Philips LM75A temperature sensor on the ZEUS. The LM75A is a temperature-to-digital converter using an on-chip band-gap temperature sensor and sigma-delta A-to-D conversion technique. The device is also a thermal detector providing an over-temperature detection output (OVERTEMP signal on GPIO96 of PXA270). The accuracy of LM75A is  $\pm 2$  °C (at -25 °C to 100 °C), and  $\pm 3$  °C (at -55 °C to 125 °C). LM75A is connected to the I<sup>2</sup>C bus of PXA270 processor, and is accessible at I<sup>2</sup>C bus address 0x48.

## JTAG and debug access

Debug access to the PXA270 processor is via the JTAG connector J5. A standard ARM 20-pin header is used for the JTAG interface. See [J5 – JTAG connector](#), page [79](#), for details.

Jumper JP7 needs to be inserted to enable the JTAG interface for PXA270 debug. See section [JP7 - JTAG Enable](#), page [95](#) for details.

The Macraigor Wiggler (see [www.macraigor.com/wiggler.htm](http://www.macraigor.com/wiggler.htm)) and usb2Sprite (see [www.macraigor.com/usb2sprite.htm](http://www.macraigor.com/usb2sprite.htm)) probes have been used to debug the PXA270 processor on the ZEUS. There are many other debug tools that can be interfaced to the ZEUS for access to the JTAG Interface of the PXA270 processor.



In addition to the PXA270, there are two CPLDs (XC9536XL-CS48 and XC9572XL-CS48) in the JTAG chain on the ZEUS. The BSDL files can be found on the [www.xilinx.com](http://www.xilinx.com) web site.

---

# Power and power management

## Power supplies

The ZEUS is designed to operate from a single +5V±5% (4.75V to +5.25V) input or the onboard 10V to 30V DC/DC PSU.

### *DC input voltage (10-30V)*

DC input voltage (10-30V) is connected through a front panel locking DC jack J3 (see the section [J3 – Power connector \(10-30V\)](#), page 78). When operating from the 10 to 30V input, the 5V connector (J2) is **NOT** fitted. The input rails are protected from overcurrent, overvoltage, undervoltage and reverse battery conditions, and include transient suppression to achieve compatibility with vehicle power supplies. The on-board DC/DC converter can provide a maximum current of 5A at 5V at a temperature range of 0-70°C (32-158°F).

For vehicle-based applications, the supervisory circuit monitors the auxiliary ignition supply input (Vig), and provides feedback of ignition status to the PXA270 (IG\_FAIL signal at GPIO115). If the Vig falls below 9.2V, IG\_FAIL becomes logic '1'. This can be used to instigate an orderly shutdown or to store ignition status data.

### *5V only operation*

For 5V only operation, the ATX style connector J2 is used as the main power input for the ZEUS. In this case, connector J3 and the entire DC/DC PSU circuit is depopulated. The power connector J2 has a +12V connection too, but it is not required for the ZEUS under normal operation. It can be used to supply +12V to the PC/104 stack if required. For details of the 5V power connector see the section [J2 – Power connector \(5V option\)](#), page 78. Contact [Eurotech Sales](#) (see page 97) for details.



If a CompactFlash and an LCD display are used, ensure the total current requirement on the 3.3V rail does not exceed 900mA. Please check the datasheets of the devices you are using.

---

### On-board supplies

There are seven on-board supply voltages derived from the +5V supply. They are listed in the following table:

Supply rail	Power domains	Voltage	Reset threshold
VCC_BATT	PXA270 Sleep-control subsystem, oscillators and real time clock	3.3V or 3.0V	2.25V
VCC_CORE	PXA270 core and other internal units	0.85V-1.55V	91% of nominal
VCC_PLL	PXA270 Phase-locked loops	1.3V	1.18V
VCC_SRAM	PXA270 Internal SRAM units	1.1V	1V
+3V3	PXA270 I/O, PXA270 internal units, on-board 3.3V peripherals	3.3V	3.05V
VCC_PER	PC/104, Audio Amp, CAN Bus transceiver, External GPIO pull-ups	5V	4.63V (PC/104 only)
VCC_MODEM	Zeus Modem	5V	NA

Reset will be generated if the supplies fall below the thresholds shown in the table.

VCC\_CORE, VCC\_PLL and VCC\_SRAM rails are controlled by PWR\_EN signal of the PXA270. They are switched off when PXA270 is in sleep or deep-sleep mode.

VCC\_PER, VCC\_MODEM and +3V3 supply rails are controlled by SYS\_EN signal of the PXA270. They are switched off when PXA270 is in deep-sleep mode.

VCC\_PER rail is also monitored, and reset will be generated to the PC/104 interface if the voltage falls below 4.63V. This can also generate an interrupt on pin GPIO20 of the PXA270.

### Power management IC

The Linear Technology device LTC3445 is used to provide the power supply for the PXA270. It is specifically designed for the PXA27x family of microprocessors.

The LTC3445 contains a high efficiency buck regulator (VCC\_CORE), two LDO regulators (VCC\_PLL, VCC\_SRAM), a PowerPath controller and an I<sup>2</sup>C interface. The buck regulator has a 6-bit programmable output range of 0.85V to 1.55V. The buck regulator uses either a constant frequency of 1.5MHz, or a spread spectrum switching frequency. Using the spread spectrum option gives a lower noise regulated output, as well as low noise at the input. In addition, the regulated output voltage slew rate is programmable via the Power Management I<sup>2</sup>C interface of the PXA270.

### Battery backup

An on-board non-rechargeable coin cell battery (CR2032) provides a 3V battery backup supply for the ISL1208 RTC, external SRAM and the supply supervisor, when there is no +5V supply to the board. The ZEUS is normally shipped with battery disconnected. See [JP2 – Battery disconnect](#), page 93, for details.

The table below shows the typical and maximum current load on the backup battery:

Device load on battery	Typical ( $\mu\text{A}$ )	Maximum ( $\mu\text{A}$ )
SRAM	0.3	3
ISL1208 RTC (with Clock Out Off)	0.4	0.95
Supply Supervisor	0.5	0.5
Total	1.2	1.45



An onboard Schottky diode drops 13mV from VBAT at +25°C (+77°F). At -40°C (-40°F) this may increase to 170mV and at +85°C (+185°F) it may decrease below 10mV. The SRAM and ISL1208 minimum voltages are 1.5V and 1.8V respectively. Reliable operation below these minimum voltages cannot be guaranteed.

## Processor power management

First available in the PXA270 processor, Wireless Intel SpeedStep Technology dynamically adjusts the power and performance of the processor based on CPU demand. This can result in a significant decrease in power consumption.

In addition to the capabilities of Intel Dynamic Voltage Management, the Intel XScale micro architecture of the PXA27x family incorporates three new low power states. These are deep idle, standby and deep sleep. It is possible to change both voltage and frequency on the fly by intelligently switching the processor into the various low power modes. This saves additional power while still providing the necessary performance to run rich applications.

Wireless Intel SpeedStep technology includes the following features:

- Five reset sources: power-on, hardware, watchdog, GPIO and exit from sleep and deep-sleep modes (sleep-exit).
- Multiple clock-speed controls to adjust frequency, including frequency change, turbo mode, half-turbo mode, fast-bus mode, memory clock, 13M mode, A-bit mode and AC '97.
- Switchable clock source.
- Functional-unit clock gating.
- Programmable frequency-change capability.
- One normal-operation power mode (run mode) and five low power modes to control power consumption (idle, deep-idle, standby, sleep and deep-sleep modes).
- Programmable I<sup>2</sup>C-based external regulator interface to support changing dynamic core voltage, frequency change and power mode coupling.

The PXA270 power consumption depends on the operating voltage and frequency, peripherals enabled, external switching activity, external loading and other factors. The tables below contain power consumption information at room temperature for several operating modes: active, idle and low power. For active power consumption data, no PXA270 peripherals are enabled except for on-chip UARTs.



Frequency	System bus frequency	Active power consumption typ.	Idle power consumption typ.	Conditions
520MHz	208MHz	747 mW	222 mW	VCC_SRAM = 1.1V; VCC_PLL = 1.3V; VCC_MEM, VCC_BB, VCC_USIM, VCC_LCD = 1.8V; VCC_IO, VCC_BATT, VCC_USB=3.0V
416MHz	208MHz	570 mW	186 mW	VCC_CORE = 1.35V
312MHz	208MHz	390 mW	154 mW	VCC_CORE = 1.25V
312MHz	104MHz	375 mW	109 mW	VCC_CORE = 1.1V
208MHz	208MHz	279 mW	129 mW	VCC_CORE = 1.15V
104MHz	104MHz	116 mW	64 mW	VCC_CORE = 0.9V
13MHz	CCCR[CPDIS]=1	44.2 mW	-	VCC_CORE = 0.85V

PXA270 low power modes	Power consumption typ.	Conditions
13MHz idle mode (LCD on)	15.4mW	VCC_MEM, VCC_BB, VCC_USIM, VCC_LCD = 1.8V VCC_IO, VCC_BATT, VCC_USB= 3.0V
13MHz idle mode (LCD off)	8.5mW	VCC_CORE, VCC_SRAM, VCC_PLL = 0.85V
Deep sleep mode	0.1mW	VCC_CORE, VCC_SRAM, VCC_PLL = 0V
Sleep mode	0.16mW	VCC_CORE, VCC_SRAM, VCC_PLL = 0V
Standby mode	1.7mW	VCC_CORE, VCC_SRAM, VCC_PLL = 3.0V

### Wake-up sources

The PXA270 offers two sleep modes:

- *Sleep mode* offers lower power consumption by switching off most internal units. There is no activity inside the processor, except for the units programmed to retain their state in the PSLR register, the real time clock and the clocks and power manager. Because internal activity has stopped, recovery from sleep mode must occur through an external or internal real time clock event. External wake-up sources are GPIO<n> edge detects (they are listed in the section [PXA270 GPIO pin assignments](#), page [22](#)).
- *Deep-sleep mode* offers the lowest power consumption by powering most units off. There is no activity inside the processor, except for the real time clock (RTC) and the clocks and power manager. Because internal activity has stopped, recovery from deep-sleep mode must be through an external event or an RTC event. In deep-sleep mode, all the PXA270 power supplies (VCC\_CORE, VCC\_SRAM, VCC\_PLL, VCC\_IO excluding VCC\_BATT) are powered off for minimized power consumption. On the ZEUS, the main +3.3V rail supplies the VCC\_IO power domain of the PXA270. Since the +3.3V supply is switched off in deep-sleep mode, all the on-board peripherals are powered off and it is not possible to use external wake-up sources. In this situation, recovery from deep-sleep mode must be through an internal RTC event.

For more information on PXA270 power management, see section 3.6 in the *Intel PXA27x Processor Family Developer's Manual*, included on the Development Kit CD.

## Peripheral devices power management

The following table gives the estimated power consumption of on-board peripherals:

On-board peripheral	Maximum power consumption	Low power mode	
		Minimum consumption	Operating mode
Quad UART	66mW (20mA@3.3V)	10mW (3mA@3.3V)	Idle
Ethernet 2x DM9000A	607mW (2x92mA@3.3V)	46mW (2x7mA@3.3V)	Power-down
CAN MCP2515	50mW (10mA@5V)	0.025mW (5uA@5V)	Sleep
CAN transceiver	375mW (75mA@5V)	1.8mW (200uA@5V)	Standby
AC'97 Codec WM9712L	80mW	0.001mW	OFF
Boomer Amp LM4880	30mW (6mA@5V)	0.025mW (5uA@5V)	Shut-down
SDRAM x4	2640mW (4x200mA@3.3V)	26.4mW (4x2mA@3.3V)	Power-down
Flash	165mW (50mA@3.3V)	0.015mW (5uA@3.3V)	Standby
SRAM	72mW (22mA@3.3V)	0.001mW (3uA@3.3V)	Standby
RS485	6.6mW (2mA@3.3V)	5mW (1.5mA@3.3V)	Disable
CPLD x2	66mW (2x10mA@3.3V)	20mW (2x3mA@3.3V)	Idle
LVDS transceiver	165mW (50mA@3.3V)	0.17mW (55uA@3V)	Power-down
I/O expander x2	1.6mW (2x120uA@3.3V)	0.02mW (2x3uA@3.3V)	Idle
RTC	0.4mW (120uA@3.3V)	0.012mW (4uA@3.3V)	Idle
Temperature sensor	3.3mW (1mA@3.3V)	0.010mW (3.5uA@3.3V)	Shut-down
Config PROM	3.3mW (1mA@3.3V)	0.003mW (1uA@3.3V)	Standby
<b>Total</b>	<b>4.5W</b>	<b>102mW</b>	

External peripheral devices include CF+ card (1.5W max), two USB devices (5W max), add-on PC/104 cards (5W max), wireless modem (8.5W peak), LCD and Inverter (4W max), GPS module (50mW max), ZigBee module (30mW max), SDIO (350mW max) and Quick Capture camera (50mW max).

The table below gives examples of power drawn by specific external peripheral devices:

Device	Part number	Condition	Power (mW)
64MB Sandisk CompactFlash	SDCFJ-64	Sleep	1
		Writing consistently	220
Socket WiFi 802.11b SDIO	WL6200-480	Idle (listening)	50
		Transmitting	925
64MB FlashDio USB memory stick	FDU100A	Inserted (no access)	375
		Reading consistently	605
NEC 5.5" LCD + Inverter	NL3224BC35-20 + 55PW131	LCD and backlight on	3250
		LCD on and backlight off	825
GSM/GPRS module	Siemens MC39i	Data mode GPRS 900	2100
		Power down mode	0.18
GPS module	Fastrax iTRAX03/08	Continuous mode	100
		Sleep mode	0.06
ZigBee module	Eurotech ZM1	Rx	25
		Power down	0.1
VGA CMOS sensor module	Dialog DA3520	Active	50



When PXA270 is placed in deep-sleep mode, the power to all the peripherals (on-board and external) is switched off by SYS\_EN signal of the PXA270.

### CompactFlash power management

The power supply to the CompactFlash interface is controlled via software, and supports hot swap card insertion and CompactFlash power down states. GPIO97 on the PXA270 (signal CF\_PWEN) is used to control the power supply switch. Setting this line to logic '0' switches off the power to the CompactFlash interface. The current-limiting (1A) and thermal protection features of the power switch eliminate the need for the fuse. The power supply to the CompactFlash is derived from 3.3V supply.

CPU_ GPIO97 (CF_PWEN)	CF power
0	Power off
1	Power on

### Wireless modem power management

The power supply to the wireless modem interface (VCC\_MODEM) is controlled by SYS\_EN signal of the PXA270, and is switched off when PXA270 is in deep-sleep mode. The current-limiting (2A) and thermal protection features of the power switch eliminate the need for the fuse. VCC\_MODEM power supply is derived from the ZEUS +5V supply.

GSM\_ON and GPS\_ON control signals are provided on the ZEUS Modem connector (J23). They are controlled by on-board GPIO expander (see [On-Board GPIO expanders pin assignments](#), page 29). For details on how to use these signals, and other power management features of the specific wireless and GPS devices, please consult the datasheet of the device used.

### USB power management

A USB power control switch controls the power, and protects against short-circuit and over-current conditions, on USB host ports.

If the USB voltage VBUSx is short-circuited, or more than 500mA is drawn from any VBUSx supply, the switch turns off the power supply and protects the device and board automatically. The VBUSx power supplies are derived from the ZEUS +5V supply.

The following table shows the PXA270 assignments for power enable and over-current signals:

Host 1/2 functions	PXA270 GPIO	Active
USB_PWE1	GPIO89	High
USB_OC1#	GPIO88	Low
USB_PWE2	GPIO22	High
USB_OC2#	GPIO114	Low

### *Ethernet power management*

The Ethernet controllers (Davicom DM9000A) incorporate a number of features to maintain the lowest power consumption.

The device can be put into a power-reduced mode by setting the PHY control register bit 16.4. In power-reduced mode, the device transmits the fast link pulses with minimum power consumption. It also monitors the media for the presence of a valid signal and, if detected, the device automatically wakes up and resumes normal operation. The power consumption in power-reduced mode (without the cable) is 31mA.

The PHY can be put into a sleep mode by setting the PHY control register bit 16.1, which powers down all the circuits except the oscillator and clock generator circuit.

The PHY can be put into a power-down mode by setting the PHY control register bit 0.11, which disables all transmit and receive functions but not access to PHY registers. The power consumption in power-down mode is 63mW. The system clock can be turned off, by using the SCCR register (bit 0) of DM9000A, to further reduce the power consumption to 22mW.

For more information about power management, refer to the *DM9000A datasheet* on the Development Kit CD.

### *Audio power management*

The audio CODEC (Wolfson WM9712L) supports the standard power down control register defined by AC'97 standard (26h). In addition, the individual sections of the chip can be powered down through register 24h. Significant power savings can be achieved by disabling parts of WM9712L that are not used.

Shutting down all the clocks and digital and analogue sections can reduce WM9712L consumption down to near zero (1.65µW).

For more information about power management, refer to the *WM9712L datasheet* on the Development Kit CD.

### *LVDS power management*

If not used, the DS90C363 LVDS transmitter can be placed in power down mode by applying a low-level to GPIO21 of PXA270 (signal LVDS\_EN). The power consumption in power down mode is 180µW.

CPU_ GPIO21 (LVDS_EN)	LVDS operation status
0	Power down mode
1	Normal operation

### *CAN bus power management*

The Microchip MCP2515 CAN bus controller has an internal sleep mode that is used to minimize the current consumption of the device. The SPI interface remains active for reading even when the MCP2515 is in sleep mode, allowing access to all registers. To enter sleep mode, the mode request bits are set in the CANCTRL register (REQOP<2:0>).

When in internal sleep mode, the wake-up interrupt is still active (if enabled) which means that upon detecting activity on the bus, it can be used as a wake-up source for PXA270. When in sleep mode, the MCP2515 stops its internal oscillator. The MCP2515 will wake up when bus activity occurs, or when the PXA270 sets the CANINTF.WAKIF bit to 'generate' a wake-up attempt, via the SPI interface. The power consumption in sleep mode is near zero (15µW).

The transceiver device (MCP2551) may be placed in sleep mode by applying a high-level to GPIO2 of Expander 2 (I2C address 0x22, signal CAN\_SHDN). In sleep mode, the transmitter is switched off and the receiver operates at a lower current. The receive pin on the controller side (RXD) is still functional but will operate at a slower rate. The power consumption in sleep mode is 1.8mW.

EXP2_GPIO2 (CAN_SHDN)	MCP2551 operation status
0	Normal operation
1	Sleep mode

For more information about power management, refer to the *MCP2515* and *MCP2551 datasheets* contained on the Development Kit CD.

### *Clock generator power management*

Two clock synthesizer IC's (Cypress CY22381) can be placed in low power mode by shutting down the clock outputs in case the corresponding interfaces are not used. You can do this by applying a low-level to the GPIO0 pin on the Expander 2 (I2C address 0x22, signal CLK\_SHDOWN#). The following clocks are affected:

- ST16C554Q UART 14.7456MHz clock.
- Ethernet PHY 25MHz clock.
- PC/104 8MHz and 14MHz clocks.
- CAN bus 16MHz clock.
- Audio clock 24.576MHz.

This can reduce the power consumption of each clock generator IC down to 66 µW.

EXP2_GPIO0 (CLK_SHDOWN#)	Clock operation status
0	Shutdown mode
1	Normal operation

### COM Ports power management

RS232 transceivers can be placed in low power mode in case they are not used. This can reduce the power consumption of each RS232 transceiver down to 33  $\mu$ W. GPIO pins 3 and 4 of Expander 2 (I2C address 0x22) are used to shut down COM1 and COM2. GPIO pin 1 of Expander 1 (I2C address 0x21) is used to shut down COM3.

EXP2_GPIO3 (U1_RS232_SHDN#)	COM1 RS232 operation status
0	Shutdown mode
1	Normal operation
EXP2_GPIO4 (U2_RS232_SHDN#)	COM2 RS232 operation status
0	Shutdown mode
1	Normal operation
EXP1_GPIO1 (U3_RS232_EN)	COM3 RS232 operation status
0	RS232 Shutdown mode (RS422/485 enabled)
1	Normal operation

### Temperature sensor power management

The LM75A device can be set to operate in two modes: normal or shut-down. In normal operating mode, the temp-to-digital conversion is executed every 100ms and the Temp register is updated at the end of each conversion. In shut-down mode, the device becomes idle, data conversion is disabled and the Temp register holds the latest result. However, the device I<sup>2</sup>C interface is still active and register write/ read operation can be performed. The device operating mode is controllable by programming bit B0 of the configuration register. The temperature conversion is initiated when the device is powered-up or put back into normal mode from shut-down. The power consumption in shut-down mode is near zero (11.5 $\mu$ W).

For more information about power management, refer to the *LM75A datasheet* on the Development Kit CD.

### I/O expander power management

When the serial I<sup>2</sup>C interface is idle and the PWM intensity control is unused, the MAX7313 automatically enters standby mode. If the PWM intensity control is used, the operating current is slightly higher because the internal PWM oscillator is running. The power consumption in standby mode (with PWM disabled) is near zero (4 $\mu$ W).

### Configuration PROM power management

When the serial I<sup>2</sup>C interface is idle the 24AA01 automatically enters standby mode. The power consumption in standby mode is near zero (3.3 $\mu$ W).



# Connectors, LEDs and jumpers

The following diagram shows the location of the connectors, LEDs and jumpers on the ZEUS:

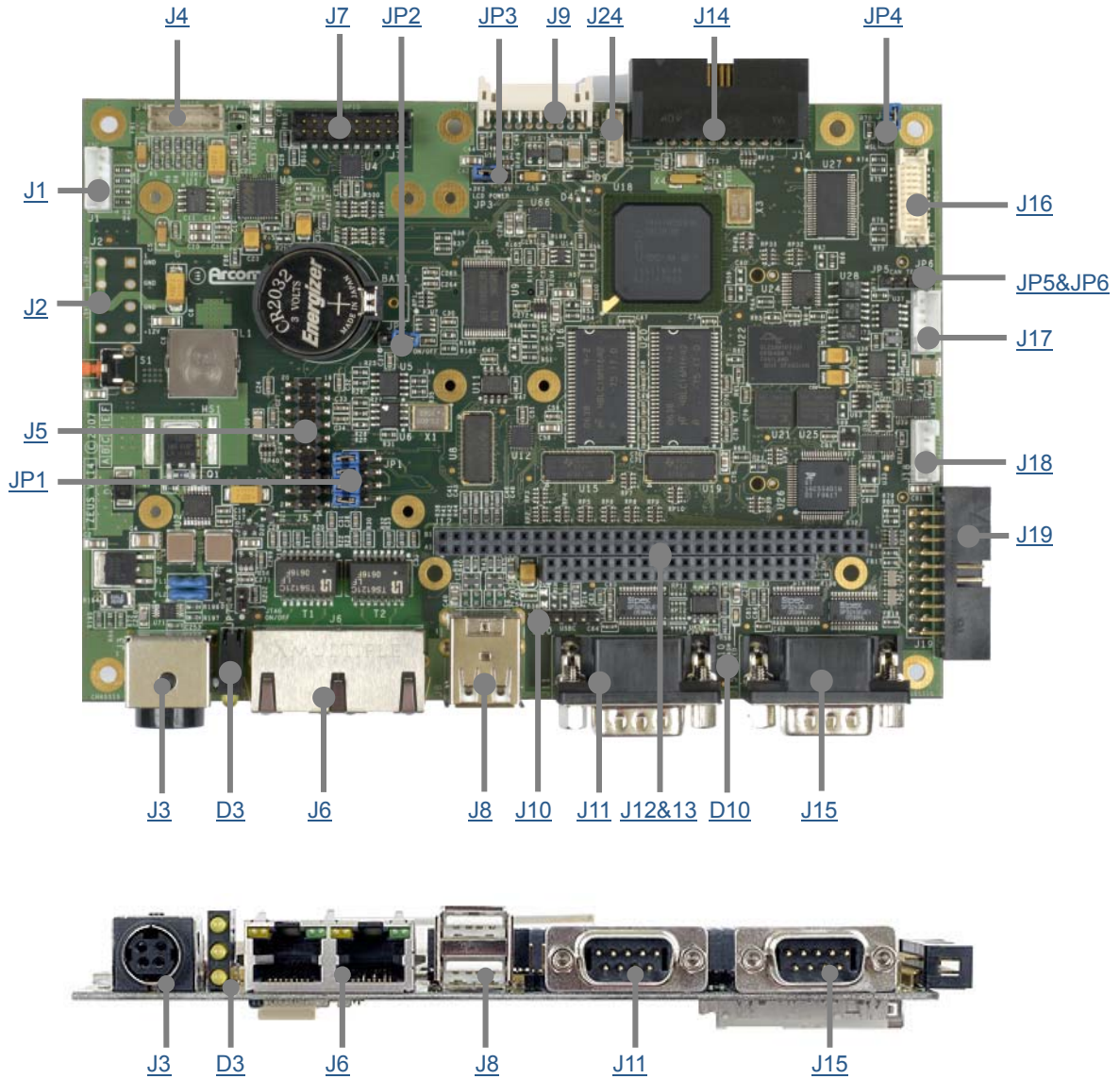



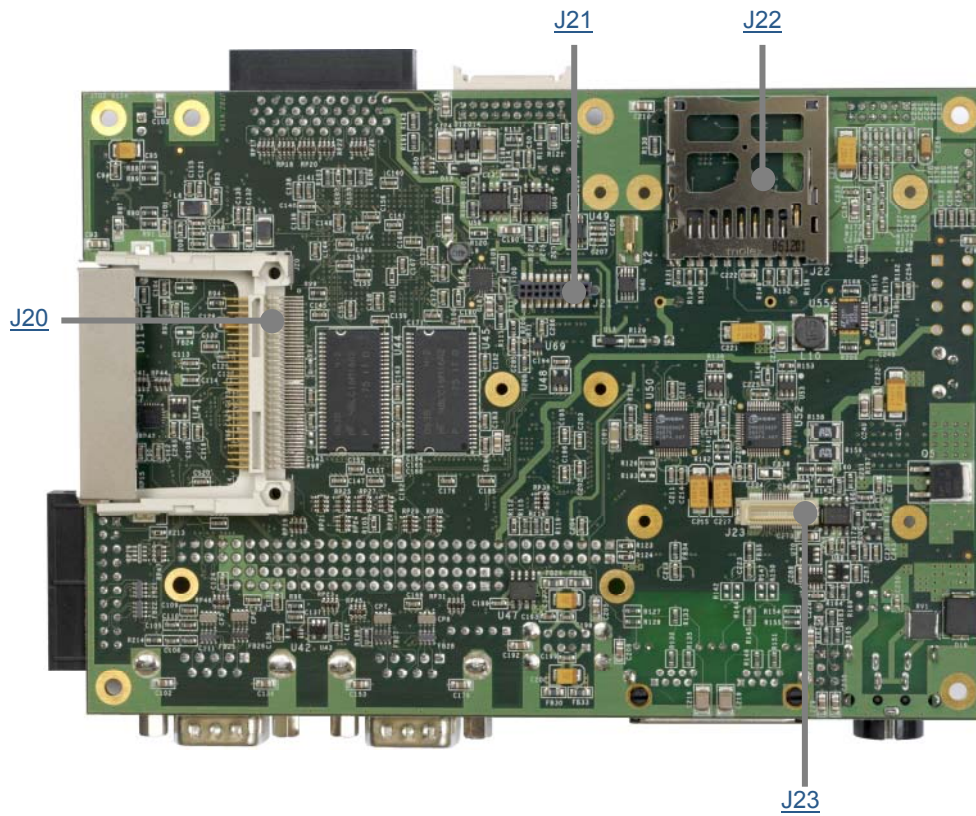

The connectors on the following pages are shown in the same orientation as the pictures above, unless otherwise stated.

---

## Connectors

There are 24 connectors on the ZEUS for accessing external devices:

Connector	Function	Connector details in section...
J1	Touchscreen controller	<a href="#">J1 – Touchscreen connector</a> , page <a href="#">77</a>
J2	Power (5V DC)	<a href="#">J2 – Power connector (5V option)</a> , page <a href="#">78</a>
J3	Power (10-30V DC)	<a href="#">J3 – Power connector (10-30V)</a> , page <a href="#">78</a> (Please note that J3 is not fitted when J2 is fitted. See the sections <a href="#">J2 – Power connector (5V option)</a> , page <a href="#">78</a> , and <a href="#">J3 – Power connector (10-30V)</a> , page <a href="#">78</a> , for details.)
J4	Audio	<a href="#">J4 – Audio connector</a> , page <a href="#">79</a>
J5	JTAG	<a href="#">J5 – JTAG</a> , page <a href="#">79</a>
J6	10/100BaseTX Ethernet	<a href="#">J6 – Ethernet connector</a> , page <a href="#">80</a>
J7	GPIO	<a href="#">J7 – GPIO</a> , page <a href="#">81</a>
J8	Dual USB host	<a href="#">J8 – USB</a> , page <a href="#">81</a>
J9	Camera interface	<a href="#">J9 – Camera interface connector</a> , page <a href="#">82</a>
J10	USB client	<a href="#">J10 – USB client header</a> , page <a href="#">82</a>
J11	Serial port – COM1	<a href="#">J11 – Serial port – COM1</a> , page <a href="#">83</a>
J12	64-way PC/104 expansion	<a href="#">J12 &amp; J13 – PC/104</a> , page <a href="#">84</a>
J13	40-way PC/104 expansion	<a href="#">J12 &amp; J13 – PC/104</a> , page <a href="#">84</a>
J14	LCD panel interface	<a href="#">J14 – LCD</a> , page <a href="#">85</a>
J15	Serial port – COM2	<a href="#">J15 – Serial port – COM2</a> , page <a href="#">86</a>
J16	LCD panel LVDS interface	<a href="#">J16 – LVDS</a> , page <a href="#">86</a>
J17	CAN bus	<a href="#">J17 – CAN bus</a> , page <a href="#">87</a>
J18	Serial port (RS422/485)	<a href="#">J18 – Serial port (RS485/422)</a> , page <a href="#">87</a>

*continued...*

Connector	Function	Connector details in section...
J19	Serial ports (COM3/4)	<a href="#">J19 – Serial ports – COM3/4</a> , page <a href="#">88</a>
J20	CF+ interface	<a href="#">J20 – CompactFlash</a> , page <a href="#">89</a>
J21	IEEE802.15.4 / ZigBee	<a href="#">J21 – IEEE802.15.4 / ZigBee connector</a> , page <a href="#">90</a>
J22	SDIO	<a href="#">J22 – SDIO socket</a> , page <a href="#">90</a>
J23	Wireless interface	<a href="#">J23 – Wireless modem/GPS module interface</a> , page <a href="#">91</a>
J24	Backlight power	<a href="#">J24 – Backlight power</a> , page <a href="#">92</a>

### J1 – Touchscreen connector

Connector: Neltron 2417SJ-5-F4, 5-way, 2mm (0.079") pitch wire-to-board header

Mating connector: Molex 87369-0500 2mm (0.079") pitch crimp housing

Mating crimps: Molex 50212

Pin	Signal name
1	TSRY+/TR
2	TSRY-/BL
3	TSRX+/BR
4	TSRX-/TL
5	TSW

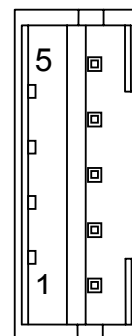

*J2 – Power connector (5V option)*

Connector: Neltron 5566S-08, 8-way, 4.2mm (0.165") pitch mini fit header

Mating connector: Molex 39-01-2085, 8-way, 4.20mm (0.165") pitch mini-fit, receptacle housing

Mating crimps: Molex 44476-1112

Pin	Signal name	Pin	Signal name
1	GND	5	+5V
2	GND	6	+5V
3	GND	7	+5V
4	+12V	8	NC

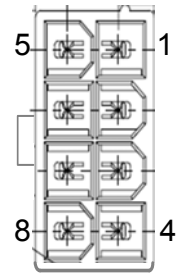

+12V connection is defined, but is not required for the ZEUS under normal operation. It can be used to supply +12V to the PC/104 stack if required.

J3 is not fitted when J2 is fitted.

*J3 – Power connector (10-30V)*

Connector: Kycon KPJX-4S-S, 4-way DC power socket

Mating connector: Kycon KPPX-4P plug

Pin	Signal name
1	PWR_IN
2	IGNITION
3	GND_IN
4	GND_IN

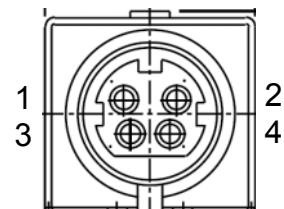

As viewed from the front panel



J2 is not fitted when J3 is fitted.

*J4 – Audio connector*

Connector: Neltron 2417SJ-12-PHD, 12-way, 2mm header

Mating connector: JST PHDR-12VS

Mating crimps: JST SPHD-002T-P0.5

Pin	Signal name	Pin	Signal name
1	LEFT IN	2	LEFT OUT
3	GND	4	GND
5	RIGHT IN	6	RIGHT OUT
7	GND	8	AMP LEFT OUT
9	MIC VREF OUT	10	MIC IN
11	AMP RIGHT OUT	12	GND

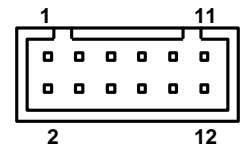

*J5 – JTAG connector*

Connector: Oupiin 2015-2x10-G-D W/ROHS, 20-way, 2.54mm (0.1") header

Mating connector: FCC 71600-020LF

Pin	Signal name	Pin	Signal name
1	+3V3	2	NC
3	TRST#	4	GND
5	TDI	6	GND
7	TMS	8	GND
9	TCLK	10	GND
11	NC	12	GND
13	TDO	14	GND
15	SRST#	16	GND
17	NC	18	GND
19	NC	20	GND

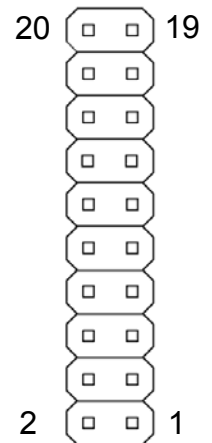

*J6 – Ethernet connector*

Connector: Dual RJ45 shielded with LEDs, [Xmultiple XRJM-S-02-8-8-1](#)

Pin	Signal name	Pin	Signal name
1A	TX0+	1B	TX1+
2A	TX0-	2B	TX1-
3A	RX0+	3B	RX1+
4A	N.C.	4B	N.C.
5A	N.C.	5B	N.C.
6A	RX0-	6B	RX1-
7A	N.C.	7B	N.C.
8A	N.C.	8B	N.C.
9A	LED0_SPEED#	9B	LED1_SPEED#
10A	+3V3	10B	+3V3
11A	LED0_LINK#	11B	LED1_LINK#
12A	+3V3	12B	+3V3

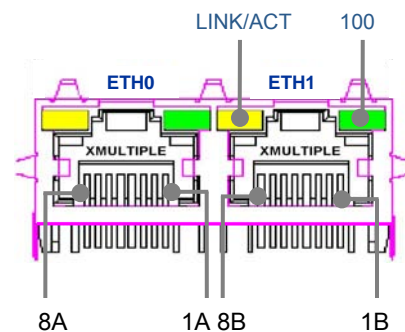

As viewed from the front panel

*J7 – GPIO connector*

Connector: Molex 87832-2020, 20-way, 2mm (0.079") header

Mating connector: Molex 51110-2051, 2mm (0.079") pitch, milli-grid crimp housing

Mating crimps: Molex 50394

Pin	Signal name	Pin	Signal name
1	+5V	2	+5V
3	P0	4	P1
5	P2	6	P3
7	P4	8	P5
9	P6	10	P7
11	GND	12	GND
13	P8	14	P9
15	P10	16	P11
17	P12	18	P13
19	P14	20	P15

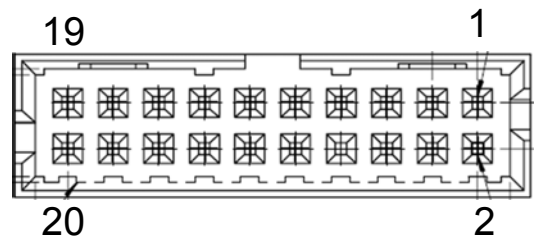

*J8 – USB connector*

Connector: USB type A dual stacked connector

Pin	Signal name	Pin	Signal name
1	VBUS1	5	VBUS2
2	D1-	6	D2-
3	D1+	7	D2+
4	GND	8	GND

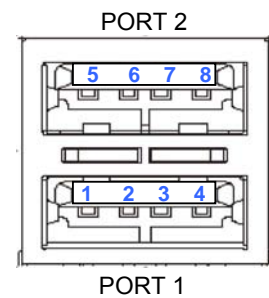

As viewed from the front panel

**J9 – Camera interface connector**

Connector: Neltron 2417RJ-20-PHD 'LEAD FREE', 20-way, 2mm (0.079") header

Mating connector: JST PHDR-20VS

Mating crimps: JST SPHD-002T-P0.5

Pin	Signal name	Pin	Signal name
1	+3V3	2	+2V8
3	CIF_MCLK	4	CIF_PCLK
5	CIF_LV	6	CIF_FV
7	CIF_DD0	8	CIF_DD1
9	CIF_DD2	10	CIF_DD3
11	CIF_DD4	12	CIF_DD5
13	CIF_DD6	14	CIF_DD7
15	I2C_SCL	16	I2C_SDA
17	CIF_DD8	18	CIF_DD9
19	GND	20	GND

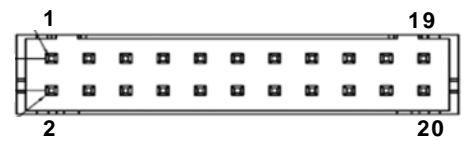

As viewed from the connector pins

**J10 – USB client header**

Connector: Oupiin 2011-1x5-G-S W/ROHS, 2.54mm (0.1") header

Mating connector: Molex 22-01-2055 2.54mm (0.1") pitch crimp terminal housing

Mating crimps: Molex 4809

Pin	Signal name
1	NC
2	D2-
3	D2+
4	GND
5	GND





*J11 – Serial port – COM1*

Connector: 9-pin D-type Plug male type

Pin	Signal name
1	DCD1
2	RX1
3	TX1
4	DTR1
5	GND
6	DSR1
7	RTS1
8	CTS1
9	RI1

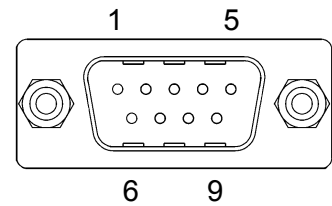

*J12 & J13 – PC/104 connectors*

Connector:

- Samtec ESQ-132-12-G-D, 64-way, 2.54mm (0.1") PC/104 compatible connector (row A & B)
- Samtec ESQ-120-14-G-D, 40-way, 2.54mm (0.1") PC/104 compatible connector (row C & D)

J13			J12				
Pin	Row D	Row C	Pin	Row A	Row B		
			1	IOCHCK#	GND		A1 B1
			2	D7	RSTDRV		
			3	D6	+5V		
			4	D5	IRQ9		
			5	D4	NC		
			6	D3	NU (DRQ2)		
			7	D2	NC		
			8	D1	NC		
0	GND	GND	9	D0	+12V		D0 C0
1	MEMCS16#	SBHE#	10	IOCHRDY	KEY		
2	IOCS16#	LA23	11	AEN	SMEMW#		
3	IRQ10	LA22	12	A19	SMEMR#		
4	IRQ11	LA21	13	A18	IOW#		
5	IRQ12	LA20	14	A17	IOR#		
6	IRQ15	LA19	15	A16	NU (DACK3)		
7	IRQ14	LA18	16	A15	NU (DRQ3)		
8	NU (DACK0)	LA17	17	A14	NU (DACK1)		
9	NU (DRQ0)	MEMR#	18	A13	NU (DRQ1)		
10	NU (DACK5)	MEMW#	19	A12	NU (REFSH)		
11	NU (DRQ5)	D8	20	A11	8MHz Clk		
12	NU (DACK6)	D9	21	A10	IRQ7		
13	NU (DRQ6)	D10	22	A9	IRQ6		
14	NU (DACK7)	D11	23	A8	IRQ5		
15	NU (DRQ7)	D12	24	A7	IRQ4		
16	+5V	D13	25	A6	IRQ3		
17	NC (Master)	D14	26	A5	NU (DACK2)		
18	GND	D15	27	A4	NU (TC)		
19	GND	KEY	28	A3	BALE		
			29	A2	+5V		D C 19 19
			30	A1	OSC		
			31	A0	GND		
			32	GND	GND		A B 32 32

NU – Not Used

*J14 – LCD connector*

Connector: Oupiin 3214-40GRB, 40-way, 1.27mm (0.05") x 2.54mm (0.1") right angled boxed header

Mating connector: Oupiin 1203-40GB (available from [Eurotech Sales](#) on request - see page [97](#) for contact details)

Pin	Signal name	Pin	Signal name
1	BKLEN	2	BKLSAFE
3	PWM0	4	LCDSAFE
5	NEGBIAS	6	POSBIAS
7	GND	8	GND
9	FPD1	10	FPD0
11	FPD3	12	FPD2
13	FPD5	14	FPD4
15	GND	16	GND
17	FPD7	18	FPD6
19	FPD9	20	FPD8
21	FPD11	22	FPD10
23	GND	24	GND
25	FPD13	26	FPD12
27	FPD15	28	FPD14
29	FPD17	30	FPD16
31	GND	32	GND
33	BIAS / DE	34	GND
35	FCLK / VSYNC	36	GND
37	LCLK / HSYNC	38	GND
39	PCLK / CLOCK	40	GND

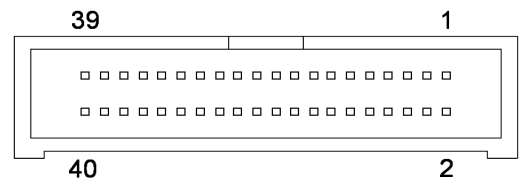

As viewed from the connector pins

**J15 – Serial port – COM2**

Connector: 9-pin D-type plug, male type

Pin	Signal name
1	DCD2
2	RX2
3	TX2
4	DTR2
5	GND
6	DSR2
7	RTS2
8	CTS2
9	RI2

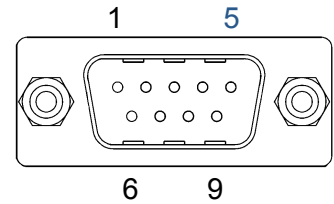

**J16 – LVDS connector**

Connector: Hirose DF13-20DP-1.25V(55), 1.25mm pitch double row straight pin header

Mating connector: Hirose DF13-20DS-1.25C

Mating crimps: Hirose DF13-2630SCFA

Pin	Signal name	Pin	Signal name
1	+3V3	2	+3V3
3	GND	4	GND
5	LVDS_D0-	6	LVDS_D0+
7	GND	8	LVDS_D1-
9	LVDS_D1+	10	GND
11	LVDS_D2-	12	LVDS_D2+
13	GND	14	LVDS_CLK-
15	LVDS_CLK+	16	GND
17	NC	18	NC
19	GND	20	MSL

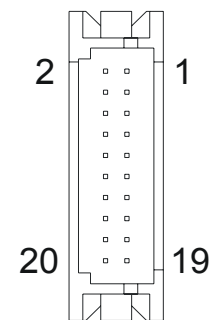

**J17 – CAN bus**

Connector: Neltron 2417SJ-5-F4, 5-way, 2mm (0.079") pitch wire-to-board header

Mating connector: Molex 87369-0500 2mm (0.079") pitch crimp housing

Mating crimps: Molex 50212

Pin	Signal name
1	VCC_CAN (+5V)
2	CANH
3	CAN_SCRN
4	CANL
5	GND

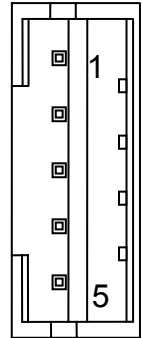
**J18 – Serial port (RS485/422) – COM3**

Connector: Neltron 2417SJ-5-F4, 5-way, 2mm (0.079") pitch wire-to-board header

Mating connector: Molex 87369-0500 2mm (0.079") pitch crimp housing

Mating crimps: Molex 50212

Pin	Signal name
1	TX3- (RS422) RX3/TX3- (RS485)
2	TX3+ (RS422) RX3/TX3+ (RS485)
3	RX3- (RS422)
4	RX3+ (RS422)
5	GND

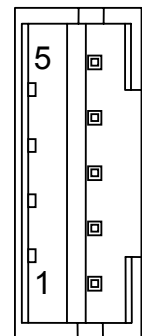

*J19 – Serial ports – COM3/4*

Connector: Oupiin 3012-20GRB W/ROHS, 20-way, 2.54mm (0.1") dual row IDC boxed header

Mating connector: FCC 71600-020LF

Pin	Signal name	Pin	Signal name
1	I2C_SCL	2	I2C_SDA
3	GND (I <sup>2</sup> C )	4	3.3V (I <sup>2</sup> C )
5	TX4+ (RS422) (TX4+/RX4+ RS485)	6	TX4- (RS422) (TX4-/RX4- RS485)
7	RX4+ (RS422)	8	RX4- (RS422)
9	GND	10	GND
11	DCD3	12	DSR3
13	RX3	14	RTS3
15	TX3	16	CTS3
17	DTR3	18	RI3
19	GND	20	NC

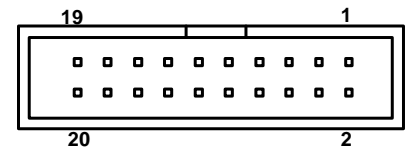

As viewed from the connector pins

*J20 – CompactFlash connector*

Connector: 3M N7E50-M516RB-50, 50-way CompactFlash type II connector

Pin	Signal name	Pin	Signal name
1	GND	2	D3
3	D4	4	D5
5	D6	6	D7
7	CE1#	8	A10
9	OE#	10	A9
11	A8	12	A7
13	+3.3V	14	A6
15	A5	16	A4
17	A3	18	A2
19	A1	20	A0
21	D0	22	D1
23	D2	24	IOCS16#
25	CD2#	26	CD1#
27	D11	28	D12
29	D13	30	D14
31	D15	32	CE2#
33	GND	34	IORD#
35	IOWR#	36	WE#
37	RDY/BSY	38	+3.3V
39	GND	40	NC
41	RESET#	42	WAIT
43	NC	44	REG#
45	NC	46	NC
47	D8	48	D9
49	D10	50	GND

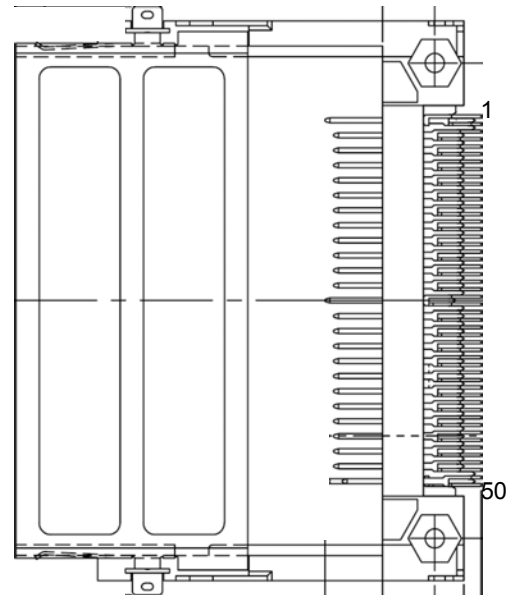

*J21 – IEEE802.15.4 / ZigBee connector*

Connector: Harwin M50-4321005, 20-way, 1.27mm dual row socket

Mating connector: M50-4921005, 20-way, 1.27mm dual row header

Pin	Signal name	Pin	Signal name
1	+3V3	2	+3V3
3	GND	4	GND
5	NC	6	RESET#
7	ZB_BTRXD	8	ZB_BTTXD
9	ZB_BTCTS#	10	ZB_BTRTS#
11	NC	12	NC
13	NC	14	NC
15	NC	16	NC
17	NC	18	NC
19	NC	20	NC

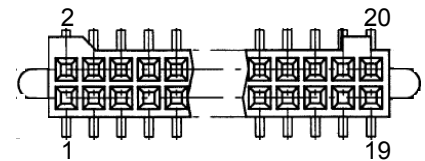

*J22 – SDIO socket*

Connector: Molex 67913-0002, 2.50mm (0.098") Pitch SDIO Memory Card Connector, Reverse-Mount Type

Pin	Signal name
1	MMDAT3
2	MMCMD
3	GND
4	+3V3
5	MMCLK
6	GND
7	MMDAT0
8	MMDAT1
9	MMDAT2
10	MMC_WP
11	+3V3
12	MMC_CD

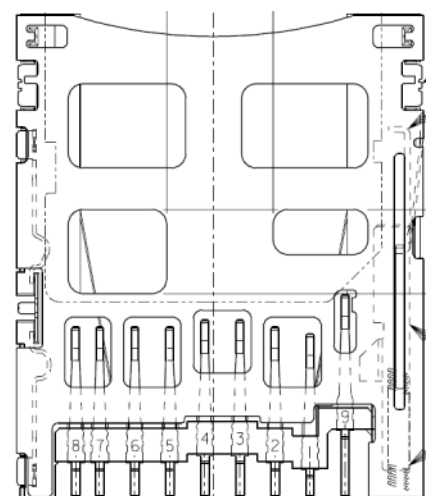



*J23 – Wireless modem/GPS module interface*

Connector: Hirose DF17(4.0)-40DP-0.5V(57), 40-way, 0.5mm pitch header

Mating connector: Hirose DF17(3.0)-40DS-0.5V(51), 40-way, 0.5mm pitch socket

Pin	Signal name	Pin	Signal name
1	VCC_MODEM	2	VCC_MODEM
3	VCC_MODEM	4	VCC_MODEM
5	VCC_MODEM	6	VCC_MODEM
7	VCC_MODEM	8	VCC_MODEM
9	VCC_MODEM	10	VCC_MODEM
11	VCC_MODEM	12	GSM_STS
13	GSM_FF_TXD	14	GSM_FF_RXD
15	GSM_FF_DTR#	16	GSM_FF_DSR#
17	GSM_FF_RTS#	18	GSM_FF_RI#
19	GSM_ON	20	GSM_FF_DCD#
21	PTT	22	GSM_FF_CTS#
23	GPS_PSUON	24	GPS_BOOT
25	+3V3	26	+3V3
27	GPS_ON	28	GPS_PPS
29	GPS_STD_TXD	30	GPS_STD_RXD
31	GND	32	GND
33	GND	34	GND
35	GND	36	GND
37	GND	38	GND
39	GND	40	GND

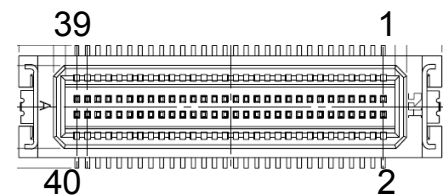

If you require a custom wireless modem adapter, please contact the [Eurotech Sales](#) team (see page [97](#)).

*J24 – Backlight power (for flat panel displays)*

Connector: Molex 53047-0710, 7-way 1.25mm (0.049") pitch header with friction lock

Mating connector: Molex 51021-0700, 7-way 1.25mm (0.049") housing, female

Mating crimps: Molex 50058

Pin	Signal name
1	BKLSAFE
2	BKLSAFE
3	GND
4	GND
5	BKLEN
6	BRT_CTRL
7	GND

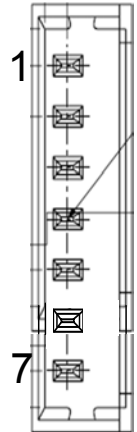

## Jumpers

There are six user selectable jumpers on the ZEUS. Their use is explained below.

### JP1 – User jumpers

Connector: 8-way, 2.54mm (0.1") dual row through-hole header

Pin	Signal name	Pin	Signal name	GPIO
1	GND	2	USER_LINK1	CPU_GPIO 13
3	GND	4	USER_LINK2	CPU_GPIO 102
5	GND	6	USER_LINK3	EXP1_GPIO 6
7	GND	8	USER_LINK4	EXP1_GPIO 14

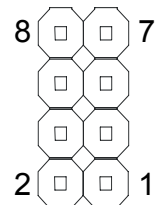

These are four user configurable jumpers connected to GPIO pins of PXA270 and MAX7313 GPIO Expander 1.

JP1	Description
	GPIO read as '0'
	GPIO read as '1' (Default)



User jumpers 1 and 2 (GPIO 13 and 91) may be connected to an external momentary push switch and used to wake the ZEUS from sleep.

### JP2 – Battery disconnect

Connector: 2-way, 2.54mm (0.1") through-hole header

Pin	Signal name
1	Battery Plus Terminal
2	Battery Backup switch input

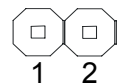

Normally supplied with jumper removed.

This jumper is used to disconnect the backup battery to prevent it from draining.

JP2	Description
	Battery connected
	Battery disconnected (default)

**JP3 – LCD logic supply selection**

Connector: 3-way, 2.54mm (0.1") single row through-hole header

Pin	Signal name
1	+5V
2	LCD Logic Supply
3	+3V3

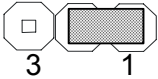
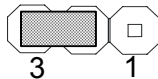

This jumper selects the supply voltage for the LCD logic supply.

JP3	Description
	Supply LCD Logic with 5V
	Supply LCD Logic with 3.3V (Default)



If the LCD requires a 5V supply, please refer to the *LCD datasheet* to ensure that the display is compatible with 3.3V logic.



**JP4 – LVDS MSL selection**

Connector: 2-way, 2.54mm (0.1") through-hole header

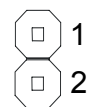
Pin	Signal name
1	MSL
2	3.3V



This is an optional LVDS Mode select signal (routed to LVDS connector J16, pin 20).

JP4	Description
	MSL set to '1'
	MSL set to '0' (Default)

**JP5 & JP6 – CAN bus termination**

Connector: 2-way, 2.54mm (0.1") through-hole header

JP5		JP6	
Pin	Signal name	Pin	Signal name
1	CANH	1	Centre tap
2	Centre Tap	2	CANL

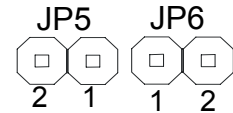

JP5 & JP6	Description
	62Ω Termination connected
	62Ω Termination disconnected (default)



Only insert jumpers JP5 and JP6 if the ZEUS is at the end of the network.

**JP7 - JTAG Enable**

Connector: 2-way, 2.54mm (0.1") through-hole header

Pin	Signal name
1	VCC (+5V)
2	VCC_JTAG

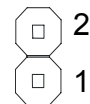

This jumper is used to enable debug of PXA270 using JTAG interface.

JP7	Description
	JTAG Enable
	Normal Operation (Default)



Only insert jumper JP7 for JTAG access to PXA270.

## Status LEDs

### Flash LED

There is a single status LED (D10) on the ZEUS, which indicates access to the Flash memory.

### User LEDs

There are three user LEDs on the ZEUS front panel (D3). They are connected to the GPIO pins of the on-board GPIO Expander 1 MAX7313 (I<sup>2</sup>C bus address 0x21), as shown in the table below:

EXP1_GPIO	Signal name	Active
3	USER_LED1#	Low
4	USER_LED2#	Low
5	USER_LED3#	Low

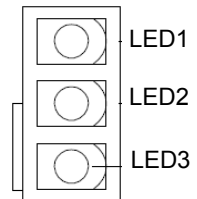

As viewed from the front panel

## Appendix A - Contacting Eurotech

### Eurotech sales

Eurotech's sales team is always available to assist you in choosing the board that best meets your requirements.

Eurotech Ltd  
3 Clifton Court  
Cambridge  
CB1 7BN  
UK

Tel: +44 (0)1223 403410

Fax: +44 (0)1223 410457

Email: [sales@eurotech-ltd.co.uk](mailto:sales@eurotech-ltd.co.uk)

Comprehensive information about our products is also available at our web site:

[www.eurotech-ltd.co.uk](http://www.eurotech-ltd.co.uk).



While Eurotech's sales team can assist you in making your decision, the final choice of boards or systems is solely and wholly the responsibility of the buyer. Eurotech's entire liability in respect of the boards or systems is as set out in Eurotech's standard terms and conditions of sale. If you intend to write your own low level software, you can start with the source code on the disk supplied. This is example code only to illustrate use on Eurotech's products. It has not been commercially tested. No warranty is made in respect of this code and Eurotech shall incur no liability whatsoever or howsoever arising from any use made of the code.

---

### Eurotech technical support

Eurotech has a team of dedicated technical support engineers available to provide a quick response to your technical queries.

Tel: +44 (0)1223 412428

Fax: +44 (0)1223 410457

Email: [support@eurotech-ltd.co.uk](mailto:support@eurotech-ltd.co.uk)

### Eurotech Group

Eurotech Ltd is a subsidiary of Eurotech Group. For further details see

[www.eurotech.com](http://www.eurotech.com)

## Appendix B - Specification

### Microprocessor

- PXA270 312/416/520MHz processor (520MHz as standard option).

### Cache

- 32K data cache, 32K instruction cache, 2K mini data cache.

### System memory

- Fixed on-board memory: 64/128MB/256MB SDRAM (32-bit wide SDRAM data bus).

### Flash memory

- Fixed on-board memory: 32/64MB Flash.

### SRAM

- 256KB of SRAM - battery backed on board.
- 256KB of SRAM internal to PXA270.

### Serial ports

- 4x UART fast serial ports:
  - 4x 16550 compatible UARTs (921.6 Kbaud):
  - 1x RS422/485 (software selectable).
  - 1x RS232/422/485 (software selectable).
  - 2x RS232.

### USB support

- 2x USB 1.1 host controller ports.
- USB 1.1 client controller port (software selectable on port 2).

### Network support

- 2x IEEE 802.3u 10/100Base-T Ethernet controllers.
- Option for external PoE.

### Wireless support

- GPS with full PVT functionality on low profile add-on module.
- GSM/GPRS, iDEN, CDMA modem on low profile add-on module.
- IEEE802.15.4 / ZigBee radio interface on low profile add-on module.

### Expansion interfaces

- Compact Flash CF+ extension socket.
- SDIO socket to support MMC/SD/SDIO cards.
- 16-bit PC/104 interface.

### Date/time support

- Real time clock – battery backed on-board.
- Accuracy +/- 1min/month.



#### Video

- 18-bit flat panel interface for STN and TFT displays.
- Optional LVDS interface.

#### Audio and touchscreen

- AC'97 compatible CODEC.
- Touchscreen support – 4/5-wire analogue resistive.

#### Quick Capture camera interface

- Intel Quick Capture technology.

#### I<sup>2</sup>C bus

- Multi-master serial bus.

#### Configuration EPROM

- I<sup>2</sup>C EPROM for storing configuration data.

#### CAN bus

- Optional CAN 2.0B protocol controller and opto-isolated transceiver.

#### Watchdog timer

- External to PXA270, generates reset on timeout. Timeout range 1ms-60s.

#### General I/O

- 16 x general purpose I/O.

#### Temperature sensor

- I<sup>2</sup>C temperature sensor.

#### User LEDs

- Front panel user LEDs (3x yellow).

#### Test support

- JTAG interface (standard 20-pin ARM header).

#### Power requirements

- 5V +/-5% operation (ATX style connector) or vehicle compatible 10-30V input (front panel connector).
- Consumption: 2W typical (no CF, LCD, PC/104, USB devices fitted).
- Sleep mode: 20mA (100mW) typical.

#### Mechanical

- EPIC form factor (115mm x 165mm).

#### Environmental

- Operating temperature:
  - Commercial: -20°C (-4°F) to +70°C (+158°F).
  - Industrial: -40°C (-40°F) to +85°C (+185°F).
- Humidity: 10% to 90% RH (non-condensing).
- RoHS Directive (2002/95/EC) compliant.

# Appendix C - Mechanical diagram

All dimensions are shown in mm.

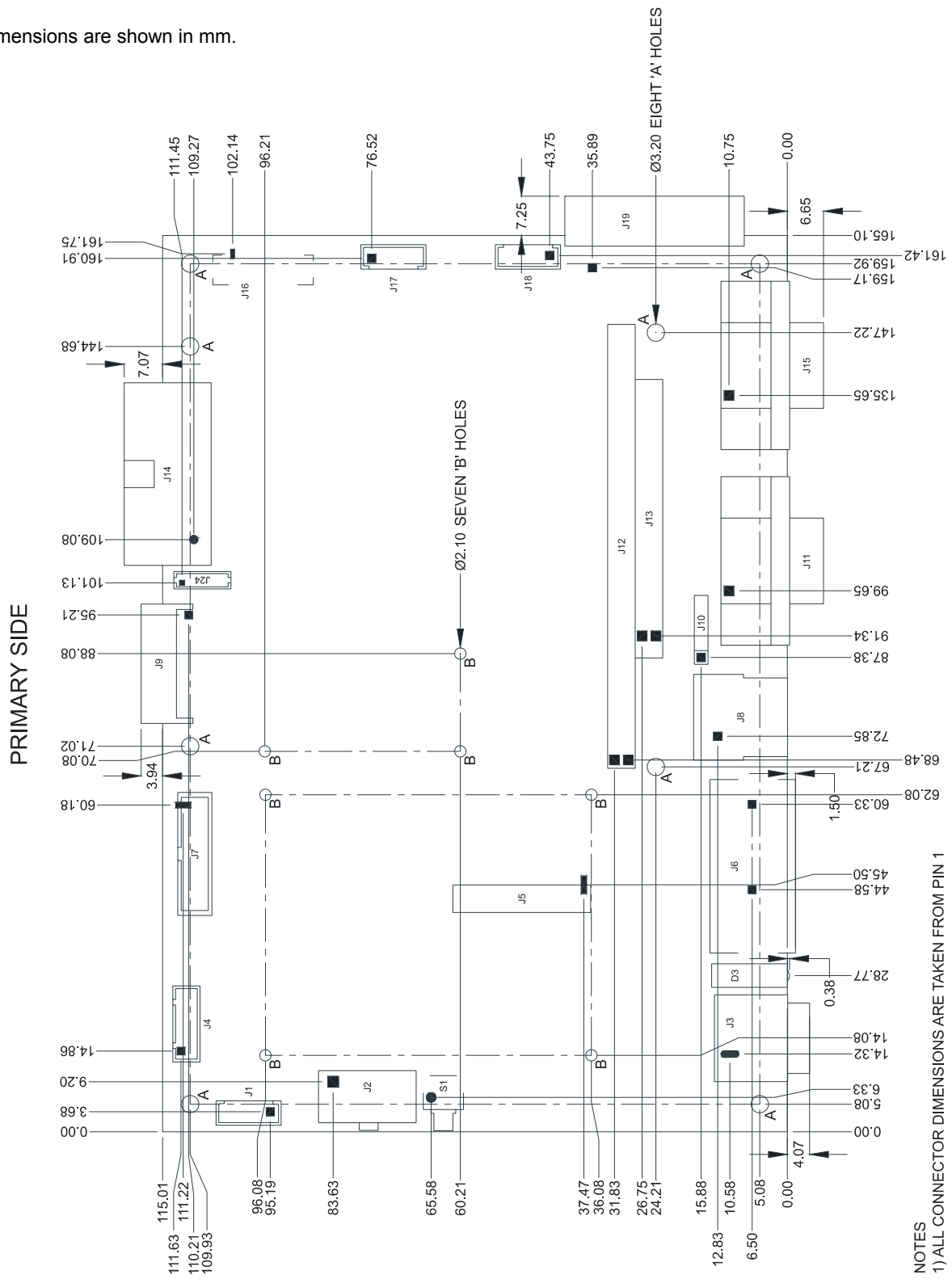

NOTES  
1) ALL CONNECTOR DIMENSIONS ARE TAKEN FROM PIN 1

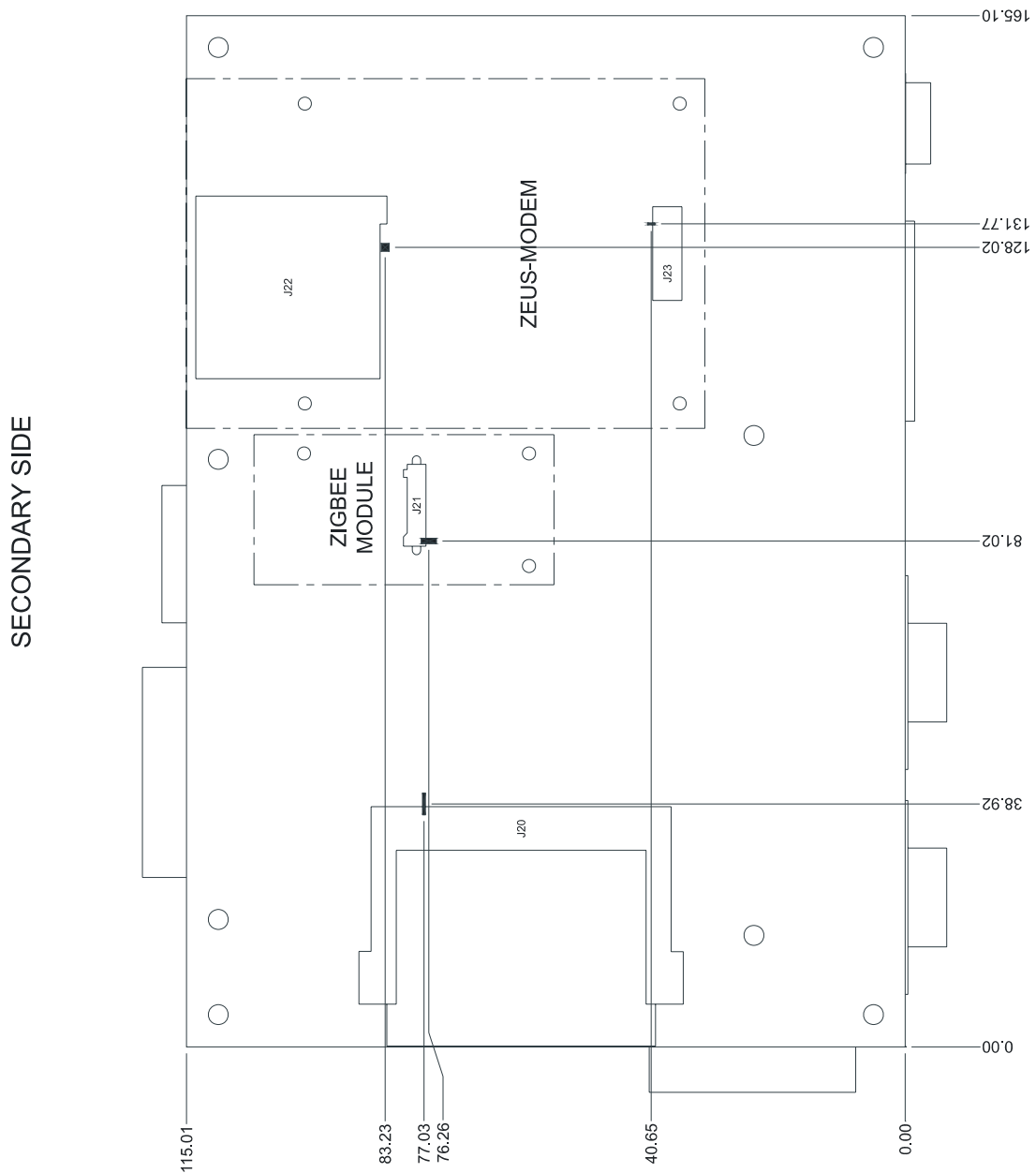

NOTES  
 1) ALL CONNECTOR DIMENSIONS ARE TAKEN FROM PIN 1



When mounting the ZEUS use only M3 (metric) or 4-40 (Imperial) screws. The mounting pad is 6.35mm (0.25") and the hole is 3.175mm (0.125"), so ensure any washers fitted are smaller than the pad.

Using oversized screws and washers, or tooth locking washers, can cause short circuits and over-voltage conditions.

We recommend that you use a Loctite screw thread lock or a similar product over tooth locking washers.

## Appendix D - Reference information

### *Product information*

Product notices, updated drivers, support material, 24hr-online ordering:

[www.eurotech-ltd.co.uk](http://www.eurotech-ltd.co.uk)

### *EPIC information*

Embedded Platform for Industrial Computing:

[www.pc104.org/technology/PDF/EPIC\\_Spec\\_2.0.pdf](http://www.pc104.org/technology/PDF/EPIC_Spec_2.0.pdf)

### *PC/104 Consortium*

PC/104 Specifications - vendor information and available add on products:

[www.pc104.org](http://www.pc104.org)

### *USB information*

Universal Serial Bus (USB) specification and product information:

[www.usb.org](http://www.usb.org)

### *SDIO card information*

SD Card Association and product information:

[www.sdcard.org](http://www.sdcard.org)

[www.sdcard.com](http://www.sdcard.com)

### *CompactFlash information*

CompactFlash Association and product information:

[www.compactflash.org](http://www.compactflash.org)

### *ZigBee information*

ZigBee Alliance:

[www.zigbee.org](http://www.zigbee.org)

### *Davicom Semiconductor Inc*

Davicom DM9000A Ethernet Controller documentation:

[www.davicom.com.tw/eng/index.htm](http://www.davicom.com.tw/eng/index.htm)

*Intel*

PXA270 processor documentation:

[www.intel.com](http://www.intel.com)

*Marvell*

PXA270 processor documentation:

[www.marvell.com](http://www.marvell.com)

*Exar Corporation*

Exar XR16C554DCQ Quad UART documentation:

[www.exar.com](http://www.exar.com)

*Wolfson Microelectronics*

Wolfson WM9712L AC'97Codec documentation:

[www.wolfson.co.uk](http://www.wolfson.co.uk)

*Spansion*

S29GL-N MirrorBit™ Flash Family documentation:

[www.spansion.com](http://www.spansion.com)

*Intersil*

RTC ISL1208 documentation:

[www.intersil.com](http://www.intersil.com)

*Microchip*

CAN Bus Controller/Transceiver MPC2515/MPC2551 documentation and 24AA01 EEPROM documentation:

[www.microchip.com](http://www.microchip.com)

*Maxim*

GPIO Expander MAX7313 documentation:

[www.maxim-ic.com](http://www.maxim-ic.com)

*Philips*

Temperature Sensor LM75A documentation:

[www.philips.com](http://www.philips.com)

# Appendix E - Wireless modem datasheets

## Sony Ericsson GR64

**Features:**

-  **Compact Size**
-  **850+900+1800+1900 Quad Band**
-  **GSM/GPRS Class 10**
-  **V24 2x UART Connectivity**  
for use through embedded applications
-  **Integrated TCP/IP Stack**
-  **Embedded Applications**
-  **RoHS Compliant**
-  **CE/GCF + FCC/PTCRB Fully Type Approved**



### GR64 GSM/GPRS Radio Device



**Benefits**

- Functionality comparable to the GM47/GM48 and GR47/GR48 Radio Devices for Legacy users
- Powerful and fast enabling complex and time critical applications
- Minimize total solution cost by embedding application directly onto GR64

Optimized for global M2M communications, the GR64 is a Quad Band (850/900/1800/1900) GSM/GPRS Class 10 compact Radio Device. Functionality comparable to the Sony Ericsson GM47/GM48 and GR47/GR48 Radio Devices, the GR64 offers a broad range of voice and data features. Its intrinsic TCP/IP stack enables customers to make effective use of GPRS. The GR64 is configurable and possesses an extended range of input/output capabilities.

With its exceptionally powerful processor and enhanced memory, the GR64 is ideal for a broad spectrum of M2M communication solutions. It is also suitable for a wide range of telemetry applications including fleet and asset management, POS, vending, security, metering and other solutions.

Sony Ericsson's Universal Developer's Kit can be used with the GR64 to simplify application development. The kit provides everything required to design and develop innovative applications and to bring them to market in rapid time.

In line with EU RoHS Directives on the environment, the GR64 is a Lead Free design.

Sony Ericsson distributor and Competence Center  
 CEP AG – Cellulare Produkte  
 Raiffeisenallee 12b, 82081 Oberhaching – Germany  
[www.cepag.de](http://www.cepag.de) – [info@cepag.de](mailto:info@cepag.de)  
 Phone: +49 (0) 89 4502 92 -0 or -29



Expanding Wireless Possibilities

Expanding Wireless Possibilities

## GR64 GSM/GPRS Radio Device

### Radio Features

- Quad Band GSM/GPRS
  - GSM 850/900 Power class 4 (33dBm)
  - GSM 1800/1900 Power class 1 (30dBm)
- Mobile Class B
- Extended Measurement Reporting
- Compliant with 3GPP Release 99 Protocol Stack
- Power supply: 3.2 – 4.5 VDC
- Battery charging support
- Overall dimensions (excluding connectors):
  - 50 x 33 x 3.2mm
- Temperature range:
  - -30°C to +75°C (Operational)
  - -40°C to +85°C (Storage temperature)
- Weight: 9g

### Interfaces

- Dual microphone inputs and speaker outputs
- Up to 15 x Programmable General Purpose I/Os
- 4 x ADC inputs
- 1 x buzzer output
- SPI Interface
- Real time clock with alarm output
- 2 UARTs
  - Serial baud rate from 1200 to 460,800 bits/s
  - Auto baud
  - Parity, data and stop bit programmable
- USB (2.0 Full-Speed End-Point Compliant)
- MMCX RF connector
- 60 Pin system connector as on GM47/GM48 and GR47/GR48
- Control by AT commands (GSM 27.005, 27.007 plus proprietary commands)

### Data Features

- GPRS Class 10
  - Multiple simultaneous PDP contexts
  - GPRS Coding Schemes CS1-CS4
- Transparent and non-transparent CSD up to 9.6 kbps
- Modem Type; V21, V22, V23, V22bis, V26ter, V32, V34, V24
- V42bis compression
- GSM supplementary services supported
- GSM 27.010 Multiplexing Protocol
- USSD

### Short Message Service (SMS) Features

- Text and PDU
- Point to point (MT/MO)
- Cell Broadcast

### Voice Features

- Voice Telephony
- Emergency calls
- Full Rate, Enhanced Full Rate, Half Rate and Adaptive Multi-rate (FR/EFR/HR/AMR)
- Noise suppression and echo cancellation
- Sidetone/microphone amplification
- PCM Audio

### Embedded Applications

- Multiple UART access
- Embedded application script downloads over the air using GPRS
- Embedded script interpreter
- Normal and controller mode
- Our M2mpower software facilitates the development of cost effective wireless M2M applications

### Internet Protocols

- TCP/IP protocol stack
  - Extensive AT Command access to TCP/IP stack
  - Multiple sockets with listening/server capability
  - IPv4 protocol
- Dynamic & Static IP address allocation
- PPP protocol (PAP)
- UDP protocol
- FTP client – File Transfer Protocol (file transfers)

### Other Features

- SIM Application Toolkit Class 2
- 1.8/3V SIM interface with SIM detection
- Optional SIM holder
- Dual SIM support with switching
- LED output
- Keypad Matrix (4x4)

### Universal Developer's Kit

- Our Universal Developer's Kit is available for rapid evaluation of products and applications on a limited scale

Note: Specification is preliminary and subject to change without prior notice.

# Sony Ericsson

Email: [m2minfo@SonyEricsson.com](mailto:m2minfo@SonyEricsson.com)  
 Website: [www.SonyEricsson.com/m2m](http://www.SonyEricsson.com/m2m)

© 2005 Sony Ericsson Mobile Communications AB.  
 All rights reserved. The marble logo is a trademark of Sony Ericsson Mobile Communications AB.  
 Sony is a trademark of Sony Corporation. Ericsson is a trademark of Telefonaktiebolaget LM Ericsson.

**m2m**<sup>™</sup>  
 Expanding Wireless Possibilities

Subject to change without prior notice.  
 LZT 123 9126 R1D

Expanding Wireless Possibilities



Siemens MC39i

www.siemens.com/fwm



**SIEMENS**  
Mobile

Accelerate wireless communication

Wireless Modules



Be inspired

**MC39i**

The Dual-Band module MC39i offers the maximum possible data transmission rate for GSM/GPRS. Its compact and extremely robust structure makes it suitable for both consumer electronics and industrial environment M2M applications. Some possibilities include:

- Mobile computing devices
- Security systems
- GPRS modems
- Smart phones
- Telemetry and Telematics systems

Build the future: the MC39i can be quickly integrated into your device free of complications. It is based on the proven platform of the MC35i, with which it is completely downward compatible.

For contact and more information please visit [www.siemens.com/fwm](http://www.siemens.com/fwm)



# MC39i – enjoy the maximum rate of data transmission in wireless high-speed communication

With GPRS class 10 the Dual-Band GSM/GPRS module MC39i provides the maximum data transmission rate with low power consumption. It enables data, voice, SMS and fax applications. Thanks to its flexible mounting concept, the module can be easily integrated into all kinds of host devices. Full compatibility to the Siemens MC35i allows to upgrade existing applications to GPRS class 10. We ensure full type approval according to R&TTE and GCF as well as approval from leading GSM network operators.



## Wireless Modules Benefits and hard facts

Original size

<p><b>General features:</b></p> <ul style="list-style-type: none"> <li>• Dual-Band EGSM900 and GSM1800</li> <li>• Compliant to GSM phase 2/2+</li> <li>• Output power:             <ul style="list-style-type: none"> <li>– Class 4 (2 W) for EGSM900</li> <li>– Class 1 (1 W) for GSM1800</li> </ul> </li> <li>• Control via AT commands</li> <li>• SIM application toolkit</li> <li>• Multiplex serial interface</li> <li>• Supply voltage range 3.3 ... 4.8 V</li> <li>• Power save mode</li> <li>• Power consumption:             <ul style="list-style-type: none"> <li>– Power down 50 µA</li> <li>– Sleep mode (registered DRX = 6) 3.0 mA</li> <li>– Speech mode (average) 300 mA</li> <li>– GPRS class 10 (average) 590 mA</li> </ul> </li> <li>• Dimensions: 54.5 x 36 x 3.6 mm</li> <li>• Weight: 9 g</li> <li>• Ambient temperature:             <ul style="list-style-type: none"> <li>– 20 °C ... +55 °C</li> </ul> </li> <li>• Automatic switch-off at – 25 °C and +70 °C</li> </ul> <p><b>Specifications for fax:</b></p> <ul style="list-style-type: none"> <li>• Group 3, class 1, 2</li> </ul>	<p><b>Specifications for data transfer:</b></p> <ul style="list-style-type: none"> <li>• GPRS class 10 (21.4 kbps uplink/85.6 kbps downlink or 42.8 kbps uplink/64.2 kbps downlink)</li> <li>• Full PBCCH support</li> <li>• MS class B</li> <li>• Coding scheme CS 1, 2, 3, 4</li> <li>• CSD up to 14.4 kbps</li> <li>• USSD</li> <li>• Non transparent mode</li> <li>• V.110</li> </ul> <p><b>Specifications for SMS:</b></p> <ul style="list-style-type: none"> <li>• Point-to-point MO and MT</li> <li>• SMS cell broadcast</li> <li>• Text and PDU mode</li> </ul> <p><b>Specifications for audio:</b></p> <ul style="list-style-type: none"> <li>• Half rate (HR)</li> <li>• Full rate (FR)</li> <li>• Enhanced full rate (EFR)             <ul style="list-style-type: none"> <li>– Echo cancellation</li> <li>– Noise reduction</li> </ul> </li> </ul> <p><b>Additional features:</b></p> <ul style="list-style-type: none"> <li>• Phone book</li> <li>• Multiparty call</li> <li>• Call diverting</li> </ul>	<ul style="list-style-type: none"> <li>• Real-time clock</li> <li>• Alarm management</li> <li>• Several ringing tones</li> <li>• DTMF</li> </ul> <p><b>Interfaces:</b></p> <ul style="list-style-type: none"> <li>• 40-pin ZIF connector:             <ul style="list-style-type: none"> <li>– Power supply</li> <li>– SIM 3 V</li> <li>– Serial interface with ITU-T V.24 protocol</li> <li>– 2 analog audio interfaces</li> </ul> </li> <li>• 50 Ω GSC RF connector</li> </ul> <p style="font-size: small; margin-top: 10px;">More about Wireless Modules at: <a href="http://www.siemens.com/wm">www.siemens.com/wm</a></p> <p style="font-size: small; margin-top: 10px;">Copyright 2003, Siemens AG Information and Communication Mobile Wireless Modules Haidenauplatz 1 81667 Munich, Germany</p> <p style="font-size: small; margin-top: 10px;">Subject to changes in technology and availability Order No.: A31001-W25-A219-X-7600 Printed in Germany</p>
---	---	--

Fastrax iTrax03/08



## iTrax03

### OEM GPS Receiver Module

- Very High Sensitivity
- Ultra Low Power Consumption
- Market Leading Programmability

Fastrax iTrax03 OEM GPS receiver modules enable the implementation of full-fledged positioning features into appliances faster and with less effort than ever before.

Offering industry-leading benefits in performance, size, power consumption, programmability and total cost of product, the iTrax03 receivers are ideally suited for both industrial tracking and navigation systems and battery-operated consumer products like sports accessories, handheld computers, asset tracking devices, vehicle navigation devices and mobile phones.

**Market Leading System Performance**  
Ultra-low, user configurable power management makes iTrax03 one of the lowest power consuming, complete 12-channel OEM GPS receivers on the market. Nevertheless, there are no compromises in performance. The iTrax03 receivers have a navigation sensitivity as low as -152dBm making them applicable even for extremely demanding applications and environments. The iTrax03 includes a full-fledged MMC-card interface which enables integrated PDA applications i.e. maps for navigation. A-GPS can be used to further improve TTFF and acquisition sensitivity.

**Cutting component costs**  
Space and costs are reduced due to the cutting-edge technology architecture in the iTrax03 receivers. The surface mount SMD design eliminates need for expensive and labour intensive system and RF connectors. Very few additional components are required. Utilizing the iTrax03 programmability cost of a host CPU can be saved. The

**iTRAX03 Key Features:**

- Tiny PCB form factor – 23mm x 23mm x 2.7mm
- Ultra-low power consumption – <math>35\text{mW}</math> @ 2.7V
- Very High Sensitivity –152dBm (Tracking)
- Basic A-GPS support
- iTALK and NMEA0183 protocols
- Kalman Navigation
- Supports remote software updates
- Extensive support for external sensors
- Versatile interface ports
- Accurate 1PPS timing output
- iTRAX03/16 – 16MBit Flash Memory  
iSUITE03 SDK Software Development Kits  
Datalogger, up to 70,000 datapoints
- iTRAX03/8 – 8MBit Flash Memory  
NMEA Engine

dedicated hardware search engine ensures fast TTFF thus no back-up battery is required. These benefits can easily be converted to smaller component costs and smaller design – crucial parameters for many projects.

**iTRAX03/16 – Versatile Programmability**  
The iTrax03/16 features 16 MBit Flash memory which allows versatile programmability with iSuite03 SDK. It also allows permanent operation parameter changes via NMEA or iTalk and data logging as a standard feature. Application costs are reduced significantly when no external processor is required and the iTrax03 is used as a host controller. With fewer components, cost and application size are reduced.

**iTRAX03/8 – cost efficient performance**  
In applications where the industry standard NMEA0183 protocol is sufficient and programmability is unnecessary, the iTrax03/8 with 8MBit Flash memory, is a cost efficient and high performance alternative.

**Quick Start with Easy-To-Deploy Solution**  
The addition of an antenna and power supply is all that is required to make the iTRAX03 operational. The Fastrax Engineering Services team can provide antenna design application notes to aid in further refinement of the antenna design for specific applications.





iTrax03

## OEM GPS Receiver Module

### Specifications

<b>General</b>	L1 frequency, C/A code (GPS) 12 independent tracking channels Separate search & acquisition engine	<b>IO Ports:</b>	Dual Asynchronous data ports 28-pin GPIO (shared Functionally) 2 x SPI Interface Dual Pulse Measurement inputs 1 PPS Output 2 x Pulse Measurement Times 2 x Capture Times 2 x Checkpoints MMC/Waste (optional)
<b>Update rate:</b>	1 Hz or user configurable	<b>Protocol:</b>	NMEA0183 V1.0 Proprietary TRAK binary protocol
<b>Accuracy:</b>	Position: 3m (CEP), 6m 2DRMS Velocity: 0.2 m/s (0.7%) Time: 20 ns RMS (static mode)	<b>Processor:</b>	Proprietary, 32MIPS integrated 16.02-bit DSP core BIOS file programming under Pre-emptive Real Time Operating System Control (RTOS/SP-RTOS)
<b>Reacquisition:</b>	100ms typical (signal reacquisition)	<b>Flash Memory:</b>	TRAK03A: 16 MBits Flash TRAK03B: 8 MBits Flash
<b>TTFF:</b>	Out of the box start 40 s typical Cold Start: 26 s Hot Start: 8 s Quick Start: 3 s	<b>Dimensions:</b>	23 mm x 23 mm x 2.7 mm (including RF shield)
<b>Dynamics:</b>	Acceleration: 4 G Jerk: 4 m/s <sup>3</sup>	<b>Weight:</b>	3 g
<b>Sensitivity:</b>	-152dBm (peak)	<b>Connectivity:</b>	37 SMD connectors pads under the module
<b>Operating Voltage:</b>	2.7V...3.3V (ready regulated)	<b>Software Features:</b>	Helix™ Navigation Reprogramming on the fly D-GPS Supporting RTCM Standard Advanced Multipath Mitigation Advanced Cross-Constellation Mitigation A-GPS Support WAAS / EGNOS Support
<b>Operating Temp:</b>	-40C...+85 C		
<b>Antenna Supply:</b>	Same as board supply		
<b>Antenna:</b>	External passive or active		
<b>Power Drain:</b>	95mW @ 2.7V (Dynamic Mode) 20mW @ 2.7V (Idle Mode) 50mW @ 2.7V (Sleep Mode) (Active antenna power not included)		

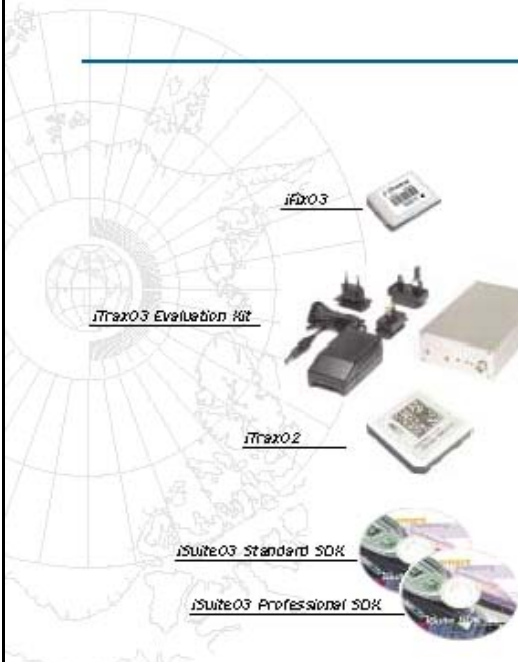

### Other Fastrax GPS products

The iTrax03 Family includes iFix03 OEM GPS Measurement Front End, iSuite03 Standard SDK, iSuite03 Professional SDK, iTrax03 Evaluation Kit and iTrax03 Development Board. The iTrax03 Evaluation Kit includes an universal power supply, two serial cables, an active antenna, a user's manual and a CD with documentation and the GPS WorkBench PC software. The iTrax03 Development Board allows customers to develop custom demanding applications utilizing the versatile programmability and extensive connections available on the iTrax03 products.

iTrax02 family of products includes iTrax02/4, iTrax04/8, iTracker02, iPatch02 and iTrax02 Evaluation Kit.

For programming the iTrax03/16 Fastrax offers iSuite03 Standard SDK (software development kit). In addition to the software the iSuite03 Standard SDK includes three days of hands on training and e-mail support during development. The iSuite03 Professional SDK gives programmers access to extensive source code libraries enabling development of application using A-GPS, WAAS / EGNOS, RTK, external sensors, MMC interface, LCD drivers and other communication drivers in addition to Production Support Toolkit.

Separate product descriptions can be found at [www.fastrax.fi](http://www.fastrax.fi)

J. Lehtinen 12/2009

Motorola iO270

# iO270 Embedded module

Delivering seamless mobility to the M2M world.



The Motorola iO270 embedded module easily delivers pass through features such as Digital Cellular Voice, Packet Data, Digital Dispatch and on board GPS to a variety of OEM products.

Commercial, Industrial and Consumer Electronic devices can now benefit from voice and/or data technologies enhancing their usual capabilities. OEMs can continue to add depth to existing products or expand their product offering through the value added features that comes standard with the iO270.

Track the location of your assets every minute of the day. The integrated GPS feature is network independent; capturing coordinates in areas where no cellular coverage is available. In addition, the iO270's dual antenna ports permits the transmission of location coordinates even with other features are being utilized.

Just think of the world of possibilities.

Machine-to-machine, machine-to-mobile and mobile-to-machine communications have never been easier.



# MOTO2MOTO



The iO270 offers feature capabilities from the most versatile digital communications services available.

- Engineering
- Mobile Computing & Consumer Electronics
- Manufacturing and Healthcare
- Security and Tracking
- Telemetry and Utilities

V1



# iO270 module

## Product Specifications

**PRODUCT FEATURES**

- Digital Cellular Voice
- Push-To-Talk Digital Dispatch
- Packet Data Transfer
- Network Independent A-GPS
- Fax Capabilities

**Physical**

- Size: 47mm x 47mm
- Weight: 16.6 gram
- 70 Pin Connector

**Environmental**

- Operating temperature: -20°C +60°C 5°C
- Storage temperature: -40°C +8
- Shock: MIL-STD-810E Method 516.4 Proc. 0Hz, 4G Peak
- Vibration : 2X-EIA Sine, 20-200 4G Peak

**PHYSICAL INTERFACES**

**Electrical Frequency**

- TX 806-825 MHz
- RX 851-870 MHz
- TX 896-902 MHz
- RX 935-941 MHz
- 900 MHz Control Channel + Dispatch Support (Special Req)

**SIM Card**

- 64K SIM
- 3.0V

**PERFORMANCE**

**Operating Voltage**

- Voltage: 3.2V - 4.2V

**Current Consumption**

- 3A Tx max Peak,
- 1A average TX Slot
- 300mA Average at TX 1.6
- 12mA standby (sleep mode)

**TX Power**

- 0.6W 800 MHz
- 0.6W 900 MHz

**Data Interfaces**

- Direct Access (RS232)
- UART1 Primary
- UART2 Secondary
- USB
- SLIP (via Direct Access)
- PPP (via Direct Access)
- AT commands
- AT over UDP

**DATA BEARERS**

**IDEN**

- Dispatch 1.6
- Interconnect 1.3
- Packet Data
- Circuit data

**SMS**

- MO / MT PDU modes

**LED STATUS INDICATIONS**

- Registration
- In Service
- In Use
- No Service

**AT COMMAND SET**

- GSM 07.07 (pass-through)
- GSM 07.05 (pass-through)
- Motorola proprietary commands

**REGULATORY AND APPROVALS**

- FCC
- Industrial Canada
- QS 9000 Manufacturing

**ACCESSORIES**

- Developer's Kit



**CONTACT**

Wayne Clarke  
 Domestic – Business & Industrial Applications  
 954-723-3532  
 w.clarke@motorola.com

Kirk Meyer  
 International - Business & Industrial Applications  
 954-723-8503  
 Kirk.meyer@motorola.com

Imran Mohammed  
 Domestic – Consumer Electronics  
 954-723-8109  
 Imran.mohammed@motorola.com

Motorola Customer/Integrator Support  
 800-282-0533  
 m2mdeveloper@custhelp.com

[www.motorola.com/iDEN](http://www.motorola.com/iDEN)



MOTOROLA and the Stylized M Logo are registered in the U.S. Patent and Trademark Office. All other product or service names are the property of their respective owners. © Motorola, Inc. 2006.

Telit GE863-GPS



**GE863-GPS**

Embedded





SiRF<sup>®</sup>  
Powered



BGA Package



20-channel  
GPS receiver



High Sensitivity



Quad Band



RoHS Compliant



Embedded  
TCP/IP Stack



GPRS Class 10



PYTHON\*  
Script Interpreter



Embedded FTP  
and SMTP Client



Extended  
Temperature Range



Extended  
RF Sensitivity

The new GE863-GPS is the smallest combined GPRS/GPS module on the market! It combines Telit's proven GSM/GPRS core technology with the latest SiRFstarIII™ high sensitivity Single Chip GPS receiver.

The unique Ball-Grid-Array (BGA) package enables a very low profile and small product size to design extremely compact applications using location technology. Since all connectors are eliminated, the solution cost is significantly reduced compared to conventional mounting concepts.

With its ultra low profile design and extended temperature range, the Telit GE863-GPS is the perfect module for all compact, high volume telematics devices, Fleet Management, Tracking and Security solutions.

Additional features like Jamming Detection, integrated TCP/IP protocol stack, Easy Scan functionality and the direct support of an embedded camera offer extended functionality to the application at no additional cost.

As a part of Telit's corporate policy of environmental protection, all new Telit products comply to the RoHS (Restriction of Hazardous Substances) directive of the European Union. [EU Directive 2002/95/EG].

**Product Features**

- Quad-band EGSM 850 / 900 / 1800 / 1900 MHz
- Output Power
  - Class 4 (2W) @ 850 / 900 MHz
  - Class 1 (1W) @ 1800 / 1900 MHz
- Control via AT commands according to GSM 07.05, 07.07 and proprietary Telit
- Supply Voltage Range: 3,4 - 4,2 V DC (3,8 V DC recommended)
- Power Consumption (typical values)
  - power off: < 26 uA
  - Idle (registered, power saving): < 4 mA
  - Dedicated mode (max): 270 mA
  - GPRS cl.10 (max): 500 mA
- Serial Port Multiplexer GSM 7.10
- SIM Access Profile
- GPS Power Consumption:
  - Stand-by current: 1 mA
  - Operating current: 70 mA, (including 20 mA for the antenna LNA)
- GSM Sensitivity:
  - 107 dBm (typ.) @ 850 / 900 MHz
  - 106 dBm (typ.) @ 1800 / 1900 MHz
- Dimensions: 41.4 x 31.4 x 3.6 mm
- Weight: 9 gr.
- Extended Temp. range: -30° / +80° C
- RoHS compliant

**Making machines talk.**

# GE863-GPS

Embedded

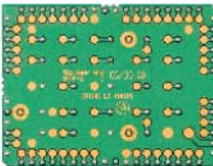

original size

### GPS receiver

- High sensitivity for indoor reception, up to -159 dBm
- Extremely fast TTFF's at low signal levels
- Hot starts < 2 seconds
- 200,000+ effective correlators
- Supports 20-Channel GPS
- GPS NMEA 0183 output format

### Interfaces

- 18 I/O ports max.
- Analog Audio (balanced and unbalanced)
- 1 A/D plus 1 D/A converters
- Buzzer output
- Camera direct support mode on I/O ports
- ITU-T V24 Serial Link through CMOS UART: Baud rate from 300 to 115 200 bps Autobauding from 2.400 to 57 600 bps
- 18 General Purpose I/O Ports
- SPI-Bus
- IIC-Bus

### Audio

- Telephony, Emergency
- Half rate, Full rate, Enhanced Full rate and Adaptive Multi Rate voice codecs (HR, FR, EFR, AMR)
- Superior echo cancellation & NoiseReduction
- Handset & Hands-free operations
- DTMF

### Approvals

- Fully type approved according to R&TTE
- CE, GCF, FCC, PCTRB, IC

### SMS

- Point-to-Point mobile originated and mobile terminated SMS,
- Concatenated SMS supported
- SMS Cell Broadcast
- Circuit Switched Data
- Asynchronous Transparent Circuit Switched Data (CSD) up to 14,4 kbps
- Asynchronous Non-transparent CSD up to 9,6 kbps

### GPRS Data

- GPRS class 10
- Mobile station class B
- Coding Scheme 1 to 4
- PBCCH support

### Fax

- Group 3, Class 1

### GSM Supplementary

- Call Forwarding
- Call Barring
- Call Waiting & Call Hold
- Advice of Charge
- Calling Line Identification Presentation (CLIP)
- Calling Line Identification Restriction (CLIR)
- Unstructured supplementary Services Mobile Originated Data (USSD)
- Closed User Group

### Additional Features

- SIM Phonebook
- Fixed Dialling Number (FDN)
- Real Time Clock
- Alarm Management
- Battery Management
- Network LED support
- IRA character set
- Jamming Detection & Report
- Embedded TCP/IP stack, including SMTP and FTP protocol
- Python\* script interpreter allows driving the module »internally« implementing the application code directly in the Python\* language. Approx. 3 MB of NV Memory for the user scripts and 1.5 MB RAM for the Python\* engine usage.



### Telit's EASY® features

- »EASY CAMERA« it provides the capability of a direct support of a VGA colour camera
- »EASY SCAN« automatic scan over GSM frequencies (also without SIM card)

### Order-No.

GE863-GPS 3 990 250 660



Telit Communications S.p.A.  
Via Stazione di Prosecco, 5/B  
I-34010 Sgonico (Trieste), Italy  
Tel +39 040 4192 200  
Fax +39 040 4192 383  
E-Mail: modules@telit.com  
www.telit.com

Copyright © 2004, Telit Communications S.p.A. - Subject to changes in technology, design and availability.  
\* Copyright © 1995-2001 by Stichting Mathematisch Centrum, Amsterdam, The Netherlands; All Rights Reserved.  
Copyright © 2001, 2002, 2003, 2004 Python Software Foundation; All Rights Reserved.  
All Rights Reserved are reserved in Python.



Sierra Wireless MC8775

**MC8775 PCI EXPRESS MINI CARDS**  
**POWERFUL, COST EFFECTIVE, STANDARDS-BASED HSDPA ENGINES**

**AIRCARD ENABLED™ SOLUTIONS**

The MC8775 PCI Express Mini Card is a powerful, cost effective solution that easily integrates into laptops and other host devices offering complete wireless data solutions over HSDPA-capable UMTS networks. Embedded right into computing devices for best possible performance, users will be 'AirCard Enabled™', and receive the same high-performance wireless wide area connectivity customers have come to expect from Sierra Wireless' award-winning AirCard products. The MC8775 PCI Express Mini Card will truly change the way people access e-mail, the Internet and corporate applications through their computing devices. With tri-band HSDPA, the MC8775 is designed for global use and operates on the 850, 1900, and 2100 MHz WCDMA bands.

**POWERFUL HSDPA ENGINES**

The MC8775 PCI Express Mini Card is the latest in a series of successful Sierra Wireless GSM products. Built using the latest HSDPA technology, the MC8775 Mini Card is a complete 3.6 Mbps HSDPA wireless solution, offering data and SMS functionality.

- Typical download rates of 500 to 800kbps, peak speeds up to 3.6Mbps\*
- Uses MSM6280™ chipset from QUALCOMM
- Supports tri-band UMTS (HSDPA): 850, 1900, and 2100 MHz
- Supports quadband EDGE/GPRS/GSM: 850/900/1800/1900 MHz
- Support third generation (3G) digital cellular standards
- Enable rapid development of exceptional high-speed data products
- Comprehensive WHOL-certified USB software driver architecture

Standalone carrier certification, and Infrastructure interoperability lab testing for the MC8775 will allow customers to efficiently integrate, certify, and achieve the best time-to-market possible for their products.

**PCI EXPRESS MINI CARD STANDARD**

Based on the PCI Express Mini Card specification, the MC8775 offers premium functionality and performance. Sierra Wireless' flexible Command and Status (CnS) interface and key software applications support compelling data products. Extensive software, applications and tools, installation and activation wizards, and essential hardware drivers simplify the certification and commercialization process. Measuring 51 x 30 x 4.5 mm and weighing in less than 12g, the MC8775 also complies with new European Union directives on RoHS (Restrictions on Hazardous Substances).

\* Subject to network conditions, see service provider for details

**SUPERIOR SUPPORT TO HELP WITH INTEGRATION REQUIREMENTS**

Sierra Wireless has extensive experience working with customers to develop and bring GSM data solutions to market on a timely basis. Backed by a leading development and support team, customers can depend on Sierra Wireless to provide comprehensive software interface, development and integration services and a full suite of complementary software drivers to expedite product development cycles. Look at Sierra Wireless as a reliable extension of your development team to efficiently design, develop, certify, and launch exceptional wireless data products.

Sierra Wireless is your only source for AirCard Enabled wireless data solutions.



- **POWERFUL, COST EFFECTIVE HSDPA ENGINE THAT INTEGRATES EASILY INTO DEVICES**
- **BEST IN CLASS TECHNICAL AND INTEGRATION SUPPORT AND PROFESSIONAL SERVICES ACCELERATE END PRODUCT TIME-TO-MARKET**
- **COMPREHENSIVE SOFTWARE OFFERING, DEVELOPMENT KIT AND APPLICATIONS SIMPLIFIES DEVELOPMENT PROCESS**
- **USES LATEST QUALCOMM TECHNOLOGY**



PCI Express Mini Card Standard

Superior Integration Support

Fastest Time to Market

AirCard Enabled™







**MC8775 PCI EXPRESS MINI CARD**

**TECHNICAL SPECIFICATIONS**

**PACKAGE:**  
 Length: 51 mm  
 Width: 30 mm  
 Thickness: 4.5 mm  
 Weight: under 12 g

**POWER:**  
 Input Voltage Range: 3.0 ~ 3.6V  
 Low talk current  
 Low stand-by current

**ANTENNA CONNECTOR:**  
 50 Ohm compatible  
 U, FL RF connector

**NETWORKS:**  
 850/1900/2100MHz WCDMA  
 Power class 3 (+24dBm)  
 850/900MHz GSM/GPRS/EDGE  
 GSM Power class 4/EDGE E2  
 1800/1900 MHz GSM/GPRS/EDGE  
 GSM Power Class 1/EDGE E2

**HOST INTERFACE:**  
 52-Pin Edge Connector  
 Pinout supports PCI-Express Mini Card Specification Rev 1.1  
 USB 2.0  
 Software configurable LED control  
 U-SIM

**ENVIRONMENTAL:**  
 Operating Temperature: -20 to +60° C  
 Storage Temperature: -30 to +85° C

**ADDITIONAL FUNCTIONALITY:**  
 AT command interface  
 Software Development Kit (SDK) including Application Program Interface (API)  
 RoHS compliant

**DATA SERVICES:**  
 850/1900/2100 MHz WCDMA  
 Forward link up to 3.8Mbps  
 Reverse link up to 384Kbps

850/900/1800/1900 MHz GSM/GPRS/EDGE  
 Forward link up to 216 Kbps  
 Reverse link up to 108 kbps

**FOR MORE INFORMATION**  
**North America and Asia**  
 Tel: +1 604 232 1488  
 Fax: +1 604 231 1109  
**Europe**  
 Tel: +44 20 8 622 3015  
 Fax: +44 20 8 622 3206

E-mail: [sales@sierrawireless.com](mailto:sales@sierrawireless.com)  
 Web site: [www.sierrawireless.com](http://www.sierrawireless.com)

Sierra Wireless, the Sierra Wireless logo, Watcher and the red wave design are trademarks of Sierra Wireless. Heart of the Wireless Machine and AirCard are registered trademarks of Sierra Wireless. Other registered trademarks that appear on this package are the property of the respective owners.  
 © 2006 Sierra Wireless, Inc.  
 P/N 2150107 rev 1.0

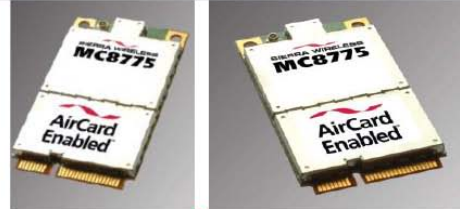

**SIERRA WIRELESS, THE LEADER IN WIRELESS WIDE AREA MOBILE COMPUTING**

Sierra Wireless is a recognized industry leader in developing wireless data products and enabling software for portable and industrial applications. Sierra Wireless's products include:

- AirCard line of PC Cards
- Line of 3G PCI Express Mini Cards for both CDMA 1xEV-DO, 1xEV-DO Rev A, and HSDPA technology tracks
- MP rugged wireless modem line for EDGE/GSM/GPRS and CDMA 1X networks
- Proprietary embedded module series for CDMA 1X and CDMA 1xEV-DO networks
- Software Development Kits (SDKs)

Now Sierra Wireless enhances your wireless access choices with high-performance broadband wireless products to meet your worldwide needs.



**SIERRA WIRELESS**  
**MC8775 PCI**  
**EXPRESS MINI CARDS**

**POWERFUL,**  
**COST EFFECTIVE,**  
**STANDARDS-BASED**  
**HSDPA ENGINES**

Sierra Wireless MC5720

**MC5720 PCI EXPRESS MINI CARD**  
**A POWERFUL, COST EFFECTIVE, STANDARDS-BASED 1xEV-DO ENGINE**

**AIRCARD ENABLED™ SOLUTIONS**

The MC5720 PCI Express Mini Card is a powerful, cost effective solution that easily integrates into laptops and other host devices offering a complete wireless data solution over CDMA 1xEV-DO networks. Embedded right into computing devices for best possible performance, users will be "AirCard Enabled™" and receive the same high-performance wireless wide area connectivity customers have come to expect from Sierra Wireless' award-winning AirCard products. Now available, the MC5720 PCI Express Mini Card will truly change the way people access e-mail, the Internet and corporate applications through their computing device.

**A POWERFUL 1xEV-DO ENGINE**

The MC5720 PCI Express Mini Card is the latest in a series of successful Sierra Wireless CDMA products. Built using the latest CDMA 1xEV-DO technology, the MC5720 Mini Card is a complete 3G-enabled wireless solution, offering data and SMS functionality.

- Typical download rates of 400-700kbps, peak speeds up to 2.4Mbps
- Uses MSM6500™ chipset from QUALCOMM
- Dual band and backwards compatible to IS-2000 (1XRTT) and IS-95 networks
- Supports third generation (3G) digital cellular standards
- Supports latest Zero IF-based technology
- Enables rapid development of exceptional high-speed data products
- Comprehensive WHOL-certified USB software driver architecture

The MC5720 PCI Express Mini Card has standalone carrier certification, and has completed the CDG infrastructure interoperability lab testing so customers can efficiently integrate, certify, and achieve the best time-to-market possible for their products.

**PCI EXPRESS MINICARD STANDARD**

Based on the PCI Express Mini Card specification, the MC5720 offers premium functionality and performance. Sierra Wireless' flexible Command and Status (CnS) interface and key software applications support compelling data products. Extensive software, applications and tools, installation and activation wizards, JOTA clients, mobile IP support and essential hardware drivers simplify the certification and commercialization process. Measuring 51 x 30 x 4.5 mm and weighing in less than 12g, the MC5720 also complies with new European Union directives on RoHS (Restrictions on Hazardous Substances).

The MC5720 is Sierra Wireless' third product for EV-DO networks, building on nearly two years of product development and refinement since the launch of the AirCard 590 EVDO wireless wide area PC card in 2003.

**SUPERIOR SUPPORT TO HELP WITH INTEGRATION REQUIREMENTS**

Sierra Wireless has extensive experience working with customers to develop and bring CDMA 1xEV-DO data solutions to market on a timely basis. Backed by a leading 1xEV-DO development and support team, customers can depend on Sierra Wireless to provide comprehensive software interface, development and integration services and a full suite of complementary software drivers to expedite product development cycles. Look at Sierra Wireless as an extension of your development team to efficiently design, develop, certify, and launch exceptional wireless data products.

Sierra Wireless is your only source for AirCard Enabled wireless data solutions.



- **A POWERFUL, COST EFFECTIVE 1xEV-DO ENGINE THAT INTEGRATES EASILY INTO DEVICES**
- **BEST IN CLASS TECHNICAL AND INTEGRATION SUPPORT AND PROFESSIONAL SERVICES ACCELERATE END PRODUCT TIME-TO-MARKET**
- **COMPREHENSIVE SOFTWARE OFFERING, DEVELOPMENT KIT AND APPLICATIONS SIMPLIFIES DEVELOPMENT PROCESS**
- **USES LATEST QUALCOMM 1xEV-DO TECHNOLOGY**

EMPOWERING NOW

PCI Express Mini Card Standard

Superior Integration Support

Fastest Time to Market

AirCard Enabled™



EMPOWERING NOW

**MC5720 PCI EXPRESS MINI CARD**

**TECHNICAL SPECIFICATIONS**

**PACKAGE:**

Length: 51 mm  
Width: 30 mm  
Thickness: 4.5 mm  
Weight: under 12 g

**POWER:**

Battery or 3.0 – 3.6V power supply  
Low talk current  
Low stand-by current

**ANTENNA CONNECTOR:**

50 Ohm compatible  
U, FL RF connectors

**FREQUENCY BANDS:**

Dual Band  
800MHz North American Cellular band  
1900MHz North American PCS band  
Supports RX diversity in both 800MHz and 1900 MHz bands  
GPS Band

**HOST INTERFACE:**

52-Pin Edge Connector  
Pinout supports PCI-Express Mini Card Specification Rev 1.1  
USB 2.0  
Software configurable LED control  
R-UIM

**ENVIRONMENTAL:**

Operating Temperature: -30 to 60° Celsius  
Storage Temperature: -40 to 85° Celsius

**ADDITIONAL FUNCTIONALITY:**

AT command Interface  
Software Development Kit (SDK) including Application Program Interface (API)  
RoHS compliant

**CDMA STANDARDS**

IS-856 (CDMA 1xEV-DO)  
IS-2000 (CDMA 1xRTT)  
IS-95 A/B  
IS-707-A Data  
IS-637-A SMS  
IS-683-A Service Provisioning  
IS-683-B (partial)  
Support for gpsOne™

**DATA SERVICES:**

CDMA 1xEV-DO (IS-856)  
Forward link up to 2.4Mbps  
Reverse link 153.6 Kbps  
CDMA 1xRTT (IS-2000)  
Forward and reverse link speeds up to 153.6Kbps

**FOR MORE INFORMATION**

North America  
Tel: +1 604 232 1488  
Fax: +1 604 231 1109

E-mail: [sales@sierrawireless.com](mailto:sales@sierrawireless.com)  
Web site: [www.sierrawireless.com](http://www.sierrawireless.com)

Sierra Wireless, the Sierra Wireless logo, Watcher and the red wave design are trademarks of Sierra Wireless. Heart of the Wireless Machine and AirCard are registered trademarks of Sierra Wireless. Other registered trademarks that appear on this package are the property of the respective owners.  
© 2005 Sierra Wireless, Inc.  
PIN 2150093 rev 1.0



**SIERRA WIRELESS, THE LEADER IN WIRELESS DATA COMMUNICATIONS HARDWARE AND SOFTWARE PRODUCTS**

Sierra Wireless is a recognized industry leader in developing wireless data products and enabling software for

portable and industrial applications. Sierra Wireless's products include

- AirCard line of PC Cards
- Line of PCI Express Mini Cards
- MP rugged wireless modem line for EDGE/GSM/GPRS and CDMA 1X networks
- Embedded module series for CDMA 1X and CDMA 1xEV-DO networks
- Software Development Kits (SDKs)

Now Sierra Wireless enhances your wireless access choices with high-performance broadband wireless products to meet your worldwide needs.



**SIERRA WIRELESS MC5720 PCI EXPRESS MINI CARD**

**A POWERFUL, COST EFFECTIVE, STANDARDS-BASED 1xEV-DO ENGINE**



# Appendix F - ZEUS Modem details

## ZEUS Modem-1

The following photos show the ZEUS Modem-1 with Fastrax GPS receiver and three possible options for wireless modem.

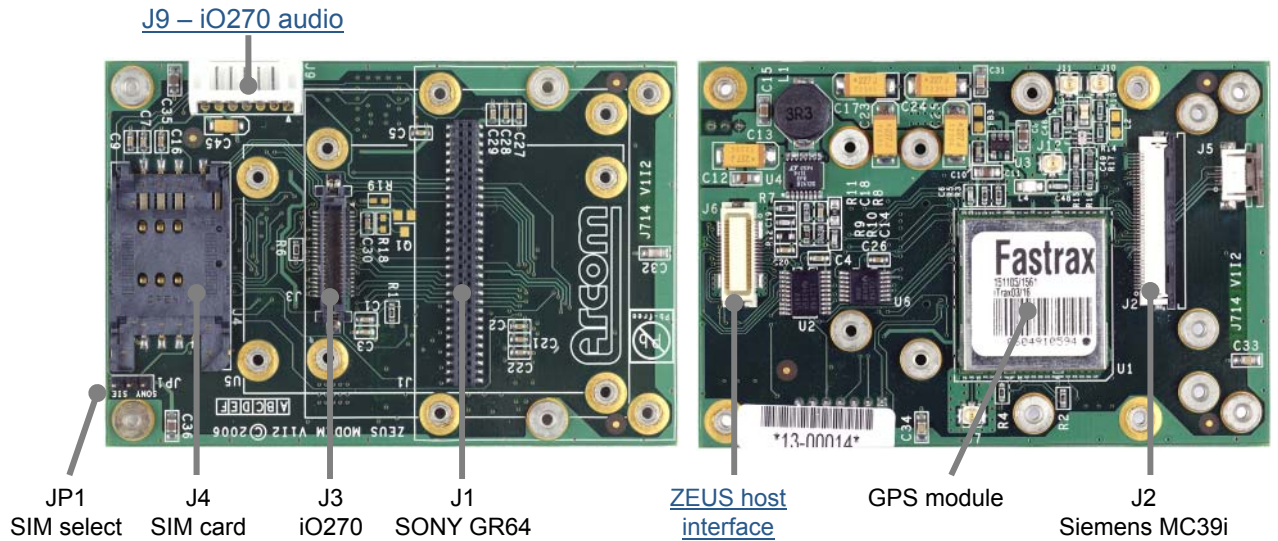

## ZEUS Modem-2

The following photos show the ZEUS Modem-2 with Telit option for wireless modem.

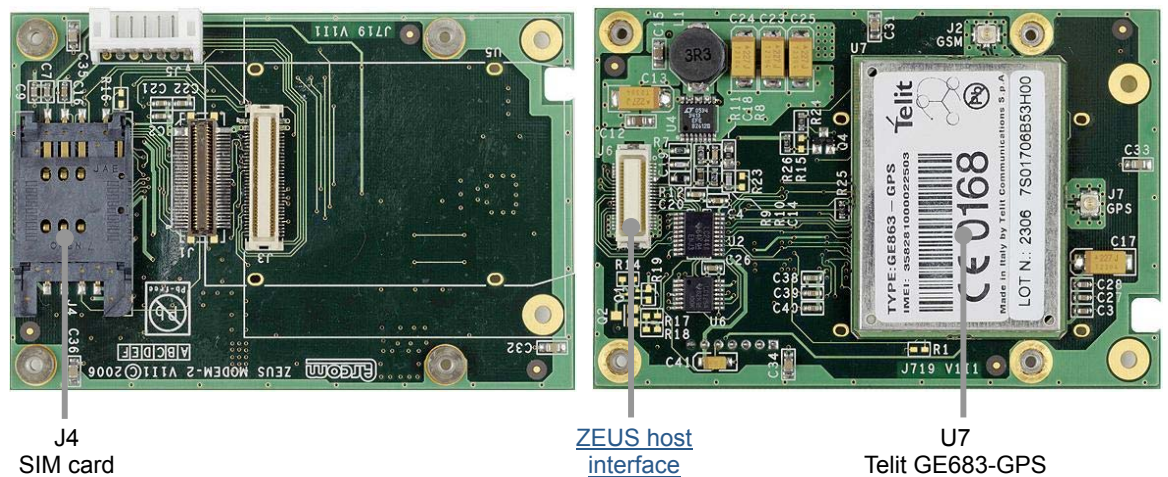

*ZEUS Modem-3*

The following photos show the ZEUS Modem-3 with Fastrax GPS receiver and several possible options for Sierra Wireless embedded modules.

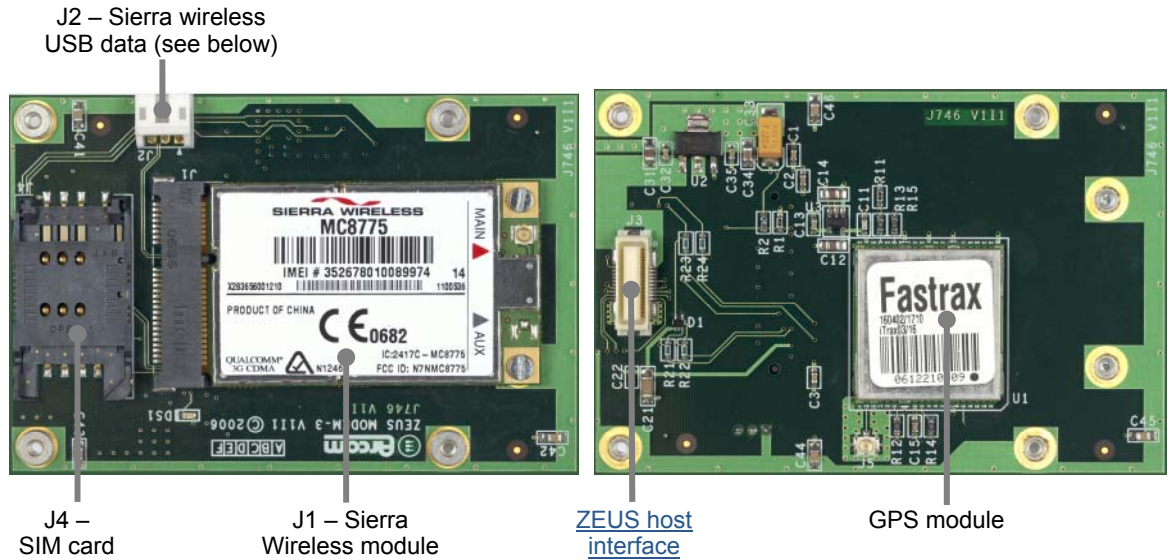

*J2 –Sierra wireless USB data connector*

Connector: NELTRON 2417RJ-3-F4, 3-way 2mm header

Mating connector: JST PHR-3, 3-way 2mm housing, female

Mating crimps: JST SPH-002T-P0.5S

Pin	Signal name
1	SHIELD
2	DATA-
3	DATA+

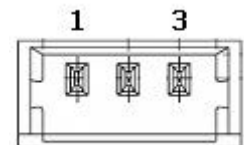

*ZEUS Modem connector details*

*ZEUS host interface*

Module connector: Hirose DF17(3.0)-40DS-0.5V(51), 40-way, 0.5mm pitch socket

Host connector: Hirose DF17(4.0)-40DP-0.5V(57), 40-way, 0.5mm pitch header

Pin	Signal name	Pin	Signal name
1	VCC_MODEM	2	VCC_MODEM
3	VCC_MODEM	4	VCC_MODEM
5	VCC_MODEM	6	VCC_MODEM
7	VCC_MODEM	8	VCC_MODEM
9	VCC_MODEM	10	VCC_MODEM
11	VCC_MODEM	12	GSM_STS
13	GSM_FFTXD <sup>1</sup>	14	GSM_FFRXD <sup>1</sup>
15	GSM_FFDTR# <sup>1</sup>	16	GSM_FFDSR# <sup>1</sup>
17	GSM_FFRTS# <sup>1</sup>	18	GSM_FFRI# <sup>1</sup>
19	GSM_ON	20	GSM_FFDCD# <sup>1</sup>
21	PTT	22	GSM_FFCTS# <sup>1</sup>
23	GPS_PSUON	24	GPS_BOOT
25	+3V3	26	+3V3
27	GPS_ON	28	GPS_PPS
29	GPS_STDTXD	30	GPS_STDRXD
31	GND	32	GND
33	GND	34	GND
35	GND	36	GND
37	GND	38	GND
39	GND	40	GND

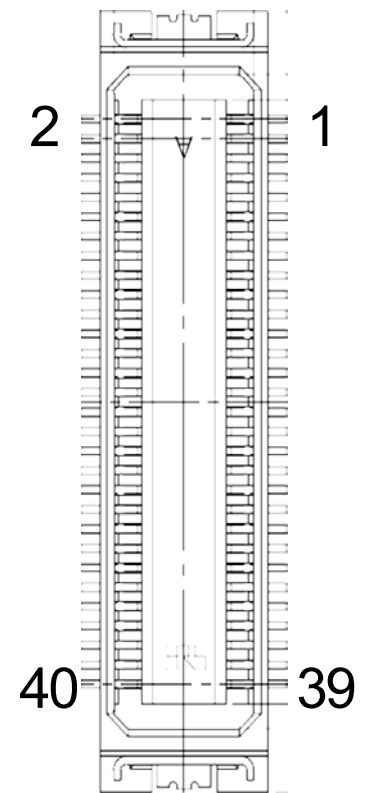

Note 1: Not used on Zeus Modem-3.

The following table shows the functions of control/status pins on the host interface:

EXP1_GPIO	Signal name	Dir	Active	Function
7	PTT	Output	High	Push To Talk. See note 1
8	GSM_ON	Input	See note 2	Modem enable
9	GSM_STS	Output	High	Modem ON/OFF status
10	GPS_ON	Input	High	GPS module enable
11	GPS_PSUON	Input	High	Not Used (PU keeps it at logic '1')
12	GPS_BOOT	Input	NA	Not Used (PU keeps it at logic '1')
13	GPS_PPS	Output	NA	GPS Pulse Per Second



Note 1: Only available with iDEN modules.

Note 2: Please see the datasheet of the particular module used. GSM\_ON is inverted when used with iDEN modules (GSM\_ON='0' – iDEN module is on).

*J9 –iO270 audio/PTT connector*

Connector: NELTRON 2417RJ-8-F4, 8-way 2mm header

Mating connector: JST PHR-8, 8-way 2mm housing, female

Mating crimps: JST SPH-002T-P0.5S

Pin	Signal name
1	SPKR-
2	SPKR+
3	3V_OPT
4	VCC
5	GND
6	PTT
7	MIC-
8	MIC+

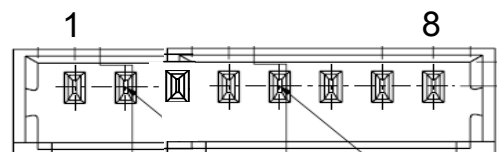

As viewed from the connector pins

## Appendix G - ZEUS-FPIF details

The ZEUS-FPIF allows easy connection between the ZEUS and a variety of TFT or STN LCD flat panel displays.

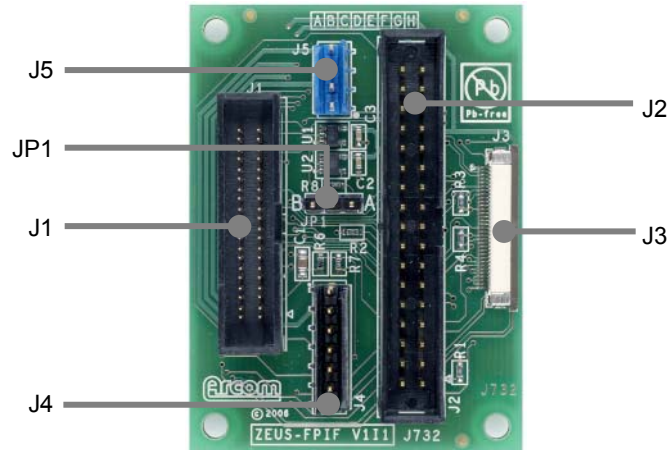

The connectors on the following pages are shown in the same orientation as the picture above.

Connector	Function
JP1	TFT clock delay selection
J1	ZEUS LCD cable connector
J2	Generic LCD connector
J3	Direct connection to a NEC NL3224BC35-20 5.5inch 320x240 TFT display
J4	Connects to backlight inverter
J5	STN bias voltages

### JP1 – TFT clock delay selection

It has been found that some TFT displays require a delay on the clock. If this is required fit the jumper in position A; if not, fit it in position B.

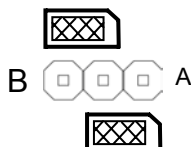



*J1 – ZEUS LCD cable connector*

Connector: Oupiin 3215-40GSB/SN, 40-way, 1.27mm (0.05") x 2.54mm (0.1") straight-boxed header

Mating connector: Oupiin 1203-40GB/SN (available from Eurotech Ltd on request)

Pin	Signal name	Pin	Signal name
1	BKLEN	2	BKLSAFE
3	PWM0	4	LCDSAFE
5	NEGBIAS	6	POSBIAS
7	GND	8	GND
9	FPD1	10	FPD0
11	FPD3	12	FPD2
13	FPD5	14	FPD4
15	GND	16	GND
17	FPD7	18	FPD6
19	FPD9	20	FPD8
21	FPD11	22	FPD10
23	GND	24	GND
25	FPD13	26	FPD12
27	FPD15	28	FPD14
29	NC	30	NC
31	GND	32	GND
33	BIAS (DE)	34	GND
35	FCLK (VSYNC)	36	GND
37	LCLK (HSYNC)	38	GND
39	PCLK (CLOCK)	40	GND

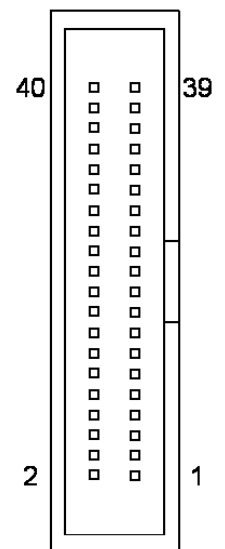

*J2 – Generic LCD connector*

Connector: Taicom TI34BHS, 34-way, 2.54mm (0.1") x 2.54mm (0.1") straight-boxed header

Mating connector: Fujitsu FCN-723-B034/2

Mating connector crimps: Fujitsu FCN-723J-AU/Q. (As it is possible to connect a crimp type connector to J2, a wide range of LCD displays can be connected with a custom cable)

Pin	Signal name	Pin	Signal name
1	GND	2	FPD0
3	FPD1	4	FPD2
5	GND	6	FPD3
7	FPD4	8	FPD5
9	FPD6	10	GND
11	FPD7	12	FPD8
13	FPD9	14	FPD10
15	GND	16	GND
17	FPD11	18	FPD12
19	FPD13	20	GND
21	FPD14	22	FPD15
23	GND	24	PCLK (CLOCK)
25	GND	26	LCDSAFE
27	LCDSAFE	28	LCLK (HSYNC)
29	FCLK (VSYNC)	30	GND
31	BKLSAFE	32	BIAS (DE)
33	NC	34	BKLEN

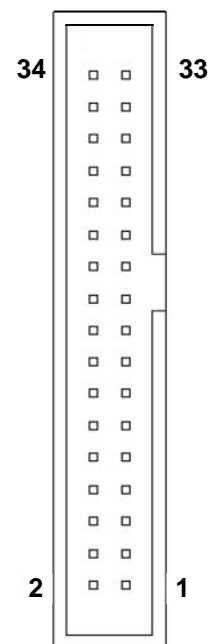

*J3 – Direct connection to a NEC NL3224BC35-20 5.5inch 320x240 TFT display*

Connector: Oupiin 2345-33TD2/SN

Mating cable: Eunsung 0.5x33x190xAx0.035x0.3x5x5x10x10

Pin	Signal name	Pin	Signal name
1	GND	18	FPD10
2	PCLK (CLOCK)	19	GND
3	LCLK (HSYNC)	20	GND
4	FCLK (VSYNC)	21	FPD0
5	GND	22	FPD1
6	GND	23	FPD2
7	FPD11	24	FPD3
8	FPD12	25	FPD4
9	FPD13	26	GND
10	FPD14	27	LBIAS
11	FPD15	28	LCDSAFE
12	GND	29	LCDSAFE
13	FPD5	30	GND
14	FPD6	31	GND
15	FPD7	32	GND
16	FPD8	33	GND
17	FPD9		

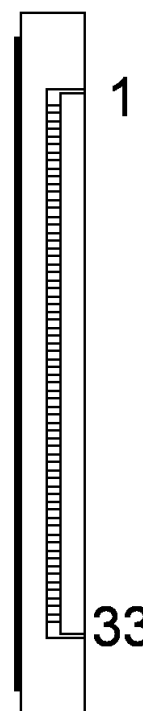

*J4 – Backlight inverter connector*

Connector: FCI 76384-407LF

Mating connector: FCI 65240-007LF

Mating connector crimps: FCI 76357-401LF

Pin	Signal name
1	BKLSAFE
2	BKLSAFE
3	GND
4	GND
5	BKLEN
6	BRT_CTRL
7	GND

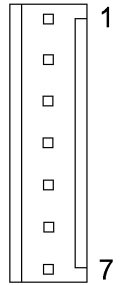

*J5 – STN Bias connector*

Connector: FCI 76384-404LF

Mating connector: FCI 65240-004LF

Mating connector crimps: FCI 76357-401LF

Pin	Signal name
1	POSBIAS
2	GND
3	GND
4	NEGBIAS

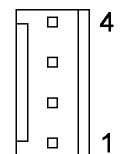

## Appendix H - ZEUS-FPIF-CRT details

The ZEUS-FPIF-CRT allows the ZEUS to drive a CRT Monitor or an analogue LCD flat panel. Sync on green and composite sync monitors are not supported.

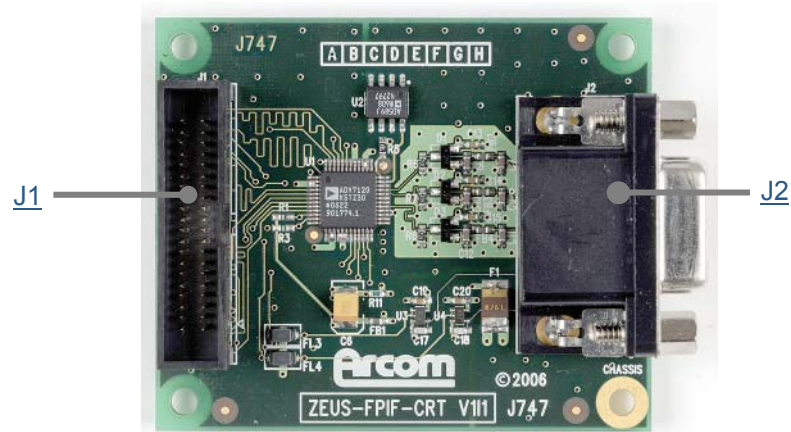

The connectors on the following pages are shown in the same orientation as the picture above, unless otherwise stated.

Connector	Function
J1	ZEUS LCD cable connector
J2	CRT connector

## J1 – ZEUS LCD cable connector

Connector: Oupiin 3215-40CSB/SN, 40-way, 1.27mm (0.05") x 2.54mm (0.1") straight-boxed header

Mating connector: Oupiin 1203-40GB/SN (available from Eurotech Ltd on request)

Pin	Signal name	Pin	Signal name
40	GND	39	CLOCK
38	GND	37	HSYNC
36	GND	35	VSYNC
34	GND	33	DE
32	GND	31	GND
30	NC	29	NC
28	FPD14	27	FPD15
26	FPD12	25	FPD13
24	GND	23	GND
22	FPD10	21	FPD11
20	FPD8	19	FPD9
18	FPD6	17	FPD7
16	GND	15	GND
14	FPD4	13	FPD5
12	FPD2	11	FPD3
10	FPD0	9	FPD1
8	GND	7	GND
6	NC	5	NC
4	NC	3	NC
2	BKLSAFE	1	NC

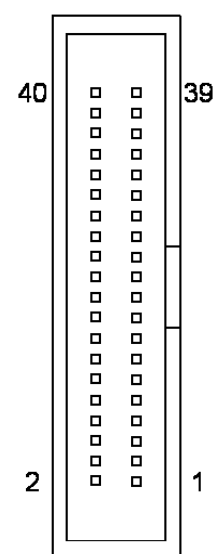

## J2 – CRT connector

Connector: Oupiin 7916-15FA/SN, 15-way, female, high density, right-angled D-Sub.

Pin	Signal name	Pin	Signal name	Pin	Signal name
1	RED	6	RED GND	11	NC
2	GREEN	7	GREEN GND	12	NC
3	BLUE	8	BLUE GND	13	HSYNC
4	NC	9	5V_VGASAFE	14	VSYNC
5	TTL GND	10	SYNC GND	15	NC

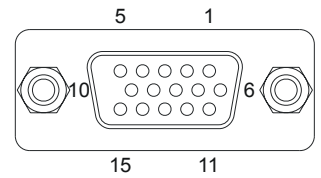

(As viewed from the connector pins)

## Appendix H - Acronyms and abbreviations

Amp	Amplifier
BTUART	Bluetooth Universal Asynchronous Receiver / Transmitter
CCCR	Core Clock Configuration Register
CODEC	Coder/Decoder
COM	Communication Port
CPLD	Complex Programmable Logic Device
CPU	Central Processing Unit (PXA270)
CMOS	Complementary Metal Oxide Semiconductor
DMA	Direct Memory Access
DUART	Dual Universal Asynchronous Receiver / Transmitter
EEPROM	Electrically Erasable and Programmable Read-Only Memory
EMC	Electromagnetic Compatibility
EPIC	Embedded Platform for Industrial Computing
EPROM	Erasable and Programmable Read-Only Memory
FFUART	Full Function Universal Asynchronous Receiver / Transmitter
FIFO	First-In First-Out
Flash	A non-volatile memory that is preserved even if the power is lost
FPIF	Flat Panel Interface
GPIO	General Purpose Input/Output
I <sup>2</sup> C	(=IIC) Intra Integrated Circuit bus
IEEE	Institute of Electrical and Electronics Engineers
IO	Input/Output
ISA	Industry Standard Architecture, Bus in the IBM-PC
JTAG	Joint Test Action Group of IEEE
LED	Light Emitting Diode
LCD	Liquid Crystal Display
LSB	Least Significant Bit
LVDS	Low Voltage Differential Signalling
MOSFET	Metal-Oxide Semiconductor Field-Effect Transistor
NA	Not Applicable
NC	No Connect
NU	Not Used
OS	Operating System
PC/104	Offers full architecture, hardware and software compatibility with the PC ISA bus, but in ultra-compact 96mm x 91mm (3.775" x 3.550") stackable modules
PCB	Printed Circuit Board
PoE	Power over Ethernet
PROM	Programmable Read-Only Memory
PWM	Pulse-Width Modulation
RAM	Random Access Memory
RTC	Real Time Clock
RX	Receive
SBC	Single Board Computer



SDIO	Secure Digital Input/Output
SDRAM	Synchronous Dynamic Random Access Memory
SRAM	Static Random Access Memory
STN	Super Twisted Nematic, technology of passive matrix liquid crystal
STUART	Standard Universal Asynchronous Receiver / Transmitter
SVGA	Super Video Graphics Adapter, display resolution 800 x 640 pixels
TFT	Thin Film Transistor, a type of LCD flat-panel display screen
TX	Transmit
UART	Universal Asynchronous Receiver / Transmitter
USB	Universal Serial Bus
VAC	Voltage Alternating Current
VDC	Voltage Direct Current
VGA	Video Graphics Adapter, display resolution 640 x 480 pixels
WDT	Watchdog Timer
ZEUS-ICE	ZEUS-Industrial Compact Enclosure

# Appendix I - RoHS-6 Compliance - Materials Declaration Form



## Confirmation of Environmental Compatibility for Supplied Products

Substance	Maximum concentration
Lead	0.1% by weight in homogeneous materials
Mercury	0.1% by weight in homogeneous materials
Hexavalent chromium	0.1% by weight in homogeneous materials
Polybrominated biphenyls (PBBs)	0.1% by weight in homogeneous materials
Polybrominated diphenyl ethers (PBDEs)	0.1% by weight in homogeneous materials
Cadmium	0.01% by weight in homogeneous materials

The products covered by this certificate include:

Product Name	Eurotech Ltd Part Number
ZEUS	ZEUS-Mx-Fy-ZZZ-R6 (all variants)
ZEUS-FPIF	ZEUS-FPIF-R6
ZEUS-FPIF-CRT	ZEUS-FPIF-CRT-R6
ZEUS MODEM -1	ZEUS MODEM-1-R6
ZEUS MODEM-2	ZEUS MODEM-2-R6
ZEUS MODEM -3	ZEUS-MODEM3-R6

Note: All recommended wireless modems are RoHS compliant with exception of the iO270 iDEN module.

Eurotech Ltd has based its material content knowledge on a combination of information provided by third parties and auditing our suppliers and sub-contractor's operational activities and arrangements. This information is archived within the associated Technical Construction File. Eurotech Ltd has taken reasonable steps to provide representative and accurate information, though may not have conducted destructive testing or chemical analysis on incoming components and materials.

Additionally, packaging used by Eurotech Ltd for its products complies with the EU Directive 2004/12/EC in that the total concentration of the heavy metals cadmium, hexavalent chromium, lead and mercury do not exceed 100 ppm.

# Index

---

## A

abbreviations · 131  
 acronyms · 131  
 active display signal · 45  
 address map · 19  
 anti-static · 5  
 Arcom, contacting · 97  
 assignments, GPIO pins · 22, 29  
 audio · 16, 49  
     connector · 79  
     power management · 71

---

## B

backlight  
     brightness · 47  
     inverter connector · 127  
     power · 92  
 Base TX Ethernet · 52  
 battery  
     backup · 65  
     disconnect · 93, 95  
 block diagram · 18  
 board · 6  
     address map · 19  
     block diagram · 18  
     diagram · 8  
     features · 10  
     hardware description · 18  
     mechanical diagram · 100  
     specification · 98  
     variants · 6  
 boot loader · 17  
 bus  
     expansion · 17  
     I<sup>2</sup>C · 58

---

## C

camera interface · 59  
     connector · 82  
 CAN bus · 87  
     power management · 72  
     termination · 95  
 CF+ · 40  
 clock · 31  
     generator power management · 72

COM1 · 53, 83  
 COM2 · 53, 86  
 COM3 · 54, 88  
 COM4 · 55, 88  
 CompactFlash · 16, 34, 40  
     connector · 89  
     power management · 70  
 configuration PROM power management · 73  
 connectors · 74, 76  
 contact details · 97  
 contacting Arcom · 97

---

## D

debug access · 62  
 display · 44

---

## E

electromagnetic compatibility · 5  
 EMC · 5  
 environmental compliance · 5, 133  
 Ethernet · 17, 52  
     connector · 80  
     power management · 71  
 expansion  
     bus · 17  
     interfaces · 38  
 external interrupt · 28

---

## F

Flash  
     LED · 96  
     memory · 33  
 flat panel display · 44  
 flat panel interface · 13  
 FPIF · 123

---

## G

general purpose I/O · 60  
 GPIO  
     connector · 81  
     pin assignments · 22, 29

---

**H**hardware description · 18

---

**I**I/O expander, power management · 73  
I<sup>2</sup>C bus · 58  
interface · 52  
internal interrupt · 28  
interrupt · 28  
    external · 28  
    internal · 28

---

**J**J1 · 77  
J10 · 82  
J11 · 83  
J12 · 84  
J13 · 84  
J14 · 85  
J15 · 86  
J16 · 86  
J17 · 87  
J18 · 87  
J19 · 88  
J2 · 78  
J20 · 89  
J21 · 90  
J22 · 90  
J23 · 91  
J24 · 92  
J3 · 78  
J4 · 79  
J5 · 79  
J6 · 80  
J7 · 81  
J8 · 81  
J9 · 82  
JP1 · 93  
JP2 · 93, 95  
JP3 · 94  
JP4 · 94  
JP5 · 95  
JP6 · 95  
JTAG · 62  
    connector · 79  
jumper diagrams · 14  
jumpers · 74, 93

---

**K**key · 14

---

**L**LAN · 17

---

LCD · 13, 44, 123, 128  
    backlight brightness · 47  
    connector · 85  
    generic connector · 125  
    SBC cable connector · 124, 129  
LCD logic supply selection · 94  
LEDs · 74, 96  
Linux, PC/104 interrupts · 42  
LTC3442 · 64  
LVDS  
    connector · 86  
    interface · 47  
    MSL selection · 94  
    power management · 71

---

**M**map, address · 19  
materials declaration form · 133  
MAX6369 · 32  
mechanical diagram · 100  
memory · 33  
modem boards · 13

---

**P**passive display signal · 45  
PC/104 · 41  
    connector · 84  
PC/104 interrupts · 42  
port, serial · 53, 57  
power · 63  
    connector · 63, 78  
    management · 66, 68, 70  
    supply · 63  
    USB · 70  
    voltage · 63, 64  
processor  
    power management · 66  
    PXA255 · 20  
PXA255 · 20

---

**Q**Quick Capture camera interface · 59

---

**R**RAM, static · 34  
real time clock · 31  
reference information · 102  
RoHS-6 compliance · 133  
RS232 · 16, 53, 54  
RS422 · 16, 55, 87  
RS485 · 16, 55, 87

---

---

**S**

sales team · 97  
SDIO · 39  
    socket · 90  
SDRAM · 33  
serial ports · 16, 53, 57, 83, 86, 87, 88  
silicon disk · 33  
sleep mode · 67  
source code · 97  
specification · 98  
static · 5  
static RAM · 34  
STN · 13, 45, 123, 128  
    bias connector · 127  
    bias voltage · 47  
support products · 13  
support, technical · 97  
symbols · 14

---

**T**

tables · 15  
technical support · 97  
temperature sensor · 61  
    power management · 73  
TFT · 44, 123  
timer, watchdog · 32  
touch screen  
    connector · 77  
touchscreen · 50

---

**U**

USB  
    client header · 82  
    connector · 81  
    interface · 51  
    ports · 16  
    power · 70  
    power management · 70  
user jumpers · 93  
user LEDs · 96

---

**V**

VBUSx · 70

---

**W**

wake-up · 67  
watchdog timer · 32  
wireless  
    interface · 91  
    support · 35

---

**Z**

ZigBee · 13  
    connector · 90

---

**S**

sales team · 97  
SDIO · 39  
    socket · 90  
SDRAM · 33  
serial ports · 16, 53, 57, 83, 86, 87, 88  
silicon disk · 33  
sleep mode · 67  
source code · 97  
specification · 98  
static · 5  
static RAM · 34  
STN · 13, 45, 123, 128  
    bias connector · 127  
    bias voltage · 47  
support products · 13  
support, technical · 97  
symbols · 14

---

**T**

tables · 15  
technical support · 97  
temperature sensor · 61  
    power management · 73  
TFT · 44, 123  
timer, watchdog · 32  
touch screen  
    connector · 77  
touchscreen · 50

---

**U**

USB  
    client header · 82  
    connector · 81  
    interface · 51  
    ports · 16  
    power · 70  
    power management · 70  
user jumpers · 93  
user LEDs · 96

---

**V**

VBUSx · 70

---

**W**

wake-up · 67  
watchdog timer · 32  
wireless  
    interface · 91  
    support · 35

---

**Z**

ZigBee · 13  
    connector · 90

## Free Manuals Download Website

<http://myh66.com>

<http://usermanuals.us>

<http://www.somanuals.com>

<http://www.4manuals.cc>

<http://www.manual-lib.com>

<http://www.404manual.com>

<http://www.luxmanual.com>

<http://aubethermostatmanual.com>

Golf course search by state

<http://golfingnear.com>

Email search by domain

<http://emailbydomain.com>

Auto manuals search

<http://auto.somanuals.com>

TV manuals search

<http://tv.somanuals.com>