

Volume

1



Instruction Manual



EDSR400H

EVERFOCUS ELECTRONICS CORPORATION

EDSR 400h Instruction Guide

© 2004 Everfocus Electronics Corp
2445 Huntington Drive
Phone 626.844.8888 • Fax 626.844.8838

All rights reserved. No part of the contents of this manual may be reproduced or transmitted in any form or by any means without written permission of the Everfocus Electronics Corporation.

QuickTime is a registered trademark of the Apple Computer, Inc. Windows is a registered trademark of the Microsoft Corporation in the United States and other countries. Linksys is a registered trademark of the Linksys Corporation. D-Link is a registered trademark of the D-Link Corporation. DynDNS is a registered trademark of the DynDNS.org Corporation. Other product and company names mentioned herein may be the trademarks of their respective owners.

Table of Contents

Introduction	I		
C H A P T E R 1		C H A P T E R 4	
Product Overview	1	Recording Overview	40
Features	1	Basic Recording Setup	40
Specifications	2	Timer Recording Setup	41
Front Panel Keys	3	Motion Recording Setup	42
Back Panel Keys	5	Alarm Recording Setup	43
C H A P T E R 2		C H A P T E R 5	
Installation	8	Playback Overview	45
Basic Wiring Instructions	9	Basic Playback	45
Hard Disk Drive Installation	10	Search Playback	46
Final Install Process	10	Segment List Playback	46
		Alarm List Playback	47
		Date/Time Playback	48
C H A P T E R 3		C H A P T E R 6	
DVR Menu Setup	11	Copying Video	50
Clock/Language Setting Menu	12	Still Image Copy	50
Title Setting Menu	14	Copy as a MOV File	51
Daylight Setting Menu	15	Other Archiving Methods	52
Timer Setting Menu	17	Viewing Copied Files	52
Normal Record Setting Menu	19		
Alarm Record Setting Menu	21	C H A P T E R 7	
Buzzer Setting Menu	24	Audio Overview	53
Archive Setting Menu	26	C H A P T E R 8	
Network Setting Menu	28	How to Upgrade Firmware?	54
Sequence Setting Menu	30	C H A P T E R 9	
RS232/RS485 Setting Menu	32	Networking Overview	56
Motion Setting Menu	35	Introduction to TCP/IP	56
System Setting Menu	38	Subnet Masks	56

Gateway Address	57		
Virtual Ports	57	C H A P T E R 1 3	
Pre-Installation	58	Viewing through Internet Explorer	85
What type of Network Connection	59		
Simple One to One Connection	60	C H A P T E R 1 4	
Direct High Speed Modem Connection	66	Interface Specifications	89
Router or LAN Connection	68	Transmission Setting	90
		Remote Control Protocol	90
C H A P T E R 1 0			
Linksys Port Forwarding	71	A P P E N D I X A	
Dynamic DNS	75	Remote Control	93
C H A P T E R 1 1			
D-Link Port Forwarding	77	A P P E N D I X B	
Dynamic DNS	80	Time Lapse Recording Time	94
C H A P T E R 1 2			
DDNS	82	A P P E N D I X C	
Creating a DDNS Account	82	Alarm Board Configuration	96
		T R O U B L E S H O O T I N G	
		Troubleshooting	99

Product Overview

DVRs are the industry's first full-featured digital video recorder designed specifically for use within the security industry. The Digital Video Recorder incorporates all the benefits of digital video recording, is simple to install, and operates just like a VCR. Highly efficient compression technology and superior resolution of recorded images make the Digital Video Recorder stand out from the competition as the best choice for security surveillance.

Features

- Easy-to-use control panel with common VCR and Multiplexer functions.
- Shuttle/Jog dial for picture-by-picture or fast/slow viewing.
- No tapes to manage, clean, or replace.
- Instant retrieval of stored video.
- On-screen setup menu and system timer.
- Ethernet TCP/IP connectivity for remote viewing.
- Pre-Alarm and Post-Alarm process.
- Built-in M-JPEG compression/decompression with configurable quality.
- Programmed with various time-lapse speeds.
- 3.5" IDE Type Hard Disks for storage with Hot-Swap tray.
- RS232 and RS485 for Remote Control.
- Real-Time Live Display for all Cameras.
- Variable recording speeds up to 60/50 fps for NTSC/PAL.
- Alarm-activated recording.
- Data can be stored in a Compact Flash Card.
- Audio recording capabilities.

Specifications

Video Format	NTSC/PAL
Video Input	4 camera inputs (BNC),1Vp-p/75ohm
Video Output	1 BNC video out (1Vp-p/75 ohm) for Main Monitor 1 BNC video out (1Vp-p/75 ohm) for CALL Monitor 4 video out (1Vp-p/75ohm)for looping
Video Compression	M-JPEG
Recording Resolution	720x484 (NTSC); 720x576 (PAL)
Compact Flash Memory	Yes, Built-in Compact Flash card slot
Alarm Input	4 alarm inputs
Alarm Output	1 alarm outputs
Video Display	Full, PIP, Quad and 2x2 zoom for Live and Playback
Video Loss Detection	Yes
Ethernet	RJ45 connectors for network communications
Event Log	Yes
Hard Disk Storage	3.5" IDE type, Hot- swappable
Recording Mode	Continuous, Time-lapse recording, Schedule or Event Recording
Recording Rate	Up to 60/50 fps for NTSC/PAL
Playback Rate	Up to 60/50 fps for NTSC/PAL
Playback Search	By Date/Time or Event/Segment
Setup	On screen display setup
User Interface	Menu Driven
User Input Device	Front Panel Keypad
Timer	Built-in real time clock
Watch Dog Timer	Yes
RS-232	9-pin female connector
RS485	RJ11 Connector
Dimension	320.8mm (L) x 215mm (W) x 100mm (H)
Operating Temperature	0C~+40C
Power Consumption	60 W
Power Source	AC100~240V

Front Panel Keypads

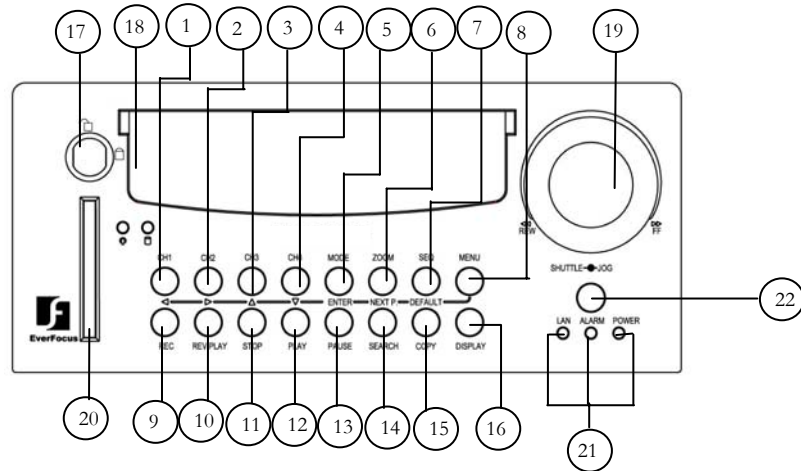

Keys:

- ① ~ ④ **CH1 ~CH4:** Press channel key (1~4) to display the video image in full screen format for the channel specified.
- ⑤ **MODE:** Press to switch between Picture-In-Picture and Quad modes.
- ⑥ **ZOOM:** Pressing this key while viewing a full screen image will display a magnified resolution of the image on the monitor.
- ⑦ **SEQ:** Press this key to enter the auto sequential switching mode.
- ⑧ **MENU:** Press this key to enter Setup menu.
- ⑨ **REC :** Press this key to start recording.
- ⑩ **REV. PLAY :** Pressing this key will start reverse playback.
- ⑪ **STOP :** Press this key to stop recording and playback.
- ⑫ **PLAY:** Press this key to playback.
- ⑬ **PAUSE:** Press this key to pause the playback picture.
- ⑭ **SEARCH:** Press this key to enter the Search Menu.
- ⑮ **COPY:** Under **PAUSE** or **PLAYBACK**, Press this key to start copy still picture or video stream onto a Compact Flash card.

- 16 **Display:** Pressing this key once will turn the display on. Pressing it a second time will give you Hard Disk Drive statistics.

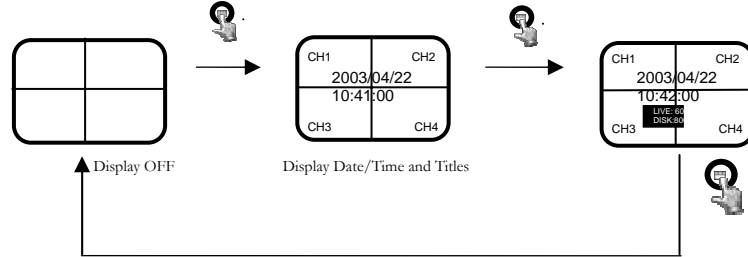

- 17 **HDD KEY:** Turning this key to the lock position will activate the Hard Drive for recording and keep it securely locked into the DVR.
- 18 **Hard Disk Tray:** Hard Disk holder for HDD.

19 **Shuttle and Jog Dial**

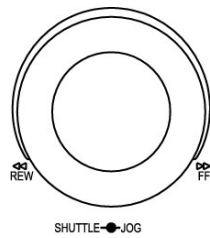

Shuttle : In Playback mode, turn the shuttle dial can fast forward/rewind the picture.
In Pause mode, turn the shuttle dial can slow forward/rewind the picture.

Jog Dial : In Pause mode, turn the jog dial can forward/rewind the Picture.
In Menu mode turn the jog dial to change setting Menu page.

- 20 **Compact Flash Card Slot:** Insert a Compact Flash Card.
- 21 **LEDs:** LEDs for system active power ,LAN and ALARM access.
- 22 **Remote Control:** IR Remote receiver

Back Panel Connections

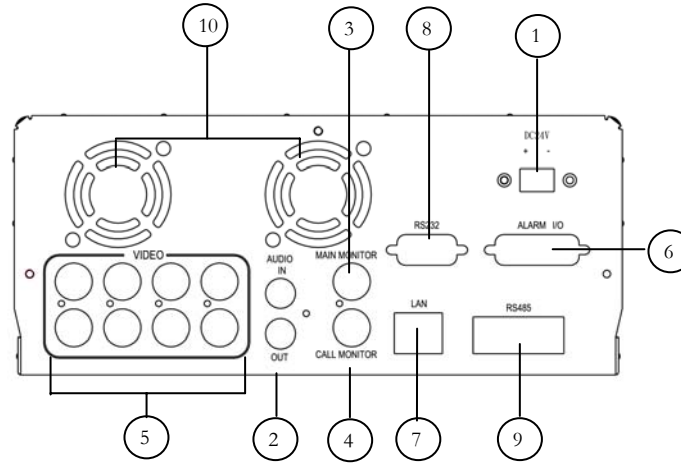

POWER

- ① **Main Power plug:** Connect the DC12~24V power source to Adapter for AC100~240V.

AUDIO

- ② **Audio IN:** Audio input for recording.
Audio OUT: Audio output can be set to “ON” or “OFF” in Setup Menu.

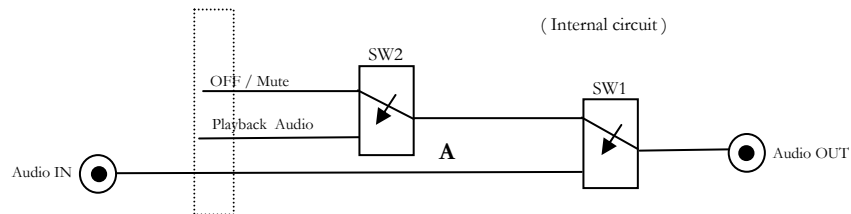

Operation of SW1:

When in recording or standby mode, the out of SW1 is connected to Audio IN.
 When in playback mode the out of SW1 is connected to SW2 Audio.

Operation of SW2:

When Playback Audio is enabled then the output of SW2 will be connected to Playback Audio.
 When Playback Audio is disabled then there is no audio output (MUTE).

When Audio Out is enabled and machine is in Recording or Standby mode, the Audio IN is loop-through to Audio Out connector. When Audio Out is enabled and machine is in Playback mode then the Audio Out playback audio.

MONITOR

- ③ **MAIN MONITOR:** This connector is used for the Main monitor display, a number of different display modes may be selected for viewing. This output must be used to display the menu settings.
- ④ **CALL MONITOR:** This connector is used for the Call (secondary) monitor. This monitor can only display full screen pictures.

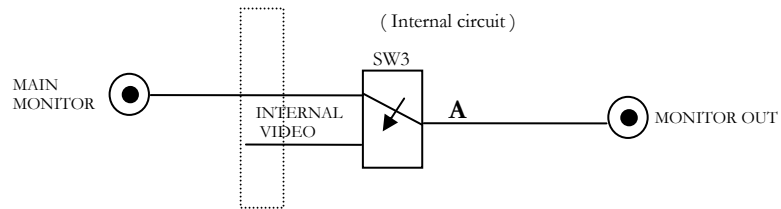

When the machine is in Menu, Search or Copy mode, the internal Video is switched to Monitor Out, so that the user can view full screen OSD. In other modes, the Video from multiplexer main monitor will be loop-through to the Monitor Out.

VIDEO In/Output

- ⑤ **VIDEO IN (1~4):** The BNC connectors of video input enable the system to receive the signals from each camera through the 75 ohm coaxial cables.
- VIDEO OUT (1~4):** Sends the signals from each camera to other external devices (loop out).

Alarm Input/ Output

⑥ **Alarm Input**

ALARM-INPUT: Normal Open or Normal Close type alarm sensor input. The Alarm Input can be selected as Normal Open or Normal Close input in the setup menu. When an alarm occurs, alarm recording will automatically start.

ALARM-OUTPUT: Normal Close Alarm output. In normal condition, this terminal is shorted to the terminal of ALARM-COM. In alarm status, it is open between ALARM-NC and ALARM-COM terminals.

LAN

- ⑦ **LAN Connector:** The RJ-45 LAN connector used to connect to a local area network.

RS232

- ⑧ **RS232 connector:** Connect D-Sub 9 pin connector to RS232 port for remote control.

RS485

- ⑨ **RS485 connector:** RJ 45 Connector to Cascade multi Digital Video Recorder.

- ⑩ **FAN:** Cooling FAN.

Installation

The installations described below should be made by qualified service personnel or system installers.

Please refer to the following diagram for the basic wiring connections.

- Please note: Monitors and Cameras must be purchased separately.

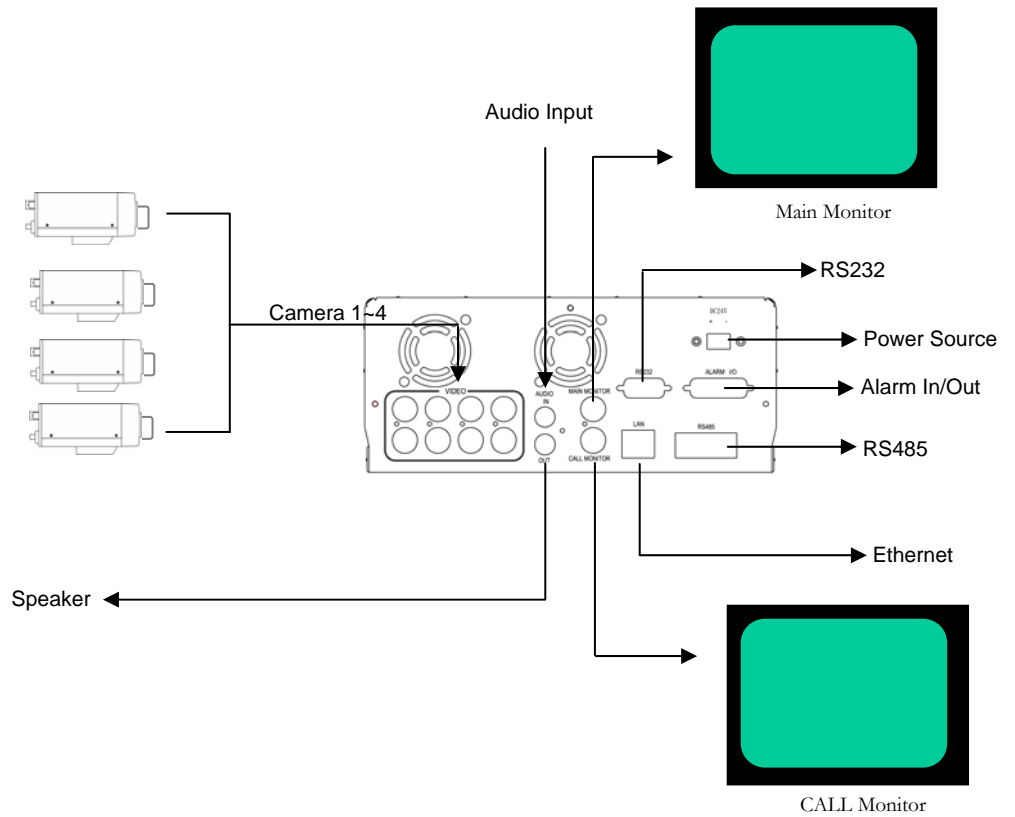

Diagram 1

Basic Wiring Instructions

Please refer to diagram 1 on page 9 to assist you with this portion of the installation.

- **Power:** Connect the power source or adapter into the power socket shown in diagram 1.
 - Please note: Do not plug the digital video recorder into the same power source as the cameras.
- **Cameras:** Connect each camera's video output to the video input on the digital video recorder shown in diagram 1.
 - Please note: At least one camera must be connected before the system is running for the auto detection of video standard to take effect.
- **Audio Input:** The camera audio output or Microphone is connected to the audio input terminal at the rear panel.
- **Speaker:** Connect the speaker or other audio listening devices to the audio output terminal on the back of the digital video recorder.
- **Ethernet:** The digital video recorder may be viewed from a PC via the LAN connector using a RJ45 Ethernet cable.
- **RS232/RS485:** The digital video recorder may be controlled from a PC via RS232/RS485.
 - Please note: This can be done using a serial cable.
- **Main Monitor:** Connect the main monitor output connector to a main monitor. The main monitor displays selected live or recorded cameras in any available format.
 - Please note: The main monitor must be connected in order to make configuration changes, enter the main menu, or do a playback at the machine.
- **Call Monitor:** Connect the call monitor output connector to a call monitor. The call monitor displays selected live cameras in full screen format.
 - Please note: The call monitor will only display one full screen camera at a time.

Hard Disk Drive Installation

The first step in installing the hard drive is to insert the hard drive sleeve into the machine. The hard disk drive default setting is initially set to master. The second step is to insert the key provided and turn the tray key to the lock position. If this process is ignored the hard disk drive will not be detected.

- Please note: If the Hard Disk Drive is not locked in with the key a system loading screen will keep flashing and the DVR will not go into record mode.

Final Install Process

Once you have completed the basic wiring installation and the hard disk drive installation you are read to turn on the DVR. Simply plug the power source you installed earlier. The POWER LED lights will light up if power is normal. The next step is to set up the menu options for the DVR.

DVR Menu Setup

Assuming you have completed the first two chapters of this manual. You are now ready to begin setting up the digital video recorder menu. To begin this process press the **MENU** key. Once inside the main menu you will find there are 13 setup option pages as follows.

1. **CLOCK/LANGUAGE SETTING MENU**
2. **TITLE SETTING MENU**
3. **DAYLIGHT SAVING SETTING MENU**
4. **TIMER SETTING MENU**
5. **NORMAL RECORD SETTING MENU**
6. **ALARM RECORD SETTING MENU**
7. **BUZZER SETTING MENU**
8. **ARCHIVE SETTING MENU**
9. **NETWORK SETTING MENU**
10. **SEQUENCE SETTING MENU**
11. **RS232/RS485 SETTING**
12. **MOTION RECORD SETTING MENU**
13. **SYSTEM SETTING MENU**

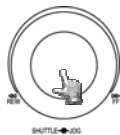

Turning the jog dial clockwise or counter clockwise will allow you to scroll through the different menu setup option pages.

Clock/Language Setting Menu



Diagram 2

Diagram two is a screen shot of the Clock/Language Setting Menu. In the Clock/Language Setting Menu the following fields are defined as follows:

- **Date:** This field represents the current date on the DVR. To change this, simply use the arrow keys on the DVR which also represent the channel 1-4 keys (These are the top four buttons). Use the up and down arrow keys to make your selection.

The date is represented as follows:

Year: 2000~2099 / Month: 01~12 / Date: 01~31 (Day of Week)



- **Time:** This field represents the current time on the DVR which is in military time. To change this, simply use the arrow keys on the DVR which also represent the channel 1-4 keys (These are the top four buttons). Use the up and down arrow keys to make your selection.

The date is represented as follows:

Hour: 00~23 : Minute: 00~59 : Second: 00~59

- Menu Language: This field is set to English from factory and can not be changed.
- Video System: This field is set to NTSC from factory which is the North American Video Standard and can not be changed. The European and Asian Video Standards are PAL.
- Version: This field represents the firmware version the digital video recorder is using.
 - Please note: New firmware versions are available for download from our ftp site. <ftp://everfocus.dyndns.org/> (see page for firmware upgrade instructions)
- Release Date: This field represents the date the firmware was released.



: Press  or  to move the cursor to the left or right.

: Press  or  to change the value.

These keys are located at the top left row of keys (same keys as channel 1-4).

Title Setting Menu



Diagram 3

Diagram three is a screen shot of the Title Setting Menu. In this menu you can set a unique title for each of your cameras. To change this, simply use the arrow keys on the DVR which also represent the channel 1-4 keys (These are the top four buttons). Use the up and down arrow keys to make your selection.

➤ Example:

CH1 : FrontDoor
 CH2 : BackDoor
 CH3 : Hallway
 CH4 : Closet



: Press ◀ or ▶ to move the cursor to the left or right.

: Press ▲ or ▼ to change the value.

These keys are located at the top left row of keys (same keys as channel 1-4).

Daylight Setting Menu





Diagram 4

Diagram four is a screen shot of the Daylight Saving Setting Menu. In this menu you can set the DVR to adjust the daylight savings time automatically for you.

- Daylight saving: This field is to turn the daylight savings function on or off. To change this, simply use the arrow keys on the DVR which also represent the channel 1-4 keys (These are the top four buttons). Use the up and down arrow keys to make your selection.
- Start Time: This field signifies the date the daylight savings will take affect.
 - The first field is set to “First”. This signifies the week of the month the daylight savings time will change. Your options are: first, second, third, fourth, or last. Use the up and down arrow keys to make your selection.
 - The next field is set to “Sun”. This represents the day of the week the daylight savings time will take affect. Your options are: Sun, Mon, Tue, Wed, Thurs, Fri, or Sat. Use the up and down arrow keys to make your selection.

- The third field is set to “March”. This signifies the month in which the daylight savings time will occur. Your options are: Jan through Dec. Use the up and down arrow keys to make your selection.
 - The last two fields represent the time. Use the up and down arrow keys to choose the time you want to go from to the time you want it to be.
- Stop Time: This field represents when the daylight savings time will come to an end. Use the same steps you used for the Start Time to make the necessary changes for the Stop Time.



: Press  or  to move the cursor to the left or right.

: Press  or  to change the value.

These keys are located at the top left row of keys (same keys as channel 1-4).

Timer Setting Menu

TIMER SETTING MENU				
WEEK	START	STOP	SPEED	SET
SUN	00:00	23:59	60 IPS	OFF
SUN	00:00	23:59	60 IPS	OFF
SUN	00:00	23:59	60 IPS	OFF
SUN	00:00	23:59	60 IPS	OFF
SUN	00:00	23:59	60 IPS	OFF
SUN	00:00	23:59	60 IPS	OFF
SUN	00:00	23:59	60 IPS	OFF
SUN	00:00	23:59	60 IPS	OFF
SUN	00:00	23:59	60 IPS	OFF
SUN	00:00	23:59	60 IPS	OFF
SUN	00:00	23:59	60 IPS	OFF
SUN	00:00	23:59	60 IPS	OFF

Diagram 5

Diagram five is a screen shot of the Timer Setting Menu. In this menu you can set a unique timer any day of the week to start recording from a specified start time to an end time. In the Timer Setting Menu the following fields are defined as:

- **Week:** This field represents the day of the week you wish to set the timer record for. Initially it is set to Sun as default. You may choose from Mon-Sun as well as DLY. If you wish to create a daily timer for every day of the week you may choose the DLY option. To change this, simply use the arrow keys on the DVR which also represent the channel 1-4 keys (These are the top four buttons). Use the up and down arrow keys to make your selection.
- **Start:** This field is used to set the time you wish to start the timer recording. To change this, simply use the arrow keys on the DVR which also represent the channel 1-4 keys (These are the top four buttons). Use the up and down arrow keys to make your selection.
- **Stop:** This field is used to set the time you wish to stop the timer recording. To change this, simply use the arrow keys on the DVR which also represent the channel 1-4 keys (These are the top four buttons). Use the up and down arrow keys to make your selection.

- Speed: This field is used to set the speed at which you would like the timer record to be recording at. To change this, simply use the arrow keys on the DVR which also represent the channel 1-4 keys (These are the top four buttons). Use the up and down arrow keys to make your selection.
 - Please Note: See Appendix B to find the appropriate speed to fit your recording needs.
- Quality: This field is for setting up video recording quality, this item lets you set the quality of the video picture by selecting a compression rate.



There are six quality levels for recording:



- Lower : 15KB
- Low : 19KB
- Basic : 23KB
- Standard : 27KB
- High : 31KB
- Superior : 35KB

To change this, simply use the arrow keys on the DVR which also represent the channel 1-4 keys (These are the top four buttons). Use the up and down arrow keys to make your selection.

- Set: This field is used to turn the timer recording on or off. To change this, simply use the arrow keys on the DVR which also represent the channel 1-4 keys (These are the top four buttons). Use the up and down arrow keys to make your selection.
 - Please note: If you wish to do any form of playback this feature must be turned off before attempting to playback.



: Press  or  to move the cursor to the left or right.

: Press  or  to change the value.

These keys are located at the top left row of keys (same keys as channel 1-4).

Normal Record Setting Menu

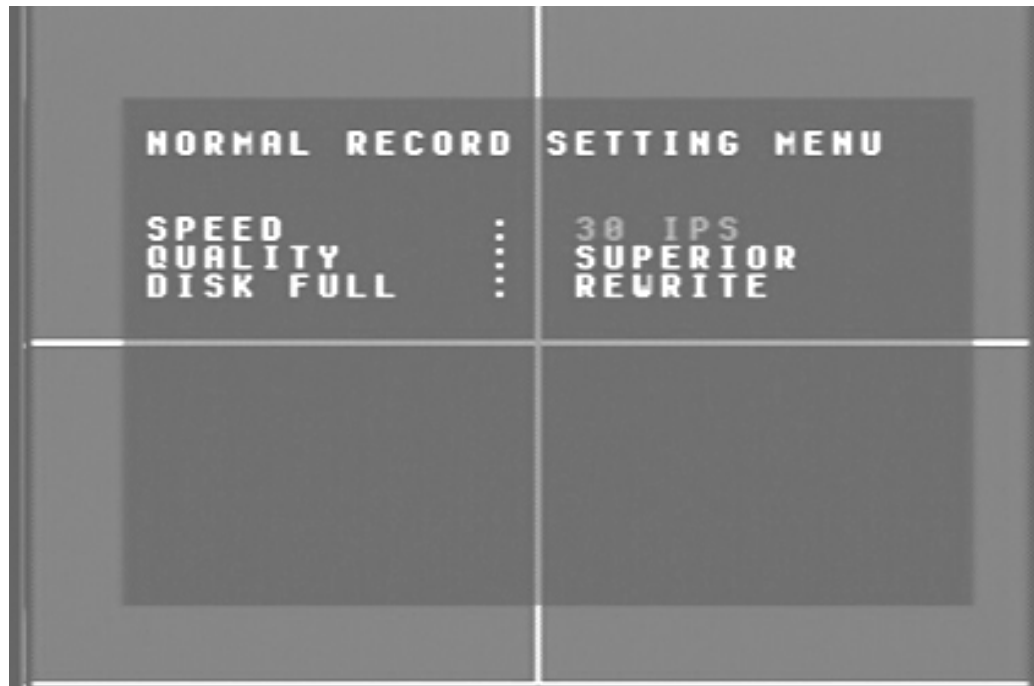

Diagram 6

Diagram six is a screen shot of the Normal Record Setting Menu. This menu contains the speed and quality for recording all the time. In the Normal Record Setting Menu the following fields are defined as:

- Speed: This field represents the speed at which the recorder will be recording all the time. To change this, simply use the arrow keys on the DVR which also represent the channel 1-4 keys (These are the top four buttons). Use the up and down arrow keys to make your selection.
 - Please Note: See Appendix B to find the appropriate speed to fit your recording needs.
- Quality: This field is for setting up video recording quality, this item lets you set the quality of the video picture by selecting a compression rate.

There are six quality levels for recording:



- Lower : 15KB
- Low : 19KB
- Basic : 23KB
- Standard : 27KB

- High : 31KB
- Superior : 35KB

To change this, simply use the arrow keys on the DVR which also represent the channel 1-4 keys (These are the top four buttons). Use the up and down arrow keys to make your selection.

- Disk Full: This field represents what to do when the Hard Disk Drive gets full. In this case the default is set to Rewrite. The other option if you wish to do so is to set the disk full option to Stop. This will stop all recording once the drive has been filled up. You would then have to go to System Setting Menu and do a Disk Renew in order to format the drive and start recording again. To change this, simply use the arrow keys on the DVR which also represent the channel 1-4 keys (These are the top four buttons). Use the up and down arrow keys to make your selection.



: Press  or  to move the cursor to the left or right.

: Press  or  to change the value.

These keys are located at the top left row of keys (same keys as channel 1-4).

Alarm Record Setting Menu



Diagram 7

Diagram seven is a screen shot of the Alarm Record Setting Menu. This menu contains all the alarm operations and options needed to successfully complete an alarm recording. In the Alarm Record Setting Menu the following fields are defined as:

- Alarm Operations: This field is to turn alarm recording on or off. The Default from the factory is set to on. To change this, simply use the arrow keys on the DVR which also represent the channel 1-4 keys (These are the top four buttons). Use the up and down arrow keys to make your selection.
- Recording Speed: This field represents the speed at which the recorder will be recording the alarm event. To change this, simply use the arrow keys on the DVR which also represent the channel 1-4 keys (These are the top four buttons). Use the up and down arrow keys to make your selection.
 - Please Note: See Appendix B to find the appropriate speed to fit your recording needs.
- Recording Quality: This field is for setting up video recording quality, this item lets you set the quality of the video picture for the alarm event by selecting a compression rate.

There are six quality levels for recording:

▪ Lower	:	15KB
▪ Low	:	19KB
▪ Basic	:	23KB
▪ Standard	:	27KB
▪ High	:	31KB
▪ Superior	:	35KB



To change this, simply use the arrow keys on the DVR which also represent the channel 1-4 keys (These are the top four buttons). Use the up and down arrow keys to make your selection.

- Alarm 1-4 Types: These fields represent what to do when a signal is received from the alarm board connector. There are two types of alarm signals. The first is N.O. which stands for Normally Open circuit. The Second is N.C. which stands for Normally Closed circuit. The default setting is N.O. This option would be set according to the type of alarm input connected to the alarm board. For example if you connected a door sensor which was a Normally Open circuit you would set the alarm type to N.O. To change this, simply use the arrow keys on the DVR which also represent the channel 1-4 keys (These are the top four buttons). Use the up and down arrow keys to make your selection.
 - Please note: Refer to Appendix D for more information about setting up the alarm board.
- Alarm Reset Type: This field is to set the alarm signal back to normal. If you have a N.O. alarm in the alarm types you would set it back to N.O. If you have a N.C. circuit you would set it back to N.C. To change this, simply use the arrow keys on the DVR which also represent the channel 1-4 keys (These are the top four buttons). Use the up and down arrow keys to make your selection.
- Alarm Duration Time: When any sensor alarm connected to the device is activated, the device will immediately react an alarm and display the warning message. This entry is used to set the alarm duration from 1 to 99 seconds. To change this, simply use the arrow keys on the DVR which also represent the channel 1-4 keys (These are the top four buttons). Use the up and down arrow keys to make your selection.
- Pre-Alarm Operation: This feature turns the pre-alarm recording on or off. To change this, simply use the arrow keys on the DVR which also

represent the channel 1-4 keys (These are the top four buttons). Use the up and down arrow keys to make your selection.

- Recording Speed: This option is to set the speed of the pre-alarm recording. To change this, simply use the arrow keys on the DVR which also represent the channel 1-4 keys (These are the top four buttons). Use the up and down arrow keys to make your selection.



: Press  or  to move the cursor to the left or right.

: Press  or  to change the value.

These keys are located at the top left row of keys (same keys as channel 1-4).

Buzzer Setting Menu

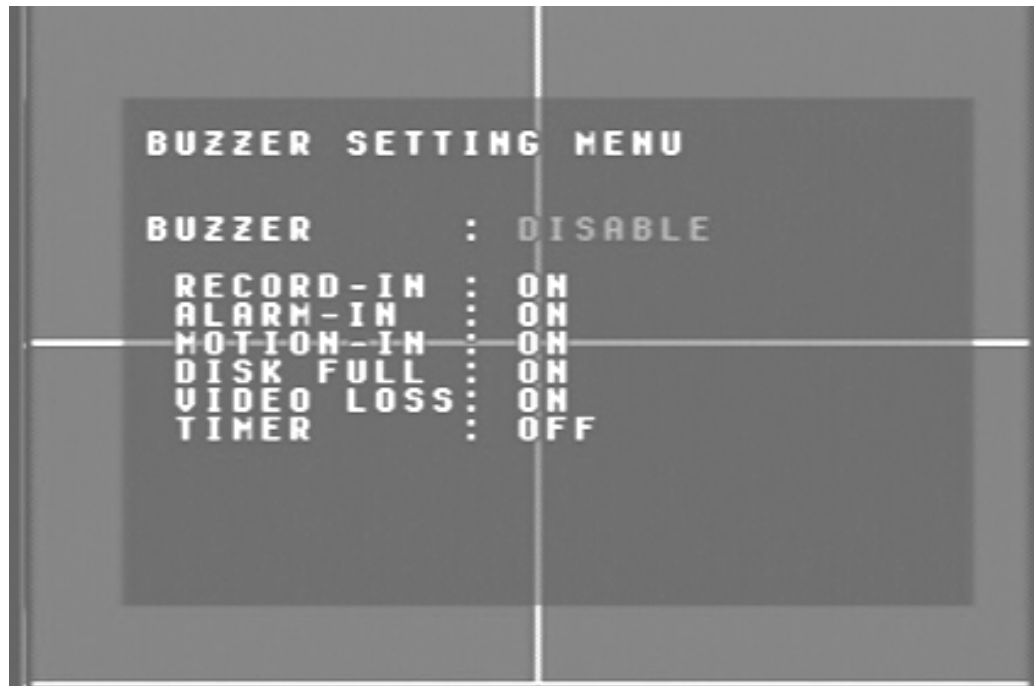

Diagram 8



Diagram eight is a screen shot of the Buzzer Setting Menu. This menu is to set the internal buzzer. In the Buzzer Setting Menu the following fields are defined as:



- **Buzzer:** This field is to turn the internal buzzer enable or disable the internal buzzer. The default is set to enable. To change this, simply use the arrow keys on the DVR which also represent the channel 1-4 keys (These are the top four buttons). Use the up and down arrow keys to make your selection.
- **Record-In:** This option is to turn the buzzer on or off when the DVR is in record mode. To change this, simply use the arrow keys on the DVR which also represent the channel 1-4 keys (These are the top four buttons). Use the up and down arrow keys to make your selection.
- **Alarm-In:** This field is to turn the buzzer on or off when alarm recording is enabled. To change this, simply use the arrow keys on the DVR which also represent the channel 1-4 keys (These are the top four buttons). Use the up and down arrow keys to make your selection.
- **Motion-In:** This option is to turn the buzzer on or off when motion recording is enabled. To change this, simply use the arrow keys on the

DVR which also represent the channel 1-4 keys (These are the top four buttons). Use the up and down arrow keys to make your selection.

- Disk Full: This field is to turn the buzzer on or off when the Hard Disk Drive is full. To change this, simply use the arrow keys on the DVR which also represent the channel 1-4 keys (These are the top four buttons). Use the up and down arrow keys to make your selection.
- Video Loss: This option is to turn the buzzer on or off when the DVR experiences video loss. To change this, simply use the arrow keys on the DVR which also represent the channel 1-4 keys (These are the top four buttons). Use the up and down arrow keys to make your selection.
- Timer: This field is to turn the buzzer on or off when timer recording is activated. To change this, simply use the arrow keys on the DVR which also represent the channel 1-4 keys (These are the top four buttons). Use the up and down arrow keys to make your selection.



: Press  or  to move the cursor to the left or right.

: Press  or  to change the value.

These keys are located at the top left row of keys (same keys as channel 1-4).

Archive Setting Menu

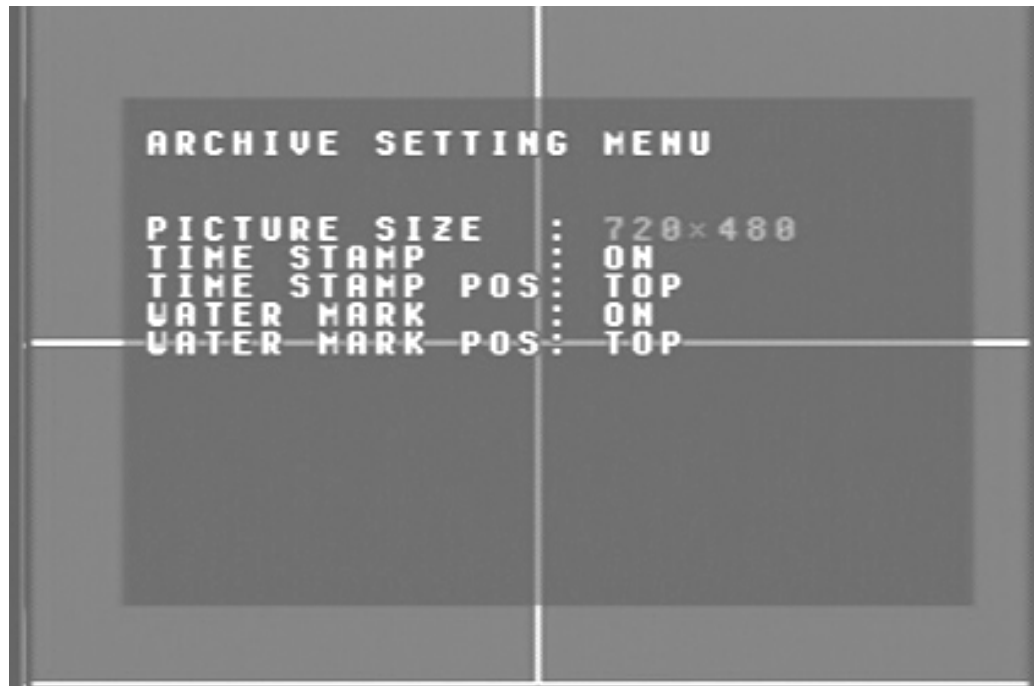

Diagram 9

Diagram nine is a screen shot of the Archive Setting Menu. This menu is for setting up the way in which video is archived within the machine. In the Archive Setting Menu the following fields are defined as follows:

- Picture Size: This field is to set the picture size for copying an image to a Compact Flash card or through the network. Initial default is set to the larger size 720 x 480 for NTSC or 720 x 576 for PAL. The smaller size is 352 x 240 for NTSC or 352 x 288 for PAL.
 - Please Note: To speed up refresh rate through the network set picture size to 352 x 240 for NTSC or 352 x 288 for PAL.



To change this, simply use the arrow keys on the DVR which also represent the channel 1-4 keys (These are the top four buttons). Use the up and down arrow keys to make your selection.



- Time Stamp: This option is to turn the time stamp on or off when the DVR is in record mode. The time stamp will appear when archiving through the network or to a Compact Flash card. To change this, simply use the arrow keys on the DVR which also represent the channel 1-4 keys

(These are the top four buttons). Use the up and down arrow keys to make your selection.

- Time Stamp Position: This field is to set the position of the time stamp. You can set the time position either on top or bottom. The default is set to top. To change this, simply use the arrow keys on the DVR which also represent the channel 1-4 keys (These are the top four buttons). Use the up and down arrow keys to make your selection.
- Water Mark: This option is to turn water mark on or off when copying to a Compact Flash card. By default this option is turned on. To change this, simply use the arrow keys on the DVR which also represent the channel 1-4 keys (These are the top four buttons). Use the up and down arrow keys to make your selection.
- Water Mark Pos: This field is set the water mark position. You can set the water mark to either the top or the bottom. The factory default is set to top. To change this, simply use the arrow keys on the DVR which also represent the channel 1-4 keys (These are the top four buttons). Use the up and down arrow keys to make your selection.



: Press  or  to move the cursor to the left or right.

: Press  or  to change the value.

These keys are located at the top left row of keys (same keys as channel 1-4).

Network Setting Menu

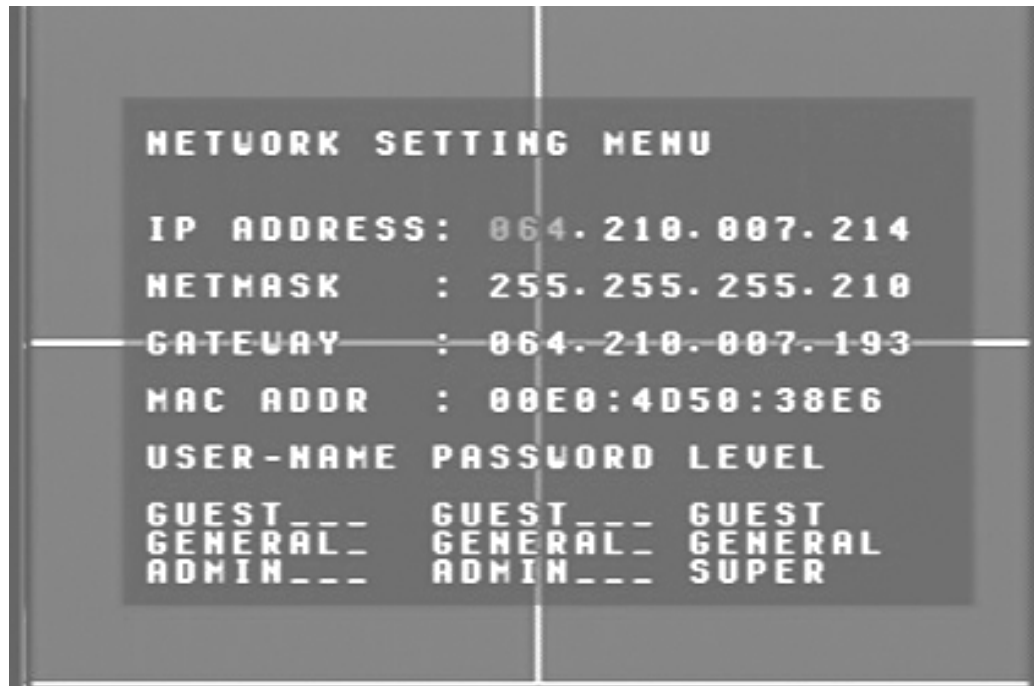

Diagram 10

Diagram ten is a screen shot of the Network Setting Menu. This menu is for setting up the configuration for networking to the DVR. Please refer to the Networking Chapter of this manual to fully understand how to setup your network for this DVR. In the Network Setting Menu the following fields are defined as follows:

- IP Address: This field is to set a static IP Address for the DVR. A static IP address is an IP address whose value does not change. EverFocus suggest using a static IP address. If your Internet provider does not offer a static IP address you have the option to use a dynamic IP address. For Example: A Test IP address given to the machine by our engineers is 192.168.010.010.
 - Please Note: The Addresses in the machine are for our own testing you must apply your own addresses to comply with your network. Refer to Networking Chapter for more details.

To change this, simply use the arrow keys on the DVR which also represent the channel 1-4 keys (These are the top four buttons). Use the up and down arrow keys to make your selection.

- Net mask: This field is to set the subnet mask for your network so as the DVR will be recognized within the network. Example: 255.255.255.000 To change this, simply use the arrow keys on the DVR which also represent the channel 1-4 keys (These are the top four buttons). Use the up and down arrow keys to make your selection.
- Gateway: This field is to set the gateway for your network so the DVR will be recognized within the network. An example of this is provided within the DVR we use to test the machine within our own network. To change this, simply use the arrow keys on the DVR which also represent the channel 1-4 keys (These are the top four buttons). Use the up and down arrow keys to make your selection.
- Mac Address: This field is for those Internet service providers or Network administrators who require a MAC address of the network card of our DVR. This option can not be changed.
- User-Name Password Level: This category is to set up the users that will log into the network. Please remember that this portion of the Network setting menu is set up in column format.
 - To change the any of the presets to a more user defined name simple use the arrow keys on the DVR which also represent the channel 1-4 keys (These are the top four buttons). Use the up and down arrow keys to make your selection.
 - Example:

USER-NAME	Password	Level
admin	admin	super
Changed to Adam	Everfocus	super
 - Please remember there are only three different levels guest, general, and super.
 - “Admin” and “general” – can view live/playback video
 - “Guest” – can only view live.



: Press or to move the cursor to the left or right.

: Press or to change the value.

These keys are located at the top left row of keys (same keys as channel 1-4).

Sequence Setting Menu

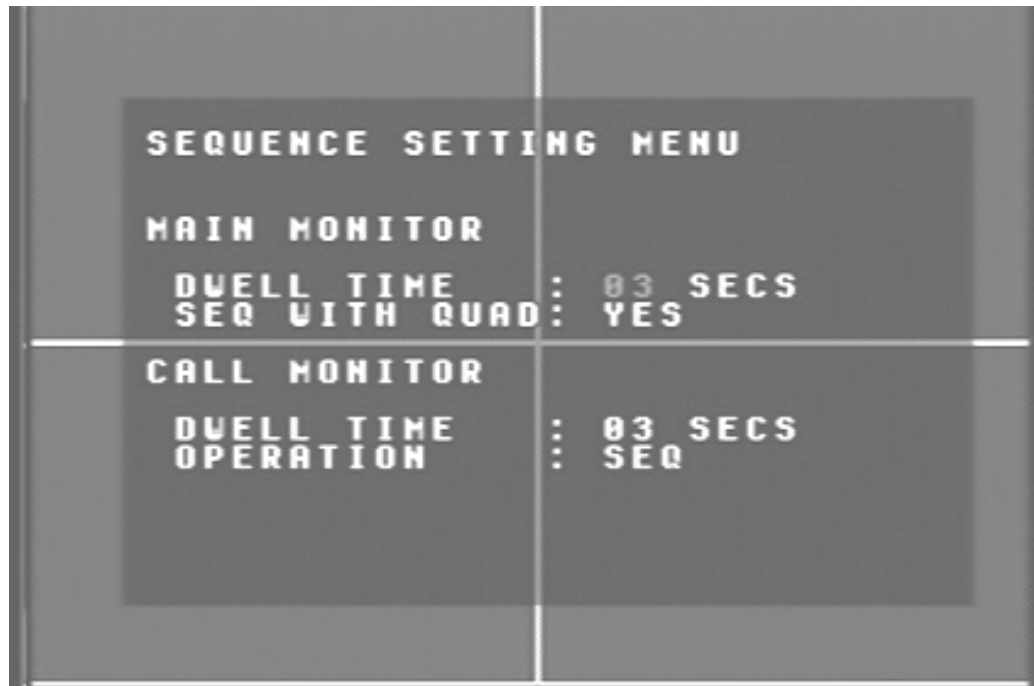



Diagram 11



Diagram eleven is a screen shot of the Sequence Setting Menu. This menu is for setting up the way in which video is sequenced through the main monitor and call monitor outputs. In the Sequence Setting Menu the following fields are defined as follows:

- Main Monitor: This field is to set the sequence for the main monitor output.
 - Dwell Time: This field represents the rate at which the cameras will sequence on the main monitor. The dwell time for the auto sequence can be set from 0 to 99 seconds. To change this, simply use the arrow keys on the DVR which also represent the channel 1-4 keys (These are the top four buttons). Use the up and down arrow keys to make your selection.
 - Seq with Quad: This field is to turn on or off the quad screen when the auto sequence mode is on. The default is set to yes. To turn it off simple change to no. To change this, simply use the arrow keys on the DVR which also represent the channel 1-4 keys (These are the top four buttons). Use the up and down arrow keys to make your selection.

- Call Monitor: This field is to set the sequence for the call monitor output.
 - Dwell Time: This field represents the rate at which the cameras will sequence on the call monitor. The dwell time for the auto sequence can be set from 0 to 99 seconds. To change this, simply use the arrow keys on the DVR which also represent the channel 1-4 keys (These are the top four buttons). Use the up and down arrow keys to make your selection.
 - Operation: This field is to select from camera 1 to 4 for the sequence screen. The default is set to CH1. To change this, simply use the arrow keys on the DVR which also represent the channel 1-4 keys (These are the top four buttons). Use the up and down arrow keys to make your selection.
 - Please Note: If an alarm occurs call monitor will display that particular camera automatically.



: Press  or  to move the cursor to the left or right.

: Press  or  to change the value.

These keys are located at the top left row of keys (same keys as channel 1-4).

RS232/RS485 Setting Menu



Diagram 12

Diagram twelve is a screen shot of the RS232/RS485 Setting Menu. This menu is for setting up a connection from the digital recorder to a computer to transfer instructions or information using the HyperTerminal program in Windows. In the RS232/RS485 Setting Menu the following fields are defined as follows:

RS232:

- **RS232 Baud Rate:** This field is to set the speed at which is used to transmit instruction or information through the RS232 port on the DVR. There are six different speeds, 1200 BPS, 2400 BPS, 4800 BPS, 9600 BPS, 19200 BPS, and 3840 BPS. The default setting from the factory is 9600 BPS. To change this, simply use the arrow keys on the DVR which also represent the channel 1-4 keys (These are the top four buttons). Use the up and down arrow keys to make your selection.
- **RS232 Stop Bit:** This field is to set the stop bit for the RS232 connection. There are two different stop bits, 1 or 2. The default in the DVR is set to 1. To change this, simply use the arrow keys on the DVR which also represent the channel 1-4 keys (These are the top four buttons). Use the up and down arrow keys to make your selection.



- RS232 Parity: This field is to select the parity level at which you will be connected. You can choose between None, Odd, or Even parity levels. Default is set to None. To change this, simply use the arrow keys on the DVR which also represent the channel 1-4 keys (These are the top four buttons). Use the up and down arrow keys to make your selection.
- RS232 Data Bit: This field is the data bit at which you will be transferring. There are two settings for this option: 8 or 7. The default is set to 8. To change this, simply use the arrow keys on the DVR which also represent the channel 1-4 keys (These are the top four buttons). Use the up and down arrow keys to make your selection.



RS485:

- RS485 Baud Rate: This field is to set the speed at which is used to transmit instruction or information through the RS485 port on the DVR. There are six different speeds, 1200 BPS, 2400 BPS, 4800 BPS, 9600 BPS, 19200 BPS, and 3840 BPS. The default setting from the factory is 9600 BPS. To change this, simply use the arrow keys on the DVR which also represent the channel 1-4 keys (These are the top four buttons). Use the up and down arrow keys to make your selection.
- RS485 Stop Bit: This field is to set the stop bit for the RS485 connection. There are two different stop bits, 1 or 2. The default in the DVR is set to 1. To change this, simply use the arrow keys on the DVR which also represent the channel 1-4 keys (These are the top four buttons). Use the up and down arrow keys to make your selection.
- RS485 Parity: This field is to select the parity level at which you will be connected. You can choose between None, Odd, or Even parity levels. Default is set to None. To change this, simply use the arrow keys on the DVR which also represent the channel 1-4 keys (These are the top four buttons). Use the up and down arrow keys to make your selection.
- RS485 Data Bit: This field is the data bit at which you will be transferring. There are two settings for this option: 8 or 7. The default is set to 8. To change this, simply use the arrow keys on the DVR which also represent the channel 1-4 keys (These are the top four buttons). Use the up and down arrow keys to make your selection.

- RS232/RS485 ID: This entry is used to assign each device its own ID code if more than one unit is used through the RS232/RS485 connection. There are two ID codes for the DVR: 001 or 002. The default is set to 001. To change this, simply use the arrow keys on the DVR which also represent the channel 1-4 keys (These are the top four buttons). Use the up and down arrow keys to make your selection.



: Press  or  to move the cursor to the left or right.

: Press  or  to change the value.

These keys are located at the top left row of keys (same keys as channel 1-4).

Motion Record Setting Menu

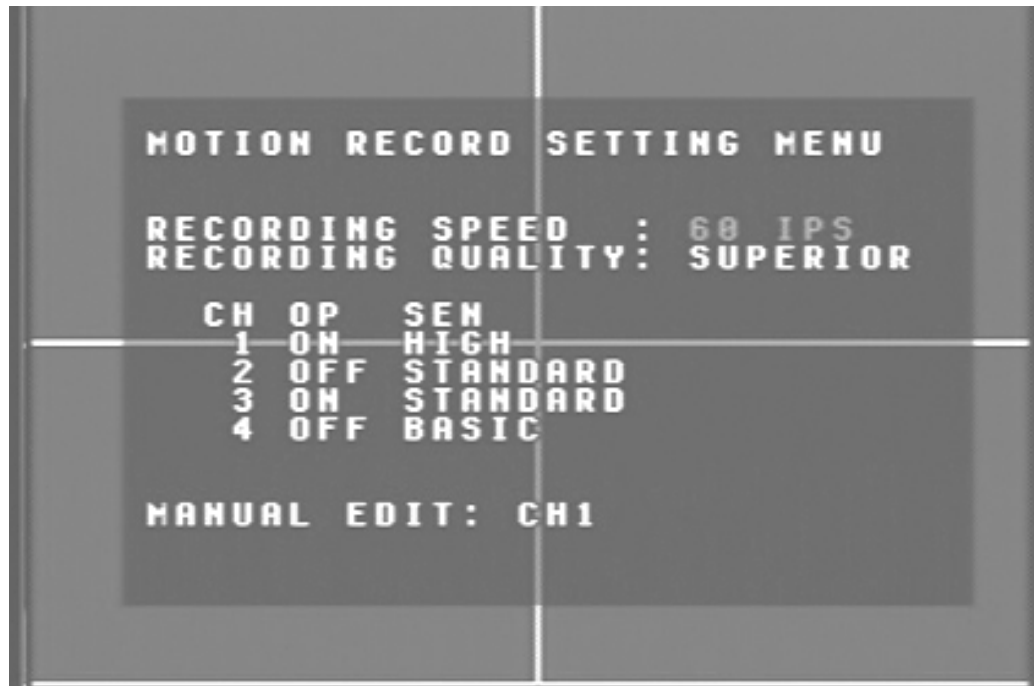

Diagram 13

Diagram thirteen is a screen shot of the Motion Record Setting Menu. This menu is for setting up the digital recorder for motion recording. In the Motion Record Setting Menu the following fields are defined as follows:

- Recording Speed: This field represents the speed at which the recorder will be recording when motion is detected. To change this, simply use the arrow keys on the DVR which also represent the channel 1-4 keys (These are the top four buttons). Use the up and down arrow keys to make your selection.
 - Please Note: See Appendix B to find the appropriate speed to fit your recording needs.
- Quality: This field is for setting up video recording quality, this item lets you set the quality of the video picture by selecting a compression rate.

There are six quality levels for recording:

- Lower : 15KB
- Low : 19KB
- Basic : 23KB



- Standard : 27KB
- High : 31KB
- Superior : 35KB



To change this, simply use the arrow keys on the DVR which also represent the channel 1-4 keys (These are the top four buttons). Use the up and down arrow keys to make your selection.

- CH: This field represents the camera channels 1 through 4.
- OP: This field is to set the option of turning motion on or off. If OP is turned on the DVR will respond by recording when motion occurs. If OP is turned off the DVR will not record when motion occurs. To change this, simply use the arrow keys on the DVR which also represent the channel 1-4 keys (These are the top four buttons). Use the up and down arrow keys to make your selection.
- SEN: This entry signifies the sensitivity to pick up motion for each camera. There are four different sensitivity levels that can be used, High, Standard, Basic, Low. The default setting is standard. To change this, simply use the arrow keys on the DVR which also represent the channel 1-4 keys (These are the top four buttons). Use the up and down arrow keys to make your selection.
- Manual Edit: This field represents manual editing of each camera for motion. To change this, simply use the arrow keys on the DVR which also represent the channel 1-4 keys (These are the top four buttons). Use the up and down arrow keys to make your selection. Once you have chosen the channel you would like to manually edit, press the ENTER button. This will bring you to a new screen.

- Diagram 14 shows a screen shot of the manually edit screen. Use the arrow buttons to move through the squares. Initially all the squares are pink in color signifying that these squares are set up to pick up motion. To deselect a square simply move over the square and press the ENTER button. Diagram 15 shows another screen shot of a manually edited screen after editing has been accomplished.
- To exit this screen after you have finished editing simply press the MENU button.



: Press  or  to move the cursor to the left or right.

: Press  or  to change the value.

These keys are located at the top left row of keys (same keys as channel 1-4).

System Setting Menu

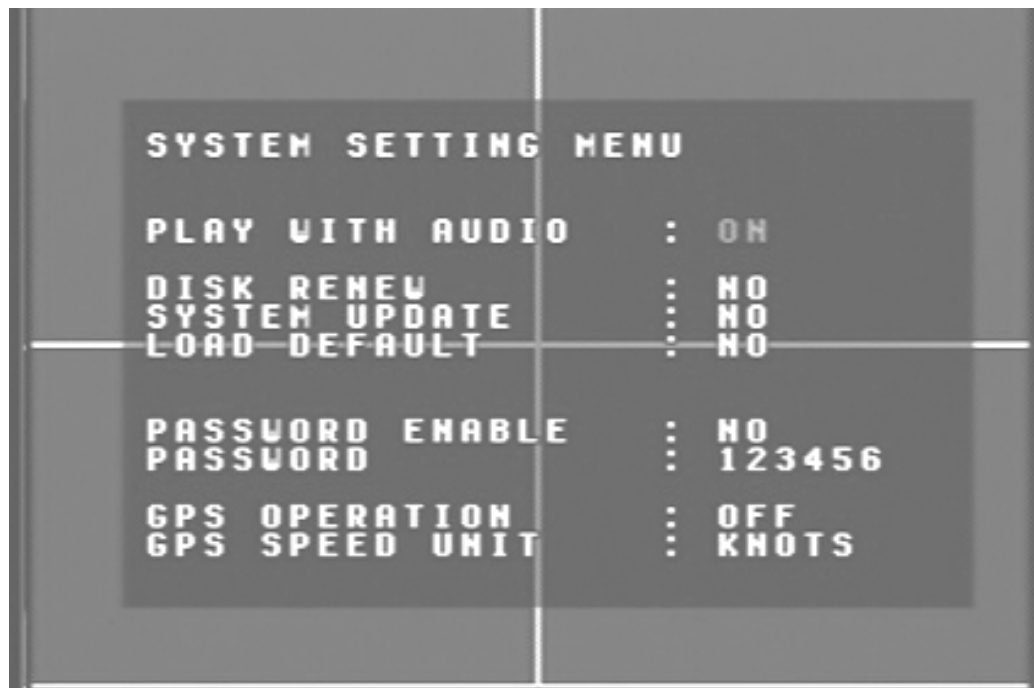

Diagram 16

Diagram sixteen is a screen shot of the System Setting Menu. This menu is for setting up any additional options and restoring defaults to the digital recorder. In the System Setting Menu the following fields are defined as follows:

- **Play with Audio:** This field is to turn on audio while playing video which contains prerecorded audio. This option can be turned on or off. The default is set to on. To change this, simply use the arrow keys on the DVR which also represent the channel 1-4 keys (These are the top four buttons). Use the up and down arrow keys to make your selection.
- **Disk Renew:** This entry is to format the Hard Drive. Initially it is set to No. To format the Hard Drive simply use the arrow buttons to change this option to yes. This will bring up a second dialog which asks you if you want to do a disk renew again. Use the arrow buttons to select yes and press the enter button.
 - **Please Note:** See Disk Renew Chapter for more details and diagrams.
- **System Update:** This field is to update the firmware in the system. Initially it is set to No. To Update the system simply use the arrow buttons to change this option to yes. This will bring up a second dialog which asks

you if you want to do a system update again. Use the arrow buttons to select yes and press the enter button.

- Please Note: See System Update Chapter for more details and diagrams. Also after the system has updated successfully, be sure to cycle the power to the digital recorder by turning the power off and then back on.
- Load Default: This entry is to set the DVR back to factory settings. Please remember if you are having difficulties with your DVR we suggest restoring the defaults before calling Tech support. Initially Load defaults is set to No. To Load the defaults simply use the arrow buttons to change this option to yes. This will bring up a second dialog which asks you if you want to do a load defaults again. Use the arrow buttons to select yes and press the enter button.
 - Please Note: See Load Defaults Chapter for more details and diagrams. Also after the system has loaded the defaults successfully, be sure to cycle the power to the digital recorder by turning the power off and then back on.
- Password Enable: This field is to turn the password function on or off. The default is set to No. If you would like to enable the password change this option to yes. To change this, simply use the arrow keys on the DVR which also represent the channel 1-4 keys (These are the top four buttons). Use the up and down arrow keys to make your selection.
- Password: This field is the password for the system when the password is enabled. The password supports up to 6 characters. The available alphanumeric characters are:

- 0 to 9, A to Z, and /() . - * & @ : ”

To change this, simply use the arrow keys on the DVR which also represent the channel 1-4 keys (These are the top four buttons). Use the up and down arrow keys to make your selection.

- Please Note: For More information please refer to Password Chapter.



: Press ◀ or ▶ to move the cursor to the left or right.

: Press ▲ or ▼ to change the value.

These keys are located at the top left row of keys (same keys as channel 1-4).

Recording Overview

Before continuing please be sure to have reviewed DVR Menu Setup (Chapter 3). You are now ready to begin setting up the machine for normal recording. This chapter will show you how to setup the recorder for basic recording.

Basic Recording Setup

- Assuming you have completed the setup options in Chapter 1 and 2. Log into the DVR menu by pressing the Menu button.

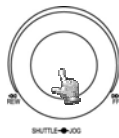

Turning the jog dial clockwise or counter clockwise will allow you to scroll through the different menu setup option pages.

- Once You Reach the Normal Record Setting Menu (See Page 19) change the Recording speed and quality that best fits your application.
 - Please Note: See Appendix B to find the appropriate speed to fit your recording needs.
- Once you have completed the previous step log out of the menu and hit the record button.
- To view the operating display (diagram 18), press the Display button.



Diagram 18

- To stop recording simply press the Stop button.
 - Please Note: When the Hard Drive is full, the DVR will either stop recording automatically or overwrite from the beginning of the hard drive. This is all dependent on what was set in the normal record setting (see page 19).

Timer Recording Setup

- Assuming you have completed the setup options in Chapter 1 and 2. Log into the DVR menu by pressing the Menu button.



Turning the jog dial clockwise or counter clockwise will allow you to scroll through the different menu setup option pages.

- Once You Reach the Normal Record Setting Menu (See Page 19) change the Recording speed and quality that best fits your application.
 - Please Note: See Appendix B to find the appropriate speed to fit your recording needs.
- Use the jog dial after completing the previous step and go to Timer Record Setting menu (See Page 17). Setup a timer for your application and exit the menu by pressing the Menu button. Once you have exited the menu the DVR will go into record mode.
- To view the operating display (diagram 19), press the Display button.

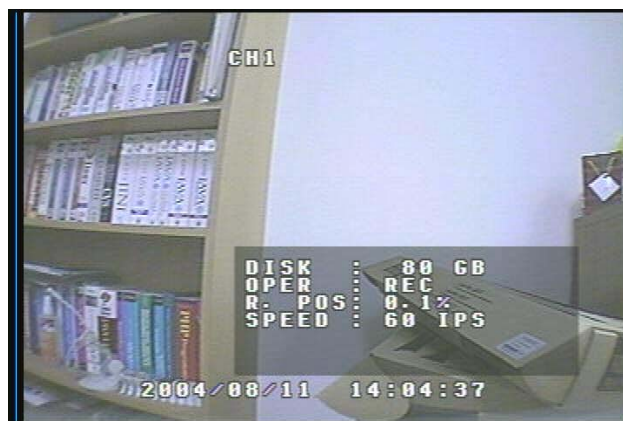

Diagram 19

- To stop recording simply press the Stop button.

- Please Note: When the Hard Drive is full, the DVR will either stop recording automatically or overwrite from the beginning of the hard drive. This is all dependent on what was set in the normal record setting (see page 19).

Motion Recording Setup

- Assuming you have completed the setup options in Chapter 1 and 2. Log into the DVR menu by pressing the Menu button.

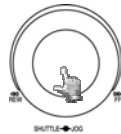

Turning the jog dial clockwise or counter clockwise will allow you to scroll through the different menu setup option pages.

- Once You Reach the Normal Record Setting Menu (See Page 19) change the Recording speed to 0.2 IPS and quality that best fits your application.
- Use the jog dial after completing the previous step and go to Motion Record Setting menu (See Page 35). Change the Recording speed and quality that best fits your application.
 - Please Note: See Appendix B to find the appropriate speed to fit your recording needs.
- Exit the menu by pressing the Menu button. Once you have exited the menu if motion is occurring the DVR will go into record mode. Make sure you press the record button if not recording or if after motion has stopped the record light has gone off.
 - Please Note: If you see the Record Light going on and off you are not recording properly in motion. This will eat up your hard drive space. To remedy this problem simply press the record button when the light goes off to stay in record mode continuously.
- To view the operating display (diagram 20), press the Display button.

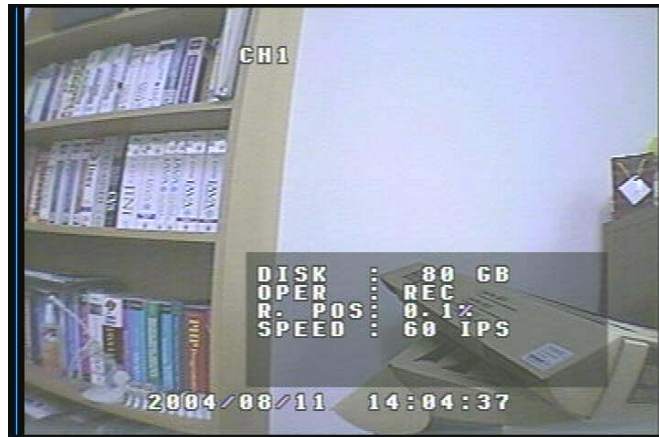

Diagram 20

- To stop recording simply press the Stop button.
 - Please Note: When the Hard Drive is full, the DVR will either stop recording automatically or overwrite from the beginning of the hard drive. This is all dependent on what was set in the normal record setting (see page 19).

Alarm Recording Setup

- Assuming you have completed the setup options in Chapter 1 and 2. Log into the DVR menu by pressing the Menu button.



Turning the jog dial clockwise or counter clockwise will allow you to scroll through the different menu setup option pages.

- Once You Reach the Alarm Record Setting Menu (See Page 21) change the Recording speed and quality that best fits your application.
 - Please Note: See Appendix B to find the appropriate speed to fit your recording needs.
- Exit the menu by pressing the Menu button. Once you have exited the menu if an alarm occurs the DVR will go into record mode.
- To view the operating display (diagram 21), press the Display button.

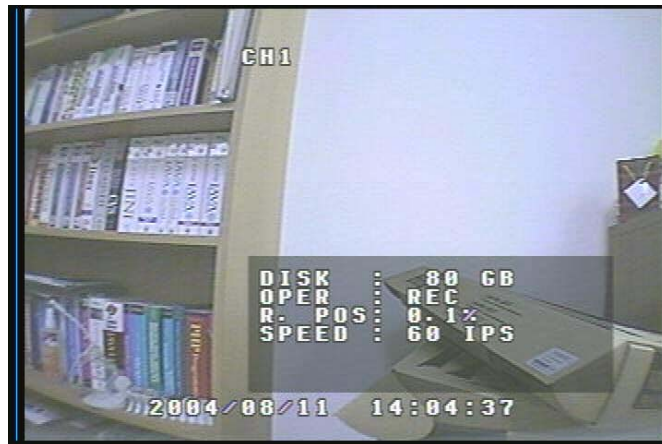

Diagram 21

- To stop recording simply press the Stop button.
 - Please Note: When the Hard Drive is full, the DVR will either stop recording automatically or overwrite from the beginning of the hard drive. This is all dependent on what was set in the normal record setting (see page 19).

Playback Overview

Before continuing please be sure to have reviewed DVR Menu Setup (Chapter 3). You are now ready to begin setting up the machine for playback. This chapter will show you how to setup the recorder for basic playback.

Basic Playback

- Assuming you have completed the setup options in Chapter 1 through 4. If you are in Record mode hit the stop button to stop recording.
- If the menu pops up when you press the stop button. This usually means you have either the DVR is in Timer record or Motion record. Log into the DVR menu by pressing the Menu button. Go to Either Timer Setting Menu or Motion Record Setting menu and turn them off.
- Once you have stopped any type of recording on the DVR you are ready to do playback.
- Pressing the play button will set the recorder into playback mode and play the last segment recorded.
- If you Press the Rev play button it will play the last known segment in reverse mode.
- At any point if you wish to fast forward or rewind while playing back simply use the shuttle dial to do so. The speed will be shown on the corner of the screen. << Or >> 2, 4, 6, 8, 16, 32, 600X.
- If you want to do a slow playback press the pause button anytime during playback. Then simply turn the shuttle clockwise or counter clockwise depending if you want to do a slow forward or slow rewind. The speed will be shown on the corner of the screen. << Or >> 1/2, 1/4, 1/6, 1/8, 1/16, 1/32.
- If you want to go frame by frame while playing something back. Press the pause button and use the jog dial to advance to the next image. Turning the jog dial counter clockwise will go to the previous still image.

Search Playback

1. Segment List Playback

- Assuming you have completed the setup options in Chapter 1 through 4. If you are in Record mode hit the stop button to stop recording.
- If the menu pops up when you press the stop button. This usually means you have either the DVR is in Timer record or Motion record. Log into the DVR menu by pressing the Menu button. Go to Either Timer Setting Menu or Motion Record Setting menu and turn them off.
- Once you have stopped any type of recording on the DVR you are ready to do playback.
- Press the search button to enter the search menu. (See Diagram 22)



Diagram 22

- Use the up and down arrow keys to select segment list and press the enter key.
- Diagram 23 illustrates what the segment list may look like. Use the up and down arrow keys to choose a segment you want to playback and press the enter key. This in turn will start playing the segment you chose.



Diagram 23

- To stop playing back press the stop key.

2. Alarm List Playback

- Assuming you have completed the setup options in Chapter 1 through 4. If you are in Record mode hit the stop button to stop recording.
- If the menu pops up when you press the stop button. This usually means you have either the DVR is in Timer record or Motion record. Log into the DVR menu by pressing the Menu button. Go to Either Timer Setting Menu or Motion Record Setting menu and turn them off.
- Once you have stopped any type of recording on the DVR you are ready to do playback.
- Press the search button to enter the search menu. (See Diagram 24)

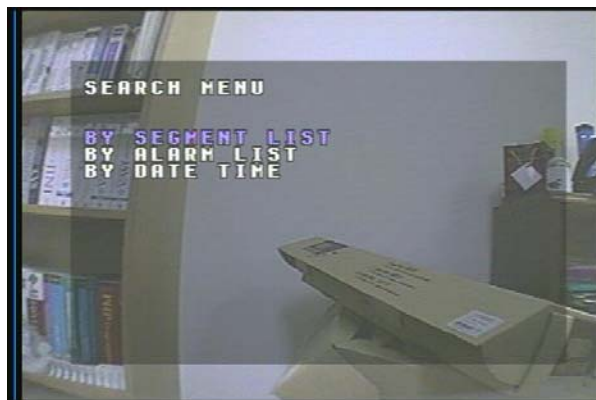

Diagram 24

- Use the up and down arrow keys to select alarm list and press the enter key.
 - Please Note: If the alarm list is empty it is because there are no alarms or motion being recorded.
- Diagram 25 illustrates what the alarm list may look like. Use the up and down arrow keys to choose a segment you want to playback and press the enter key. This in turn will start playing the segment you chose.

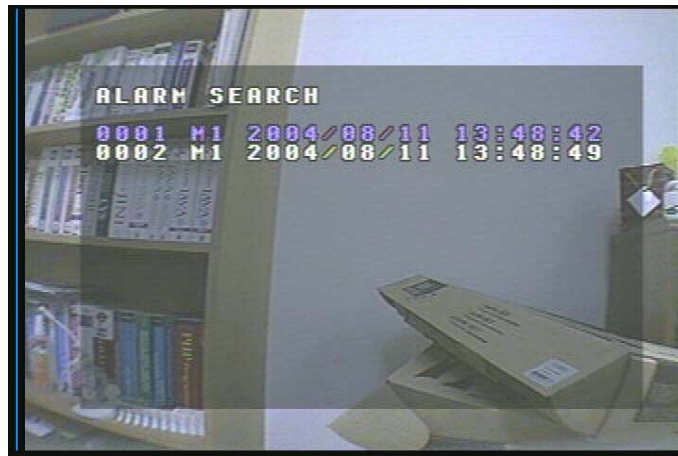

Diagram 25

- To stop playing back press the stop key.

3. Date/Time Playback

- Assuming you have completed the setup options in Chapter 1 through 4. If you are in Record mode hit the stop button to stop recording.
- If the menu pops up when you press the stop button. This usually means you have either the DVR is in Timer record or Motion record. Log into the DVR menu by pressing the Menu button. Go to Either Timer Setting Menu or Motion Record Setting menu and turn them off.
- Once you have stopped any type of recording on the DVR you are ready to do playback.
- Press the search button to enter the search menu. (See Diagram 26)

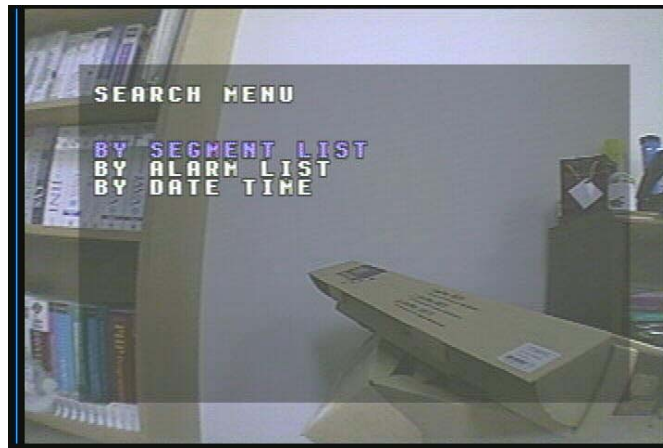

Diagram 26

- Use the up and down arrow keys to select Date/Time and press the enter key.
- Diagram 27 illustrates what the Date/Time field may look like. Use the up and down arrow keys to enter a date and time you want to playback, highlight search, and press the enter key. This in turn will start playing the segment you chose.

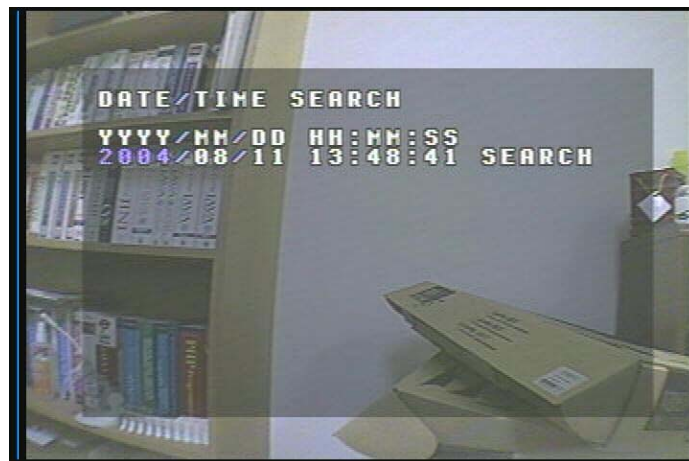

Diagram 27

- To stop playing back press the stop key.

Copying Video

Before continuing please be sure to have reviewed the preceding chapters. You are now ready to copy an image or video from the DVR. This chapter will show you how to copy a still image or movie from the recorder.

- Please Note: Lexar Compact Flash Cards are not compatible with Everfocus digital recorders. Everfocus suggests using **Sandisk** or **Kingston** Compact Flash Cards.
- Insert the **Sandisk** or **Kingston** Compact Flash Cards into the Compact Flash card slot on the front panel of the DVR. When inserting the Compact Flash card, make sure the direction of insertion is correct.

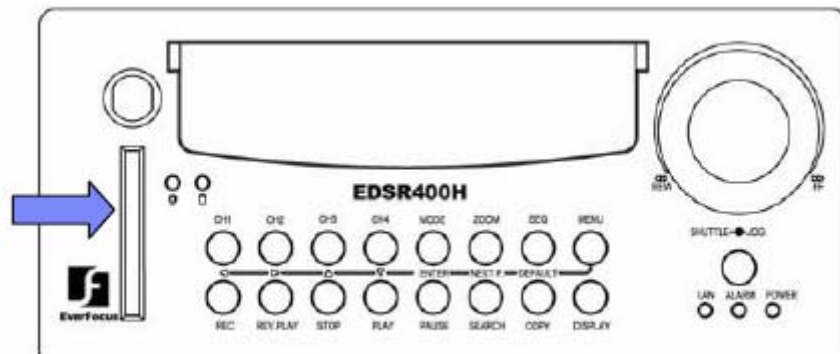

Still Image Copy

- First step is to play the video you want to archive. Please refer to chapter 5 to for playing back video.
- Once you are in playback mode press the pause button. You may use the jog dial to go back or forward to select the image you wish to copy.
- Once you have the image you want copied on the screen press the copy button.

- You will then see “Copying ...” on the screen while it is copying to the flash card. When it has finished copying will disappear from the screen.



Diagram 28



Diagram 29

- The image on the Compact flash card will be stored as a jpeg file.

Copy as a MOV File

- First step is to play the video you want to archive. Please refer to chapter 5 to for playing back video.
- Once you are in playback mode, select the camera and have the portion of the video you wish to copy. Then press the copy button.

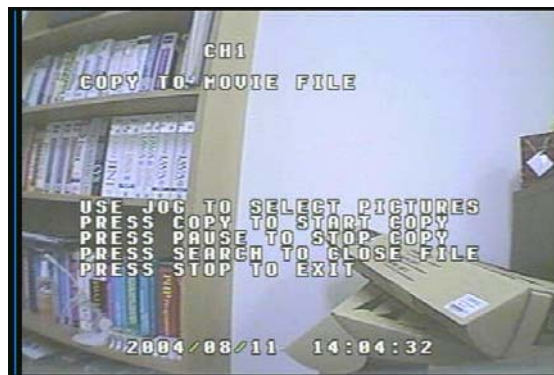

Diagram 30

- You will see a screen similar to diagram 30 when you have pressed the copy button. This on screen menu will help you finish the copying process. At this point to continue recording you would press the copy button again. Once you have the video you want to stop copying just press the pause button.

- To exit press the stop button.
- The video is now stored on the Compact flash card as a MOV file. This type of file can be played using QuickTime video player. You can download this program for free from www.quicktime.com.

Other Archiving Methods

- Other methods of archiving may include Powercon software which can be found on our ftp site (<ftp://64.210.7.210>). You may also use our Hard Drive reader (model number: EPR100) which you can hook to the usb port of a computer. The third option to archive would be to use our DVD recorder (model number: VPDVD100).

Viewing a Copied File

- First step is to play the video or image you have stored on the Compact Flash card is to take the Compact Flash card and insert it into the Compact Flash Reader which came with your digital recorder. Insert the other end of the Flash card reader into the USB port of your computer.
- Open up My computer in windows and you will notice a new drive has been added to the computer. This is the Compact flash card. To view the files simply click on the drive to open it and you will see the files you archived.
- The video stored on the Compact flash card is a MOV file. This type of file can be played using QuickTime video player. You can download this program for free from www.quicktime.com.

Audio Overview

This chapter will try to give you details on how to setup audio on the DVR. Before we begin the process of connecting audio to your digital recorder we should have the following items. A Line level microphone (RCA input) and speakers for playback output (RCA).

You will not be able to hear audio live unless an audio processor is looped through or placed between the mic and the DVR.

- You will not hear audio through the TCP/IP connection.
- You can not archive any audio recording.
- You can not record using motion or an alarm with audio recording.
- You must set the normal record speed between 60 ips to 1 ips.

Recommended audio processor:

Louroe Base Station ATR-1.

How to Upgrade Firmware on the DVR?

This chapter will try to give you a detailed instruction on how to upgrade the DVR. This will be a helpful in completing the upgrading process.

- Please go to <ftp://64.210.7.210> and go to DVR Firmware upgrade folder. Then click on the folder that represents you're the model number of your DVR.
- Copy the .HEX to CF card using the Compact Flash reader that came with your DVR (from a computer).
- Please Note: Lexar Compact Flash Cards are not compatible with Everfocus digital recorders. Everfocus suggests using **Sandisk** or **Kingston** Compact Flash Cards.
- Insert the **Sandisk** or **Kingston** Compact Flash Cards into the Compact Flash card slot on the front panel of the DVR. When inserting the Compact Flash card, make sure the direction of insertion is correct.
- If you are in Record mode hit the stop button to stop recording.
- If the menu pops up when you press the stop button. This usually means you have either the DVR is in Timer record or Motion record. Log into the DVR menu by pressing the Menu button. Go to Either Timer Setting Menu or Motion Record Setting menu and turn them off.
- Once you have stopped any type of recording on the DVR you are ready to upgrade.
- Press the menu button and use the Jog Dial to go to System menu (See page 39).
- Using the enter button to navigate in the menu. Highlight System Upgrade turn NO to YES (use jog wheel to select).

- Highlight YES again and press enter (use jog wheel to select).
- Next to System Upgrade you will notice it say "Reading...then Programming...then Success..."
- Once you have read success log out of the menu by pressing the menu button twice. Then turn the power on the DVR off and turn it back on.

Networking Overview

This chapter will try to give you a detailed instruction on how to network the DVR. Before we begin the process of networking your digital recorder we should have a working knowledge of what a network is and how it works. This will be a helpful in completing the networking process.

Introduction to TCP/IP

TCP/IP is the suite of protocols used by the Internet and most LANs (Local Area Networks) throughout the world. In TCP/IP, every host (computer or other communications device) that is connected to the network has a unique IP address. By doing this you are giving your device a unique address similar to the address of your house. An IP address is composed of four octets (numbers in the range of 0 to 255) separated by decimal points. The IP address is used to uniquely identify a host or computer on the LAN. For example, a computer with the hostname Workstation could have an IP address of 192.168.1.127.

You should avoid giving two or more computers the same IP address by using the range of IP addresses that are reserved for private, local area networks; this range of IP addresses usually begins with the octets 192.168. The first three octets of an IP address should be the same for all computers in the local area network. For example, if a total of 253 computers exist in a single LAN, the IP addresses could be assigned starting with 192.168.1. x , where x represents a number in the range of 2 to 254.

Subnet Masks

Each host in a LAN has a subnet mask. The *subnet mask* is an octet that uses the number 255 to represent the network address portion of the IP address and a zero to identify the host portion of the address. For example, the subnet mask 255.255.255.0 is used by each host to determine which LAN or class it belongs to. The zero at the end of the subnet mask represents a unique host within that network. Basically the subnet mask represents the city you live in for your home address, but in this case you are stating the network you belong too.

Gateway Address

Each host in a LAN has a gateway. A gateway address is composed of four octets (numbers in the range of 0 to 255) separated by decimal points. The gateway address is used to uniquely identify a host or computer on the LAN which assigns the IP addresses to your network. For example, a Linksys router has an IP address of 192.168.1.1. If you were using this type of router within your LAN, then your gateway would be the IP address of the Linksys router. The reason this would be your gateway is because the Linksys is assigning the IP addresses for your network therefore the Linksys would be the gateway to your network. This is similar to the zip code of your address.

Virtual Ports

A **port number** represents an endpoint or "channel" for network communications. Port numbers allow different applications on the same computer to utilize network resources without interfering with each other. Port numbers most commonly appear in network programming, particularly socket programming. Sometimes, though, port numbers are made visible to the casual user. For example, some Web sites a person visits on the Internet use a URL like the following:

```
http://www.everfocus.com:8100/
```

In this example, the number 8100 refers to the port number used by the Web browser to connect to the Web server. Normally, a Web site uses port number 80 and this number need not be included with the URL (although it can be). In IP networking, port numbers can theoretically range from 0 to 65535. Most popular network applications, though, use port numbers at the low end of the range (such as 80 for HTTP). This could be similar to the front door of your house. Without the door to the house being open you could not enter it. This is the same case with ports on a network. If the ports for a specific IP address are not open then you could not gain access to that IP address or what it is addressing.

Please Note: The term port also refers to several other aspects of network technology. A port can refer to a physical connection point for peripheral devices such as serial, parallel, and USB ports. The term port also refers to certain Ethernet connection points, such as those on a hub, switch, or router.

Pre-Installation

Before we begin with the installation we must ask ourselves a few questions in order to figure out where to begin with networking our DVR's.

Do you have Hi-speed Internet? _____

There are many types of high speed Internet available. Three commonly used ones are T1, Cable, and DSL (in order of speed).

- Please Note: Everfocus suggests having a minimum upload speed of 256KBps. This can be addressed by the Internet Service Provider.

Who is your Internet provider? _____

- Please confirm that your internet service provider that our upload speed is at least 256KBps.

What type of modem/router do you have? _____

Modem/router model name/ #

The modem/router was either installed by your Internet service provider or purchased by you to establish a connection to the Internet. A router is installed to allow multiple computers to access the Internet through the same external IP address. It in turn assigns different internal IP addresses to local computers for this specific purpose.

Do you have a static IP address? _____

A Static IP address means you use the same IP address every time you log on to the Internet. With a static IP address, other Internet users always know the identity of your computer and can easily connect with it. That way, you can host a website, email server, or other type of server connection. Everfocus suggest using a static IP address. If your Internet provider does not offer a static IP address you have the option to use a dynamic IP address. This will be explained in more detail later on in the chapter.

Do you have a dynamic IP address? _____

A Dynamic IP address means your IP address changes each time you make a connection to the Internet. We recommend asking your Internet service provider for a Static IP address. If this is not a possibility, you may purchase a router (we suggest a Linksys or D-link router) which supports

DDNS. DDNS is a Dynamic Domain Name Server, a service that provides a central (public) database where DNS information can be stored and retrieved. It allows those using a dynamic IP address to be registered centrally so users can connect to it by name.

What type of DVR are you installing? _____

Everfocus EDR series: EDR 400, 1600 or 1680

Everfocus EDSR series: EDSR 110, 400H, 400M, 400, 900, or 1600

What Type of Network Connection do you have?

Everfocus DVR's can operate using three distinct types of networking connections.

1. **Simple One to One Connection:** A simple one to one connection is the most simple network connection. Basically it is a connection between a Computer and Another Computer or in this case a DVR using a cross-over cable. (See page on how to install this type of connection)
2. **Direct High Speed Modem Connection:** A direct high speed modem connection is a network connection from the modem directly to a computer or in this case the DVR. (See page on how to install this type of connection)
3. **Router or LAN Connection –** A local area network connection either requires a router or a pre-existing LAN connection. Typically this type of connection is the most commonly used application. A router allows multiple computers and DVR's to access each other as well as the Internet. It assigns different internal IP addresses to the computers.

Simple One to One Connection

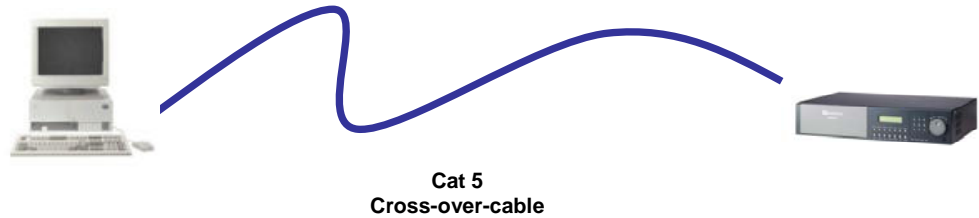

Crossover Ethernet Cable Pin outs:

The Diagram below shows the pin configurations for a cross over cable.

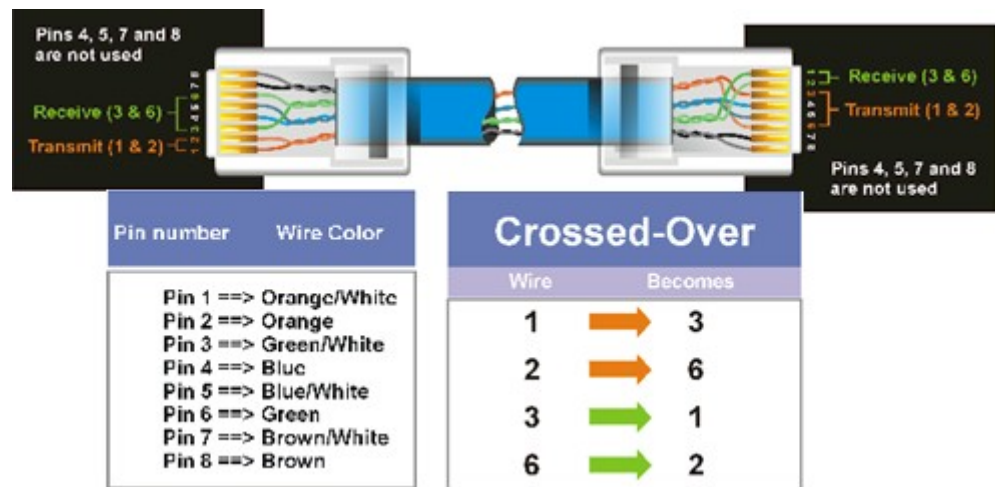

Diagram 31

Connection Procedure:

- The First step is to purchase or make a cross over cable. We recommend purchasing one if you have never made a cross over cable. Please remember you can not use a straight through network cable for this application
- Once you have a cross over cable plug one end into the LAN port on the back of the recorder and the other into the network card on the back of the computer.
- Now Log into the Everfocus DVR menu and using the jog dial from the previous chapter go to the Network Setting Menu. (See page 28 for more instructions)

- Assign an IP address of 192.168.001.003 to the DVR, a Subnet mask of 255.255.255.000, and a default gateway of 192.168.001.001.
- The next step is to get the computer onto the same network to do this you will need administrator access to your windows machine.
- To assign a static IP address in windows 2000/XP.

- Go to **Start**
- Double-click on **Control Panel**

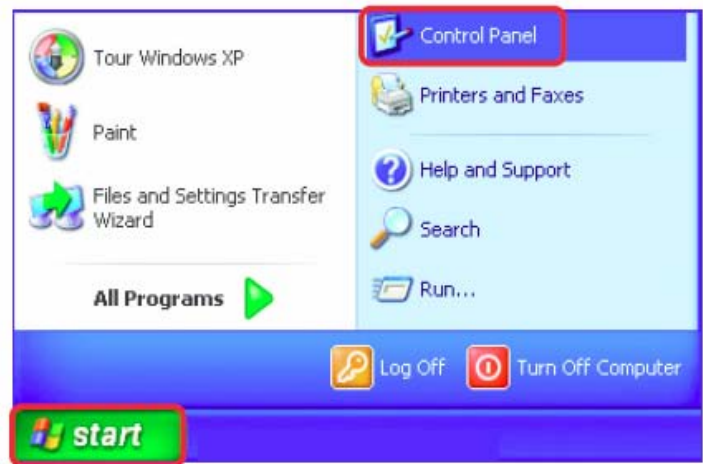

- Double-click on **Network Connections**

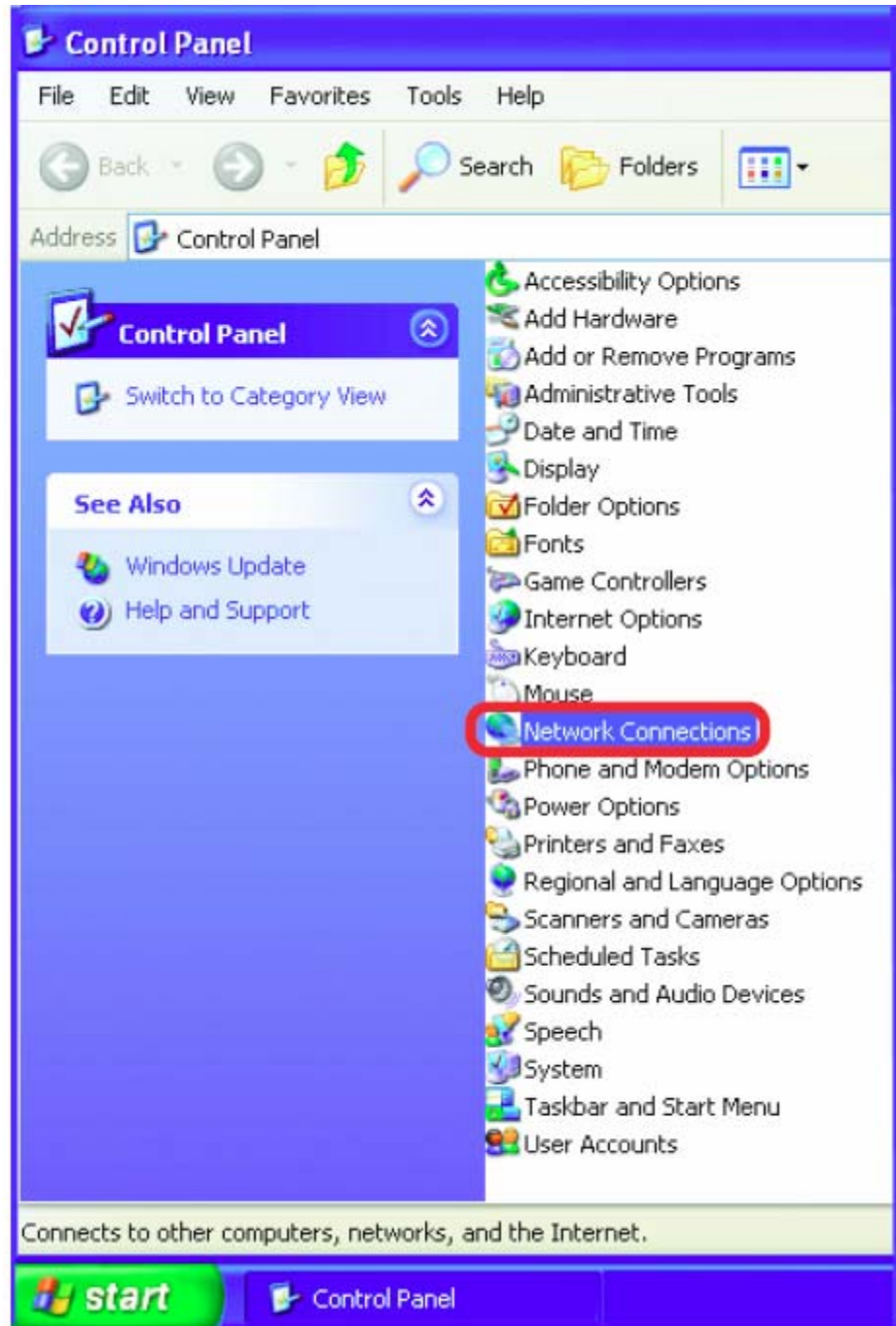

- Right-click on **Local Area Connections**

- Double-click on **Properties**

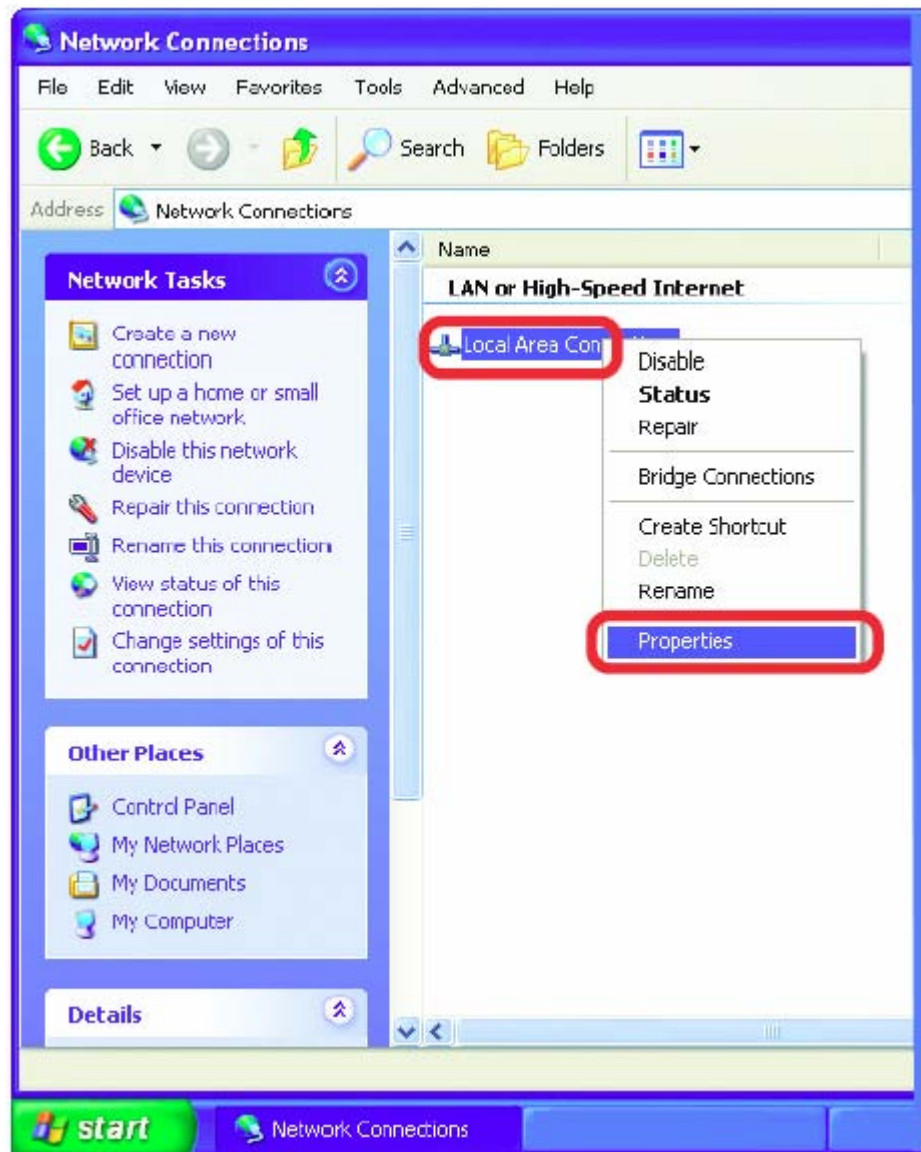

- Click on **Internet Protocol (TCP/IP)**
- Click **Properties**

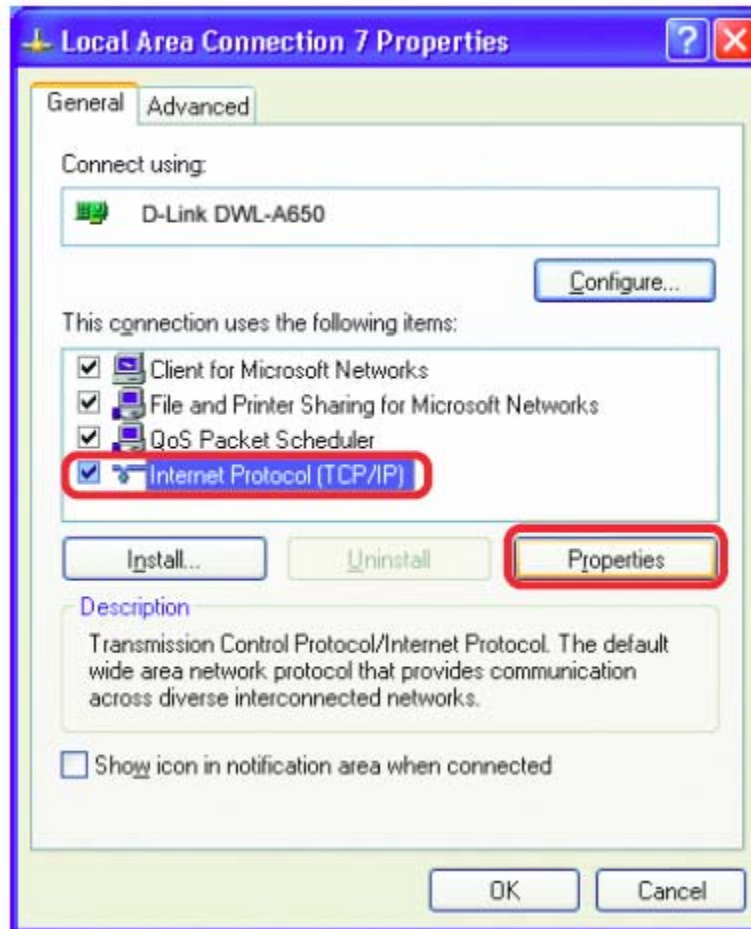

- Input your **IP address and subnet mask.** (The IP Addresses on your network must be within the same range.)



- Once you have reached this point click ok and restart both the computer and the digital recorder.
- To access the DVR from the computer simply open Internet Explorer and in the address bar type:

`http://192.168.1.3`

Direct High Speed Modem Connection

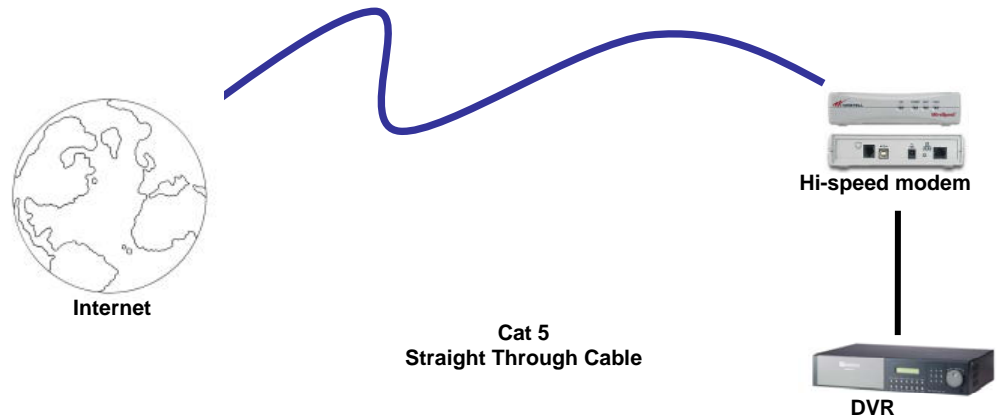

Straight Through Ethernet Cable Pin outs:

The Diagram below shows the pin configurations for a straight cable.

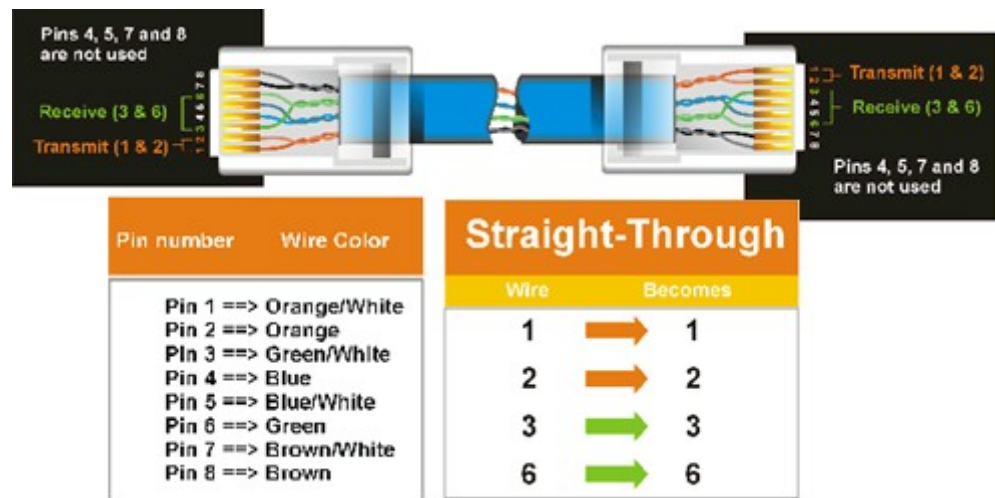

Diagram 32

Connection Procedure:

- The First step is to purchase or make a straight through cable. We recommend purchasing one if you have never made a straight through cable. Please remember you can not use a cross over network cable for this application
- Once you have a straight through cable plug one end into the LAN port on the back of the recorder and the other into the high speed modem.

- Now Log into the Everfocus DVR menu and using the jog dial from the previous chapter go to the Network Setting Menu. (See page 28 for more instructions)
- Assign the Static IP address which you obtained from the internet service provider to the DVR, the Subnet mask from the internet service provider to the DVR, and the default gateway of the internet service provider.
 - Please Note: If you have a dynamic IP address this type of connection will not work for you. You will need to purchase a router or ask your internet service provider for a static IP address. (Please refer to local area network connection checklist)
- Once you have reached this point click ok and restart both the computer and the digital recorder.
- To access the DVR from a computer simply open Internet Explorer and in the address bar type:

http:// and the IP address of your internet service provider.

Router or LAN Connection

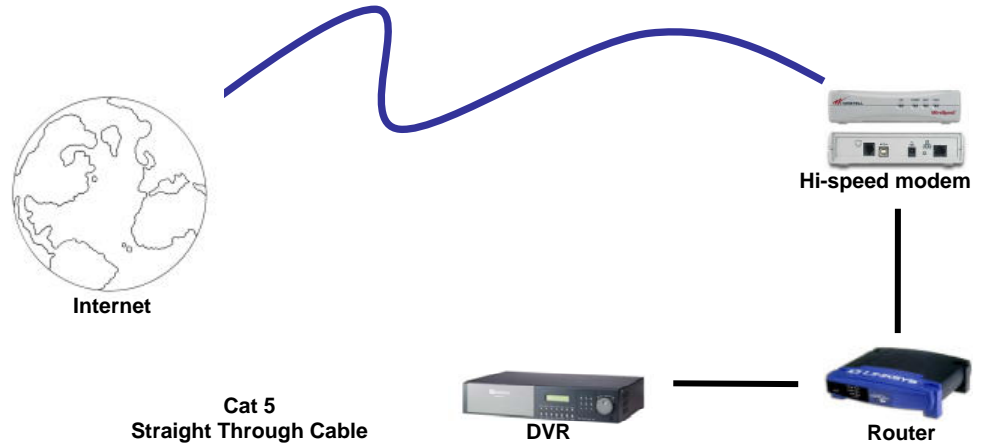

Straight Through Ethernet Cable Pin outs:

The Diagram below shows the pin configurations for a straight cable.

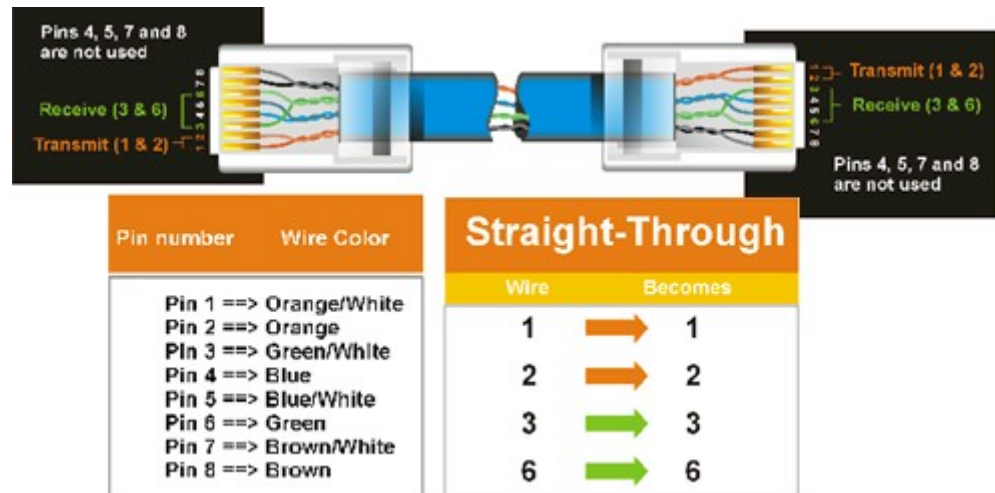

Diagram 33

Connection Procedure:

- The First step is to purchase or make a straight through cable. We recommend purchasing one if you have never made a straight through cable. Please remember you can not use a cross over network cable for this application

- Once you have a straight through cable plug one end into the LAN port on the back of the recorder and the other into the router.
- Now Log into the Everfocus DVR menu and using the jog dial from the previous chapter go to the Network Setting Menu. (See page 28 for more instructions)
- If you have a Linksys Router:
 - Assign an IP address of 192.168.001.050 to the DVR, a Subnet mask of 255.255.255.000, and a default gateway of 192.168.001.001.

If you have a D-Link Router:

- Assign an IP address of 192.168.000.050 to the DVR, a Subnet mask of 255.255.255.000, and a default gateway of 192.168.000.001.

If you have a pre-existing LAN:

- Go to a Computer on the pre-existing network and do the following:
 - Go to Start, then Run and type cmd and click on OK.
- Then hit enter, type ipconfig and press enter this will give you the information you will need.



```

C:\WINDOWS\system32\cmd.exe
Microsoft Windows XP [Version 5.1.2600]
(C) Copyright 1985-2001 Microsoft Corp.

C:\Documents and Settings\Arai>ipconfig

Windows IP Configuration

Ethernet adapter Local Area Connection:

    Connection-specific DNS Suffix  . :
    IP Address . . . . .                :
    Subnet Mask . . . . .               :
    Default Gateway . . . . .           :

C:\Documents and Settings\Arai>_
  
```

- Use the prior step to assign an IP address. For example, if you got the IP address from the computer of 192.168.002.101. Assign the DVR's IP address as 192.168.002.050. Now Copy the subnet mask and default gateway information you got from the prior step off the computer to the DVR.

- Please Note: Make sure the modem is in bridge mode. If your Internet Service Provider is BellSouth you will have a modem/router. BellSouth provides a Westell modem that includes a built-in router. You will need to disable the router functionality.
- The next step is to open ports within your router. Open virtual ports in the router (Log into the router using a PC)
 - EDR Ports to open: 80, 1111, 1600
 - EDSR Ports to open: 80, 1111, 2222, 3333, 4444, 6666
 - Please Note: If your Internet service provider blocks port 80 you may use a different port to access the DVR through the routers UPNP forwarding (Linksys feature) or Virtual Server (D-Link feature). This will be addressed in the next two chapters.
- If you have a Dynamic IP address and have open the ports simply go to Chapter 9 to Configure DDNS.
- Once you have reached this point and you have restarted the digital recorder.
- To access the DVR from a computer simply open Internet Explorer and in the address bar type:

http:// and the IP address of your internet service provider.

- Please Note: If your Internet service provider blocks port 80 you may use a different port to access the DVR through the routers UPNP forwarding (Linksys feature) or Virtual Server (D-Link feature). This will be addressed in the next two chapters.

Linksys Port Forwarding

This chapter will cover a few simple configurations for the Linksys router. Please understand we do not support this product and will not give tech support on it. If you need Technical support on this router you must call Linksys. This Chapter is to offer some help to the installer and end user nothing more.

To access the Web-based Utility, launch Internet Explorer or Netscape Navigator, and enter the Router's default IP address, **192.168.1.1**, in the *Address* field. Then, press **Enter**. A password request page will appear. (Non-Windows XP users will see a similar screen.) Leave the *User Name* field blank. The first time you open the Web-based Utility, use the default password **admin**. (You can set a new password from the Administration tab's *Management* screen.) Click the **OK** button to continue.



The first screen that appears displays the Setup tab. This allows you to change the Router's general settings. Change these settings as described here and click the **Save Settings** button to apply your changes or **Cancel Changes** to cancel your changes.

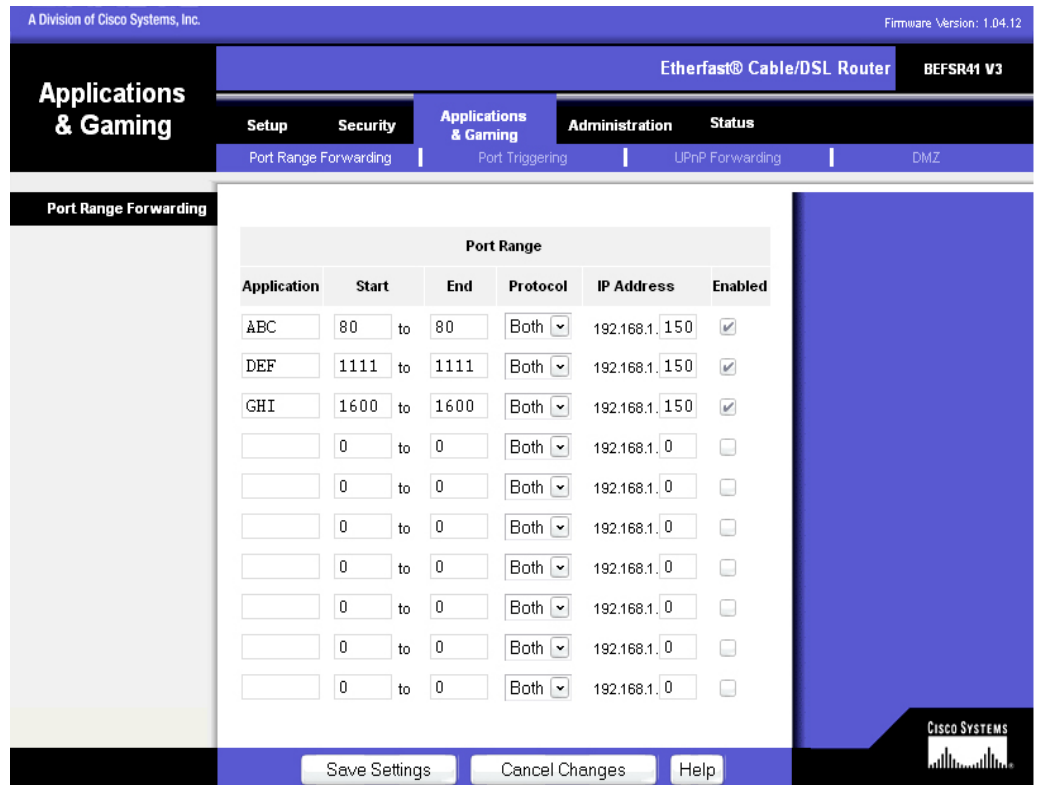

The Applications and Gaming Tab allows you to set up public services on your network, such as web servers, ftp servers, e-mail servers, or other specialized Internet applications. (Specialized Internet applications are any applications that use Internet access to perform functions such as videoconferencing or online gaming. Some Internet applications may not require any forwarding.)

To forward a port, enter the information on each line for the criteria required. Descriptions of each criteria are described here.

A Division of Cisco Systems, Inc. Firmware Version: 1.04.12

Etherfast® Cable/DSL Router BEFSR41 V3

Applications & Gaming

Setup Security **Applications & Gaming** Administration Status

Port Range Forwarding | Port Triggering | UPnP Forwarding | DMZ

Port Range Forwarding

Port Range					
Application	Start	End	Protocol	IP Address	Enabled
ABC	80	to 80	Both	192.168.1.150	<input checked="" type="checkbox"/>
DEF	1111	to 1111	Both	192.168.1.150	<input checked="" type="checkbox"/>
GHI	1600	to 1600	Both	192.168.1.150	<input checked="" type="checkbox"/>
	0	to 0	Both	192.168.1.0	<input type="checkbox"/>
	0	to 0	Both	192.168.1.0	<input type="checkbox"/>
	0	to 0	Both	192.168.1.0	<input type="checkbox"/>
	0	to 0	Both	192.168.1.0	<input type="checkbox"/>
	0	to 0	Both	192.168.1.0	<input type="checkbox"/>
	0	to 0	Both	192.168.1.0	<input type="checkbox"/>
	0	to 0	Both	192.168.1.0	<input type="checkbox"/>
	0	to 0	Both	192.168.1.0	<input type="checkbox"/>

Cisco Systems

Save Settings Cancel Changes Help

Application - In this field, enter the name you wish to give the application. Each name can be up to 12 characters.

Start/End - This is the port range. Enter the number that starts the port range under **Start** and the number that ends the range under **End**.

Protocol - Enter the protocol used for this application, either **TCP** or **UDP**, or **Both**.

IP Address - For each application, enter the IP Address of the PC running the specific application.

Enable - Click the **Enable** checkbox to enable port forwarding for the relevant application.

Change these settings as described here and click the **Save Settings** button to apply your changes or **Cancel Changes** to cancel your changes.

Example:

DVR	80 to 80	Both	192.168.1.50	Enable
DVR	1111 to 1111	Both	192.168.1.50	Enable
DVR	2222 to 2222	Both	192.168.1.50	Enable

DVR	3333 to 3333	Both	192.168.1.50	Enable
DVR	4444 to 4444	Both	192.168.1.50	Enable
DVR	6666 to 6666	Both	192.168.1.50	Enable
DVR	1600 to 1600	Both	192.168.1.50	Enable

➤ The next step is to open ports within your router. Open virtual ports in the router.

- EDR Ports to open: 80, 1111, 1600
- EDSR Ports to open: 80, 1111, 2222, 3333, 4444, 6666

➤ If your Internet Service Provider Blocks port 80. Simply do the following:

Clicking the UPnP Forwarding button on the Port Range Forwarding tab will display the UPnP Forwarding tab. The UPnP Forwarding tab displays preset application settings as well as options for customization of port services for other applications.

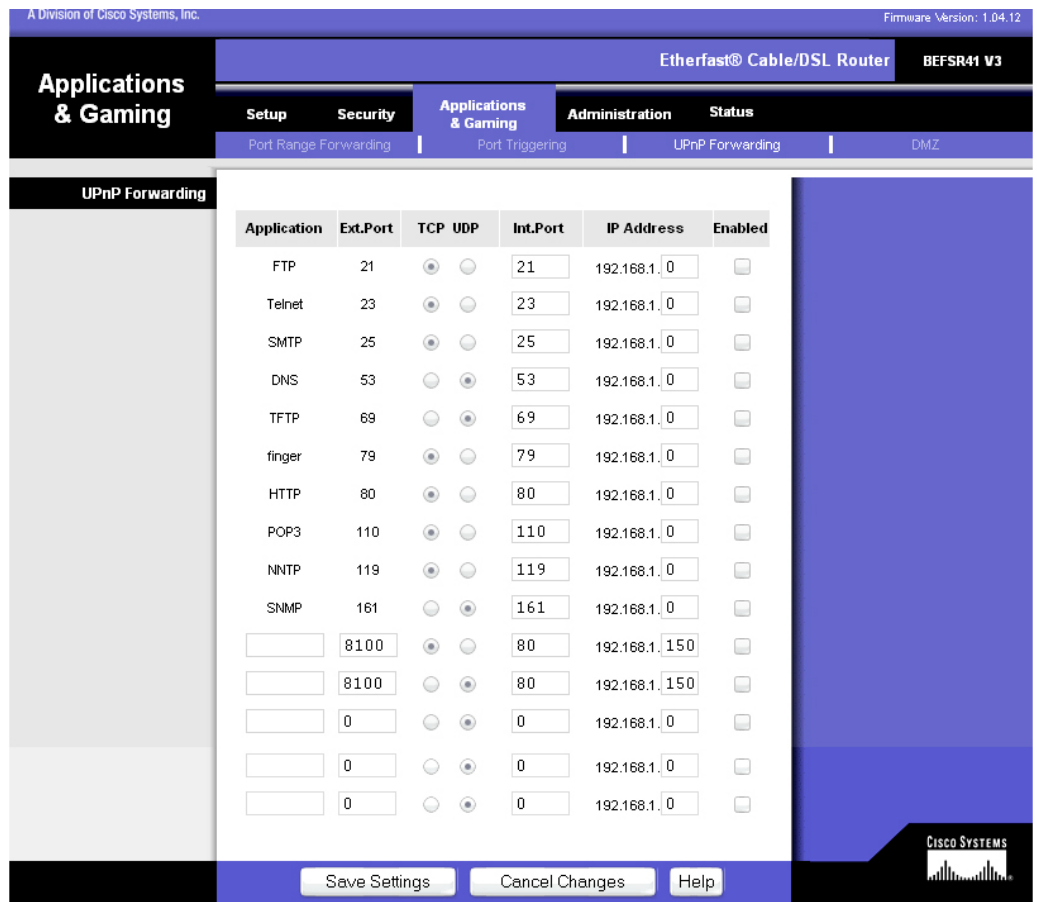

To add a server using UPnP Forwarding:

1. Enter the **name** of the application in the appropriate Application Name field.
2. Next to the name of the application, enter the **number** of the external port used by the server in the Ext. Port column. Check with the Internet application software documentation for more information.
3. On the same line, select the protocol **UDP** or **TCP**.
4. Enter the **number** of the internal port used by the server in the Int. Port column. Check with the Internet application software documentation for more information.
5. Enter the IP address of the server that you want the Internet users to be able to access.
6. Check the **Enable** box to enable the services you have defined. UPnP Forwarding will not function if the **Enable** button is left unchecked. This is disabled (unchecked) by default.

Example:

DVR	8100	TCP	80	192.168.1.50	Enable
DVR	8100	UDP	80	192.168.1.50	Enable

- To access the DVR from a computer simply open Internet Explorer and in the address bar type:

http:// IP address of your internet service provider: 8100

Dynamic DNS

The Router offers a Dynamic Domain Name System (DDNS) feature. DDNS lets you assign a fixed host and domain name to a dynamic Internet IP address. It is useful when you are hosting your own website, FTP server, or other server behind the Router. Before you can use this feature, you need to sign up for DDNS service at www.dyndns.org, DDNS service providers.

DDNS Service - From this pull-down menu, enter the DDNS service with which you have membership.

User Name - Enter the User Name for your DDNS account.

Password - Enter the Password for your DDNS account.

Host Name - This is the DDNS URL assigned by the DDNS service.

Internet IP Address - This is the Router's current IP Address as seen on the Internet.

Status - This displays the status of the DDNS connection.

Change these settings as described here and click the **Save Settings** button to apply your changes or **Cancel Changes** to cancel your changes.

The screenshot shows the Linksys web interface for configuring DDNS. The page title is "Etherfast® Cable/DSL Router" and the model is "BEFSR41 V3". The firmware version is "1.04.12". The navigation menu includes "Setup", "Security", "Applications & Gaming", "Administration", and "Status". Under "Setup", there are sub-menus for "Basic Setup", "DDNS", "MAC Address Clone", and "Advanced Routing". The "DDNS" sub-menu is selected, and the "DynDNS.org" service is chosen from a pull-down menu. The configuration fields are as follows:

DDNS Service:	DynDNS.org
User Name:	<input type="text"/>
Password:	<input type="password"/>
Host Name:	<input type="text"/>
Internet IP Address:	129.44.56.193
Status:	DDNS server is currently closed.

At the bottom of the page, there are three buttons: "Save Settings", "Cancel Changes", and "Help". The Cisco Systems logo is visible in the bottom right corner.

D-Link Port Forwarding

This chapter will cover a few simple configurations for the D-Link router. Please understand we do not support this product and will not give tech support on it. If you need Technical support on this router you must call D-Link. This Chapter is to offer some help to the installer and end user nothing more.

Whenever you want to configure your network or the DI-624, you can access the Configuration Menu by opening the web-browser and typing in the IP Address of the DI-624. The DI-624 default IP Address is shown at right:

- Open the web browser
- Type in the **IP Address** of the Router (<http://192.168.0.1>)

Note: if you have changed the default IP Address assigned to the DI-624, make sure to enter the correct IP Address.

- Type **admin** in the **User Name** field
- Leave the **Password** blank
- Click **OK**

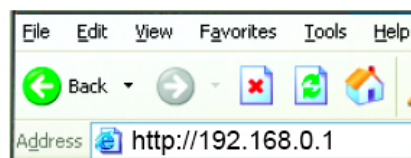

- The next step is to open ports within your router. Go to Virtual Server in the router.

D-Link
Building Networks for People

AirPlus Xtreme G™
High-Speed 2.4GHz Wireless Router

DI-624

Virtual Server

Applications

Filters

Firewall

DMZ

Performance

Home **Advanced** Tools Status Help

Virtual Server
Virtual Server is used to allow Internet users access to LAN services.

Enabled Disabled

Name

Private IP

Protocol Type

Private Port

Public Port

Schedule Always

From time : AM to : AM

day to

Virtual Servers List

Name	Private IP	Protocol	Schedule	Apply	Cancel	Help
<input type="checkbox"/> Virtual Server FTP	0.0.0.0	IP (0) 21/21	always	<input type="button" value="Apply"/>	<input type="button" value="Cancel"/>	<input type="button" value="Help"/>
<input type="checkbox"/> Virtual Server HTTP	0.0.0.0	IP (0) 80/80	always	<input type="button" value="Apply"/>	<input type="button" value="Cancel"/>	<input type="button" value="Help"/>

Example1:

Protocol Type - The protocol used for the virtual service.

Public Port - The port number on the WAN (Wide Area Network) side that will be used to access the virtual service.

Private Port - The port number of the service used by the Private IP computer.

Schedule - The schedule of time when the virtual service will be enabled.

The schedule may be set to **Always**, which will allow the particular service to always be enabled. If it is set to **Time**, select the time frame for the service to be enabled. If the system time is outside of the scheduled time, the service will be disabled.

Virtual Server - Select **Enabled** or **Disabled**

Name - Enter the name referencing the virtual service

Private IP - The server computer in the LAN (Local Area Network) that will be providing the virtual services. If you have a Web server that you wanted Internet users to access at all times, you would need to enable it. Web (HTTP) server is on LAN (Local Area Network) computer

192.168.0.50 HTTP uses port 80, TCP and UDP.

Name: DVR
Private IP: 192.168.0.50
Protocol Type: Both
Private Port: 80
Public Port: 80
Schedule: always

➤ The next step is to open ports within your router. Open virtual ports in the router.

- EDR Ports to open: 80, 1111, 1600
- EDSR Ports to open: 80, 1111, 2222, 3333, 4444, 6666

➤ If your Internet Service Provider Blocks port 80. Simply do the following:
192.168.0.50 HTTP uses port 80, TCP and UDP.

Name: DVR
Private IP: 192.168.0.50
Protocol Type: Both
Private Port: 80
Public Port: 8100
Schedule: always

➤ To access the DVR from a computer simply open Internet Explorer and in the address bar type:

http:// IP address of your internet service provider: 8100

Dynamic DNS

Dynamic Domain Name System is a method of keeping a domain name linked to a changing IP Address. This is a useful feature since many computers do not use a static IP address.

- To setup Dynamic DNS simple go to Tools and the Misc. At the bottom of the screen you will be able to enable DynDNS.
- Once you have enabled it enter the server address of DynDNS.org:
members.dyndns.org
- Then enter the hostname you created with DynDNS.org
Example: Everfocus.homeip.net
- Then enter the username and password you use to log into DynDNS.org



D-Link
Building Networks for People



**AirPlus
XTREME G™**

High-Speed 2.4GHz Wireless Router

DI-624



- Admin
- Time
- System
- Firmware
- Misc.
- Cable Test

Home
Advanced
Tools
Status

Ping Test
Ping Test is used to send "Ping" packets to test if a computer is on the Internet.

Host Name or IP address

Restart Device
Reboots the DI-624.

Block WAN Ping
When you "Block WAN Ping", you are causing the public WAN IP address on the 624 to not respond to ping commands. Pinging public WAN IP addresses is a common method used by hackers to test whether your WAN IP address is valid.

Discard PING from WAN side Enabled Disabled

UPNP Settings

Enabled Disabled

Gaming Mode

Enabled Disabled

VPN Pass-Through
Allows VPN connections to work through the DI-624.

PPTP Enabled Disabled

IPSec Enabled Disabled

Dynamic DNS

DDNS Enabled Disabled

Server Address

Host Name

Username

Password

DDNS

This chapter will cover a few simple configurations for setting up DDNS. Please understand we do not support this product and will not give tech support on it. If you need Technical support on DDNS you must call Linksys or D-Link. This Chapter is to offer some help to the installer and end user nothing more.

Creating a DDNS Account

- The first step is to open Internet Explorer and in the address bar type:

<http://www.dyndns.org>

- The next step is to register with dyndns.org by clicking on sign up now.

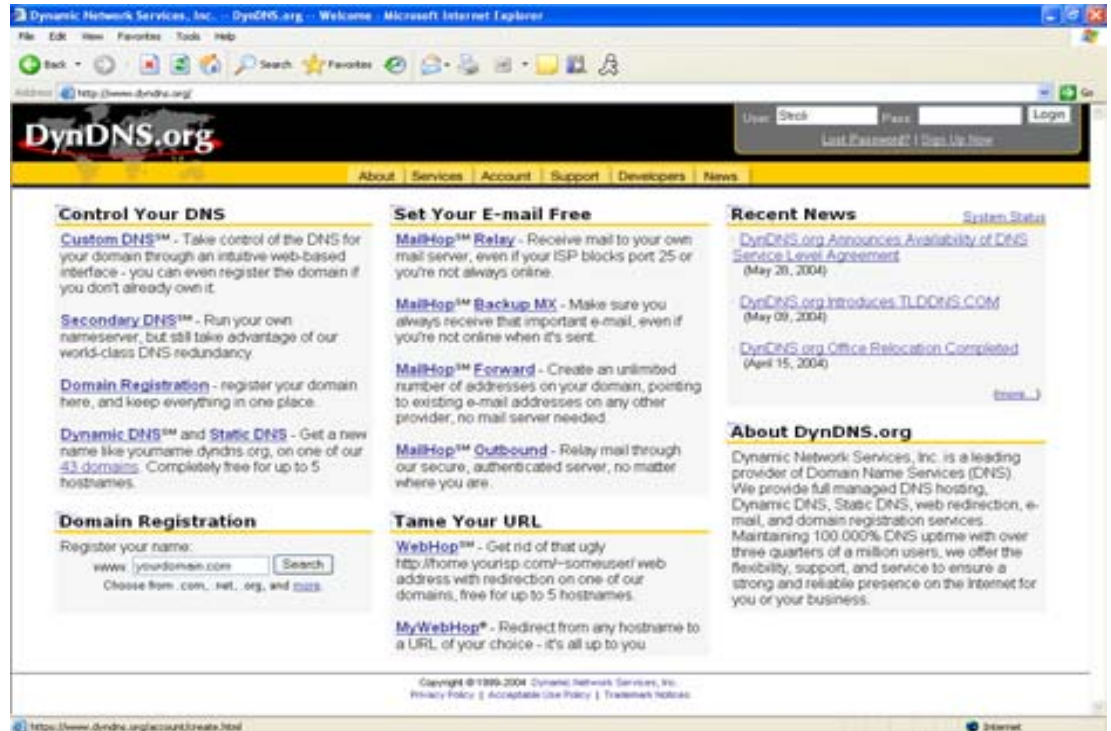

- This is where you file out the information DynDNS requires. You will then receive an email to confirm your account once you confirm you will login into DynDNS.org.
- After you have logged in click on click on the account tab and the click on Add Host link right next to Dynamic DNS.



- The next step is to add a host name with an extension.
Example: Everfocus.homeip.net
- The IP address should already be entered for you. All you have to do is click add host and you are done registering DDNS.
- You may refer to the previous two chapters to set up DDNS within your router.

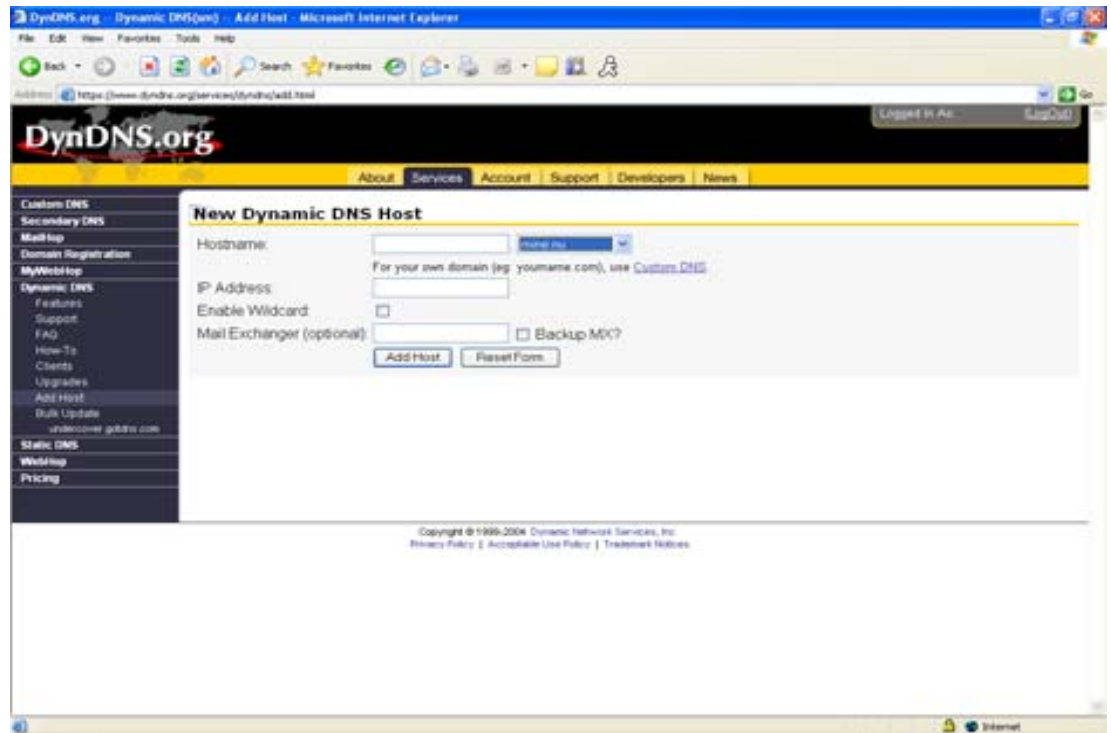

- To access the DVR from a computer simply open Internet Explorer and in the address bar type:

`http:// The DDNS you created example everfocu.homeip.net`

Chapter 13

Viewing through Internet Explorer

- To access the DVR from a computer simply open Internet Explorer and in the address bar type:

http:// (LAN or IP address of your internet service provider)

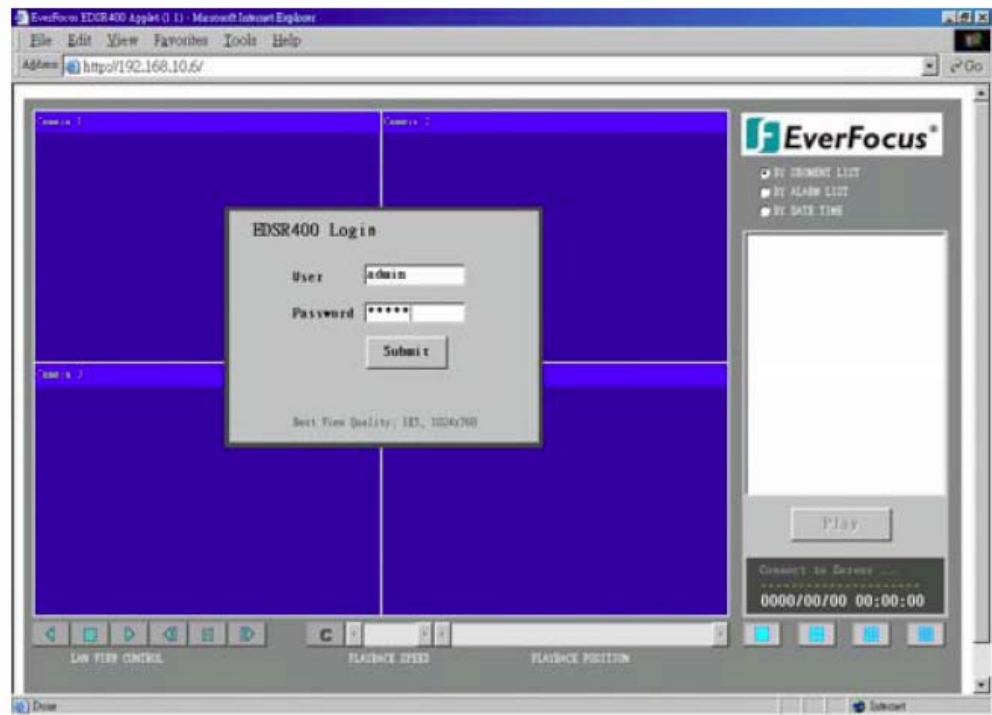







- The digital video login page will appear on the screen similar to the one shown above.
- User must enter a user name and password to access the recorder. You can find your user name and password in the Network setting menu of your DVR.
- The Default user name and password are admin and admin.

➤ Then click on the submit button and you will be logged into your recorder.

Main Screen



The followings are a brief description for each of the icons.

- ①  **REV. PLAY** : Reverses Video display
- ②  **STOP** : Press this key to stop Video display..
- ③  **PLAY**: Playing back the Video display.
- ④  **Step Forward** the Video display.
- ⑤  **Step Backward** the Video display
- ⑥  **PAUSE**: Press this key to pause the Video display.
- ⑦  **Control Mode**: This key will switch user to direct remote control mode.

Note: **C** Control Mode which only allow use with access level “Super” user..

- ⑧ Control for Playback Video Speed
- ⑨ Control for Playback Position
- ⑩ The system allows up to 3 ways playback video, by SEGMENT,ALARM LIST and DATE TIME.



(playback by segment list)

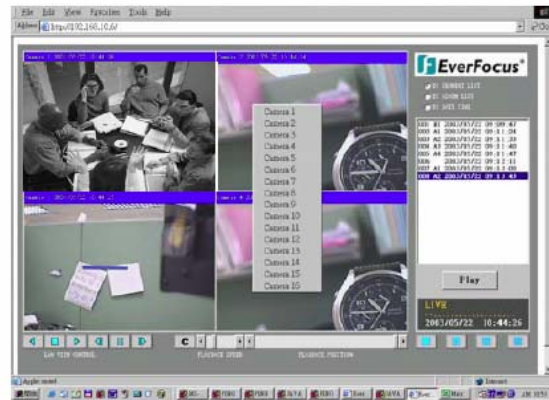

(playback by alarm list)

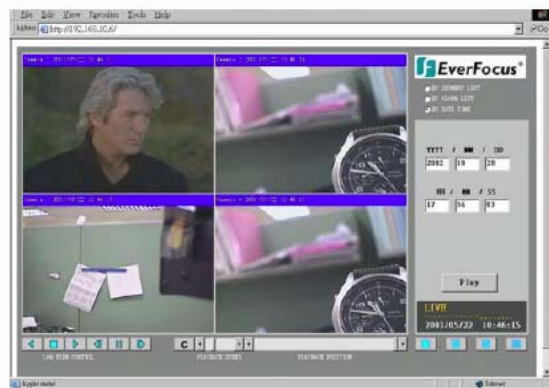

(playback by Date time)

- ⑪ All available segments are shown in the list. Click to select and highlight.
 - ⑫ Click to playback selected video segment.
 - ⑬ Current connection and playback status is shown along with date and time.
 - ⑭ Full screen view.
 - ⑮ Quad screen view
 - ⑯ Nine split screen view
 - ⑰ Sixteen split screen view
 - ⑱ A pop-up menu to select camera to view will be shown by pressing right mouse button.
*15,16,17,18 function are available with limited MUX.
- Please Note: If any icon is grayed, it means that particular function is not accessible.

Chapter
14

Interface Specifications

RS232

This Digital Video Recorder may be controlled by a computer or a terminal via the standard D-SUB 9-pin RS-232 connector.

- D-SUB 9-pin connector specifications:

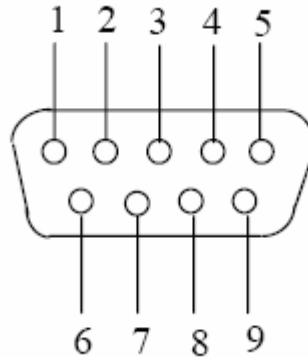

- The pin assignment of the 9-pin D-SUB connector

Digital Video Recorder			HOST	
PIN #	NAME		PIN #	NAME
1	NOT CONNECTED		1	NOT CONNECTED
2	TXD	→	2	RXD
3	RXD	←	3	TXD
4	NOT CONNECTED		4	NOT CONNECTED
5	GROUND	—	5	GROUND
6	NOT CONNECTED		6	NOT CONNECTED
7	NOT CONNECTED		7	NOT CONNECTED
8	NOT CONNECTED		8	NOT CONNECTED
9	NOT CONNECTED		9	NOT CONNECTED

Transmission Setting

There are 6 different speeds that can be used to transmit instruction or information through the RS232/RS485 port on the device, 1200 baud, 2400 baud, 4800 baud, 9600 baud, 19200 baud, and 3840 baud. The default setting from the factory is 9600 baud. Please refer to RS232/RS485 Setting Menu on page 32 for details.

Remote Control Protocol

A computer can be used to control the DVR by sending the packet as follows.

```
=====
Digital video recorder RS 485/232 Control Code Protocol
=====
```

1-1. Sample control code packets

Example 1 : A packet that send "REC" key to Digital Video Recorder (ID=5)

```
0x85      (length)
0x00      (Receiver ID high byte)
0x05      (Receiver ID low byte)
0x4B      (OPcode = key )
0x08      (DATA1 = "Rec" keycode )
0x5D      (checksum)
```

Example 2 : A packet that send "PAUSE" key to Digital Video Recorder (ID=4999)

```
0x85      (length)
0x27      (Receiver ID high byte)
0x07      (Receiver ID low byte)
0x4B      (OPcode = key )
0x0C      (DATA1 = "Pause" keycode )
0x0A      (checksum)
```

Example 3 : A packet that send "PLAY" key to all Digital Video Recorder (broadcast)

```
0x85      (length)
0x7f      (Receiver ID high byte)
0x7f      (Receiver ID low byte)
0x4B      (OPcode = key )
0x0B      (DATA1 = "Play" keycode )
0x59      (checksum)
```

2-1. The format of message packet is as follows:

```

Length Byte (Prefix: 0x86, 0x87, or 0x88 ..... )
Receiver ID high byte
Receiver ID low byte
Opcode Byte
Data Byte1
Data Byte2
Data Byte3
.
.
Checksum Byte
    
```

2-2. Length Byte

This Length Byte is also a prefix. Bit7 must be 1.

EX: 0x87 ==> this packets has 7 bytes length. (not included Length byte itself)

2-3. Receiver ID

1). Individual receiver ID

Decimal	14bit binary value	Hbyte	byte	Receiver ID (Digital Video Recorder)
0	0000000 0000000	00	00	ID = 0
1	0000000 0000001	00	01	ID = 1
2	0000000 0000010	00	02	ID = 2
....				
126	0000000 1111110	00	7e	ID = 126
127	0000000 1111111	00	7f	ID = 127
128	0000001 0000000	01	00	ID = 128
129	0000001 0000001	01	01	ID = 129
255	0000001 1111111	01	7f	ID = 255
256	0000010 0000000	02	00	ID = 256
....				
511	0000011 1111111	03	7f	ID = 511
....				
16382	1111111 1111110	7f	7e	ID = 16382

2). Broadcast ID

Decimal	14bit binary value	Hbyte	Lbyte	Receiver ID (Digital Video Recorder)
16383	1111111 1111111	7f	7f	all Digital Video Recorder connect to RS485

2-4. Opcode Byte & Data bytes

2-4-1. OPcode

Opcode	Data1	Function
0x4B	Keycode	A remote key pressed

2-4-1. A remote key pressed (OPcode=0x4B)

Data1	Key
0x00	key 'CH1'
0x01	key 'CH2'
0x02	key 'CH3'
0x03	key 'CH4'
0x04	key 'MODE'
0x05	key 'ZOOM'
0x06	key 'SEQ'
0x07	key 'MENU'
0x08	key 'REC'
0x09	key 'REV.PLAY'
0x0A	key 'STOP'
0x0B	key 'PLAY'
0x0C	key 'PAUSE'
0x0D	key 'SEARCH'
0x0E	key 'COPY'
0x0F	key 'DISPALY'
0x10	key 'SHUTTLE << x2"
0x11	key 'SHUTTLE << x4"
0x12	key 'SHUTTLE << x6"
0x13	key 'SHUTTLE << x8"
0x14	key 'SHUTTLE << x16"
0x15	key 'SHUTTLE << x32"
0x16	key 'SHUTTLE << x600"
0x17	key 'SHUTTLE >> x2"
0x18	key 'SHUTTLE >> x4"
0x19	key 'SHUTTLE >> x6"
0x1a	key 'SHUTTLE >> x8"
0x1b	key 'SHUTTLE >> x16"
0x1c	key 'SHUTTLE >> x32"
0x1d	key 'SHUTTLE >> x600"
0x1e	key 'JOG<'
0x1f	key 'JOG>'

2-5. Checksum Byte

Checksum is computed as the sum of all previous byte (including the length byte), then mask with 0x7f.

Remote Control

(Optional)

- The remote controller is an accessory to enhance the handy operations of digital video recorder (Figure 1). You can do all the settings and operations by the remote controller. The effective distance is up to 10 meters without any obstacles. The keypad functions are as same as the front panel of the digital video recorder .

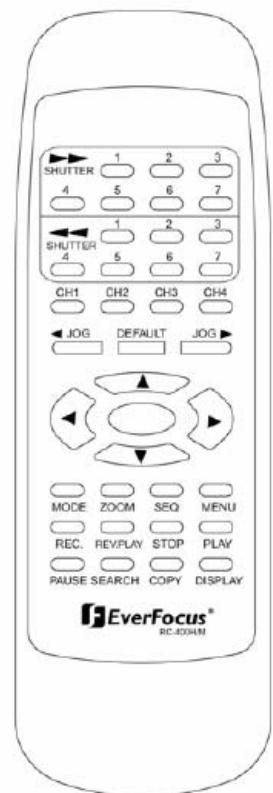

Figure 1

B

Time Lapse Mode Recording Time

When Recording with an 80-GB HDD

(Estimated with typical image-low noise level)

Lower : 15 kB

Low : 19 kB

Basic : 23 kB

Standard : 27 kB

High : 31 kB

Superior : 35 kB

NTSC							
						system storage(GB):	80
Recording Speed (IPS)	PICTURE QUALITY (KB)						
	LOWER	LOW	BASIC	STANDARD	HIGH	SUPERIOR	
	15	19	23	27	31	35	
60	24.7	19.5	16.1	13.7	11.9	10.6	
30	49.4	39	32.2	27.4	23.9	21.2	
20	74.1	58.5	48.3	41.2	35.8	31.7	
15	98.8	78	64.4	54.9	47.8	42.3	
10	148.1	117	96.6	82.3	71.7	63.5	
5	296.3	233.9	193.2	164.6	143.4	127	
1	1481.5	1169.6	966.2	823	716.8	634.9	
0.5	2963	2339.2	1932.4	1646.1	1433.7	1269.8	
0.3	4938.3	3898.6	3220.6	2743.5	2389.5	2116.4	
0.2	7407.4	5848	4830.9	4115.2	3584.2	3174.6	

PAL							
Recording Speed (IPS)	PICTURE QUALITY (KB)						
	LOWER	LOW	BASIC	STANDARD	HIGH	SUPERIOR	
	15	19	23	27	31	35	
50	29.6	23.4	19.3	16.5	14.3	12.7	
25	59.3	46.8	38.6	32.9	28.7	25.4	
10	148.1	117	96.6	82.3	71.7	63.5	
5	296.3	233.9	193.2	164.6	143.4	127	
2	740.7	584.8	483.1	411.5	358.4	317.5	
1	1481.5	1169.6	966.2	823	716.8	634.9	
0.5	2963	2339.2	1932.4	1646.1	1433.7	1269.8	
0.4	3703.7	2924	2415.5	2057.6	1792.1	1587.3	
0.2	7407.4	5848	4830.9	4115.2	3584.2	3174.6	
0.1	14814.8	11695.9	9661.8	8230.5	7168.5	6349.2	

Reference:24H=1 day,168H=1 week, 720H=1 month,8760H=1 year

When Recording with a 160-GB HDD

(Estimated with typical image-low noise level)

Lower : 15 kB
 Low : 19 kB
 Basic : 23 kB
 Standard : 27 kB
 High : 31 kB
 Superior : 35 kB

NTSC						
						system storage(GB): 160
Recording Speed (IPS)	PICTURE QUALITY (KB)					
	LOWER	LOW	BASIC	STANDARD	HIGH	SUPERIOR
	15	19	23	27	31	35
60	49.4	39	32.2	27.4	23.9	21.2
30	98.8	78	64.4	54.9	47.8	42.3
20	148.1	117	96.6	82.3	71.7	63.5
15	197.5	155.9	128.8	109.7	95.6	84.7
10	296.3	233.9	193.2	164.6	143.4	127
5	592.6	467.8	386.5	329.2	286.7	254
1	2963	2339.2	1932.4	1646.1	1433.7	1269.8
0.5	5925.9	4678.4	3864.7	3292.2	2867.4	2539.7
0.3	9876.5	7797.3	6441.2	5487	4779	4232.8
0.2	14814.8	11695.9	9661.8	8230.5	7168.5	6349.2

PAL						
Recording Speed (IPS)	PICTURE QUALITY (KB)					
	LOWER	LOW	BASIC	STANDARD	HIGH	SUPERIOR
	15	19	23	27	31	35
50	59.3	46.8	38.6	32.9	28.7	25.4
25	118.5	93.6	77.3	65.8	57.3	50.8
10	296.3	233.9	193.2	164.6	143.4	127
5	592.6	467.8	386.5	329.2	286.7	254
2	1481.5	1169.6	966.2	823	716.8	634.9
1	2963	2339.2	1932.4	1646.1	1433.7	1269.8
0.5	5925.9	4678.4	3864.7	3292.2	2867.4	2539.7
0.4	7407.4	5848	4830.9	4115.2	3584.2	3174.6
0.2	14814.8	11695.9	9661.8	8230.5	7168.5	6349.2
0.1	29629.6	23391.8	19323.7	16460.9	14336.9	12698.4

Reference:24H=1 day,168H=1 week, 720H=1 month,8760H=1 year

Alarm Board Configuration

Note: Alarm Connectors (DB-15)

The alarm connector, figure 1, is used to provide one sensor alarm input for each camera input. For easy operation, an alarm extension board, figure 2, is provided to connect to the alarm connector.

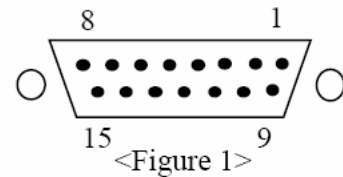

Each alarm input requires two wires, one wire connects to the desired alarm input pin, the second wire connects to the multiplexer ground. The alarm signal assignment is shown at the following table, table 1.

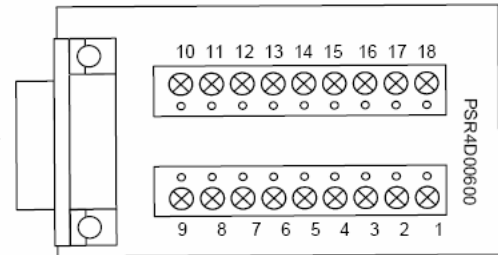

<Table 1>

<Figure 2>

PIN #	NAME	PIN #	NAME
1	GND	10	GPIN2
2	RECIN	11	DISK_FULL
3	ALMRST	12	GPOUT1
4	ALMIN4	13	GPOUT2
5	GND	14	GND
6	ALMIN3	15	ALM_NC
7	ALMIN2	16	ALM_NO
8	ALMIN1	17	ALM_COM
9	GND	18	GND

(a.) Alarm out

There are two ways to do the alarm out connection:

Normally open connection (use pin # 13 and # 14)

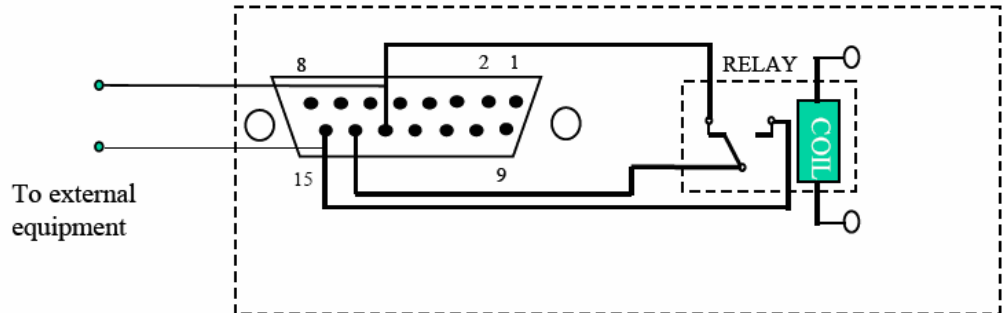

Normally Closed Connection (use pin # 13 and # 12)

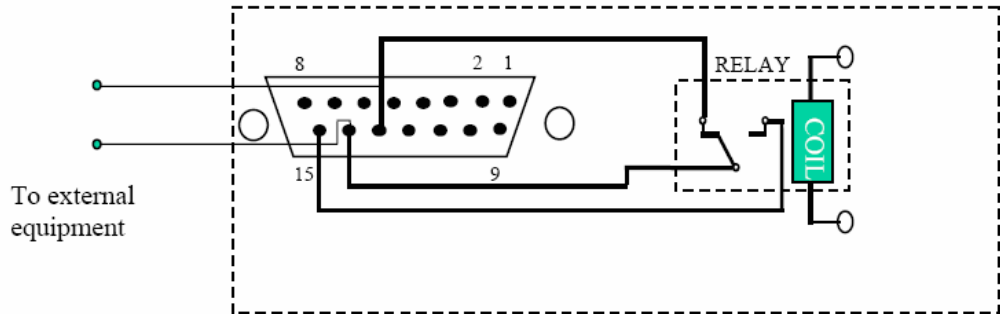

(b) Alarm in and alarm reset

There are 4 alarm sensors in for 4 channels and 1 alarm reset in, all these 5 alarm inputs can be set to Normally Open or Normally Closed by user.

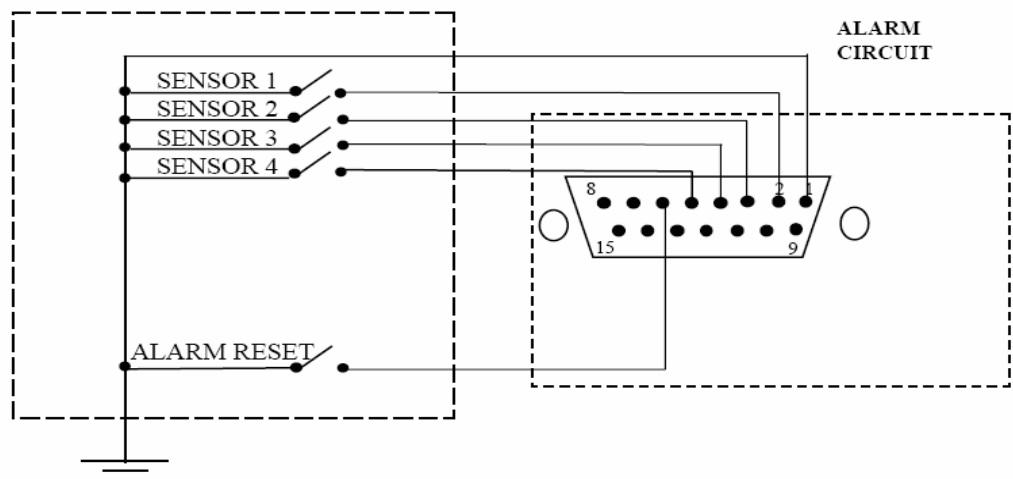

Alarm in

There are four alarm inputs. Please connect the alarm input in the same sequence as the cameras input BNC.

When any alarm signal comes in, the Digital Video Recorder will do the following:

1. Display Alarm Message
2. Turn on the buzzer if the buzzer setting is on.

The **ALARM in** can be selected as normally open input or normally closed input:

Normally Open : If the alarm input is selected as Normally Open input, then the (N.O.) input is opened normally, and shorted to the ground means an alarm happens.

Normally Close : If the alarm input is selected as Normally Close input, then the (N.C.) input is shorted to the ground normally, and opened input means an alarm happens.

Troubleshooting

If you have difficulty operating your system, run through the following checklist to see if you can solve the problem.

❑ The DVR will not go into record mode?

- Make sure the HDD is locked in with the keys. Also check to make sure the hard drives are set to Master. A diagram located on the Hard Drive Label will show you how to set the drive to master.

❑ DVR only records for a few hours?

- If motion recording is not properly set up this problem will arise. The recommended motion set up for maximum video storage (HDD).
 - 1) Press the menu button, and use the **JOG Dial** to traverse through the menu until **Motion Setting Menu** is reached.
 - 2) Under the OP option, select the cameras or channels that you want to record on motion detection and turn them on the **ON** position.
 - 3) Set the desired Alarm Record and Quality to your preference. (**NOTE:** Alarm record is representing the IPS recorded when motion is detected on a camera)
 - 4) From this page you can also press the arrows to pull up and edit the masking grid. Exit out of the Motion menu when you are finished.
 - 5) Next use the **JOG Dial** to traverse until **Normal Record Setting** menu is reached.
 - 6) Set the Normal Speed at a lower recording speed (IPS) anywhere between 0.1-5 IPS; refer to Appendix A & B. (select desired quality)
 - 7) There is also the option to record Pre-Alarm. This will record at the same IPS set for Alarm prior to the Alarm or Motion activity.
 - 8) Lastly, you must make sure the REC light is continually illuminated.

****Explanation:** The DVR will record at a lower IPS when there is no motion, which will conserve HDD space. When motion is detected by a camera, the DVR will record at a higher IPS. This will insure a higher resolution during motion events play back.

❑ **The DVR displays no picture?**

- First question you should ask yourself is the equipment wired properly. Please see your installation manual for help.
- The second question to ask yourself, do all the wires used work properly.
- The next step is to verify the recorder is getting the correct amount of power.

❑ **There is no display coming from one of the channels on the DVR?**

- The first step is to verify is the problem coming from the recorder or the camera.
- Simply take a working camera and plug it into the port that seems to not be working. If you see a picture this means the problem is coming from the camera.

❑ **CF R/W error of I/O Error when trying to archive to a compact flash card?**

- This error is usually a file incompatibility error with the flash card. One most common reason would be if you were using a compact flash card made by Lexar. If you own a lexar Compact flash card please purchase a Sandisk or Kingston compact flash card. Also please make sure the Flash Card is greater than 32 MB.
- If you own a compabile flash card then make sure the flash card is formatted in Fat32 file system. See your Windows Manual on How to format the flash card in Windows.

❑ **I cannot connect to the recorder via the internet?**

1. The first thing to check is does your internet provider block any ports.
2. Are you using the IP address from the Internet Service provider?
3. If you are using a router are the ports in your router opened?
(**NOTE:** Please be sure that ports 80, 1111, 2222, 3333, 4444, 6666 are open.)
4. If you are using Windows XP please update the Java Virtual Machine. This can be done by going to <http://java.sun.com> and downloading the file called JavaVM.

❑ **If you have a Dynamic IP address from your Internet Service Provider.**

- Dynamic IP addresses can cause conflicts when trying to connect to DVR(s) on a high speed internet connection. With new router technology (DDNS), it allows you to overcome this problem. DDNS lets you assign a fixed host and domain name to a dynamic Internet IP address. It is useful when you are hosting your own DVR, website, FTP server, or other server behind the Router. Before using this feature, you need to sign up for DDNS service at www.dyndns.org or

www.tzo.com. (Preferred routers: Linksys BEFSR41 V3 or DLINK DI624 or any router that offers DDNS.

CE Declaration

This equipment has been tested and found to comply with the limits for a **CE Class B** digital device,

The changes or modifications not expressly approved by the party responsible for compliance could void the user's authority to operate the equipment.

In a domestic environment this product may cause radio interference. In which case the user may be required to take adequate measures.

EverFocus Electronics Corp.

Head Office:

12F, No.79 Sec. 1 Shin-Tai Wu Road,
Hsi-Chi, Taipei, Taiwan
TEL : +886-2-26982334
FAX : +886-2-26982380

European Office:

Albert-Einstein-Strasse 1
D-46446 Emmerich, German
TEL : +49-2822-9394-0
FAX : +49-2822-939495

USA Office:

2445 Huntington Drive, San Marino,
CA 91108, U.S.A.
TEL : +1-626-844-8888
FAX : +1-626-844-8838
Toll free : +1-888-383-6287 or
+1-888-EV-FOCUS

Beijing Office:

Room 609, Technology Trade Building,
Shandgi Information Industry Base,
Haidian District, Beijing,China
TEL : +86-10-62971096
FAX : +86-10-62971432

Japan Office:

1809 WBG Marive East 18F,
2-6 Nakase.Mihama-ku.
Chiba city 261-7118, Japan
TEL : +81-43-212-8188
FAX : +81-43-297-0081



Free Manuals Download Website

<http://myh66.com>

<http://usermanuals.us>

<http://www.somanuals.com>

<http://www.4manuals.cc>

<http://www.manual-lib.com>

<http://www.404manual.com>

<http://www.luxmanual.com>

<http://aubethermostatmanual.com>

Golf course search by state

<http://golfingnear.com>

Email search by domain

<http://emailbydomain.com>

Auto manuals search

<http://auto.somanuals.com>

TV manuals search

<http://tv.somanuals.com>