



User Manual



EMV400 DVR

EVERFOCUS ELECTRONICS CORPORATION

EMV400 DVR

Instruction Manual

© 2010 EverFocus Electronics Corp
www.everfocus.com

All rights reserved. No part of the contents of this manual may be reproduced or transmitted in any form or by any means without written permission of the Everfocus Electronics Corporation.

Release Date: Oct. 2010

QuickTime is a registered trademark of the Apple Computer, Inc.

Windows is a registered trademark of the Microsoft Corporation.

Linksys is a registered trademark of the Linksys Corporation.

D-Link is a registered trademark of the D-Link Corporation.

DynDNS is a registered trademark of the DynDNS.org Corporation.

Other product and company names mentioned herein may be the trademarks of their respective owners.

Safety Precautions

- Refer all work related to the installation of this product to qualified service personnel or system installers.
- Do not block the ventilation openings or slots on the cover.
- Do not drop metallic parts through slots. This could permanently damage the appliance. Turn the power off immediately and contact qualified service personnel for service.
- Do not attempt to disassemble the appliance. To prevent electric shock, do not remove screws or covers. There are no user-serviceable parts inside. Contact qualified service personnel for maintenance. Handle the appliance with care. Do not strike or shake, as this may damage the appliance.
- Do not expose the appliance to water or moisture, nor try to operate it in wet areas. Do take immediate action if the appliance becomes wet. Turn the power off and refer servicing to qualified service personnel. Moisture may damage the appliance and also may cause electric shock.
- Do not use strong or abrasive detergents when cleaning the appliance body. Use a dry cloth to clean the appliance when it is dirty. When the dirt is hard to remove, use a mild detergent and wipe gently.
- Do not overload outlets and extension cords as this may result in a risk of fire or electric shock.
- Do not operate the appliance beyond its specified temperature, humidity or power source ratings. Do not use the appliance in an extreme environment where high temperature or high humidity exists. Use the DVR at indoor type temperatures within -20°C ~ 55°C (-4°F ~ 131°F). The input power source for this device is 10V~36VDC.
- **Read Instructions**
All the safety and operating instructions should be read before the unit is operated.
- **Retain Instructions**
The safety and operating instructions should be retained for future reference.
- **Heed Warnings**
All warnings on the unit and in the operating instructions should be adhered to.
- **Follow Instructions**
All operating and use instructions should be followed.
- **Cleaning**
Unplug the unit from the outlet before cleaning. Do not use liquid cleaners, abrasive or aerosol cleaners. Use a damp cloth for cleaning

- **Attachments**
Do not use attachments not recommended by the product manufacturer as they may cause hazards.
- **Water and Moisture**
Do not use this unit near water-for example, near a bath tub, wash bowl, kitchen sink, or laundry tub, in a wet basement, near a swimming pool, in an unprotected outdoor installation, or any area which is classified as a wet location.
- **Servicing**
Do not attempt to service this unit by yourself as opening or removing covers may expose you to dangerous voltage or other hazards. Refer all servicing to qualified service personnel.
- **Power Cord Protection**
Power supply cords should be routed so that they are not likely to be walked on or pinched by items placed upon or against them, playing particular attention to cords and plugs, convenience receptacles, and the point where they exit from the appliance.
- **Object and Liquid Entry**
Never push objects of any kind into this unit through openings as they may touch dangerous voltage points or short-out parts that could result in a fire or electric shock. Never spill liquid of any kind on the unit.



ATTENTION! This is a class A product which may cause radio interference in a domestic environment; in this case, the user may be urged to take adequate measures.



Federal Communication Commission Interference Statement

This equipment has been tested and found to comply with the limits for a Class B digital device, pursuant to Part 15 of the FCC Rules. These limits are designed to provide reasonable protection against harmful interference in a residential installation. This equipment generates, uses and can radiate radio frequency energy and, if not installed and used in accordance with the instructions, may cause harmful interference to radio communications. However, there is no guarantee that interference will not occur in a particular installation. If this equipment does cause harmful interference to radio or television reception, which can be determined by turning the equipment off and on, the user is encouraged to try to correct the interference by one of the following measures :

- Reorient or relocate the receiving antenna.
- Increase the separation between the equipment and receiver.
- Connect the equipment into an outlet on a circuit different from that to which the receiver is connected.
- Consult the dealer or an experienced radio/TV technician for help.

FCC Caution: Any changes or modifications not expressly approved by the party responsible for compliance could void the users' authority to operate this equipment.



WEEE



This Product is RoHS compliant.

The information in this manual was current upon publication. The manufacturer reserves the right to revise and improve his products. Therefore, all specifications are subject to change without prior notice. Manufacturer is not responsible for misprints or typographical errors.
Please read this manual carefully before installing and using this unit. Be sure to keep it handy for later reference.

TABLE OF CONTENTS

1	PRODUCT OVERVIEW	1
1.1	FEATURES	1
1.2	PACKAGE CONTENTS.....	2
1.3	SPECIFICATIONS	3
1.4	FRONT PANEL	5
1.5	REAR PANEL.....	7
1.6	SYSTEM CONNECTION.....	9
1.7	REAR PANEL CONNECTOR.....	10
1.8	INSTALLATION OF EMV400	12
1.9	VIDEO INPUTS/OUTPUTS INSTALLATION.....	17
1.10	AUDIO INSTALLATION.....	17
1.11	ALARM CONTACTS INSTALLATION	17
1.11.1	Alarm Input Contacts	18
1.11.2	Alarm Output Relay.....	18
1.12	USB-MOUSE INSTALLATION.....	18
1.13	NETWORK CONNECTION.....	18
1.13.1	Direct PC Connection through Crossover Network Cable	19
1.13.2	Network Connection through Patch Cable.....	19
1.14	FINAL INSTALL PROCESS	20
2	MOUSE OPERATION.....	21
2.1	GENERAL USB MOUSE OPERATION	21
2.1.1	How to select a channel.....	21
2.1.2	OSD Root Menu.....	21
2.1.3	Field Input Options	22
3	CONFIGURATION.....	23
3.1	CONFIGURATION OF DVR.....	23
3.2	LOGIN.....	23
3.3	ON SCREEN CONFIGURATION MENU	24
3.4	SEARCH	26
3.4.1	Time Search.....	26
3.4.2	G Sensor Search.....	27
3.4.3	GPS Speed Search.....	28
3.4.4	Event Search.....	30
3.5	ARCHIVE (USB)	32
4	DVR CONFIGURATION.....	33
4.1	CONFIGURATION MENU.....	33
4.2	CAMERA SETTING	35
4.2.1	Normal.....	35

4.2.2	<i>Video Adjust</i>	36
4.2.3	<i>Alarm</i>	37
4.3	RECORD SETTING	38
4.3.1	<i>Record</i>	38
4.4	ALARM/GPS	39
4.4.1	<i>Alarm-Alarm Settings</i>	39
4.4.2	<i>Alarm-Event Settings</i>	41
4.4.3	<i>Alarm – Video Loss</i>	50
4.4.4	<i>Alarm-G-Sensor Settings</i>	52
4.4.5	<i>Alarm-GPS Speed</i>	53
4.4.6	<i>Alarm-GPS Event Action</i>	54
4.4.7	<i>Alarm-GPS Fencing</i>	55
4.5	DATE/TIME SETTING	56
4.5.1	<i>Date/Time Settings</i>	56
4.5.2	<i>Daylight Saving</i>	57
4.6	DISPLAY	58
4.6.1	<i>Title</i>	58
4.6.2	<i>Monitor On Screen Display</i>	58
4.6.3	<i>Layout</i>	60
4.6.4	<i>Sequence</i>	61
4.7	NETWORK SETTING	62
4.7.1	<i>LAN Settings</i>	62
4.7.2	<i>Wireless Settings</i>	65
4.7.3	<i>Mobile Connection Settings</i>	66
4.7.4	<i>Email Settings</i>	67
4.7.5	<i>DDNS Settings</i>	68
4.7.6	<i>Alarm Server Settings</i>	70
4.8	SYSTEM	71
4.8.1	<i>User</i>	71
4.8.2	<i>I/O Control</i>	74
4.8.3	<i>DISK Info</i>	77
4.8.4	<i>LOG</i>	78
4.8.5	<i>SETTINGS</i>	80
4.8.6	<i>SERVICE</i>	81
4.9	INFORMATION	82
5	NETWORKING OVERVIEW	83
5.1	INTRODUCTION TO TCP/IP	83
5.2	SUBNET MASKS	83
5.3	GATEWAY ADDRESS	83
5.4	VIRTUAL PORTS	84
5.5	PRE-INSTALLATION	84
5.6	WHAT IS YOUR NETWORK SETUP?	85
5.7	SIMPLE ONE TO ONE CONNECTION	86
5.8	DIRECT HIGH SPEED MODEM CONNECTION	91
5.9	ROUTER OR LAN CONNECTION	93
6	REMOTE OPERATION FROM BROWSER	96
6.1	CONNECTING TO EMV400	96

6.2	BROWSER SECURITY SETTING	97
6.2.1	<i>Installing ActiveX controls</i>	97
6.2.2	<i>Enabling ActiveX Controls</i>	100
6.3	REMOTE LIVE VIEW	103
6.4	REMOTE PLAYBACK	105
7	EVERFOCUS DDNS SETUP	106
8	LINKSYS & D-LINK PORT FORWARDING	108
8.1	TYPICAL LINKSYS PORT FORWARDING	108
8.2	TYPICAL D-LINK PORT FORWARDING	110
9	TROUBLESHOOTING	113
	APPENDIX A: TIMING OF ALARM MODES.....	115
	APPENDIX B: EXPRESS SETUP RECORDING VALUE SELECTION RULES	118
	APPENDIX C: REMOTE CONTROL.....	120

1 PRODUCT OVERVIEW

Full featured video surveillance on the move: the EverFocus EMV400 digital video recorder, with H.264 compression technology for enhanced recording capacity and improved network image transmission speed with high image quality, delivers real-time video and audio recording on all 4 channels (120FPS @ 2CIF/ 60fps @ D1 resolution, frame rate and resolution independently configurable for each camera). The DVR provides multiple interfaces including 3 USB ports, RS-485, RS-232, GPS port, wired and WiFi Ethernet, IR remote control, 6 alarm inputs and 2 alarm outputs. Video outputs are provided at both front and rear panels for ease of installation and maintenance, plus the new easy to read graphical user interface is specially designed for use with portable small-screen monitors. The power supply in the EMV400 provides surge protection, voltage regulation, and programmable delay power on/off for the DVR and the system cameras. Added to this, comprehensive features including hot swap hard drive, embedded 3-axis g-sensor, GPS receiver interface, 802.11b/g WiFi, individual camera power outputs, remote control capability and shock/vibration resistant locking Molex connectors make this DVR the best choice for your 1~4 channel portable and mobile recording applications.

1.1 FEATURES

- 4Channels of video and audio recording
- 1-DIN car audio size
- Recording Rate : 60fps @ D1 resolution / 120fps @ 2CIF or CIF resolution (with global settings; record rate, resolution and quality can be set independently per-camera up to the maximum of 240 CIF-equivalent FPS)
- H.264 compression format for efficient disk and network utilization
- Front and rear panel video outputs for easy connection and configuration
- Special Graphical User Interface design for use with mobile small-sized monitors
- Molex connectors for shock & vibration resistance; interface cables to BNC, RCA and power jacks supplied
- Alarm Inputs & Outputs : 6 & 2 (alarm outputs are form "C")
- Embedded 3-axis g-sensor function with separate programmable alarm levels for X/Y and Z axis
- Supports single 2.5" SATA hard disk standard (up to 1TB)
- Supports multiple interfaces: 3xUSB , RS-485, RS-232, GPS port, wired Ethernet, IR Remote Control
- Optional wireless 802.11 b/g with diversity antennas
- Provides camera power for 4 cameras; interface cables to power jacks supplied
- Optional External EDGE/GPRS/CDMA/WI-FI Modules for cellular/specialized wireless Transmission
- GPS function tracks speed and geographic limits (optional external GPS receiver)
- Power Supply : 10V~36VDC with Surge Protection, Voltage Regulator, programmable Delay on/off

- Temperature : -20°C ~ 55°C (Operating), -20°C ~ 85°C (Non-Operating)

1.2 PACKAGE CONTENTS

- Digital Video Recorder x1
- HDD Tray x 1
- HDD Fixing Bracket x 1 set
- Screws x 1 pack
- Antenna x 1 set
- IR Remote Control x 1
- Battery x 2
- Camera Power cable x 3
- Video & Audio cable x 3
- Alarm cable x 1
- Alarm Output cable x 1
- RS232/RS485 cable x 1
- GPS cable x 1
- DVR power cord x 1

1.3 SPECIFICATIONS

EMV400 - 4CH Mobile DVR

Video Format	NTSC/PAL (auto detected by system)
Operating System	Embedded Linux with special small monitor friendly GUI
Video Input	4 channels (vibration resistant locking Molex connectors – Interface cables to BNC-F supplied: two groups of 2 cameras each)
Video Output	Main monitor: 1 composite BNC rear panel / 1 front panel RCA output
Video Compression	H.264
Recording Resolutions	NTSC: 720x480/720x240/360x240 PAL: 720x576/720x288/360x288
Audio Inputs	4 line in (vibration resistant locking Molex connectors - Interface cables to RCA-F supplied: two groups of 2 cameras each)
Audio Outputs	1 front panel RCA line out
Alarm Inputs	6 alarm inputs (vibration resistant locking Molex connectors - Interface cables supplied)
Alarm Outputs	2 alarm outputs (form "C"; contacts rated at 30V AC/DC @ 1 amp – interface cables supplied)
Storage	2.5" HDD x 1(up to 1TB)
Recording Rate	NTSC: D1 60FPS, 2CIF 120f FPS, CIF 240 FPS PAL: D1 50 FPS, 2CIF 100 FPS, CIF 200 FPS Per camera resolutions and record rates can be set individually per camera through the OSD menus up to the maximum record capacity of 240 NTSC (200 PAL) CIF equivalent FPS
Recording Mode	Continuous recording, event recording, continuous + event recording (Rate and resolution in each mode set independently per camera)
Record Quality	Adjustable in five levels per camera per Record Mode
Pre Alarm Recording	Optional; 5 second interval
Playback Rate	NTSC: D1 60 FPS, 2CIF 120 FPS, CIF 240 FPS PAL: D1 50 FPS, 2CIF 100 FPS, CIF 200 FPS
Playback Search	Time/date, event search
Video Loss Detection	Yes
Event Alarm	Fan failure, hard disk temperature, hard disk failure, hard disk full, hard disk removed, power loss (after power is restored), network loss, GPS loss, GPS speed, GPS fencing, G sensor limits

Email alert	Multiple email notifications in response to alarms and events. (Requires real time network connectivity though cellular or WiFi service).
G Sensor	Embedded 3-axis G Sensor; data recorded; alarm if separate user limits for X/Y or Z axis exceeded
GPS Function	Optional External GPS Sensor for speed and geographic limit alarms (rectangular or circular fencing)
Configuration Method	On screen menu with 'portable monitor friendly' graphical user interface
Control/Setup	IR remote control, USB mouse, network I/F
Real time clock	Can be synchronized to GPS/NTP time source; flexible DST settings
Watchdog Function	Reboots DVR automatically if required
Networking	RJ45 socket, 10/100Mbps; 802.11b/g WiFi with diversity antennas TCP-IP/DHCP/PPPoE/DDNS/SNMP/SSL/POP3/HTTP/NTP
System Warnings	System fail LED : HDD full, HDD/Sys Temp, Fan fail, HDD fail LED : HDD power off, HDD failure
File Export	USB 2.0 interface
Interfaces	RS-232 x 2, RS-485, USB x 3, GPS port
Power Source	13.8VDC nominal; 10V~36VDC range (Built in surge protection, voltage regulation, programmable Delay On/Off relative to ignition or other switched voltage) Total current 5.5 amps @ 12VDC with 4ch x 450mA cameras
Camera Power Outputs	900mA for camera 1~2 and 900mA for camera 3~4. Vibration resistant locking Molex connectors – interface cable provided to coaxial power plugs: 2 X groups of 2 cameras.
Dimensions	DVR alone : 178 x 50 x 199mm / 7"x 2"x 7.8"(1-DIN size) DVR in mount with antennas 272 x 145 x 224mm / 10.7"x 5.7"x 8.8"
Weight	DVR without mount 1.7kg / 3.75lbs. DVR with mount 2.15kg / 4.74lbs
Operating Temp.	Working Temperature: -20°C~55°C; -4F~131°F Storage Temperature: -20°C~85°C; -4F~185°F

1.4 FRONT PANEL

Your primary interaction with your new DVR will be through the Front Panel buttons and their corresponding buttons on the included IR Remote Control. Take a moment to learn where the keys are as the remainder of the manual will refer to them often.

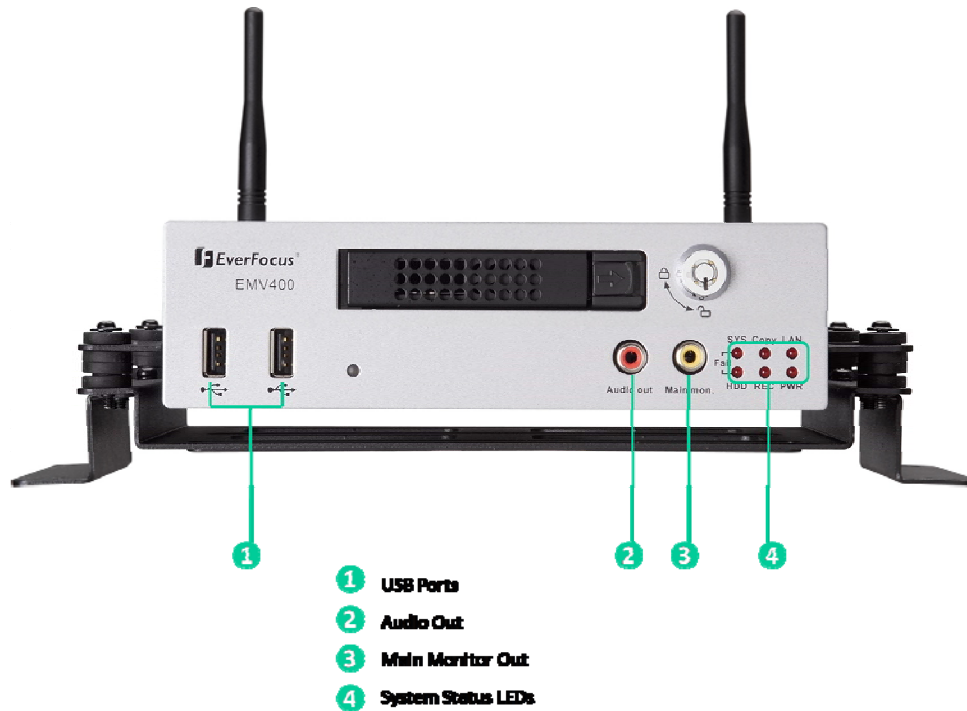

Figure 1-1 Front Panel

- 1) **USB 2.0:** For connecting USB-Flash-Drive to copy/archive video or for firmware upgrades.
- 2) **Audio Out:** Connect to the line level input of an audio amplifier (same output as the audio out at rear panel, no conflict between these 2 outputs, they both can be connected simultaneously).
- 3) **Main Monitor Out:** Main monitor for live and playback display and on-screen display. (same output as the main monitor out at rear panel, no conflict between these 2 outputs, they both can be connected simultaneously).
- 4) **System Status LEDs:** Indicators system status.
System fail LED: HDD full, HDD/System Temperature, Fan fail
HDD fail LED: HDD power off, HDD failure
Copy: This LED ON indicates system is archiving data.

LAN: This LED ON indicates **Network** active. Network LED turns on depending on the network type (LAN, Wireless or Mobile) set in Network setting.

Record: This LED ON indicates **Record** active.

Power: This LED ON indicates **Power** on.

1.5 REAR PANEL

During initial setup you will be connecting your DVR to multiple input and output devices. This is done through the rear panel.

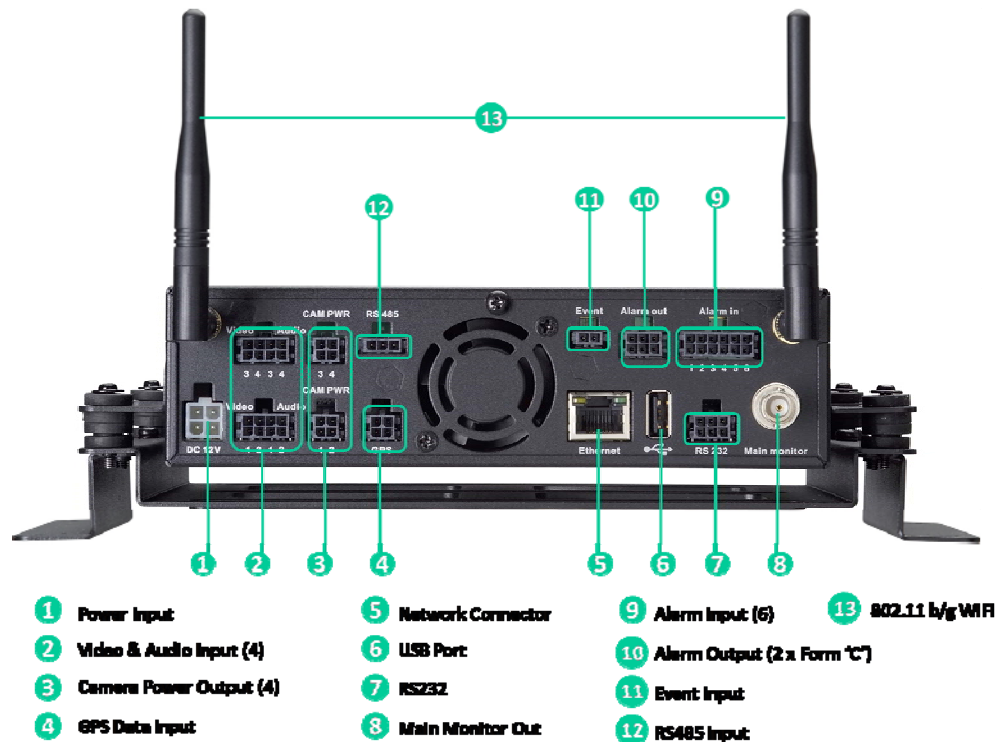

Figure 1-2 Rear Panel

- ① **Power Input/Ignition Control In/Switched power out:** 4 pins are reserved for power input; connect to 10V~36VDC power source. 1 pin is for ignition control; connect to the other vehicle devices to avoid excess power consumption at ignition. 1 pin is reserved for switched power out. The power source used for this additional power output is 600 mA x 12VDC.
- ② **Video & Audio Inputs (4):** Connect camera's video output or other composite video source to the video input connection. Connect line level output of an audio preamplifier to the audio input connection corresponding to the appropriate camera.
- ③ **Camera Power Outputs (4):** EMV400 can provide power source to the cameras, connect camera power to this output by using the camera power cable. The power source used is 450mA x 12VDC.

- ④ **GPS Data Input:** Connect this connector to GPS receiver via GPS cable.
- ⑤ **Network Connector:** RJ-45 network connection 10/100Mbps Ethernet. There are two LEDs on the LAN jack; Green LED means network is connected, amber LED flickers when data is being exchanged.
- ⑥ **USB port:** USB port recommended for connecting the USB mouse.
- ⑦ **RS232 socket:** Connect this connector to RS232/RS485 compatible device.
- ⑧ **Main Monitor Out:** Main monitor for live and playback display and on-screen display. (same output as the main monitor out at front panel, no conflict between these 2 outputs, they both can be connected simultaneously)
- ⑨ **Alarm Input:** Connect up to 4 alarm inputs, selectable between N.O./N.C. contacts.
- ⑩ **Alarm Output:** N.C or N.O type alarm out (form "C").
- ⑪ **Event Input:** Reserved port.
- ⑫ **RS485 Input:** For remote control via RS-485 keyboards and telemetry control for attached PTZ devices.
- ⑬ **802.11 b / g WiFi:** Connection of the antenna.

1.6 SYSTEM CONNECTION

Please refer to the following diagrams for the system connections.

Note: Monitor and Camera must be purchased separately.

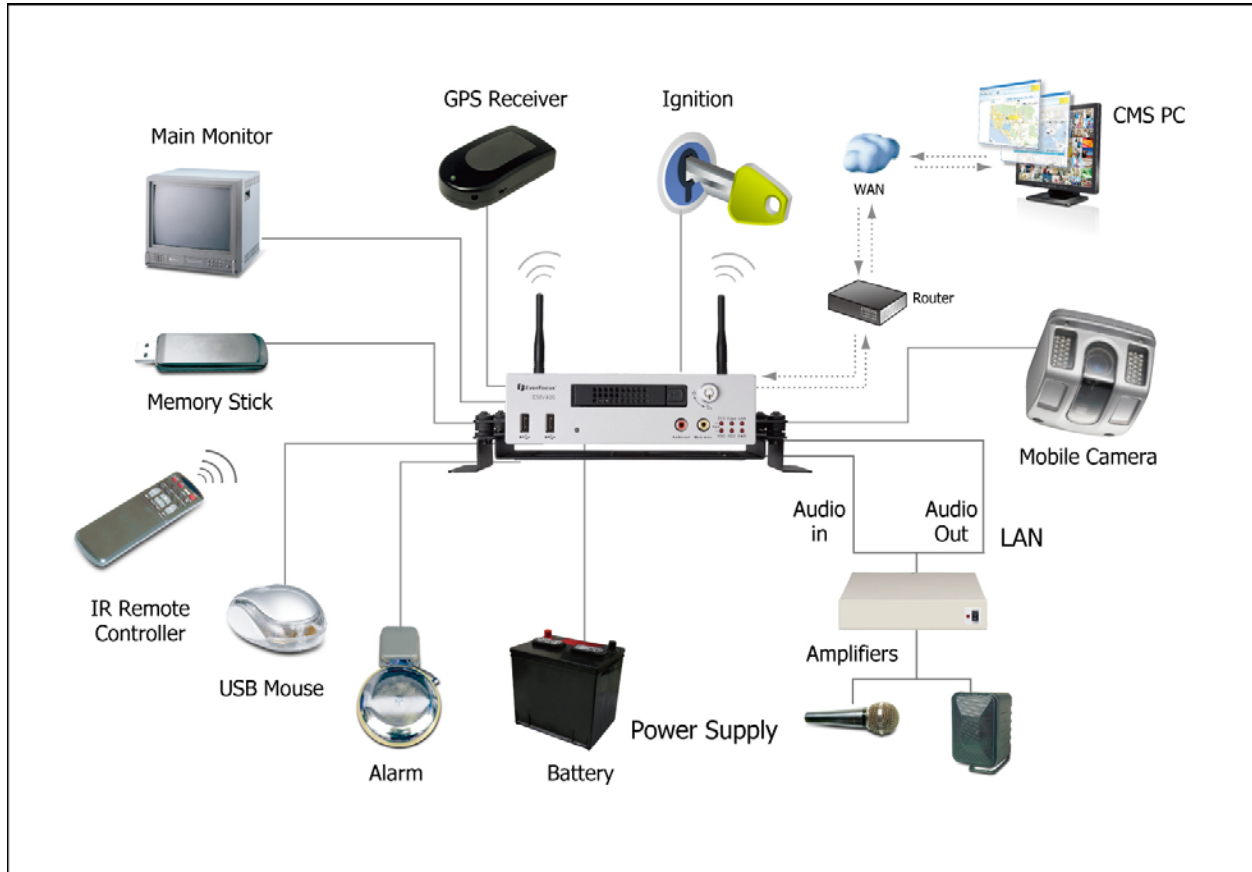

1.7 REAR PANEL CONNECTOR

RS232/RS485

[]		
485+	485-	GND

POWER

[]	
IGN	[]
GND	12V

ALARM IN

[]					
ALARM IN1	ALARM IN2	ALARM IN3	ALARM IN4	ALARM IN5	ALARM IN6
GND	GND	GND	GND	GND	GND

ALARM OUT

[]		
NO1	COM1	NC1
NO2	COM2	NC2

VIDEO/AUDIO IN1

[]			
VIDEO IN1	VIDEO IN2	VIDEO IN3	VIDEO IN4
GND	GND	GND	GND

VIDEO/AUDIO IN2

[]			
VIDEO IN1	VIDEO IN2	VIDEO IN3	VIDEO IN4
GND	GND	GND	GND

CAM POWER1

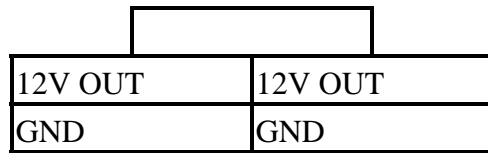

CAM POWER2

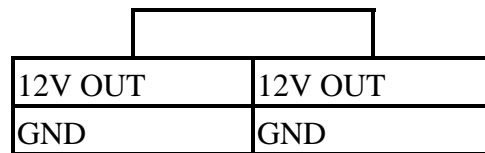

GPS

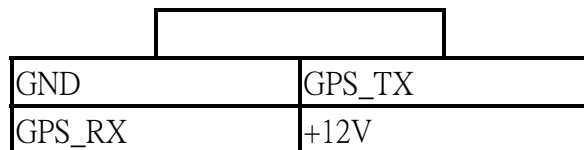

1.8 INSTALLATION OF EMV400

- The DVR can be mounted horizontally (suspend or support mounted).

Support

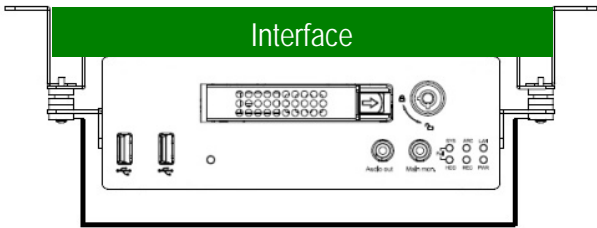
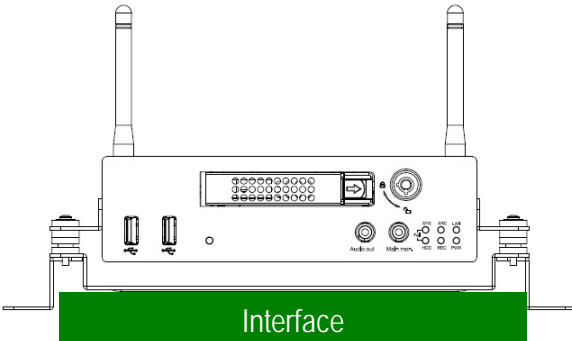

Suspend

- Show all the possible ways to mount the DVR. Use the two Z-brackets supplied to mount it in any ways shown.

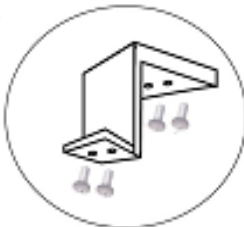
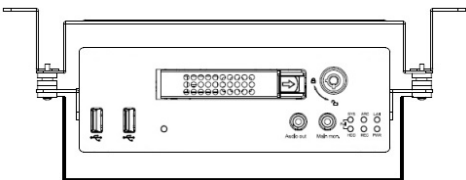
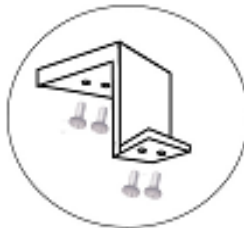
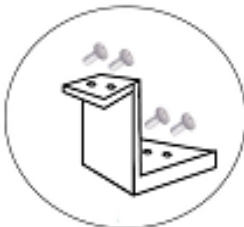
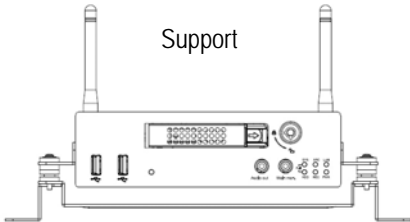
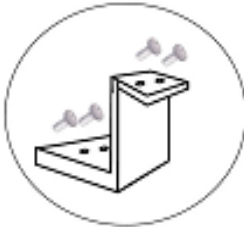

Suspend

Quick Installation Guide

□ Unpack Everything

Make sure you have everything you need before you begin the installation.

□ Equipment Required

The following tools may help you to complete the installation:

- Drill
- Screwdrivers
- Wire cutters

□ Choosing the Location

Choose a location for installation that:

- Provides convenient access for installing or removing the hard drive
- Allows air to flow around the fan vents. Inadequate or improper air flow can impede proper operation of the unit

Avoid any location for installation:

- That is subject to high vibration
- That is subject to high sunlight levels
- That is subject to drenched of the rain
- Where passengers can interfere with unit
- Next to a heater duct

The following table lists the recommended location options.

Location	Convenient operation	Easy to install	Low vibration	Good air flow
Bottom of glove box- horizontal mount	Yes	Yes	Yes	Yes
Bottom of passenger seat next to the driver	NO	Yes	Yes	Yes
Underneath bulkhead-horizontal mount	Yes	Yes	NO	Yes
Front of bulkhead-horizontal mount	Yes	Yes	Yes	Yes
Beside driver seat-horizontal mount	Yes	Yes	Yes	Yes

Caution: Do not install the DVR on the floor or on the transmission access hatch. These locations have the highest levels of vibration and may be subject to water damage.

- Possible Installation Locations Inside the Automobile Vehicle: Truck

Glove box (inside or underneath)

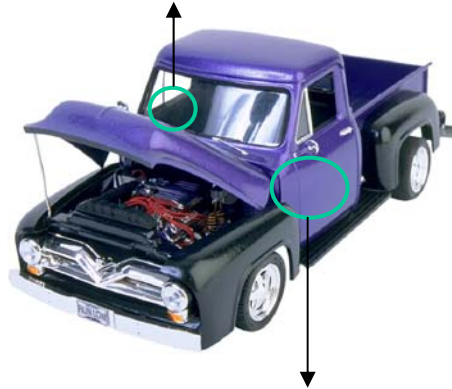

Drive seat (between seat and wall) or Passenger seat (underneath)
(Users are suggested to use "support" for mounting option)

- Show the wiring on the wiring harness that connects to the electrical system.

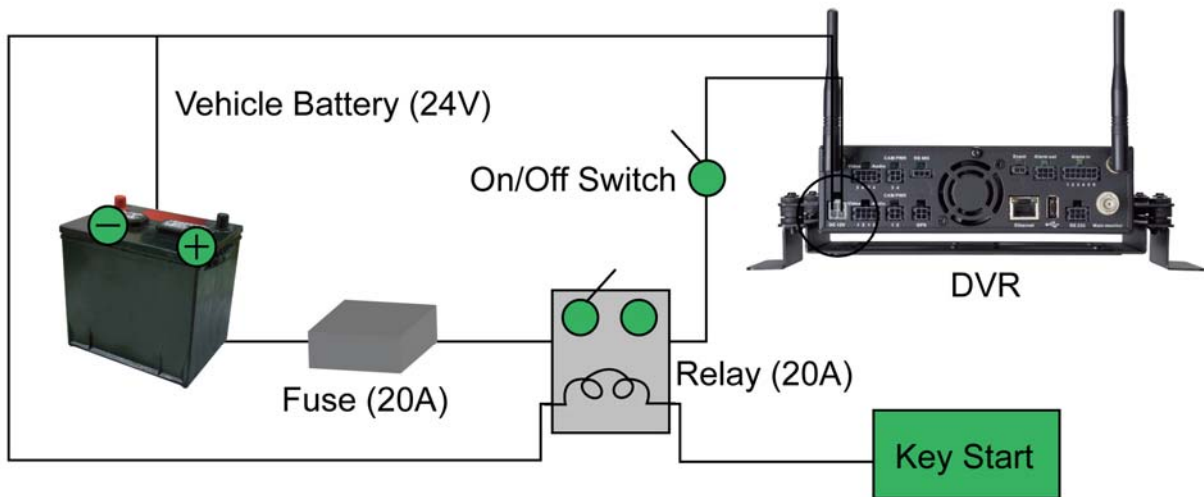

□ Possible Installation Locations Inside the Automobile Vehicle

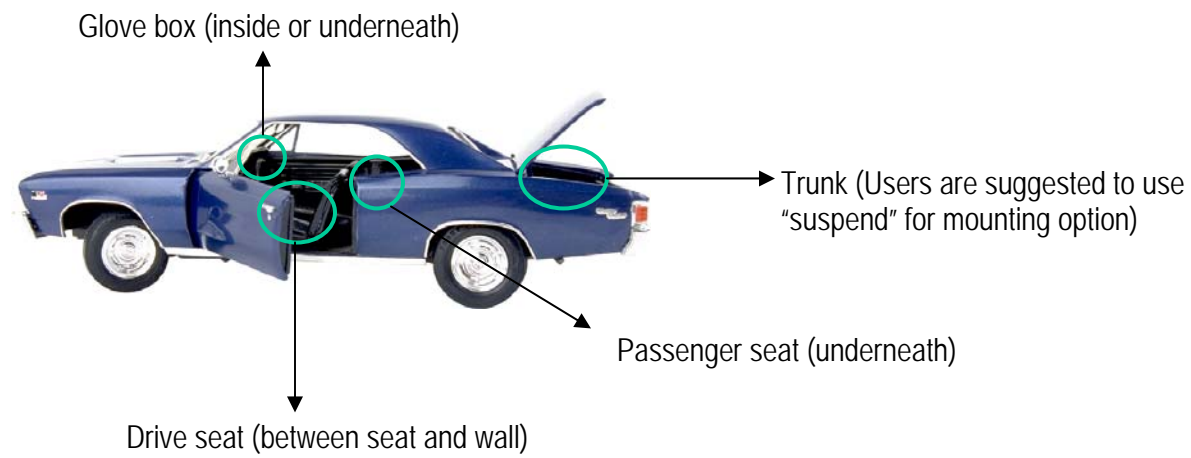

□ Show the wiring on the wiring harness that connects to the electrical system.

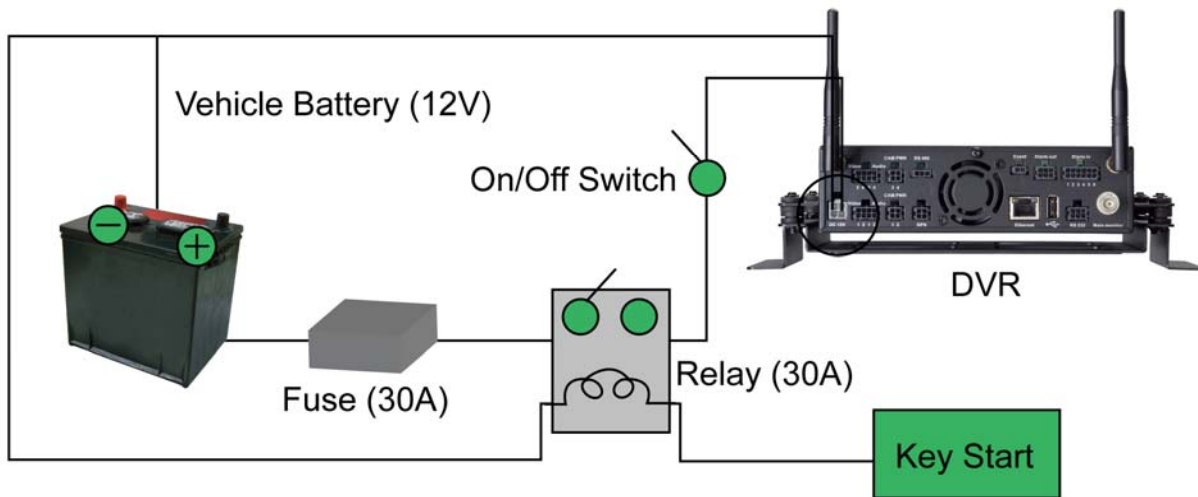

□ **Installing the Camera(s) and Monitor**

The DVR is typically connected to one camera installed inside the car. Other camera(s) can also be installed in different locations (for example, use the waterproof camera to the outside of vehicle). For installation procedure, please refer to the guide that came with the camera(s) you purchased. The Monitor power supply connects from the Automotive adapter (cigarette plug) Monitor and cameras must be purchased separately.



□ **Connect the Camera(s)** Connect the power connector from the camera(s) harness into the CAMERA POWER OUT jack on the back panel of the DVR.

Connect the primary camera(s) video connector to the CAMERA INPUT and the audio connector to the AUDIO INPUT in the back panel.

Adjust the camera(s). After the camera is installed, connect a monitor directly to the camera and observe the image.

Make any adjustment if necessary.

1.9 VIDEO INPUTS/OUTPUTS INSTALLATION

Cameras and CCTV monitors must use copper center conductor/copper braid 75 Ohm video cable (e.g. RG-59, RG-6, RG-11) with BNC connectors.

To avoid impedance mismatch and undesired loss/reflections, 50 Ohm coax cable (e.g. RG-58), or 75 ohm foil shield antenna cable and other types of coaxial cable are not compatible.

All connected video sources must provide a 1 Vpp NTSC or PAL standard video signal.

When converting other transmission types (twisted pair, fiber optics, radio) for the video inputs, be sure to verify accurate receiver calibration and signal levels.

ATTENTION: In order for the system to auto-detect the appropriate video format (NTSC or PAL), make sure that there is a video signal on video input 1 upon power-up.

1.10 AUDIO INSTALLATION

This DVR provides 4 line level audio inputs and 1 line level audio output.

ATTENTION: The direct connection of a non-amplified microphone is not supported (a microphone amplifier is required). The audio output requires an amplifier to drive a speaker or headphones.

The installation must be connected with audio coax cable and RCA plugs.

AUDIO RECORDING FUNCTIONALITY:

Audio recording is activated / deactivated in the Camera Menu for Camera #1~4 respectively. Please check and always comply with local laws and regulations when using audio recording.

The audio channel is always recorded together with video and is independent of the image recording rate. Though the audio record control is done in the Camera #1~4 screen, there is no specific camera allocation.

1.11 ALARM CONTACTS INSTALLATION

The alarm inputs can be used to start recording or for recording rate adjustment. In addition, alarm reactions such as camera display on the monitor, buzzer, e-mail and network alarm are available. The alarm output relay can be switched if required. Alarm input response actions can be controlled according to a flexible schedule.

1.11.1 Alarm Input Contacts

This DVR provides one alarm input per camera. All inputs are programmable N.O. (Normal Open) or N.C. (Normal Closed) Inputs have to be switched by dry contacts.

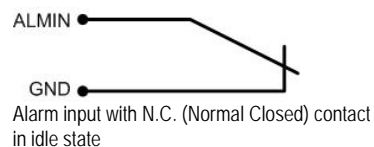
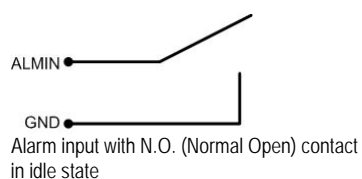

All settings are programmed in the ALARM menu (Section 0).

1.11.2 Alarm Output Relay

The relay output provides either Normally Open or Normally Closed dry contacts.

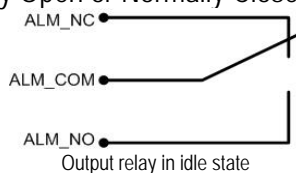

1.12 USB-Mouse installation

Connect the USB mouse to one of the 2 USB ports. (This can be done while DVR is powered on) The rear USB V1.0 port is recommended to reserve the higher speed front USB V2.0 port for video copy/export.

NOTE: Recommended mouse types are Logitech® and Microsoft® wired USB wheel-mouse. Wireless USB mouse is not supported.

1.13 NETWORK CONNECTION

This section only describes physical connection to an Ethernet network. This step must be completed before the DVR can connect to the network. There are two basic types of connection:

1.13.1 Direct PC Connection through Crossover Network Cable

The point-to-point connection of DVR and PC requires a crossover (crossed) network cable. This type of connection is ONLY used for direct connection to a single PC. Make sure that the PC is equipped with a 10/100 Mbps compatible network connection.

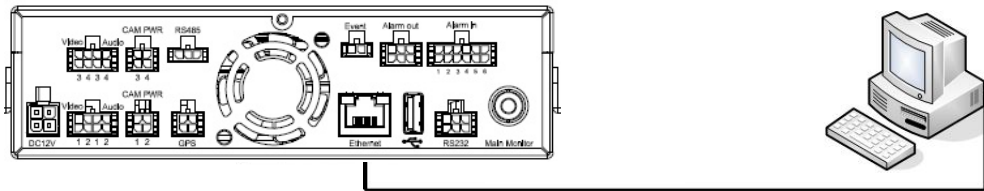
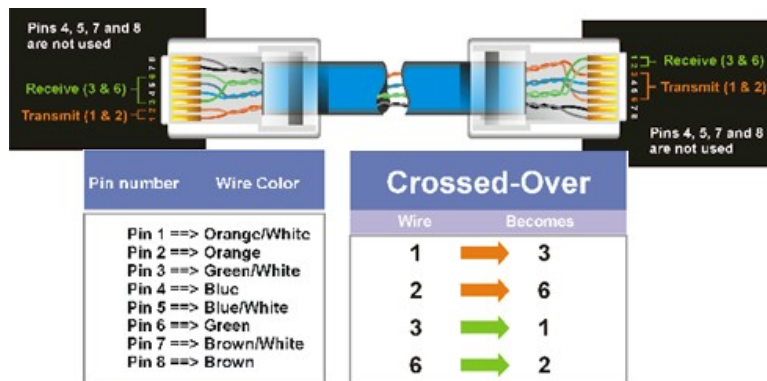

Figure 1-3 Direct PC Connection



Pinout of crossover-cable

1.13.2 Network Connection through Patch Cable

The connection to an existing network requires a normal patch cable (straight-through). The illustration shows the connection to a network switch or router.

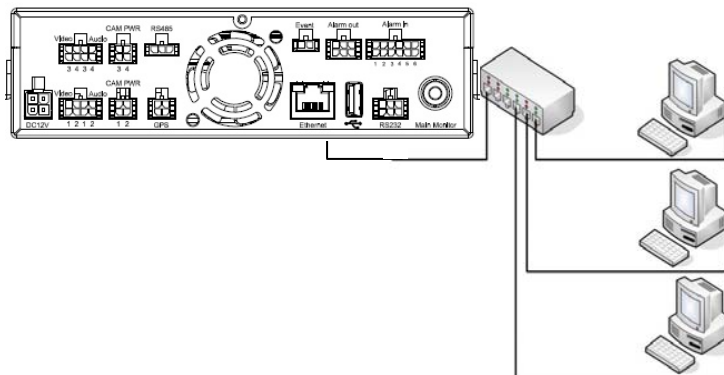
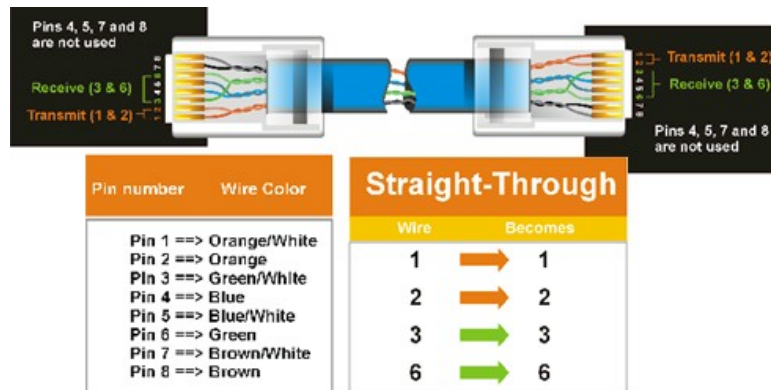

Figure 1-4 Network Connection through Patch Cable



Pinout of straight patch cable

1.14 FINAL INSTALL PROCESS

Once you have completed the basic wiring connections, you are ready to turn on the DVR. Simply plug in the power source. The POWER LED will light up if power is normal. Once the system has finished loading, you can begin to set up the menu options for the DVR.

Note: When the DVR is placed in an environment where the temperature is under -10° , the DVR will **NOT** turn on immediately. The heater will heat up the DVR until the temperature reaches -5° . The DVR will only turn on when the temperature is above -5° .

2 MOUSE OPERATION

EMV400 mobile DVRs support 2 sources to control the DVR. It can be controlled with a mouse and the handheld IR remote control. (For IR remote control, please refer to Appendix C Remote Control)

This chapter will cover the basic operation using the mouse.

2.1 GENERAL USB MOUSE OPERATION

2.1.1 How to select a channel

1. In a view consisting of more than one channel, users can select a channel by clicking once on the desired channel screen. The selected screen will be highlighted by a white frame.
2. Double clicking on a channel screen will display full screen for this channel.

2.1.2 OSD Root Menu

1. Right-click the mouse to obtain the DVR Root menu (see Figure 2-1 OSD Root Menu).

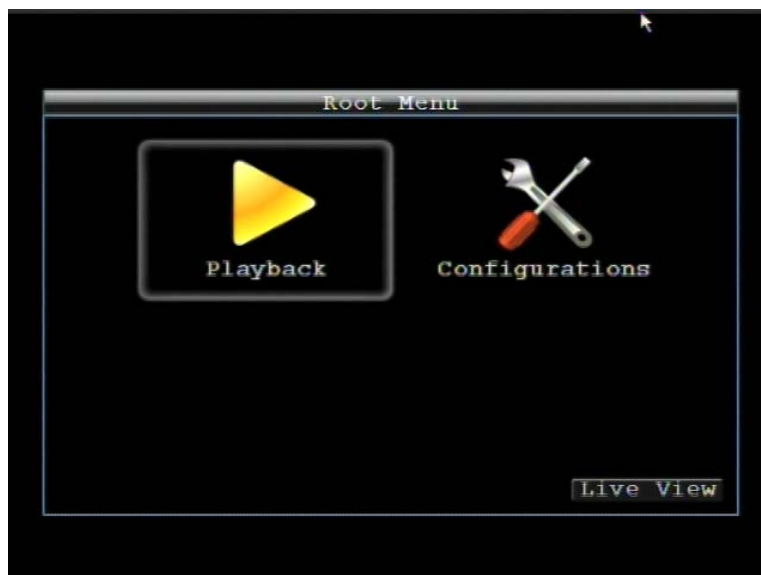

Figure 2-1 OSD Root Menu

2. Click on any icon to perform that action. These actions are covered in detail in Chapter 3.
3. Click the **Live View** button to go to live view.

2.1.3 Field Input Options

The following are examples of different types of fields available in the Configuration menu.



Textbox: Click on the box and an on-screen keyboard will appear*. (see note about the on-screen keyboard below)



Dropdown box: Click on the down arrow to see all selections, then directly click on an option to select it.



Check box: Click on the box to enable it (checked) or disable it (unchecked).

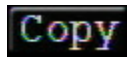

Button: Click the button to execute the function.





*** Note about on-screen keyboard:**

Click on a button to input that character.

The buttons on the right and bottom have the following functions:



Figure 2-2 On-Screen Keyboard

Space	Enter a space
Caps	Switch to capital letters
 / Del	Delete the letter
	Confirm the selection
	Move to right
	Move to left

3 CONFIGURATION

This chapter provides information for configuring EMV400.

3.1 CONFIGURATION OF DVR

EMV400 can be configured through On Screen Display Playback and Configuration

Connect to the "Main Mon" output with a monitor and use the mouse or the remote control to configure menu settings.

3.2 LOGIN

In order to access EMV400 options, users may be asked to log in for authority identification. To log in, follow these steps.

1. Right click on the screen to display the Main Menu
2. The following screen pops up:



Figure 3-1 Login page

3. Select the user name from the drop-down list and input the password. The defaults are:

User name: admin (lower case)

Password: 11111111

To input password: click the password field to bring up the on-screen keyboard (see Figure 3-2 On-screen Keyboard). Click on each button to input the desired characters for the password. When finished, click "↵" on the on-screen keyboard to confirm the password.

+ Click on the "Login" button to log in to the system.



Figure 3-2 On-screen Keyboard

3.3 On Screen Configuration Menu

1. To bring up the Main Menu, right-click with the USB mouse to bring up the root menu.

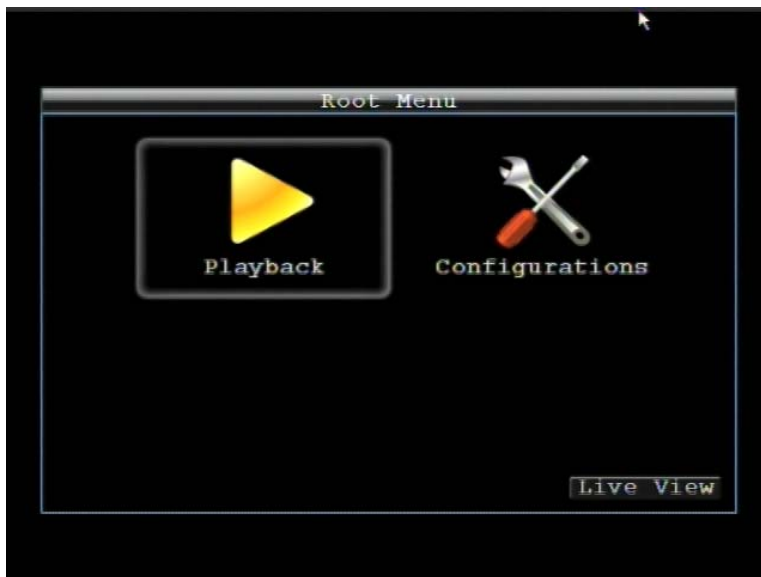











Figure 3-3 On-screen Configuration

2. Left-click on the "Playback" icon  to enter the Playback Menu. A Playback Bar appear as shown below:



Playback Bar	Name	Description
	Layout	TheEMV400 DVR has several display modes available. Click on the desired layout choice
	Display mode	Press to show camera information, press again to show network, HDD, GPS information. Press again to hide all information.
	Audio	Press to cycle through Audio 1, 2,3,4 or no audio
	Fast Rewind	Press to start fast reverse playback
	Play	Press to playback **
	Fast Forward	Press to start fast forward playback
	Search	Press to search by Time, Event, G Sensor or GPS. Please see "3.4 Search" for more details about search function.
	Archive	Press to save a video clip to USB. Please see "3.5 Archive" for more details about archive function.
	Exit	Exit from playback bar

** During playback, DVR will stop recording. When an event occurred while playback, event log will be saved but won't display alarm status.

3.4 SEARCH

Right-click to bring up the Root menu, select Playback and click  to enter Search Menu.

3.4.1 Time Search



Figure 3-4 Search Menu – Time Search

Play From: Select the time to begin the search by choosing the Date and Time.

Click on the **“Play”** button to start the search. The DVR will automatically begin to play the video selected. The DVR will play the nearest time if there is no data at the selected time.

In search playback mode, pressing the **“Stop”** button will return to the search menu.

Record Time (Start): Displays the starting time of record data in the disk.

Record Time (End): Displays the end time of record data in the disk.

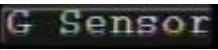
Click  button to enter G Sensor search menu.

Click  button to enter GPS search menu.

Click  button to enter Event search menu.

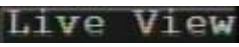
Click  button to go to live view.

3.4.2 G Sensor Search

Click **G Sensor** button to start G Sensor search.



Figure 3-5 Search Menu – G-Sensor Search

From: Select starting date and time

To: Select ending date and time.

Select search format from **Less Than**, **More Than**, **Inside Range** and **Outside Range**.

Value: Set the G-sensor value to be searched. If search format is a range, then set the values for both ends of range.

Click **Search** button to start search action.

Click **GPS** button to enter GPS search menu.

Click **Event** button to enter Event search menu.

Click **Time** button to enter Time search menu.

Click **Live View** button to go to live view.

3.4.3 GPS Speed Search

Click **GPS** button to enter GPS search menu.



Figure 3-6 Search Menu – GPS Search

From: Select starting date and time

To: Select ending date and time.

Display Unit: If the speed is being recorded from the GPS receiver, the desired speed display units must be selected. Select GPS speed unit from KPH and MPH. Selecting MPH converts the GPS signal to display speed in miles per hour.

Select search format from **Less Than, More Than, Inside Range and Outside Range**.

Speed Limit: Set the GPS speed limit to be searched. If search format is a range, then set the values for both ends of range.

Click **Search** button to start search action.

Click **GPS Bordering** button to enter GPS bordering search menu.



Figure 3-7 Search Menu – GPS Bordering Search

From: Select starting date and time

To: Select ending date and time.

GPS Border Type: Set GPS border type, select either circle or rectangle.

Search Mode: Select if searching Inside or Outside the border.

Center Lat.: Set the latitude if border type is circle.

Center Lon.: Set the longitude if border type is circle.

Radius: If GPS border type is circle, this option defines radius. Select radius unit from Km and Mi.

Upper Left Lat.: Set Upper Left Latitude if border type is rectangle.

Upper Left Lon.: Set Upper Left Longitude if border type is rectangle.

Lower Right Lat.: Set Lower Right Latitude if border type is rectangle.

Lower Right Long.: Set Lower Right Longitude if border type is rectangle.

Click **Search** button to start searching.

Click **Back** button to return to the previous level of menu.

Click **GPS** button to enter GPS search menu.

Click **Event** button to enter Event search menu.

Click **Time** button to enter Time search menu.

Click **Live View** button to go to live view.

3.4.4 Event Search

Click **Event** button to enter Event search menu.

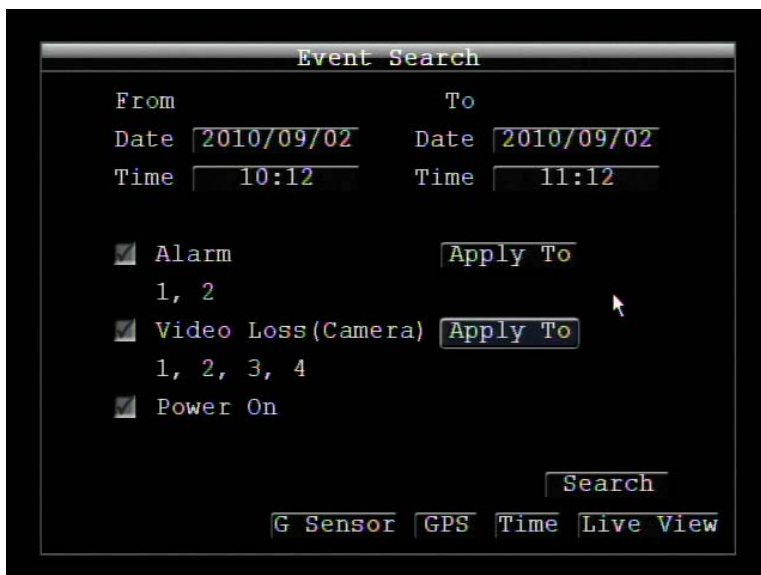

Figure 3-8 Search Menu – Event Search

From: Select starting date and time

To: Select ending date and time.

Select which event type(s) to search for. Choose from Alarm, Video Loss or Power On.

Click on the **Apply To** button to select which cameras to include in the search.

Click on the **Search** button to start searching. The search results will be shown as a list of events.

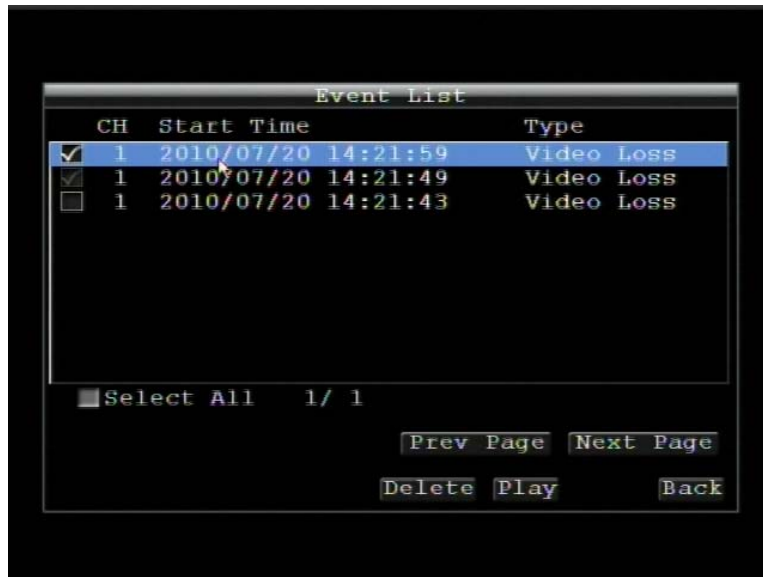

Figure 3-9 Search Menu – Event List

Prev Page: Go to previous page

Next Page: Go to next page

Play: Playback selected item

Delete: Delete selected item

Click **Back** button to return to the previous level of menu.

Click **G Sensor** button to enter G Sensor search menu.

Click **GPS** button to enter GPS search menu.

Click **Time** button to enter Time search menu.

Click **Live View** button to return to live view.

3.5 ARCHIVE (USB)

Right-click to bring up the Root menu, select Playback and click  to enter **Archive Menu**.

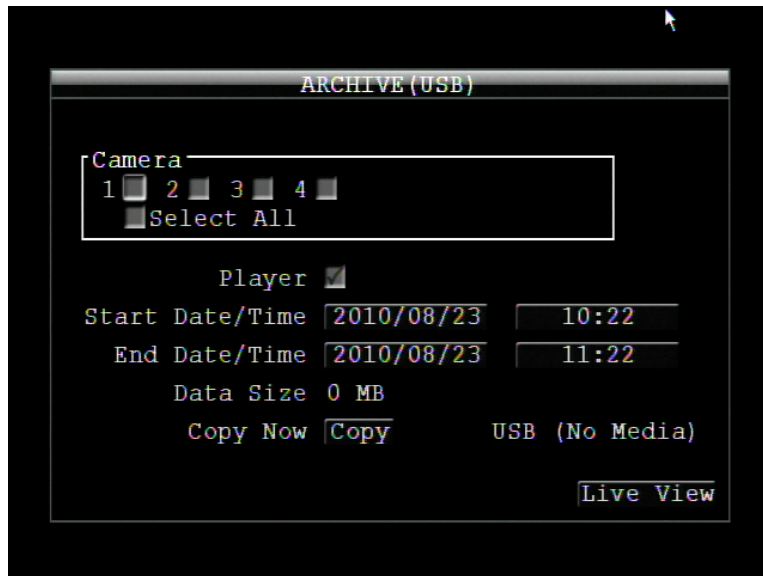

Figure 3-10 Archive Menu

Camera: Select which cameras will be archived. Choose “**Select All**” to select all the cameras.

Player: Check the box to include the ePlayer program as part of the copy (recommended).

Start Date/Time: Select the starting date/time to be archived.

End Date/Time: Select the ending date/time to be archived.

Data Size: Shows the estimated total size for the time period.

Copy Now: Press “**Copy**” button to start archiving data to USB.

Click **Live View** button to return to live view.

4 DVR CONFIGURATION

This chapter will walk you through the DVR Menu Settings step by step and show you how to set the DVR for your specific application.

4.1 Configuration Menu

1. To bring up the Main Menu, right-click with the USB mouse to bring up the root menu.

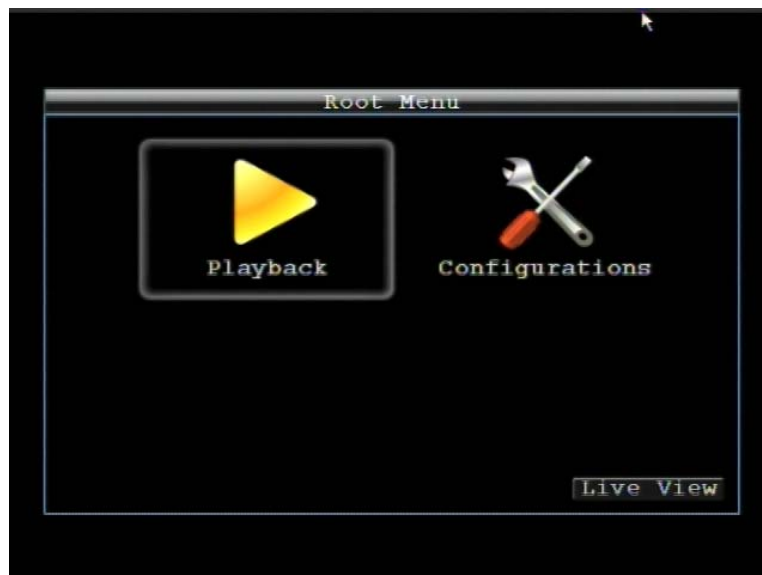

Figure 4-1 Root Menu

2. Left-click on the "Configuration" icon  to enter the Configuration Menu. Log in if necessary (see Section 3.2 LOGIN above).



Figure 4-2 Configuration Menu

4.2 CAMERA SETTING

Figure 4-3 is a screenshot of the **CAMERA SETTING MENU**. This menu is used to configure individual camera settings.

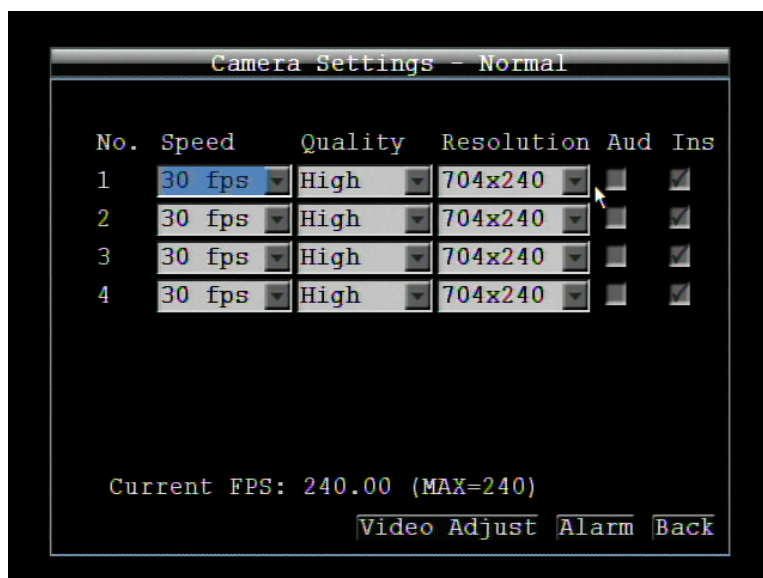

Figure 4-3 Camera Settings-Normal

4.2.1 Normal

No.: Camera number.

Speed: Frame rate in frames (images) per second (FPS) for continuous recording. The speed is limited by the maximum total recording capacity of the DVR as allocated across all the installed cameras, with an upper limit of 30 FPS (NTSC – 25 PAL) per individual camera (real time recording). The DVR is capable of recording 480 CIF (352x240) sized frames per second (NTSC; 400 PAL); each 704x240 image (2 CIF) per second requires allocation of two of those CIF frames from the overall capacity of 480 CIF frames, and each 704x480 image (D1 or 4 CIF) per second requires allocation of four of the CIF frames from the overall capacity. Thus the DVR can record a combination of CIF, 2 CIF and 4 CIF images, with different combinations of image size/resolution and different FPS rates on different cameras, so long as the total CIF equivalents allocated is not greater than 480 CIF per second. Choices for possible record speeds are 30, 15, 10, 7.5, 5, 1 and 0 FPS.

Quality: Select an image quality for recording. There are five different qualities available: Superior, High, Standard, Basic and Low. A higher image quality uses more HDD space.

Resolution: Select recording resolution based on video format.

NTSC: 704x480 / 704x240 / 352x240

PAL: 704x576 / 704x288 / 352x288

Aud: Check this box to enable audio recording on the DVR.

Ins: Check the box to enable the current camera. To take full advantage of the DVR's recording abilities, any unused cameras should have this option set to "disabled".

Click **Video Adjust** button to enter Video Adjust menu.

Click **Alarm** button to enter Alarm menu.

Click **Back** button to return to the previous level of menu.

4.2.2 Video Adjust

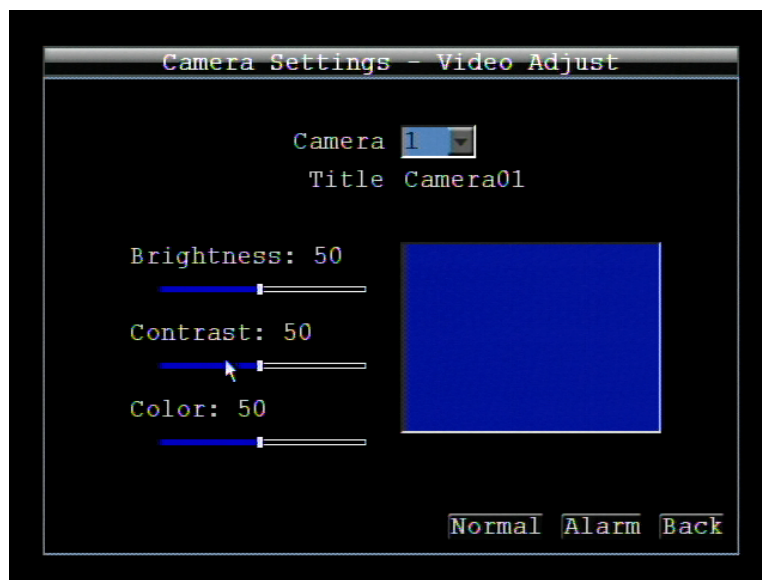

Figure 4-5 Camera Settings-Video Loss

Camera: Select the camera you wish to adjust. "Title" will change to the name of the selected camera.

Brightness: Adjusts how bright/dark the picture appears. If details appear to be lost in the shadows or darker regions, try increasing the Brightness. If the image appears too saturated or if the colors appear overwhelmed by glare, try decreasing the Brightness.

Contrast: Adjusts the total amount of light output from the display. If details are lost or lines appear distorted, try decreasing the contrast.

Color: Adjusts the amount of color information in the picture.

Click **Normal** to enter Camera-Normal setting menu.

Click **Alarm** button to enter Alarm menu.

Click **Back** button to return to the previous level of menu.

4.2.3 Alarm

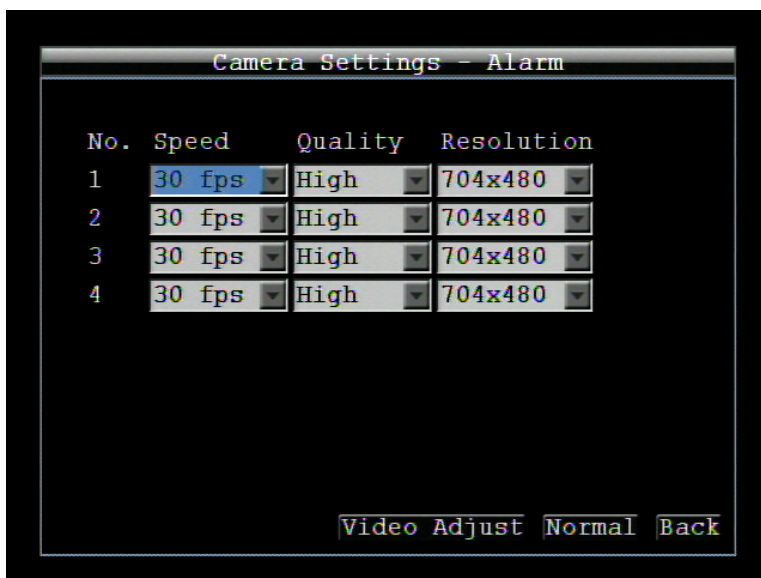

Figure 4-6 Camera Settings-Alarm

Speed:

Maximum desired frame rate in frames per second (FPS) for event recording; if more than one camera requires simultaneous event recording, the total for all cameras cannot exceed the maximum available FPS for the DVR at the corresponding resolution setting, and *the available FPS may be divided across the cameras responding to an event*. In the example above, with 225 CIF FPS allocated and 255 CIF FPS remaining, it would be possible to increase the FPS rate on the two 4 CIF cameras from 10 FPS to 15 FPS and also increase the *resolution and rate* of the five 2 CIF cameras to 4 CIF and 15 FPS, with 15 CIF equivalent FPS still available to be assigned to one or more of the nine CIF resolution cameras. If not all event conditions occur simultaneously, greater resolution and/or FPS increases are possible for individual cameras, as long as the net total of 480 CIF equivalents is not exceeded.

Quality: Select an image quality for recording. There are five different qualities available: Superior, High, Standard, Basic and Low. A higher image quality uses more HDD space.

Resolution: Select recording resolution based on video format.

NTSC: 704x480 / 704x240 / 352x240

PAL: 704x576 / 704x288 / 352x288

Click **Video Adjust** button to enter Video Adjust menu.

Click **Normal** to enter Camera-Normal setting menu.

Click **Back** button to return to the previous level of menu.

4.3 RECORD SETTING

Figure 4- is a screenshot of the **RECORD SETTING MENU**. This menu is used to configure basic recording settings.

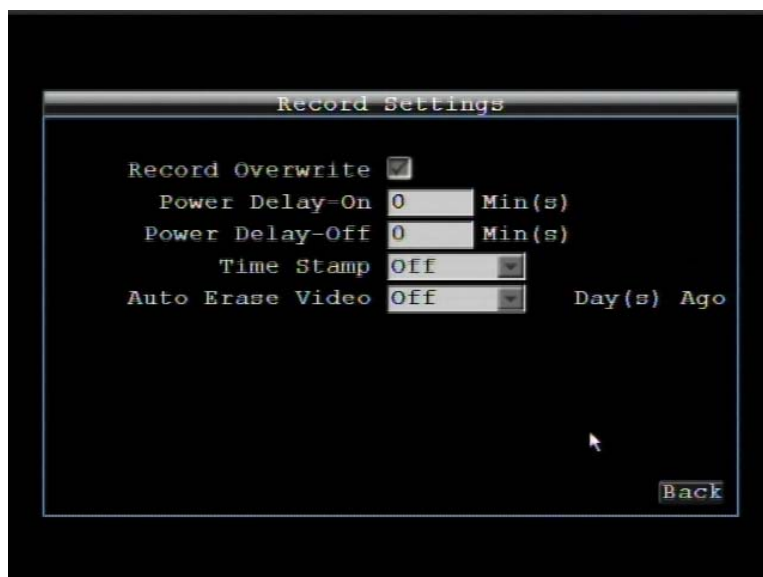

Figure 4-7 Record Settings

4.3.1 Record

Record Overwrite: Check the box and the disk will begin overwriting when full. NOTE: Unless this box is checked, THE DVR MUST STOP RECORDING WHEN THE DISK IS FULL. **The use of record overwrite is strongly recommended.** If you do not use this feature, please be sure to make specific arrangements to monitor/be notified when the disk is full.

Power Delay-On: Set the delay time to supply power to the DVR in order to avoid excess consumption at ignition.

Power Delay-Off: Set the delay time to power off the DVR after ignition off. It can extend the recording time after ignition off.

Time Stamp: Select if the time and date will display while recording. Choose the location for the time display from Top, Bottom or Off.

Auto Erase Video: The hard drive will automatically erase video after it has been on the hard drive for the selected number of days. To use the maximum hard drive space, choose "OFF". (See Record Overwrite and notes above.) This feature is useful if local rules and regulations require recorded video to be discarded after a specific number of days, or to limit the retention of older recorded video to clear space in anticipation of event recording.

Click **Back** button to return to the previous level of menu.

4.4 ALARM/GPS

Figure 4- is a screenshot of the **ALARM/GPS SETTING MENU**. This menu will guide you through alarm and GPS setup.

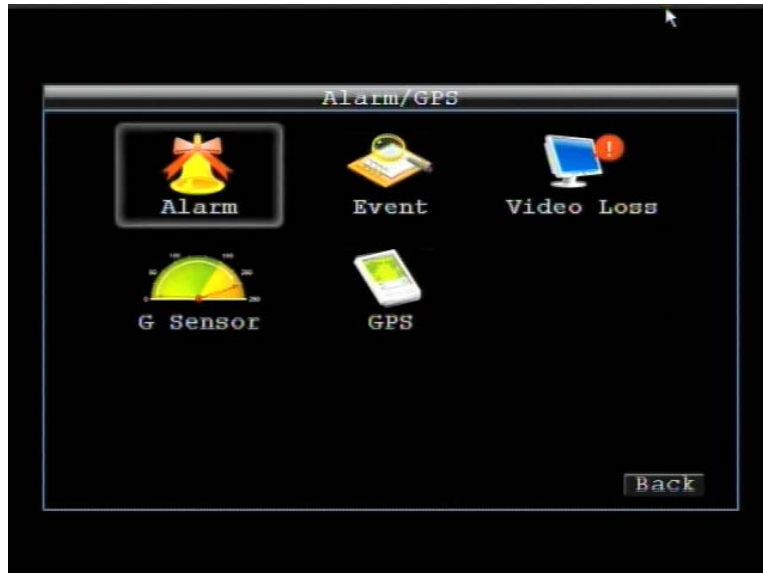

Figure 4-8 Alarm/GPS - Alarm

4.4.1 Alarm-Alarm Settings

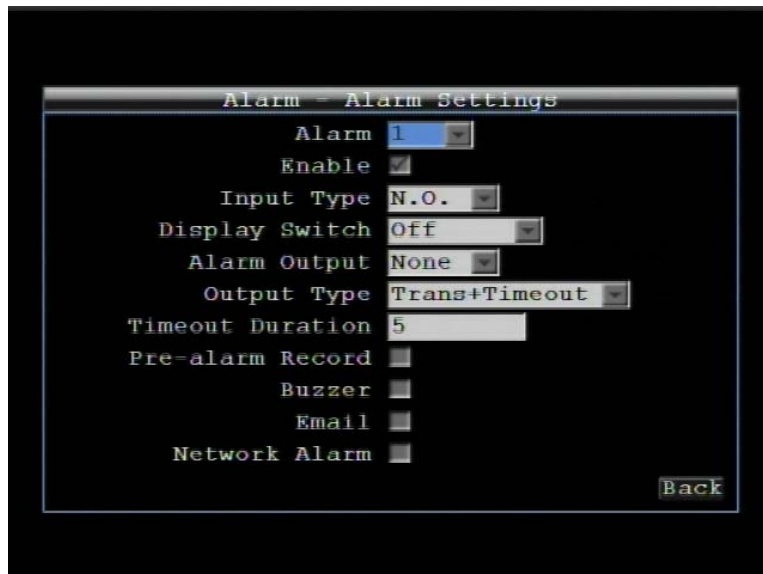

Figure 4-9 Alarm - Alarm Settings

Alarm: Select the alarm input trigger connection number from 1 to 4.

Enable: Check box to enable response to that alarm trigger.

Input Type: This field is to change the type of alarm trigger.

N.O.: Normal Open contact.

N.C.: Normal Closed contact.

Display Switch: Select which channel to be displayed when alarm is triggered. Available options are CH1~4, Quad 1, Quad 2 and Quad 3.

Alarm Output: This will transmit a signal through the alarm output. It can be set to either "NONE" (not active), "1" or "2" (selects alarm relay to be active).

Output Type: Output action when alarm is triggered.

Timeout: Alarm output lasts for the set time duration.

Permanent: Alarm will remain active until the user presses the "Enter" key or resets the alarm remotely.

Transparent: Alarm output remains as long as the alarm input is active.

Trans+Timeout: Alarm output continues until event ends, then continues for the set time duration.

Timeout Duration: Time duration selectable from 1 to 150 seconds.

Pre-alarm Record: Check box to start copying recorded video to the hard disk from 5 seconds before the alarm event. (Pre-alarm recording rate will follow the "Normal" frame rate setting)

Buzzer: Check this box to enable the buzzer when an alarm occurs.

Email: Check box to enable email notification when an alarm occurs. Email operation requires that valid email settings have been entered in the Network Setting/Email setup screen. (See Section 4.7.4 Email for more information.)

Network Alarm: Check this box to send out a network alarm to a client PC when motion occurs. (This feature requires PowerCon software on the client PC and proper settings for the Alarm Server in the Network Setup menu; see Section 4.7.6 Alarm Server for more information.)

Click  button to return to the previous level of menu.

4.4.2 Alarm-Event Settings

This section covers notifications due to internal system event warnings.



Figure 4-10 Alarm – Event Settings

Event: Select from the following event types.

Fan Failure: Fan is not working.

HD Temperature: Hard drive is over the safety warning temperature.

HD Failure: If DVR fails to detect the HDD on start up, the system will create an HD failure event.

HD Full: If the DVR is not set to Overwrite in the Record Menu, an event will be created when the HDD is filled.

HD Off: If HDDs are switched off or are removed, the DVR will create an HD OFF event.

Power Loss: If power is disconnected, an alarm event will be triggered when power is restored.

Network Loss: If connection to the local network is lost, DVR will create a Network Loss event.

NOTE: This function only checks the physical connection (link) to the network. Any network behavior that blocks data connectivity (blocked ports, IP addressing errors, etc.) is not detected by this function.

GPS Loss: If the GPS signal is lost, the DVR will create a GPS Loss event.

Click **Back** button to return to the previous level of menu.

Fan Failure:

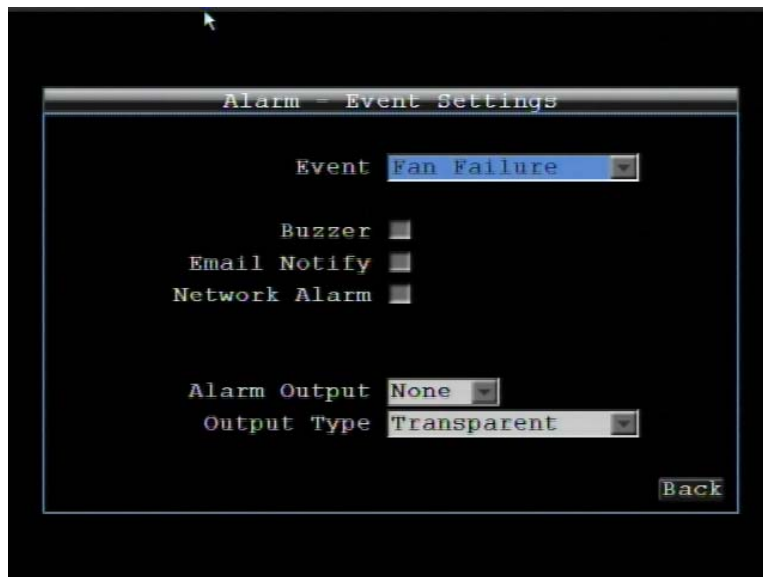

Figure 4-11 Alarm - Event - Fan Failure

Buzzer: Check box to enable buzzer when fan is not working.

Email Notify: Check box to enable email notification when fan is not working. Email operation requires that valid email settings have been entered in the Network Setting/Email setup screen.

Network Alarm: Check box to send out a network alarm to client PC. (requires PowerCon software and setting up Alarm Server in Network Setup menu)

Alarm Output: This will transmit a signal through the alarm output. It can be set to either "NONE" (not active), "1"(active) or "2" (active).

Output Type: Output action will be **Transparent** and cannot be changed (alarm output remains as long as the alarm condition is active).

Click **Back** button to return to the previous level of menu.

HD Temperature:

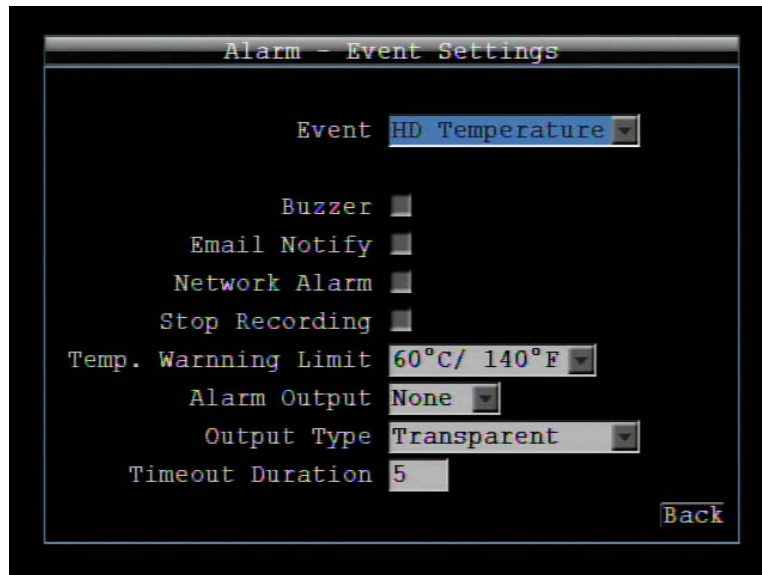

Figure 4-12 Alarm – Event - HD Temperature

Buzzer: Check box to enable buzzer when hard drive's temperature is over the "Temp. Warning Limit".

Email Notify: Check box to enable email notification when HDD temperature is over the "Temp. Warning Limit". Email operation requires that valid email settings have been entered in the Network Setting/Email setup screen.

Network Alarm: Check box to send out a network alarm to client PC. (requires PowerCon software and setting up Alarm Server in Network Setup menu)

Stop Recording: Check box to stop recording when HD's temperature is over the "Temp. Warning Limit".

Temp. Warning Limit: Sets the trigger temperature for HD Temperature event actions. Choose between 55°C /131°F or 85°C /185°F.

Alarm Output: This will transmit a signal through the alarm output. It can be set to either "NONE" (not active) "1" (active) or, "2" (active).

Output Type: Output action will be **Transparent** and cannot be changed (alarm output remains as long as the alarm condition is active).

Timeout Duration: Time duration selectable from 1 to 150 seconds.

Click **Back** button to return to the previous level of menu.

HD Failure:

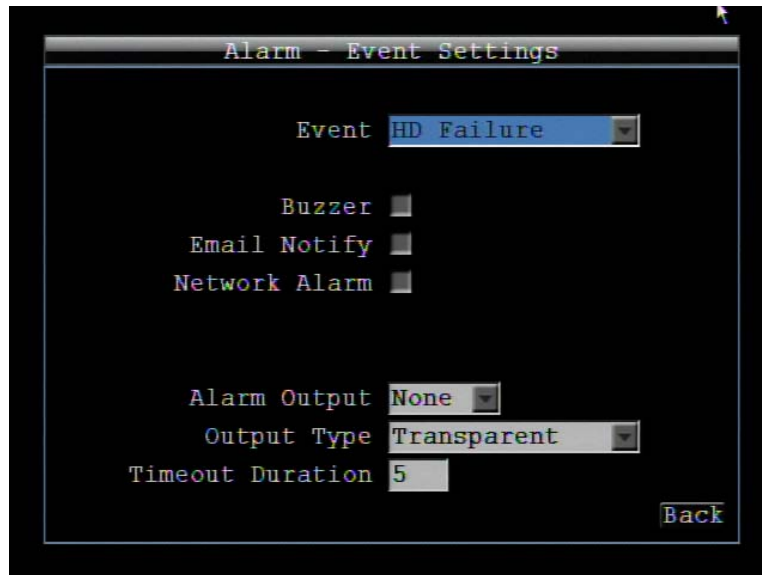

Figure 4-13 Alarm – Event - HD Failure

Buzzer: Check box to enable the buzzer if no hard drive is detected on system startup.

Email Notify: Check box to enable email notification function when HD fails. Email operation requires that valid email settings have been entered in the Network Setting/Email setup screen.

Network Alarm: Check box to send out a network alarm to client PC. (requires PowerCon software and setting up Alarm Server in Network Setup menu).

Alarm Output: This will transmit a signal through the alarm output. It can be set to either "NONE" (not active), "1" (active) or "2" (active).

Output Type: Output action will be **Transparent** and cannot be changed (alarm output remains as long as the alarm condition is active).

Timeout Duration: Time duration selectable from 1 to 150 seconds.

Click **Back** button to return to the previous level of menu.

HD Full:

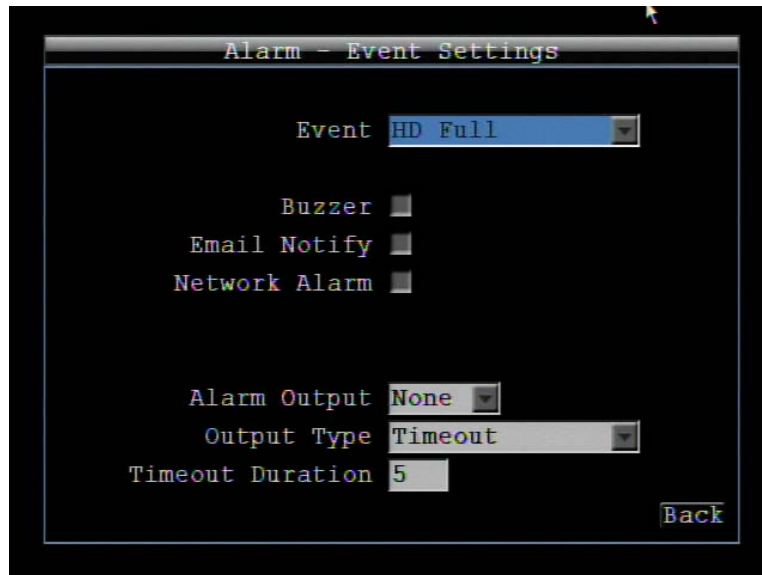

Figure 4-14 Alarm - Event - HD Full

Buzzer: Check box to enable the buzzer when hard drive is full (recommended if the Record Overwrite function is disabled, see Section 4.3).

Email Notify: Check box to enable email notification when HD is full. Email operation requires that valid email settings have been entered in the Network Setting/Email setup screen.

Network Alarm: Check box to send out a network alarm to client PC. (requires PowerCon software and setting up Alarm Server in Network Setup menu)

Alarm Output: This will transmit a signal through the alarm output. It can be set to either "NONE" (not active), "1"(active) or "2"(active).

Output Type: Output action when alarm is triggered.

Timeout: Alarm output lasts for the set time duration.

Permanent: Alarm will be continuously active until user presses the "Enter" key or resets the alarm remotely.

Transparent: Alarm output remains active until event ends.

Trans+Timeout: Alarm output continues until event ends, then continues for the set time duration.

Timeout Duration: The amount of time the alarm condition continues when the HD is full. Duration selectable from 1 to 150 seconds.

Click **Back** button to return to the previous level of menu.

HD Off:

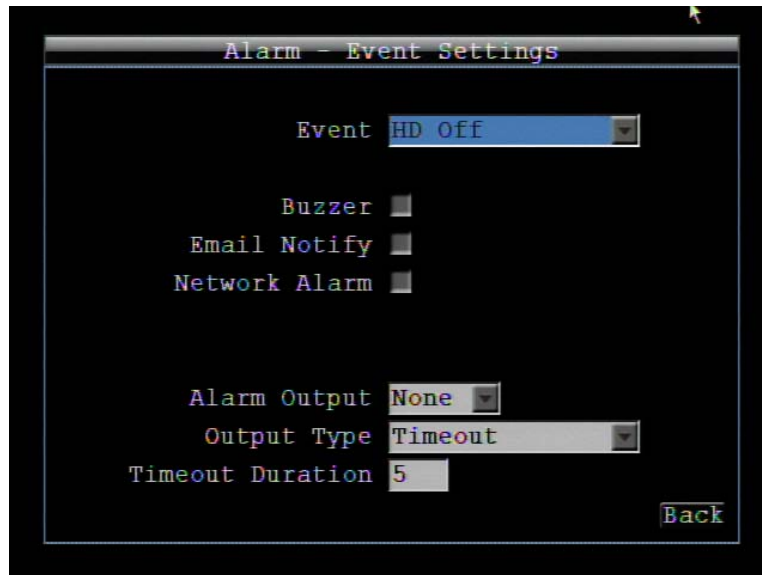

Figure 4-15 Alarm – Event - HD Off

Buzzer: Check box to enable buzzer if the hard drive is turned off (disconnected) or becomes disabled (cannot be detected by the system).

Email Notify: Check box to enable email notification when HD is off. Email operation requires that valid email settings have been entered in the Network Setting/Email setup screen.

Network Alarm: Check box to send out a network alarm to client PC. (requires PowerCon software and setting up Alarm Server in Network Setup menu)

Alarm Output: This will transmit a signal through the alarm output relay. It can be set to either "NONE" (not active), "1"(active) or "2" (active).

Output Type: Output action when alarm is triggered.

Timeout: Alarm output lasts for the set time duration.

Permanent: Alarm will be continuously active until user presses "Enter" key.

Transparent: Alarm output remains active until event ends.

Trans+Timeout: Alarm output continues until event ends, then lasts for the set time duration.

Timeout Duration: The amount of time the buzzer sounds when the HD is off. Duration selectable from 1 to 150 seconds.

Click **Back** button to return to the previous level of menu.

Power Loss:

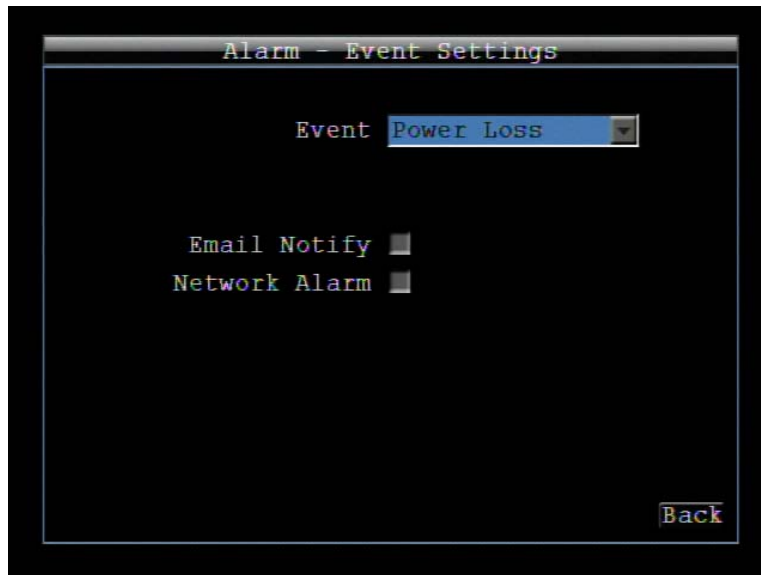

Figure 4-16 Alarm – Event – Power Loss

Email Notify: Check box to enable email notification when power has been restored. Email operation requires that valid email settings have been entered in the Network Setting/Email setup screen.

Network Alarm: Check box to send out a network alarm to client PC when power has been restored. (requires PowerCon software and setting up Alarm Server in Network Setup menu)

NOTE: As alarms and emails cannot be transmitted without power, the log entry is made when power is restored, and any notifications cannot be made until that time.

Click **Back** button to return to the previous level of menu.

Network Loss:

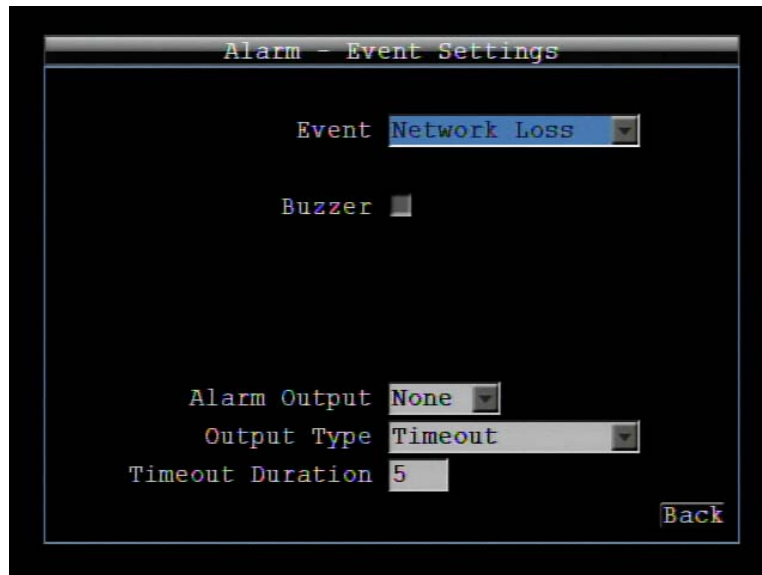

Figure 4-17 Alarm - Event - Network Loss

Buzzer: Check box to enable buzzer when network is lost.

Alarm Output: This will transmit a signal through the alarm output relay. It can be set to either "NONE" (not active), "1" (active) or "2" (active).

Output Type: Output action when alarm is triggered.

Timeout: Alarm output lasts for the set time duration.

Permanent: Alarm will be continuously active until user presses "Enter" key.

Transparent: Alarm output remains active until event ends.

Trans+Timeout: Alarm output continues until event ends, then lasts for the set time duration.

Timeout Duration: The amount of time the buzzer sounds when DVR stops recording. Duration selectable from 1 to 150 seconds.

NOTE: This function only checks the physical connection (link) to the network. Any network behavior that blocks data connectivity (blocked ports, IP addressing errors, etc.) is not detected by this function.

Click **Back** button to return to the previous level of menu.

GPS Loss:

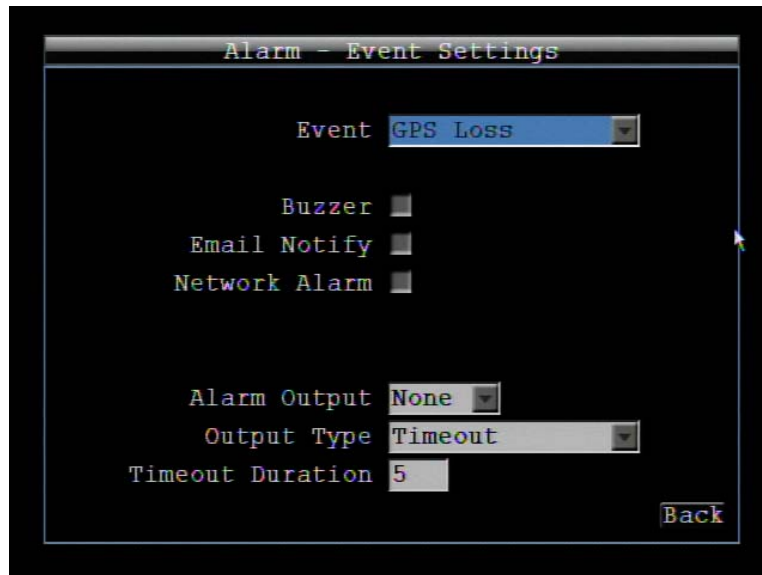

Figure 4-18 Alarm - Event - GPS Loss

Buzzer: Check box to enable buzzer when GPS is lost.

Email Notify: Check box to enable email notification when GPS is lost. Email operation requires that valid email settings have been entered in the Network Setting/Email setup screen.

Network Alarm: Check box to send out a network alarm to client PC. (requires PowerCon software and setting up Alarm Server in Network Setup menu)

Alarm Output: This will transmit a signal through the alarm output relay. It can be set to either "NONE" (not active), "1" (active) or "2" (active).

Output Type: Output action when alarm is triggered.

Timeout: Alarm output lasts for the set time duration.

Permanent: Alarm will be continuously active until user presses "Enter" key.

Transparent: Alarm output remains active until event ends.

Trans+Timeout: Alarm output continues until event ends, then lasts for the set time duration.

Timeout Duration: The amount of time the buzzer sounds when GPS is lost. Duration selectable from 1 to 150 seconds.

NOTE: This function only checks the physical connection (link) to the network. Any network behavior that blocks data connectivity (blocked ports, IP addressing errors, etc.) is not detected by this function.

Click **Back** button to return to the previous level of menu.

4.4.3 Alarm – Video Loss

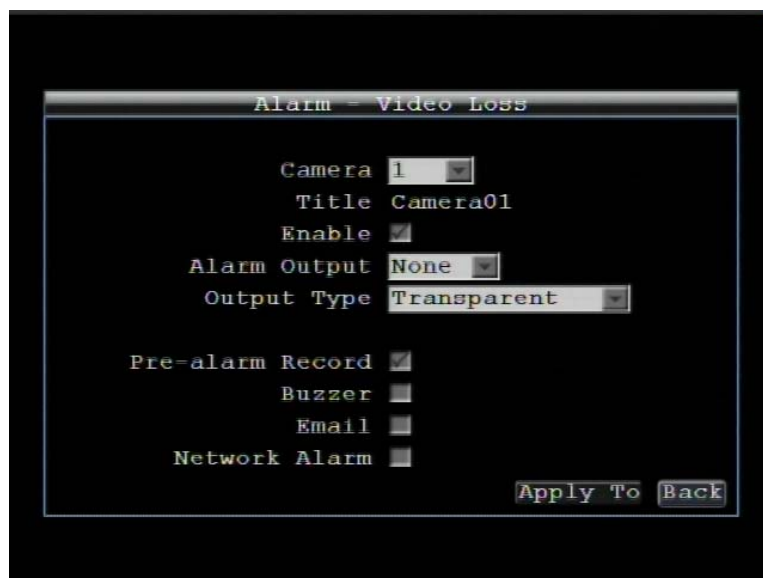

Figure 4-19 Alarm – Video Loss

Camera: Select the camera you wish to configure, "Title" will change to the title name of the selected camera.

Enable: Check box to enable Video Loss detection.

Alarm Output: This will transmit a signal through the alarm output relay. It can be set to either "NONE" (not active), "1" (active) or "2" (active).

Output Type: Output action when alarm is triggered.

Timeout: Alarm output lasts for a set time duration. If this option is selected, a field will appear for setting the duration. Time duration selectable from 1 to 150 seconds.

Permanent: Alarm will remain active until the user presses "Enter" key on front panel.

Transparent: Alarm output continues as long as there is a video loss.

Trans+Timeout: Alarm output continues until the event ends, then continues for a set time duration.

Pre-alarm Record: Check box to start copying recorded video to the hard disk from 5 seconds before the video loss. (Pre-alarm recording rate will follow the "Normal" frame rate setting)

Buzzer: Check box to enable the buzzer when a video loss event occurs.

Email: Check box to enable email notification when a video loss event occurs. Email operation requires that valid email settings have been entered in the Network Setting/Email setup screen.

Network Alarm: Check this box to send out a network alarm to a client PC when video loss occurs. (This feature requires PowerCon software on the client PC and proper settings for the Alarm Server in the Network Setup menu; see Section 4.7.6 Alarm Server for more information.)

Apply To: This button can be used to copy the video loss settings to other cameras. Select which cameras you wish to copy to. "Select All" selects all cameras, "Unselect All" deselects all cameras. Click "OK" to copy the settings or "Cancel" to exit without copying.

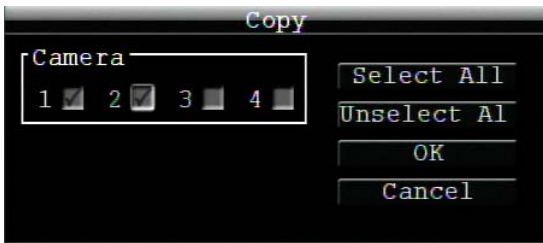

4.4.4 Alarm-G-Sensor Settings



Figure 4-20 Alarm – G-Sensor

G-Sensor: Select On to enable G-Sensor function. Select Off to disable G-Sensor function.

XY Axial Trigger Value: Set XY Axial trigger value, alarm will be triggered when acceleration reaches this value in horizontal direction with respect to the horizon.

Z Axial Trigger Value: Set Z Axial trigger value, alarm will be triggered when acceleration reaches this value in vertical direction with respect to the horizon.

Alarm Output: This will transmit a signal through the alarm output relay. It can be set to either "NONE" (not active), "1" (active) or "2" (active).

Output Type: Output action when alarm is triggered.

Timeout: Alarm output lasts for the set time duration.

Permanent: Alarm will be continuously active until user presses "Enter" key.

Transparent: Alarm output remains active until event ends.

Trans+Timeout: Alarm output continues until event ends, then lasts for the set time duration.

Timeout Duration: The amount of time the buzzer sounds when GPS is lost. Duration selectable from 1 to 150 seconds.

Pre-alarm Record: Check box to start copying recorded video to the hard disk from 5 seconds before the video loss. (Pre-alarm recording rate will follow the "Normal" frame rate setting)

Email Notify: Check box to enable email notification when GPS is lost. Email operation requires that valid email settings have been entered in the Network Setting/Email setup screen.

Network Alarm: Check box to send out a network alarm to client PC. (requires PowerCon software and setting up Alarm Server in Network Setup menu)

Click **Back** button to return to the previous level of menu.

4.4.5 Alarm-GPS Speed



Figure 4-21 Alarm – GPS Speed

Speed Unit: If the speed is being recorded from the GPS receiver, the desired speed display units must be selected. Select GPS speed unit from KPH and MPH. Selecting MPH converts the GPS signal to display speed in miles per hour.

GPS Speed: Select whether to record the vehicle speed or not.

Speed Higher Limit: Set the speed to determine at which level the alarm will be triggered.

Click **Back** button to return to the previous level of menu.

4.4.6 Alarm-GPS Event Action

Press **GPS Action** to enter GPS Event Action Menu.

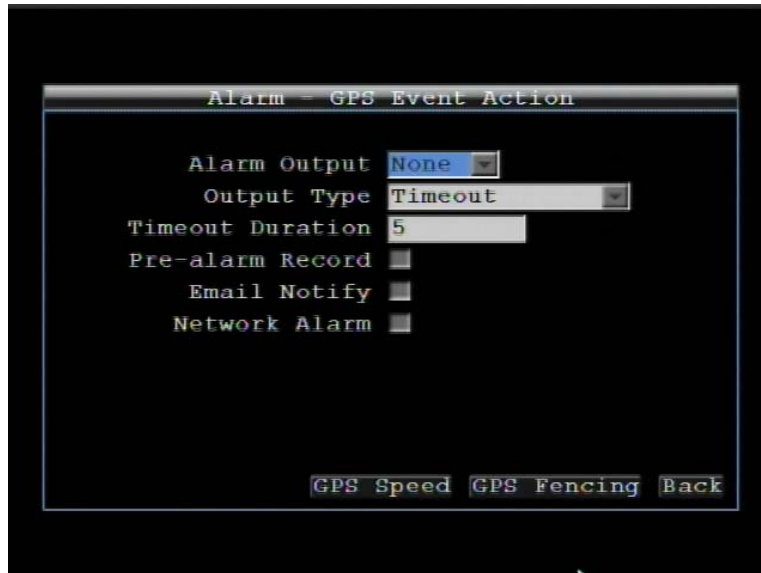

Figure 4-22 Alarm – GPS Event Action

Alarm Output: This will transmit a signal through the alarm output relay. It can be set to either “NONE” (not active), “1” (active) or “2” (active).

Output Type: Output action when alarm is triggered.

Timeout: Alarm output lasts for the set time duration.

Permanent: Alarm will be continuously active until user presses “Enter” key.

Transparent: Alarm output remains active until event ends.

Trans+Timeout: Alarm output continues until event ends, then lasts for the set time duration.

Timeout Duration: The amount of time the buzzer sounds when GPS event occurs. Duration selectable from 1 to 150 seconds.

Pre-alarm Record: Check box to start copying recorded video to the hard disk from 5 seconds before the video loss. (Pre-alarm recording rate will follow the “Normal” frame rate setting)

Email Notify: Check box to enable email notification when GPS event occurs. Email operation requires that valid email settings have been entered in the Network Setting/Email setup screen.

Network Alarm: Check box to send out a network alarm to client PC. (requires PowerCon software and setting up Alarm Server in Network Setup menu)

Click **Back** button to return to the previous level of menu.

4.4.7 Alarm-GPS Fencing

Press **GPS Fencing** to enter GPS Fencing Menu.



Figure 4-23 Alarm – GPS Fencing

GPS Alarm: Select “On” to enable GPS alarm. Select “Off” to disable GPS alarm function.

GPS Border Type: Set to a circle or rectangle and dynamic prompts for Latitude and Longitude appear.

Center Latitude: Set the latitude if border type is circle.

Center Longitude: Set the latitude if border type is circle.

Radius: If GPS border type is circle, this option defines radius. Select radius unit from Km and Mi.

Upper Left Latitude.: Set Upper Left Latitude if border type is rectangle.

Upper Left Longitude: Set Upper Left Longitude if border type is rectangle.

Lower Right Latitude: Set Lower Right Latitude if border type is rectangle.

Lower Right Longitude: Set Lower Right Longitude if border type is rectangle.

Click **Back** button to return to the previous level of menu.

4.5 Date/Time Setting

Figure 4-24 is a screenshot of the **DATE/TIME SETTING MENU**. This menu is for setting up the date/time parameters for the DVR.

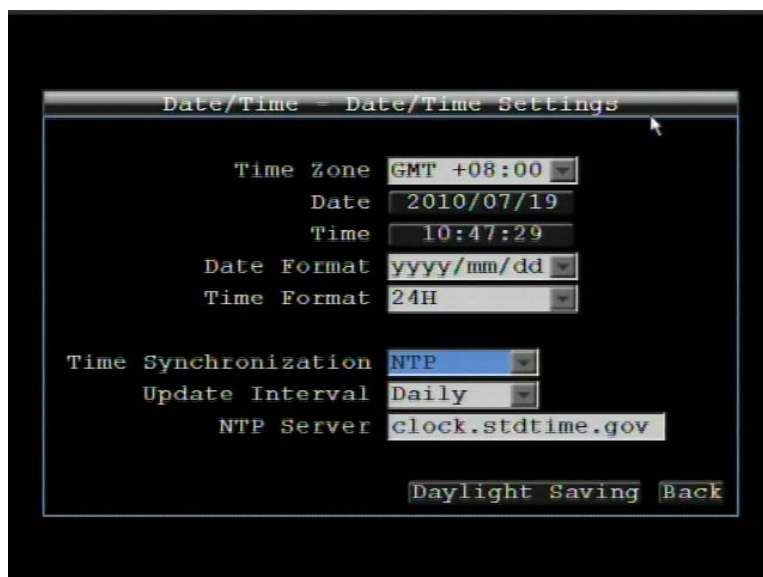

Figure 4-24 Date/Time Settings

4.5.1 Date/Time Settings

Time Zone: Set the time zone that the DVR adjusts to when updating from the time server.

Date: Set current Date.

Time: Set current Time.

Date Format: Choose date format from yyyy/mm/dd, dd/mm/yyyy, and mm/dd/yyyy.

Time Format: Change time format between 12H and 24H mode.

Time Synchronization: Select "Off", "NTP" or "GPS" for time synchronization.

If selecting "NTP", you will be able to do the following NTP settings:

Update Interval: The frequency that the system automatically updates the time via the NTP server. Select Daily, Weekly, or Monthly.

NTP Server: Displays the time server address that the DVR uses for time synchronization. Requires operating network configuration and WAN or LAN access to a compatible NTP server.

To find a compatible NTP address, please follow these steps:

- a) Go to a PC that is connected to the internet.
- b) Click on "START" -> "RUN" -> type "command" and press "OK".

c) In the DOS Prompt, type "ping pool.ntp.org" to find out the IP address of an NTP Server.

If selecting "GPS", you will be able to do the following setting:

Update Interval: The frequency that the system automatically updates the time via the NTP server. Select Daily, Weekly, or Monthly.

Click **Back** button to return to the previous level of menu.

4.5.2 Daylight Saving

Click **Daylight Saving** button to set up daylight saving parameters

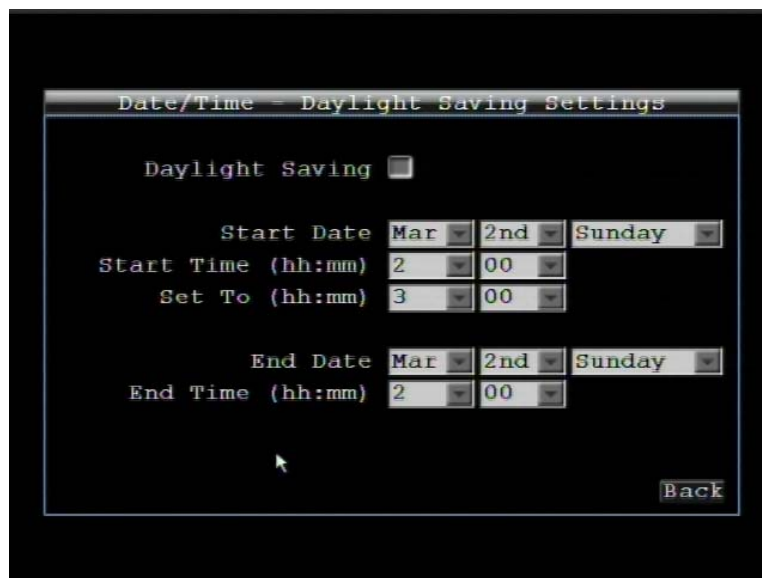

Figure 4-25 Date/Time Settings-Daylight Saving

Daylight Saving: Check the box to enable automatic daylight saving time adjustment.

Start Date: Set the start date for daylight saving time.

Start Time (hh:mm): Set the time when daylight saving time begins.

Set To (hh:mm): This is what the time will change to when daylight saving begins. For most regions, this will be one hour ahead of the "Start Time".

End Date: Set the end date for daylight saving time.

End Time (hh:mm): Set the time when daylight saving time ends.

The time change difference on the End Date will be the same as the difference between the Start Time and End Time entered for the Start Date (typically 1 hour as in the example shown).

Click **Back** button to return to the previous level of menu.

4.6 Display

Figure 4-26 is a screenshot of the **DISPLAY SETTING MENU**. This menu will walk you through the Main Monitor On-Screen Display (OSD) and Main Monitor Sequential setup.

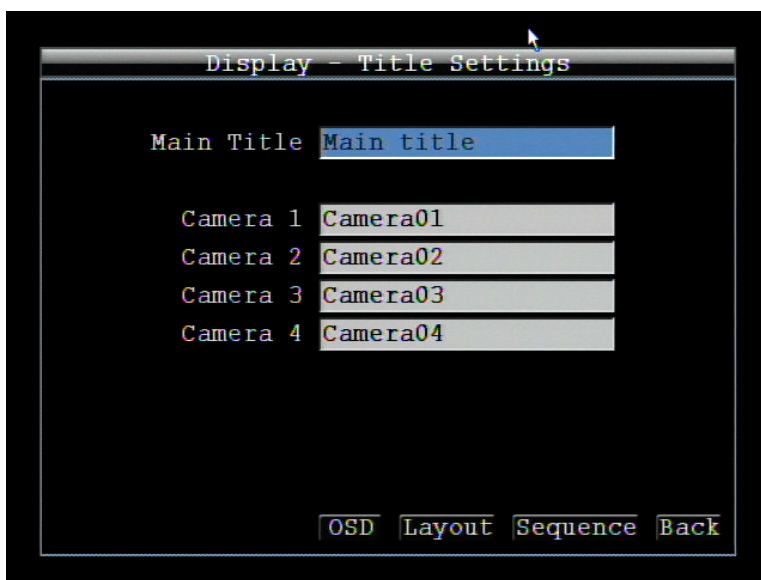

Figure 4-26 Display Settings

4.6.1 Title

Main Title: Input the main title by using the on-screen keyboard. Maximum text length is 16 characters.

Camera 1~4: Input camera name for camera 1~4 by using the on-screen keyboard. Maximum text length is 16 characters.

4.6.2 Monitor On Screen Display

Click **OSD** button to set up OSD parameters.



Figure 4-27 Display-OSD

Main Monitor

Main Title: Check the box to display main title.

Camera Title: Check the box to display camera titles for main monitor.

Date/Time: Check the box to display current date/time.

Playback Date/Time: Check the box to display playback date/time.

Playback Status: Check the box to display playback status.

Event Status: Check the box to display event status.

HDD Status: Check the box to display hard drive status.

GPS Status: Check the box to display GPS status.

Network Loss: Select Disabled, LAN, Wireless and 3G.

4.6.3 Layout

Click **Layout** button to set up Layout parameters.

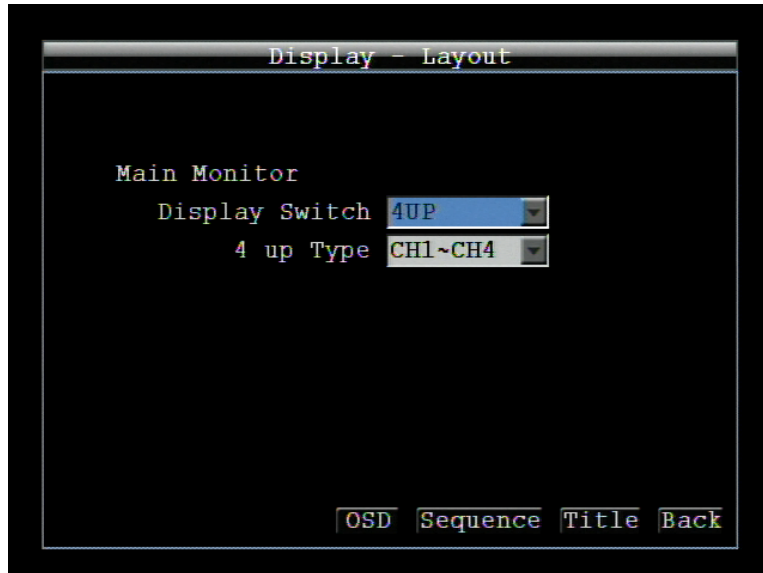

Figure 4-28 Display-Layout

Main Monitor

Display Switch: Select display switch for main monitor from 1 UP, 4 UP and SEQ.

4 Up Type: Layout type for the display switch.

4.6.4 Sequence

Click **Sequence** button to set up Sequence parameters.

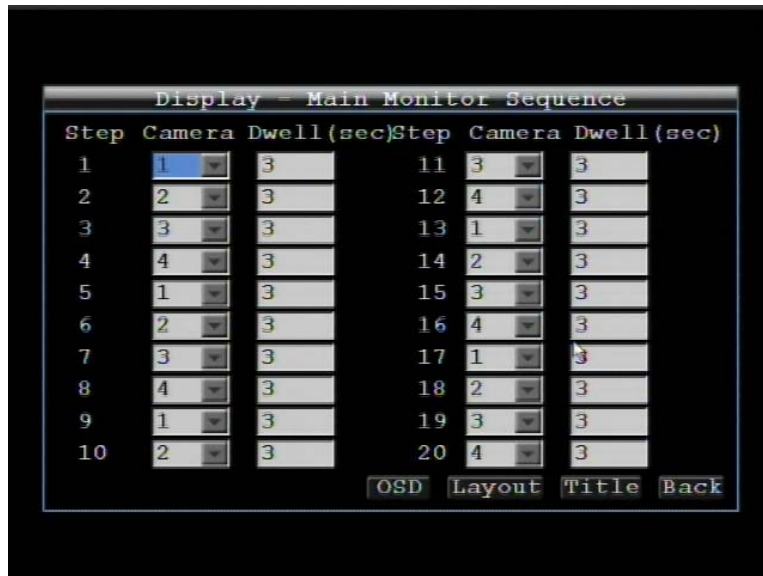

Figure 4-29 Display-Sequence

Step: Sequence order. For reference.

Camera: Select which camera appears in the current step.

Dwell (sec): Set the dwell time for each step. Sequence dwell time can be set from 0 to 99 seconds.

Sequence repeats continuously from steps 1 through 20 until interrupted.

Click **Back** button to return to the previous level of menu.

4.7 NETWORK SETTING

Figure 4-30 is a screenshot of the **NETWORK SETTING MENU**. This menu is for configuring the DVR for a network connection.

NOTE: Since every Network Configuration is different, please check with your Network Administrator or ISP to see if your DVR should use specific IP addresses and/or port numbers.



Figure 4-30 Network Menu

4.7.1 LAN Settings

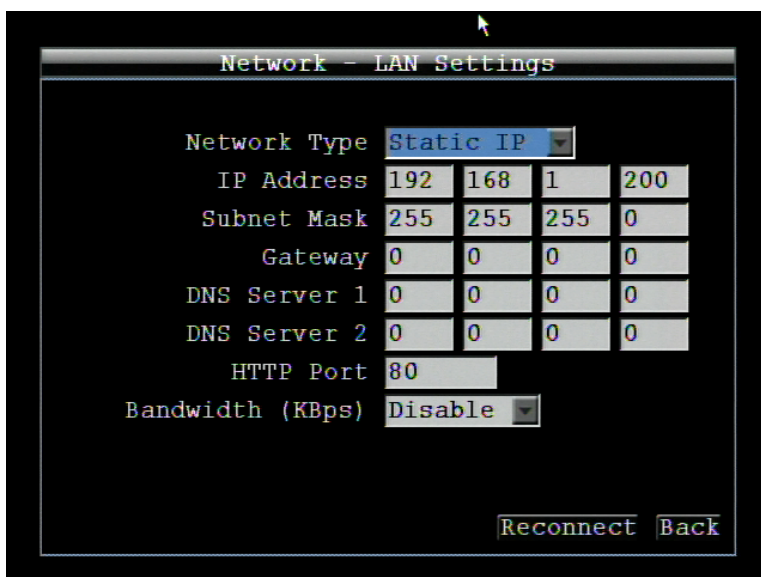

Figure 4-31 Network Menu - LAN

Network Type:

Static IP: User can set a fixed IP for network connection.

DHCP: DHCP server in LAN will automatically assign IP configuration for the network connection

IP address: This field shows the DVR's current IP Address. A static IP address must be set manually. If DHCP or PPPoE is selected, this value will be assigned automatically.

Subnet Mask: This field shows the subnet mask for your network so the DVR will be recognized within the network. If DHCP or PPPoE is selected, this value will be assigned automatically.

Gateway: This field shows the gateway on your network for the DVR to use when communicating with any devices not on the local network. If DHCP or PPPoE is selected, this value will be assigned automatically.

DNS Server 1: This field shows the primary DNS server for your network. If DHCP is selected and an internet connection is available, this value should be assigned automatically. This field must have a valid DNS address in order to use the DDNS feature (see Sections 4.7.5 and 7 DDNS for more detail).

DNS Server 2: This field shows the secondary DNS server for your network.

HTTP Port: Port number for HTTP/WEB communication.

Additional information:

1. Set up the DVR Network Menu according to the instructions detailed in the Networking chapter of this DVR's manual.
 - a. If using DHCP, all settings will be detected automatically. While DHCP is a useful tool for determining the network settings, if you set up your DVR in this manner *its IP address may change at different times for different reasons*, particularly after a power failure. *If the IP address of the DVR changes, you may have difficulties accessing your DVR locally and/or remotely. It is strongly recommended that you assign a fixed (static) IP address to your DVR*, and that in order to avoid address conflicts the IP address assigned be outside of the DHCP range of addresses your router issues to DHCP clients. Please do not set the DHCP address issued to the DVR by the router as its static IP address unless you take specific steps that program your router to prevent such address conflicts.
 - b. If using a Fixed IP (**recommended**), you will need to input the information manually. In order for DDNS to work, you must enter valid data, compatible with your network, for all four of the network setting fields: IP address, subnet mask, default gateway and the DNS Address (depending on your network hardware and configuration this may be the IP address of your router/gateway, or it may be the actual IP address of the local DNS server). The DNS server IP is required because your DNS server provides critical information necessary for the DVR to communicate with the DDNS server.

You can obtain the actual DNS IP from your Internet Service Provider (ISP); or, from a PC located on the same LAN as the DVR, go to <http://www.dnsserverlist.org/> to obtain a list of the IP addresses of their recommendation of the best servers to use for your location.

2. If you are connecting through a router, make sure that you have 'opened up' all the required network ports in the *port forwarding* section of your router's setup options. That is, you have directed the router to send any incoming traffic using those IP ports to the LAN IP address of the DVR. Useful information about router port forwarding can be found at www.portforward.com . Different routers may use different terms for port forwarding function. For instance, D-Link calls it *virtual server*, Netopia calls it *pinholes*.

The default port for the EMV400 is: 80

Note: Port 80 is the default port used for web browsing. Because of this, in order to prevent the average user from hosting a web server, *most ISPs BLOCK traffic using port 80* from reaching the average site. If you only plan to view your DVR on a LAN, you can use port 80, and don't have to concern yourself with DDNS or routers. However, if you desire remote access to your DVR, perhaps using DDNS (optional), you MUST select functional ports and set up the port forwarding in your router. Other ports, such as 8080 and 8000 are sometimes blocked by ISPs as well.

What port(s) should be used? There are 65,535 valid IP ports to choose from. These are broken down into three groups:

- Well Known Ports 0 thru 1023
- Registered Ports 1024 thru 49151
- Dynamic and/or Private Ports 49152 thru 65535

So, rather than encounter a port conflict by choosing a port commonly used for another purpose (like port 25 for SMTP mail or port 448 for secure sockets), choose an 'unusual' port number. For example, add 50,000 to your house number: 50,123 is less likely to lead to a port conflict. For a list of the known and registered ports, see <http://www.iana.org/assignments/port-numbers>

Bandwidth (Kbps): Specify, disabled / 128 K / 256 K / 512 K / 768K / 1M / 3M bps. This is the maximum bandwidth that the DVR is allowed to use on the network. This is a useful function when connecting the DVR to busy or heavily loaded networks, or when accessing the DVR(s) over a WAN.

Click  button to start LAN reconnection.

Click  button to return to the previous level of menu.

4.7.2 Wireless Settings

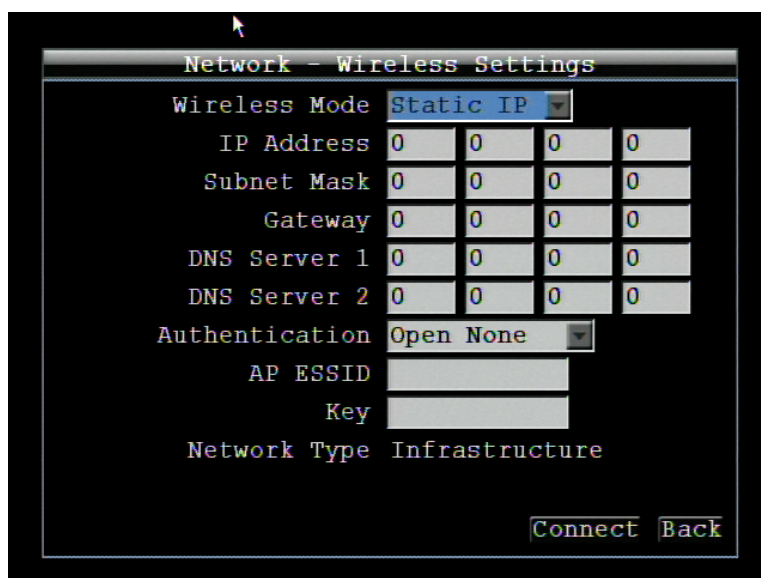

Figure 4-32 Network Menu – Wireless

Wireless Mode: Select wireless mode from Static IP, DHCP or disabled.

IP address: This field shows the DVR's current IP Address. A static IP address must be set manually. If DHCP or PPPoE is selected, this value will be assigned automatically.

Subnet Mask: This field shows the subnet mask for your network so the DVR will be recognized within the network. If DHCP or PPPoE is selected, this value will be assigned automatically.

Gateway: This field shows the gateway on your network for the DVR to use when communicating with any devices not on the local network. If DHCP or PPPoE is selected, this value will be assigned automatically.

DNS Server 1: This field shows the primary DNS server for your network. If DHCP is selected and an internet connection is available, this value should be assigned automatically. This field must have a valid DNS address in order to use the DDNS feature (see Sections 4.7.5 and 7 DDNS for more detail).

DNS Server 2: This field shows the secondary DNS server for your network.

HTTP Port: Port number for HTTP/WEB communication.

Authentication: Selectable "Open None" or "Open WEP".

AP ESSID: Name of the wireless network the DVR is configured for. The field accepts up to 32 alphanumeric characters. The name must be exactly the same as the one used in the wireless access point or the connection will not be established.

Key: Entering a key in either hexadecimal or ASCII format.

Network Type: Infrastructure. "Infrastructure" makes the DVR connect to the WLAN via an Access Point.

Click **Connect** button to start wireless connection.

Click **Back** button to return to the previous level of menu.

4.7.3 Mobile Connection Settings

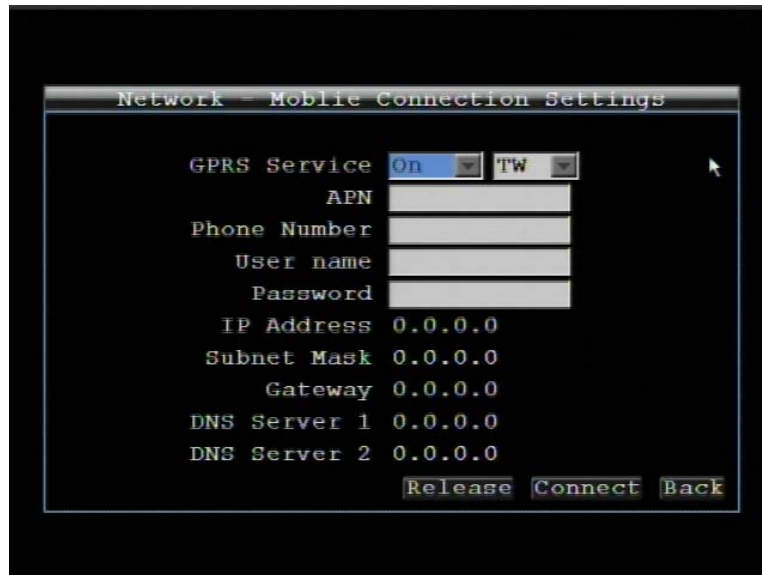

Figure 4-33 Network Menu – Mobile Connection

GPRS Service: Select "On" to enable GPRS service. Select "Off" to disable GPRS function.

APN (Access Point Name): By local ISP setting.

Phone Number: Input the phone number to dial for mobile connection.

User Name: Input the user name required for mobile connection.

Password: Input the password required for mobile connection.

IP Address: The IP address provided by ISP will be displayed.

Subnet Mask: The Subnet Mask provided by ISP will be displayed.

Gateway: The gateway provided by ISP will be displayed.

DNS Server 1: The primary DNS server provided by ISP will be displayed.

DNS Server 2: The secondary DNS server provided by ISP will be displayed.

Click **Release** button to stop mobile connection.

Click **Connect** button to start mobile connection.

Click **Back** button to return to the previous level of menu.

4.7.4 Email Settings

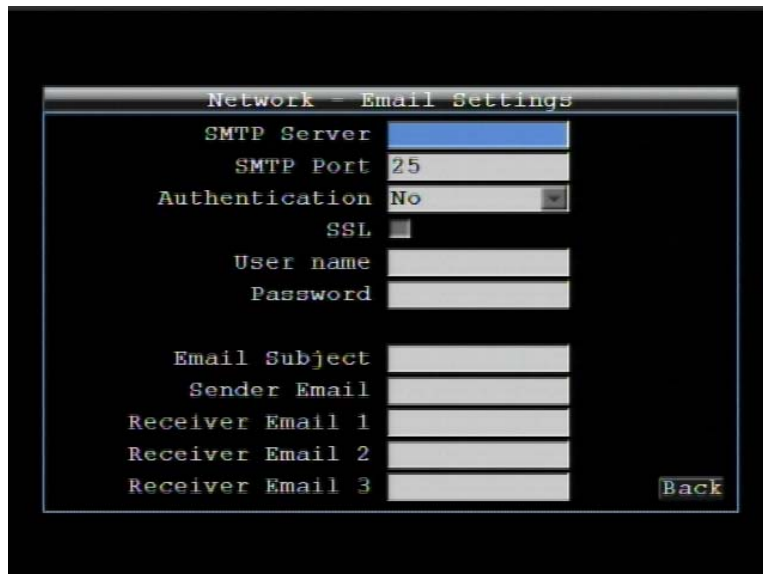

Figure 4-34 Network Menu – Email Settings

SMTP Server: Assign the SMTP (e-mail) server's name.

NOTE: For more reliable email service, use the server's IP address.

SMTP Port: Assign the port number used by the SMTP server.

Authentication: Check this box if the SMTP server requires authentication (user name / password).

SSL: Check the box if mail server needs communication to be encrypted by SSL.

User name: Input the login user name if the SMTP server requires authentication.

Password: Input the password if the SMTP server requires authentication.

Email Subject: Input Email subject.

Sender Email: Input the e-mail address of the sender (the DVR). Sender's e-mail address has to match the user name and password above.

Receiver Email 1: Input the first e-mail address that event messages are sent to.

Receiver Email 2: Input the second e-mail address that event messages are sent to.

Receiver Email 3: Input the third e-mail address that event messages are sent to.

Click **Back** button to return to the previous level of menu.

4.7.5 DDNS Settings

DDNS Server: Select either "EverfocusDDNS" or "www.dyndns.org" as the DDNS provider. If DDNS will not be used, simply select "Disable".

EverfocusDDNS

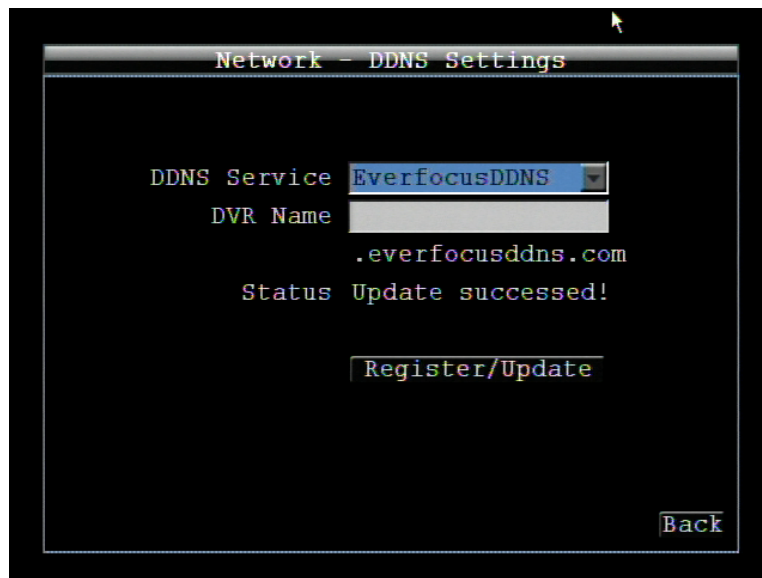

Figure 4-35 Network Menu – DDNS Settings

DVR Name: Input the desired name for the DVR

Register/Update: Click the button to submit and register the name to the Everfocus server.

The DDNS name you choose must be unique; that is, it must not already be in use. Please go to the website <http://everfocusddns.com> and check that the name you wish to use is available.

PLEASE NOTE: The name of the DVR **cannot include a space, or a dot (period) or any special characters** particularly ~ ! @ # \$ % ^ & * () + < > " ; : , , _

In the DVR's Network Menu above, go to DDNS. Choose "everfocusddns.com" for the Server and put in your chosen name (verified available and without special characters) for DVR Name/hostname.

Press the Submit/Update button to synchronize the DVR with the DDNS server. You should see an indication of "Success" on the screen. If you see "Could Not Find Server" or any other error message instead, double-check your network settings and DDNS name and resubmit the DDNS name until you get "Success". You should now be able to connect by typing in the host name you created.

Example: <http://hostname.everfocusddns.com>

It is not necessary to append the HTTP port number to the DDNS name. The EverFocus DDNS server not only keeps track of your DVR's IP address, it keeps track of the ports too!

www.dyndns.org



Figure 4-36 Network Menu – DDNS- www.dyndns.org

Host name: Host name created through the dyndns account.

User name: User name of the dyndns account.

Password: Password of the dyndns account.

Note: For more details on DDNS setup, please see "Chapter 7 - Everfocus DDNS Setup".

Click **Back** button to return to the previous level of menu.

4.7.6 Alarm Server Settings

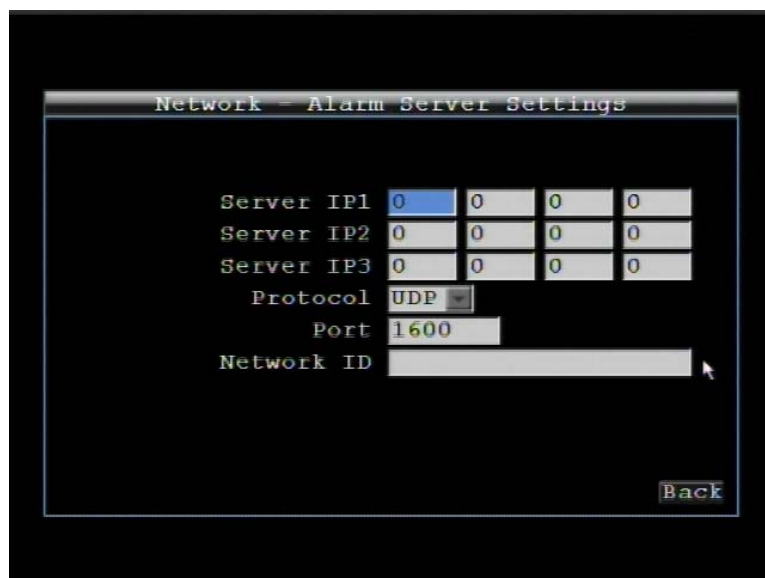

Figure 4-37 Network Menu – Alarm Server

This menu defines the parameters for communicating with a PC.

Server IP1~3: IP address of client PC. The network alarm can be transmitted to up to 3 addresses.

Protocol: Select the protocol type for alarm transmission:

UDP: User Datagram Protocol

TCP: Transmission Control Protocol

Port: Select the transmission port for network alarm messages

Network ID: The network ID is an identifier for the alarm transmitter (DVR sending the alarm).

Click **Back** button to return to the previous level of menu.

4.8 SYSTEM

4-39 is a screenshot of the **SYSTEM MENU**. This menu is for setting up the general system parameters for the DVR.



Figure 4-38 System Menu

4.8.1 User

User Menu is where you can add or delete different login IDs on the system as well as set access levels. See the charts below for a listing of the rights associated with each access level.

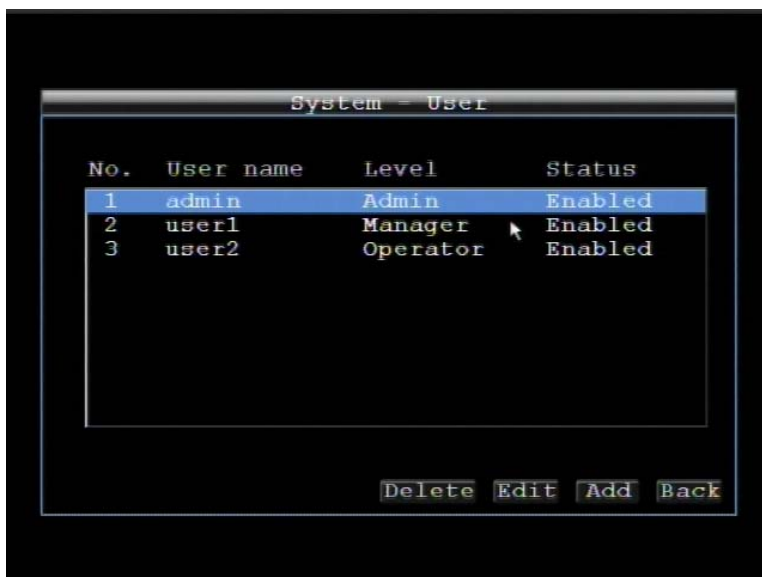

Figure 4-39 System-User

Add

Click "Add" button to add a new user. Set the name (case-sensitive), password, access level and status. Press "Add" button to confirm a new user or "Cancel" to exit without making changes.

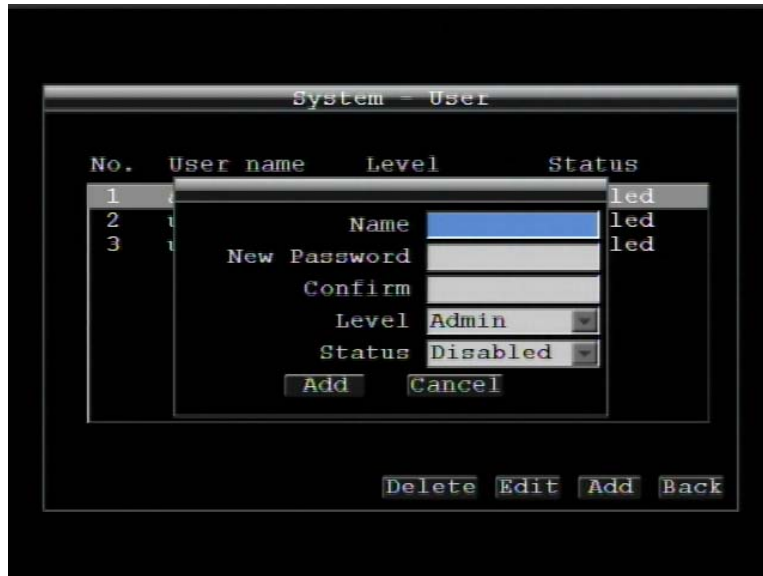

Figure 4-40 System-User-Add

Edit

Click "Edit" button to make changes to an existing user account. Press "Save" button to save changes or "Cancel" to exit without making changes.

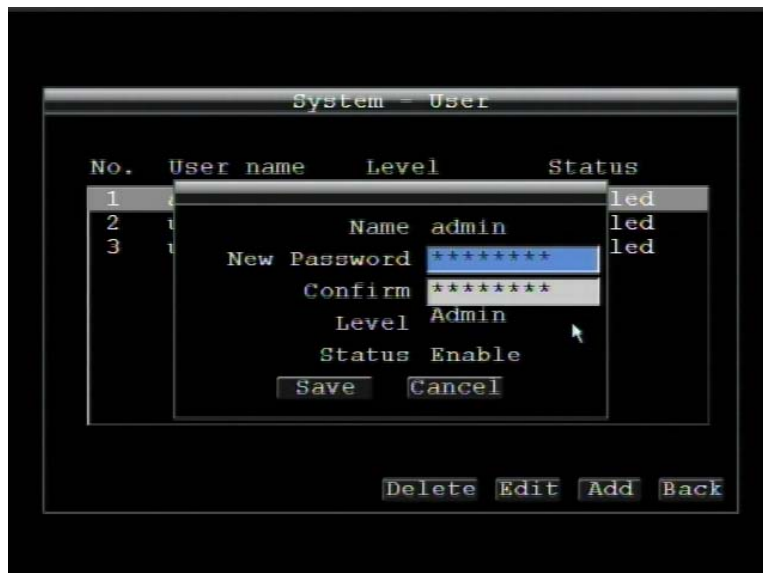

Figure 4-41 System-User-Edit

There are three system access levels. The following charts show the rights of each level.

Local

Local		Admin	User	Guest
Live View		0	0	0
Copy		0	0	0
Playback		0	0	X
Configuration	Camera	0	0	X
	Record	0	0	X
	Alarm/GPS	0	X	X
	Date/Time	0	0	X
	Display	0	X	X
	Network	0	X	X
	System	0	X	X
	Information	0	0	0

Web

Web	Admin	User	Guest
Live View	0	0	0
Copy	0	0	0
Search & Playback	0	0	X
Camera	0	0	X
Record	0	0	X
Alarm/GPS	0	X	X
Date/Time	0	0	X
Display	0	X	X
Network	0	X	X
System	0	X	X
Information	0	0	0

1. Only USER submenu; only access to change own password, and to access operator ID's
2. Only USER submenu; only ability to change own password.

4.8.2 I/O Control

Figure 4-43 is a screenshot of the I/O Control Setting Menu. This menu is used to define the settings for controlling the DVR through RS485, and for DVR control of attached PTZ cameras.



Figure 4-42 System-I/O Control-RS232

Select Bus Name from RS-232, RS-485 and GPS.

RS232

Baud Rate: This field is to set the speed at which is used to transmit instruction or information through the RS232 port on the DVR. There are eight different speeds: 1200 BPS, 2400 BPS, 4800 BPS, 9600 BPS, 19200 BPS, 38400 BPS, 57600 BPS and 115200 BPS.

Data Bit: This field is the data bit at which you will be transferring. There are two settings for this option: 8 or 7.

Stop Bit: This field is to set the stop bit for the RS232 connection. There are two different stop bits, 1 or 2.

Parity: This field is to select the parity level at which you will be connected. You can choose between None, Odd, or Even parity levels.

Click **Back** button to return to the previous level of menu.

RS485



Figure 4-43 System-I/O Control-RS452

Baud Rate: The speed used to transmit instructions or information through the RS485 port on the DVR. Choose from the following speeds: 1200, 2400, 4800, 9600, 19200, 38400, 57600, 115200 BPS.

Data Bit: The number of data bits used in a data packet or word. This can be set to 8 or 7.

Stop Bit: This field is to set the number of stop bits indicating the end of a data packet. This can be set to 1 or 2.

Parity: This selects the transmission error checking rule. Choose either None, Odd, or Even.

PTZ Protocol: Select PTZ protocol, choose from the following protocols: Transparent, Pelco D, Pelco P, or Everfocus. (*NOTE: all cameras on the bus must use the same protocol*)

485 ID: This is the ID used by the EKB500 to send commands to the DVR. On an RS485 connection, every device (PTZ, DVR and controller) must be assigned a unique ID number between 0 and 127.

Control

One remote control can be used to operate several DVRs. The DVR to be addressed is selected by pressing the key corresponding to its ID number on the remote control.

Remote Controller ID: ID used by the remote control to select this DVR.

Click **Back** button to return to the previous level of menu.

GPS

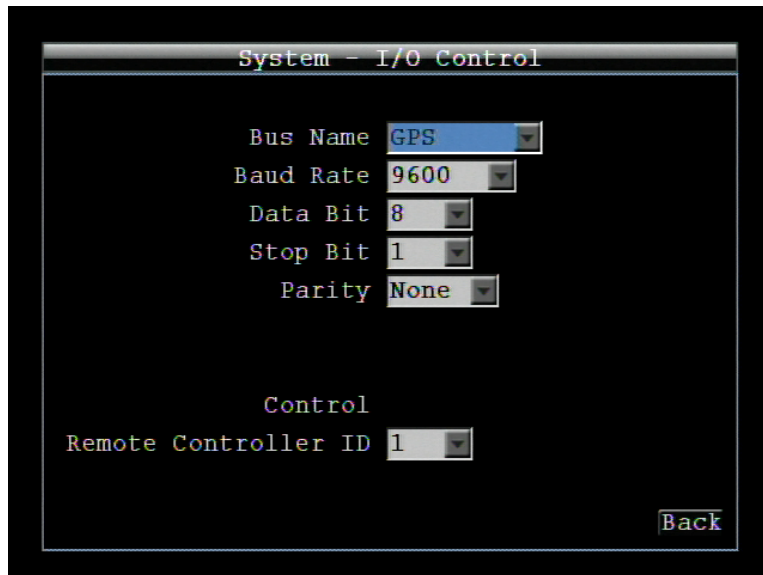

Figure 4-43 System-I/O Control-GPS

Baud Rate: The speed used to transmit instructions or information through the GPS on the DVR. Choose from the following speeds: 1200, 2400, 4800, 9600, 19200, 38400, 57600, 115200 BPS.

Data Bit: The number of data bits used in a data packet or word. This can be set to 8 or 7.

Stop Bit: This field is to set the number of stop bits indicating the end of a data packet. This can be set to 1 or 2.

Parity: This selects the transmission error checking rule. Choose either None, Odd, or Even.

Control

One remote control can be used to operate several DVRs. The DVR to be addressed is selected by pressing the key corresponding to its ID number on the remote control.

Remote Controller ID: ID used by the remote control to select this DVR.

Click **Back** button to return to the previous level of menu.

4.8.3 DISK Info

Figure 4-44 is a screenshot of the **DISK MENU**. This menu is used to review the DVR's hard drive settings and status. No values in this screen can be changed by the operator.



Figure 4-44 System-Disk

Record Time (Start): Shows earliest recorded time on the DVR.

Record Time (End): Shows latest or most current recorded time on the DVR.

Disk Info

Disk: Displays Disk number.

Disk Temperature: Displays current disk temperature of the selected disk.

Health Status: Displays current status of the selected disk.

Disk Size/Total: Shows total disk size of the selected disk.

Disk Size/Usage: Shows percentage of used disk space for the selected disk.

Format: Click  button to format the whole HDD. **WARNING: This will effectively ERASE the ENTIRE HDD!!**

Click  button to return to the previous level of menu.

4.8.4 LOG

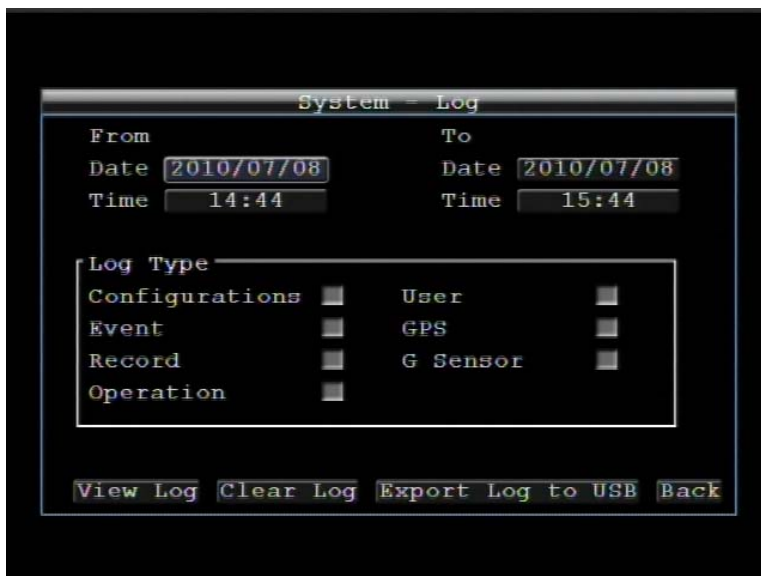

Figure 4-46 System-Log

This screen is used to choose, display and/or export log entries.

From

Date: Select starting date of log to be displayed.

Time: Select starting time of log to be displayed.

To

Date: Select end date of log to be displayed.

Time: Select end time of log to be displayed.

Log Type:

Configurations: to see log entries related to configuration changes.

Event: to see log entries related to events.

Record: to see log entries related to recording changes.

Operation: to see log entries related to operation changes.

User: to see log entries related to user access.

GPS: to see log entries related to GPS changes.

G Sensor: to see log entries related to G Sensor changes.

View Log: Press **View Log** button to view the log. See Figure 4-46 for more detail.

Clear Log: Press **Clear Log** button to clear the log.

Export Log to USB: Press **Export Log to USB** button to export log data to USB.

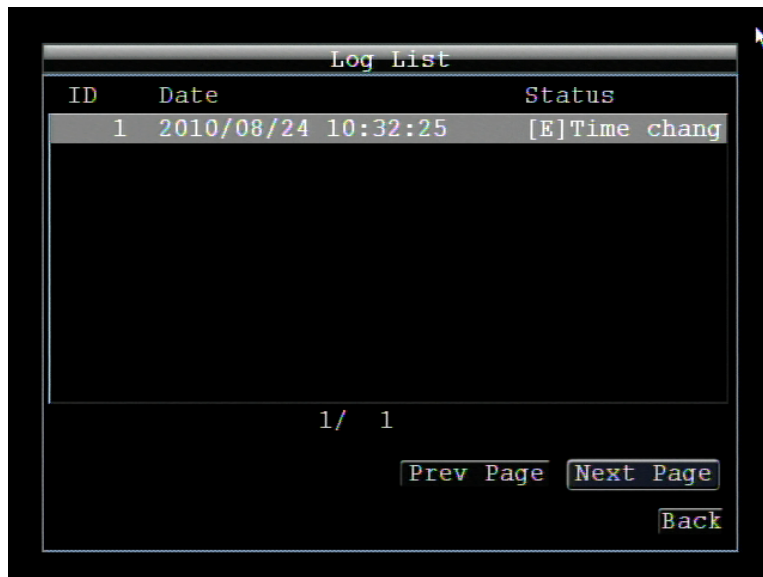

Figure 4-47 Log List

Prev Page: Go to the previous page of log.

Next Page: Go to the next page of log.

Close: Close the window

Click **Back** button to return to the previous level of menu.

4.8.5 SETTINGS

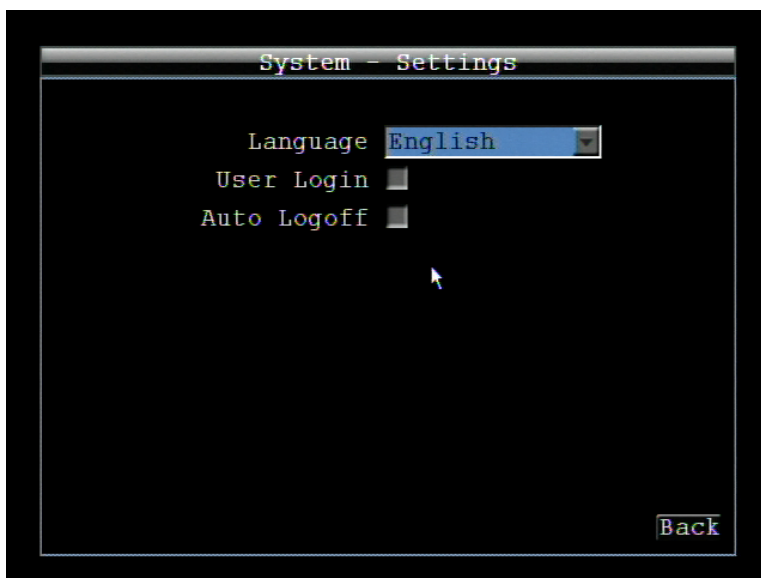

Figure 4-48 System-Settings

Audio Output Channel: Select audio output channel.

Language: Choose which language the DVR uses. The available languages may vary based on region.

User Login: Check this box to require user login for menu access from the front panel. When this is disabled, no username or password is required to access the system from the front panel, and all users operate with ADMIN rights from the front panel.

Auto Logoff: Check this box to automatically logoff the current front panel user after 3 minutes of inactivity.

Click **Back** button to return to the previous level of menu.

4.8.6 SERVICE



Figure 4-49 System-Service.

Firmware

Current Firmware Version: Displays the current version.

Upgrade from USB: Press "Upgrade" to upgrade the firmware.

***NOTE:** To perform a Firmware Upgrade, you will need to connect a USB flash device with the desired firmware. Do not disconnect the USB device or turn off the power to the unit during the upgrade; this can cause the system to fail to recover, requiring factory service to repair.*

Configurations

Load Factory Default: Click "Load" to restore all menu settings to the default values. User Account, Network IP Settings, and Time are not affected.

Load From USB: Click "Load" to upload saved DVR configuration settings from a USB flash device.

Save To USB: Click "Save" to save the current DVR configuration settings to a USB flash device.

Click **Back** button to return to the previous level of menu.

4.9 INFORMATION

Figure 4.50 is a screenshot of the **INFORMATION MENU**. This menu displays important (read only) system information.

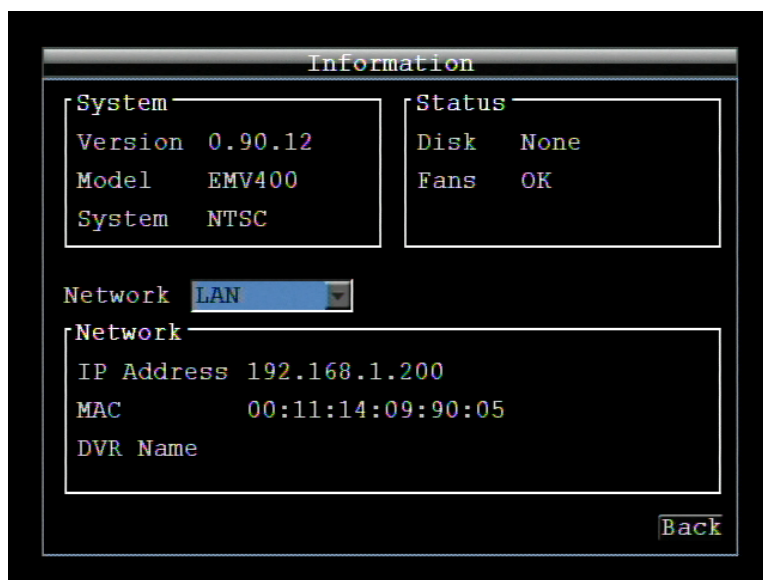

Figure 4-50 Information

System

Version: Displays firmware version number.

Model: Displays DVR model number.

NTSC/PAL: Displays current video format selected based video format on Camera 1 input at boot up.

Status

Disk: Displays status of the installed disk(s); normal disk operation is indicated by "OK".

Fans: Displays fan status; normal fan operation is indicated by "OK".

Network (Select network type from LAN, Wireless and Mobile)

IP Address: Displays the DVR's current IP Address as set in the Network or Express Setup screen.

MAC: Unique address of the DVR's internal network card. This option cannot be changed.

DVR Name: Displays DVR DDNS name if configured.

Network ID: The ID number for the alarm network as set in the Alarm Server screen.

Click **Back** button to return to the previous level of menu.

5 Networking Overview

This chapter will give you a basic instruction on how to set up the DVR for network connection. It is highly recommended that you have a working knowledge of what a network is and how it works. This will be helpful in completing the networking process.

5.1 Introduction to TCP/IP

TCP/IP is the group of protocols used by the Internet and most Local Area Networks (LANs) throughout the world. In TCP/IP, every computer or other communications device that is connected to the network has a unique IP address. By doing this you are giving your device a unique address similar to the address of your house. An IP address is composed of four octets (numbers in the range of 0 to 255) separated by decimal points. The IP address is used to uniquely identify a host or computer on the LAN. For example, one computer on a network could have an IP address of 192.168.1.127.

You should never give two or more devices the same exact IP address, but the first three octets of an IP address is often the same for all computers in the local area network. For example, if a total of 253 computers exist in a single LAN, the IP addresses could be assigned starting with 192.168.1.*x*, where *x* represents a number in the range of 2 to 254. In IPP address could be compared with a telephone number.

5.2 Subnet Masks

Each host in a LAN has a subnet mask. The *subnet mask* is a set of octets that is used to determine which LAN or class it belongs to. The number 255 is usually used to represent the network address portion of the IP address and a zero is placed at the end to identify the host portion of the address. Basically the subnet mask tells the devices how the network addresses are organized, and helps to determine which addresses are local and which are remote (on the other side of the router).

5.3 Gateway Address

Addressees are either local or remote. A *gateway address* is composed of four octets separated by decimal points. The gateway address is used to uniquely identify the device on the LAN that has access to the communications links connecting to other LANs, WANs and/or the Internet (access to the 'remote' addresses).

5.4 Virtual Ports

A **port number** represents a "channel" or entryway for network communications. Port numbers allow different computers to utilize network resources without interfering with each other. Port numbers most commonly appear in network programming, particularly socket programming. Sometimes, though, port numbers are made visible to the casual user. For example, some websites on the Internet use a URL like the following:

`http://www.sitename.com:8100/`

In this example, the number 8100 refers to the port number used by the browser to connect to the web server. The standard port number used by web sites is 80, so this number does not need to be included with the URL (although it can be). In IP networking, port numbers can theoretically range from 0 to 65535. Most popular network applications, though, use port numbers at the lower end of the range (such as 80 for HTTP). Ports are similar to doors and windows of your house, with port 80 acting as the front door. If these are not open you could not enter the house. This is the same case with ports on a network. If the ports for a specific IP address are not open then you could not gain access to that IP address.

Note: *The term port also refers to several other aspects of network technology. A port can refer to Ethernet connection points, such as those on a hub, switch, or router. The term port is also used to refer to a physical connection point for peripheral devices such as serial, parallel, and USB ports.*

Another analogy would be: if a WAN IP address is similar to the phone number identify a site, IP ports are similar to telephone extensions, in that they allow communication with specific devices within a site that all share the same external (WAN) IP address. A router is a device which allows multiple computers and other IP enabled equipment to share that single WAN IP address. It functions like a "switchboard operator" – opening ports creates an association between those port numbers and the LAN IP address of specific equipment on the LAN behind the router. When the router sees a 'call' for a specific 'extension' (port), it directs that data stream to the (LAN IP address of the) equipment associated with that 'extension' (port).

5.5 Pre-Installation

Before beginning the installation, please answer the following questions:

Do you have Hi-speed Internet? _____

There are many types of high speed Internet available. The most common ones are T1, Cable, and DSL (in order of speed). The DVR is not compatible with a dial-up connection.

- **Note:** *EverFocus suggests having a minimum upload speed of 256KBps. This can be addressed by your Internet Service Provider.*

What type of modem/router do you have? _____
Modem/router model name/ #

The modem/router was either installed by your Internet service provider or purchased by you to establish a connection to the Internet. A router assigns different internal IP addresses to local computers; this allows multiple computers to access the Internet through the same external IP address.

Do you have a static IP address? _____

A Static IP address means you use the same IP address every time you connect to the Internet. With a static IP address, other Internet users always know the address of your location and can easily connect with it. This makes it much simpler to host a website, email server, or other type of server connection. Everfocus suggests using a static IP address. If this is not available, you will need to use a dynamic IP address. This is explained below.

Do you have a dynamic IP address? _____

A Dynamic IP address means your IP address changes each time you connect to the Internet. We recommend asking your Internet service provider for a Static IP address. If this is not a possibility, you may use the DDNS feature of the DVR. DDNS stands for Dynamic Domain Name Server, a service that provides a central database where IP information can be stored and retrieved. It allows those using a dynamic IP address to be registered centrally so users can connect to it by name. See Chapter 7 for details on using EverFocus DDNS.

What type of DVR are you installing? _____

The default ports are

ECOR264: 80

Paragon: 80

ECOR: 80, 1600

EDR/EDVR: 80, 1600, and 37260 – 37263

EMV: 80

If the ports were changed in the Network Setup, use those port numbers.

5.6 What is your Network Setup?

Everfocus DVR's can operate using one of three types of networking connections.

1. **Simple One to One Connection:** A simple one to one connection is the simplest type of network connection. It uses a cross-over cable to make a direct connection from one computer to another (or in this case a computer to a DVR).

2. Direct High Speed Modem Connection: A direct modem connection uses a standard network cable to connect the modem directly to a computer (or in this case a modem to the DVR). This type of connection only covers single-port modems. For a combination modem/router, use the setup described below.
3. Router or LAN Connection – A local area network connection requires either a router or a pre-existing LAN connection. This is the most common type of connection. A router allows multiple computers and DVR's to access each other as well as the Internet. It assigns different internal IP addresses to the computers.

5.7 Simple One to One Connection

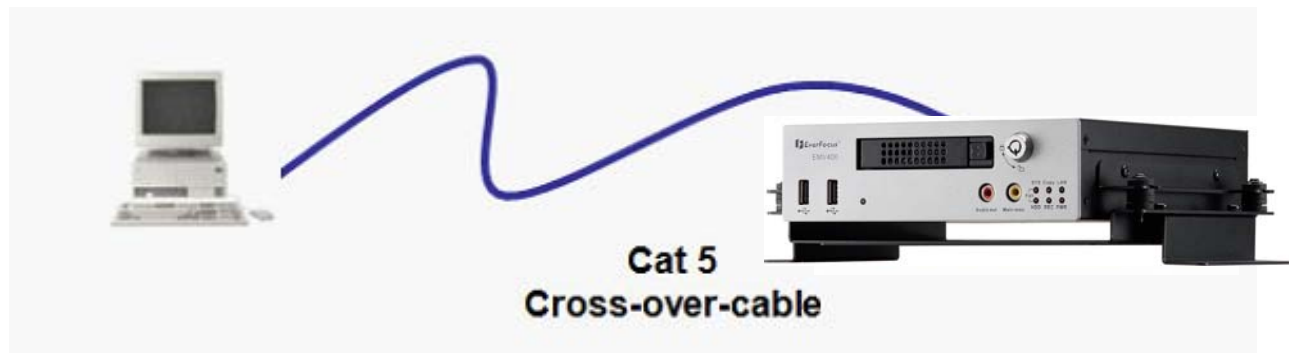

Crossover Ethernet Cable Pin outs:

The Figure below shows the pin configurations for a cross-over cable.

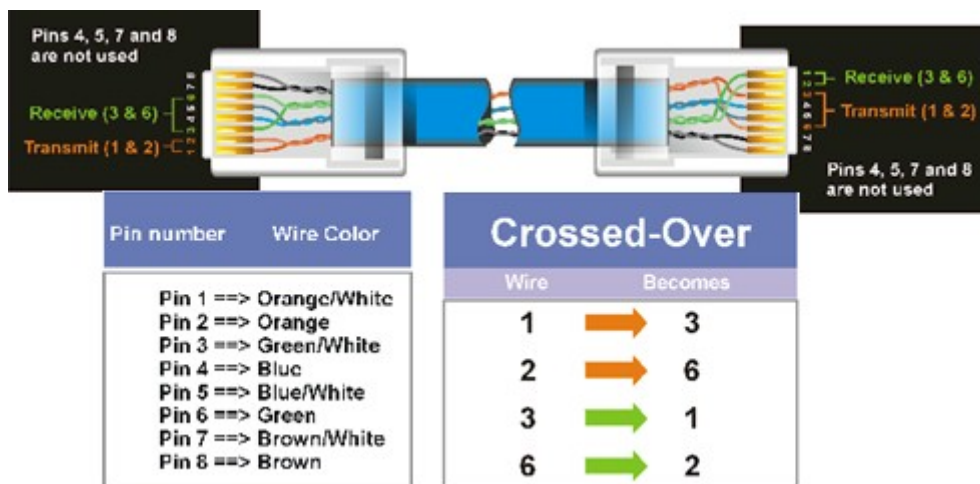

Connection Procedure:

- The First step is to purchase or make a cross-over cable. We recommend purchasing one if you have never made a cross-over cable. Please remember you can not use a straight through network cable for this application
- Once you have a cross-over cable plug one end into the LAN port on the back of the DVR and the other into the network card on the back of the computer.
- Log into the EverFocus DVR menu and go to the Network Setting Menu.
- You must use the Static IP option for this type of connection.
- Assign an IP of 192.168.001.003, a Subnet Mask of 255.255.255.000, and a Gateway of 192.168.001.001. You can ignore DNS Server.
- The next step is to set the computer's network settings to match those of the DVR. You will need Administrator privileges on your Windows machine to do this.
- To assign a fixed IP address in Windows 2000/XP.

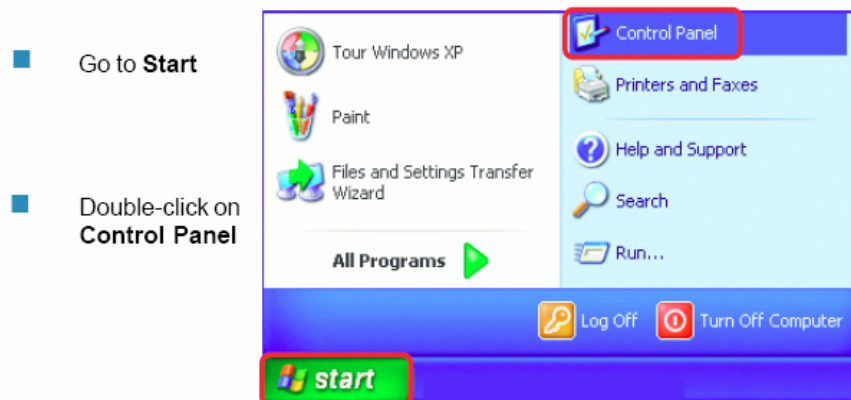

- Double-click on **Network Connections**

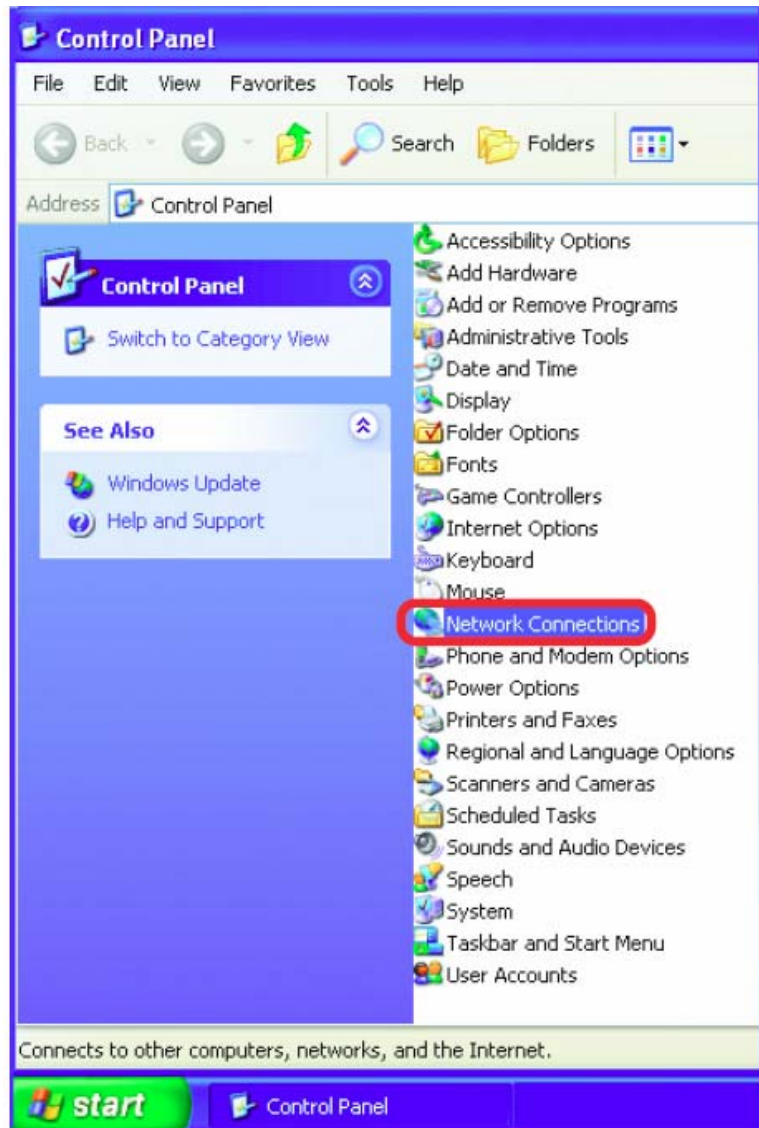

- Right-click on **Local Area Connections**

- Double-click on **Properties**

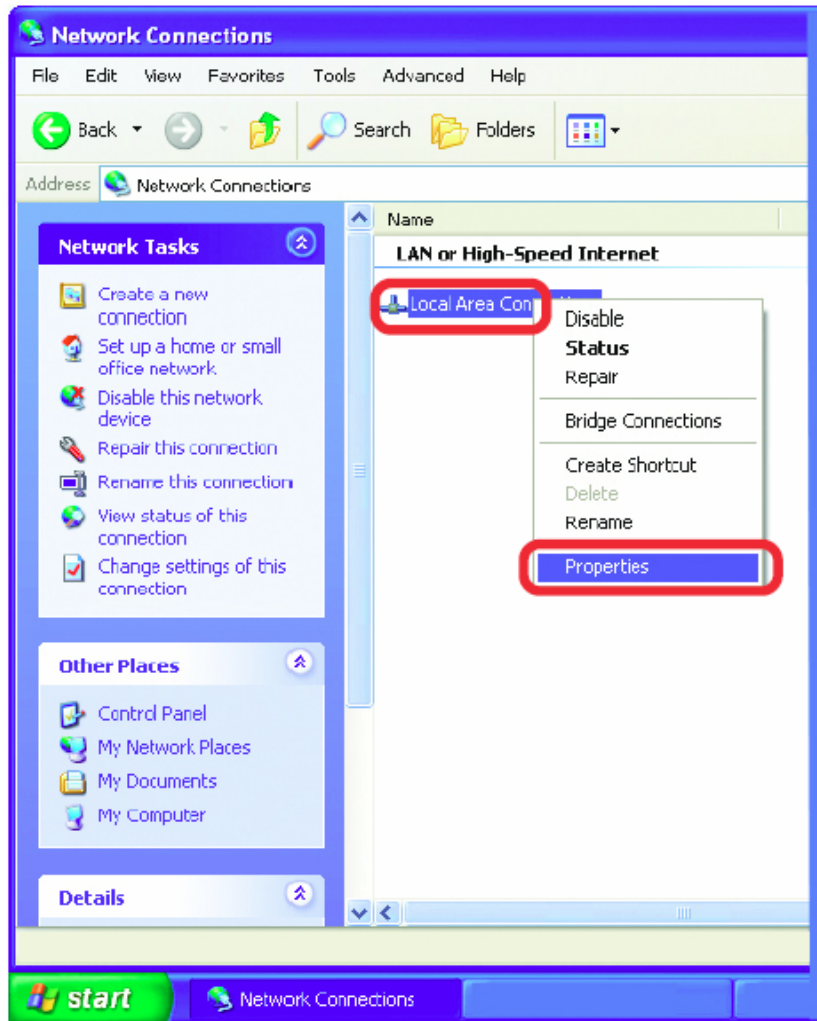

- Click on **Internet Protocol (TCP/IP)**
- Click **Properties**

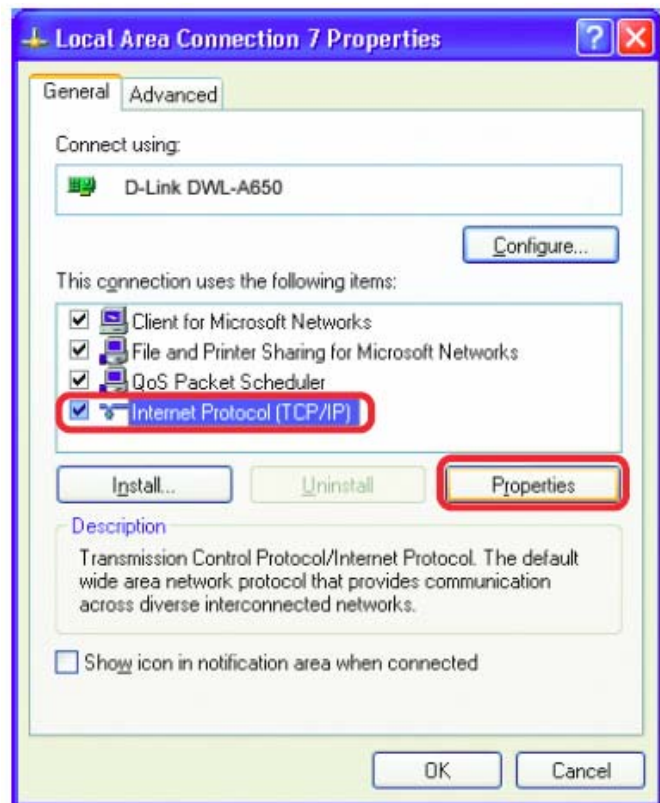

- Click on the option that says "Use the following IP address"
- Assign an IP address of 192.168.1.2, a Subnet Mask of 255.255.255.0, and a Default Gateway of 192.168.1.1, then click OK.
- Restart both the computer and the DVR.
- To access the DVR from the computer, simply open Internet Explorer and in the address bar type:

<http://192.168.1.3>

5.8 Direct High Speed Modem Connection

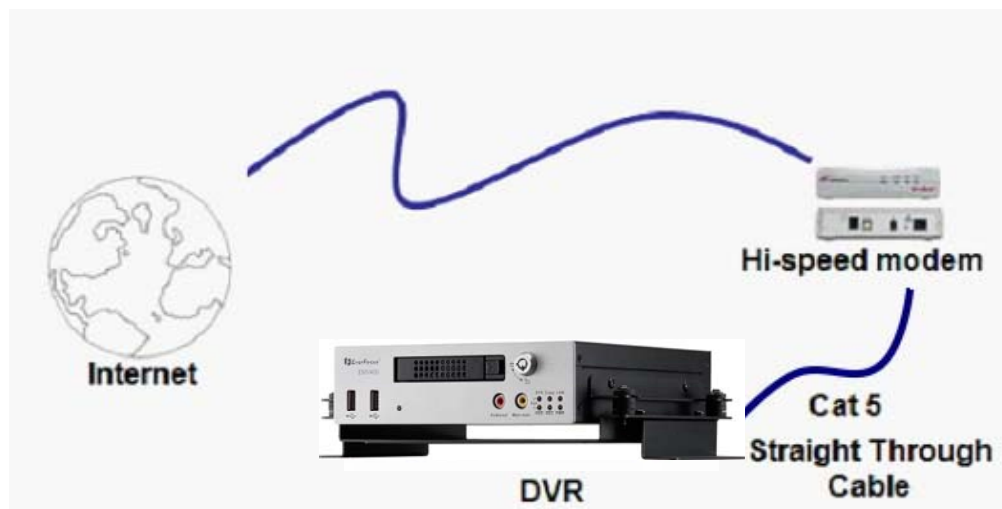

Straight Through Ethernet Cable Pin outs:

The Figure below shows the pin configurations for a straight cable.

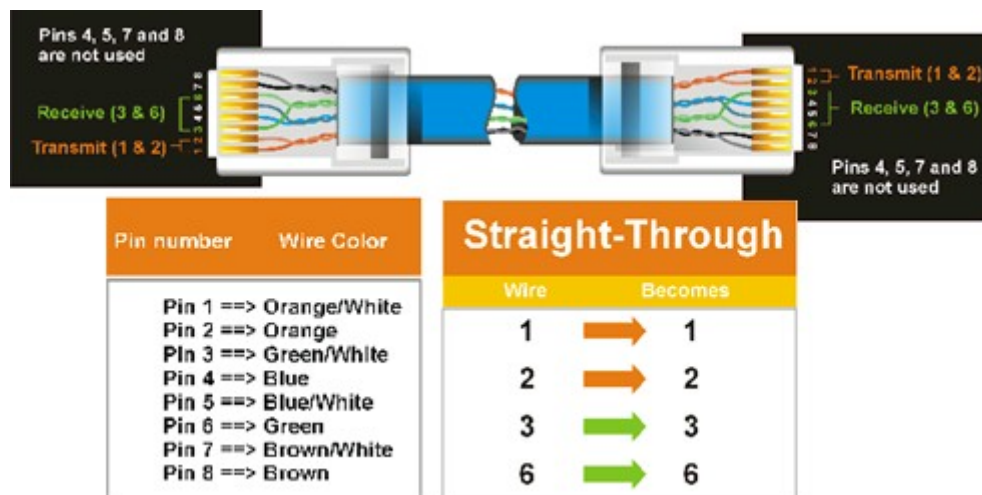

Connection Procedure:

- The first step is to purchase or make a straight through cable. We recommend purchasing one if you have never made a straight through cable. Please remember you can not use a cross-over network cable for this application
- Once you have a straight through cable plug one end into the LAN port on the back of the recorder and the other into the high speed modem.

- Log into the EverFocus DVR menu and go to the Network Setting Menu.
- Input the Static IP address, the Subnet Mask, and the Gateway that you obtained from the internet service provider.
 - **Note:** *If you have a dynamic IP address, you can set the DVR to DHCP to automatically detect the network settings. Therefore, it can use a dynamic IP address.*
- Exit from the DVR's Menu to save the settings.
- To access the DVR from a computer, open Internet Explorer and in the address bar type:
http:// (IP address given by your internet service provider)
 - **Note:** *When using this type of connection, only one device can be connected to the modem at a time. You will need to use a computer at a different location to test the connection.*

5.9 Router or LAN Connection

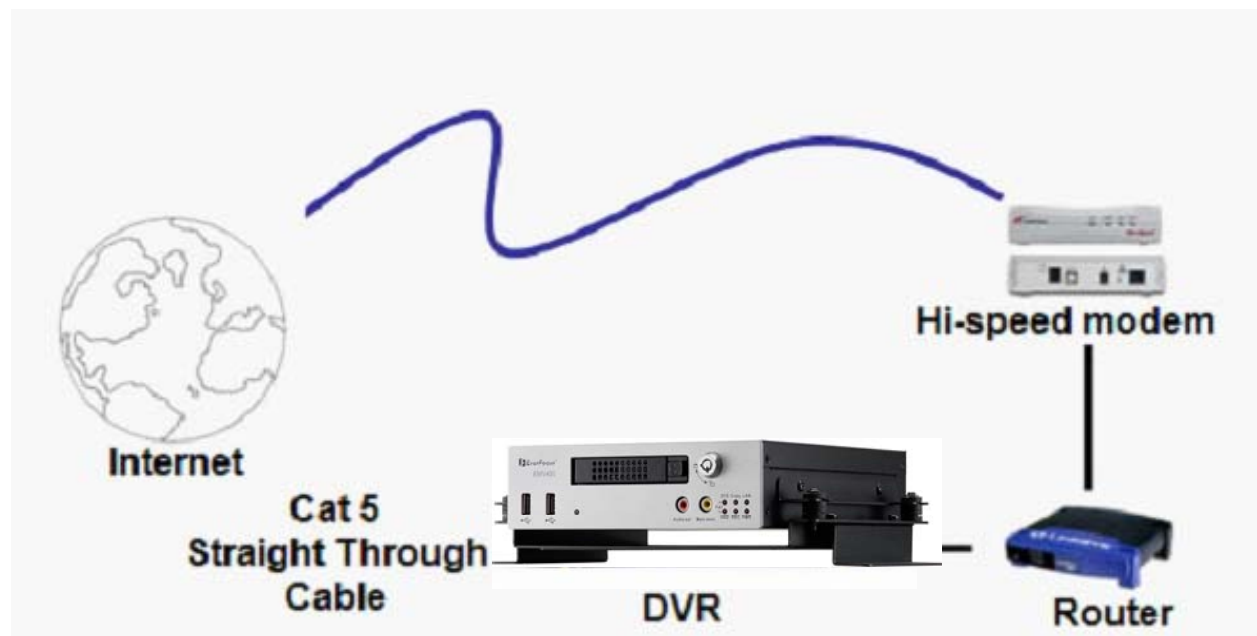

Straight Through Ethernet Cable Pin outs:

The Figure below shows the pin configurations for a straight cable.

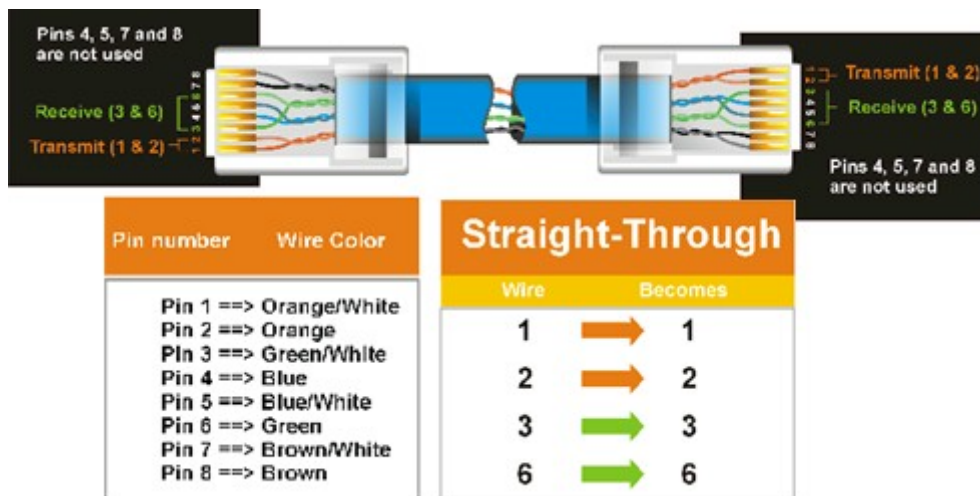

Connection Procedure:

- The First step is to purchase or make a straight through cable. We recommend purchasing one if you have never made a straight through cable. Please remember you can not use a cross-over network cable for this application

- Once you have a straight through cable plug one end into the LAN port on the back of the recorder and the other into the router.
- Log into the EverFocus DVR menu and go to the Network Setting Menu.
- To let the router automatically assign an address:
 - Set the Network Type to DHCP. Make sure to write down the IP address and the Gateway.
 - Exit from the Menu to save settings.

To manually assign an address:

- Go to a computer connected on the same network as the DVR.
- Click on the Start button and choose Run.
 - If using Windows Vista, choose Search instead.
- Type "command" and click on OK.
 - In Vista, you will need to double-click on the "Command Prompt" file to open it..
- In the DOS prompt, type "ipconfig" and press Enter.
- The network information will be displayed on a screen similar to the one below.
 - In Windows Vista, look for the information that says "IP v4".

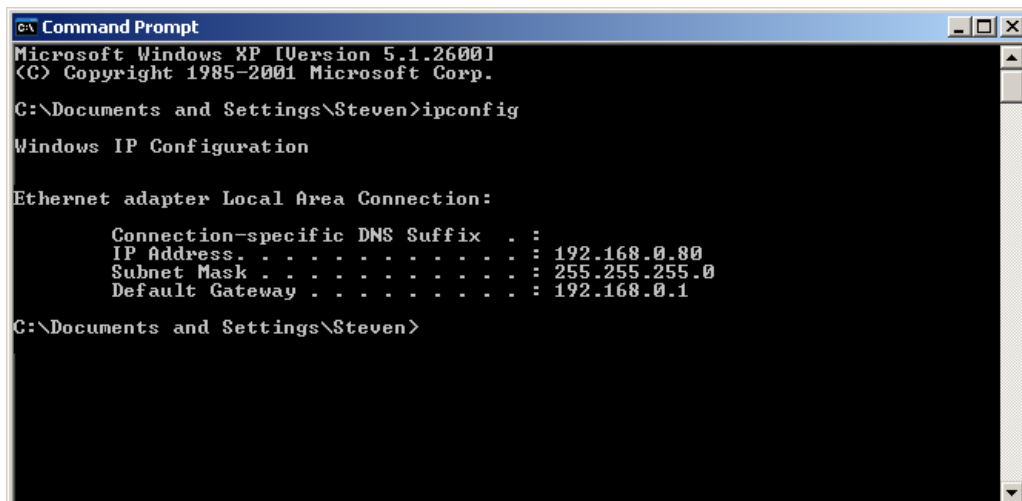

```
Microsoft Windows XP [Version 5.1.2600]
(C) Copyright 1985-2001 Microsoft Corp.

C:\Documents and Settings\Steven>ipconfig

Windows IP Configuration

Ethernet adapter Local Area Connection:

    Connection-specific DNS Suffix . :
    IP Address . . . . . : 192.168.0.80
    Subnet Mask . . . . . : 255.255.255.0
    Default Gateway . . . . . : 192.168.0.1

C:\Documents and Settings\Steven>
```

- Take the values for Subnet Mask and Default Gateway and input them into the DVR; these values should be exactly the same in both devices. However, you should change the last

number of the IP address. For example, if the IP address of the computer is 192.168.2.101, the DVR's IP address should be 192.168.002.050.

- To access the DVR from a computer simply open Internet Explorer and in the address bar type:
http:// (IP address of the DVR)
 - **Note:** *The DVR's IP address will only work at the location of the DVR. To connect from a different location over the Internet, see below.*

To set DVR for Internet Connection through router

- The next step is to open ports within your router. Log into the router using a PC and open the following ports.
 - Ports to open: 80
 - If your Internet service provider blocks port 80, you can change it to a different port in the DVR's Network Menu Setup; open/forward that port instead.
 - If you are using a Linksys or D-Link router, see Chapter 8 for basic support on setting up ports. For any other router, you will need to contact the manufacturer for support.
- To access the DVR from a computer simply open Internet Explorer and in the address bar type:
http:// (the IP address given by your internet service provider)
 - **Note:** *If you changed to a different port other than 80, you will need to include this at the end of the IP address*

http:// (the IP address given by your internet service provider): portnumber
- If you have a WAN Dynamic IP address and have opened the ports, go to Chapter 7 to setup DDNS.

6 REMOTE OPERATION FROM BROWSER

6.1 CONNECTING TO EMV400

To access the DVR from a computer, open an Internet Explorer window and in the address bar type:

Local connection: http:// (IP address from the DVR's Network Menu): IP port used
e.g. http://192.168.1.163:2468

Internet connection: http:// (IP address given by your Internet Service Provider): IP port used
e.g. http://57.182.67.204:2468

You should then see a login prompt.

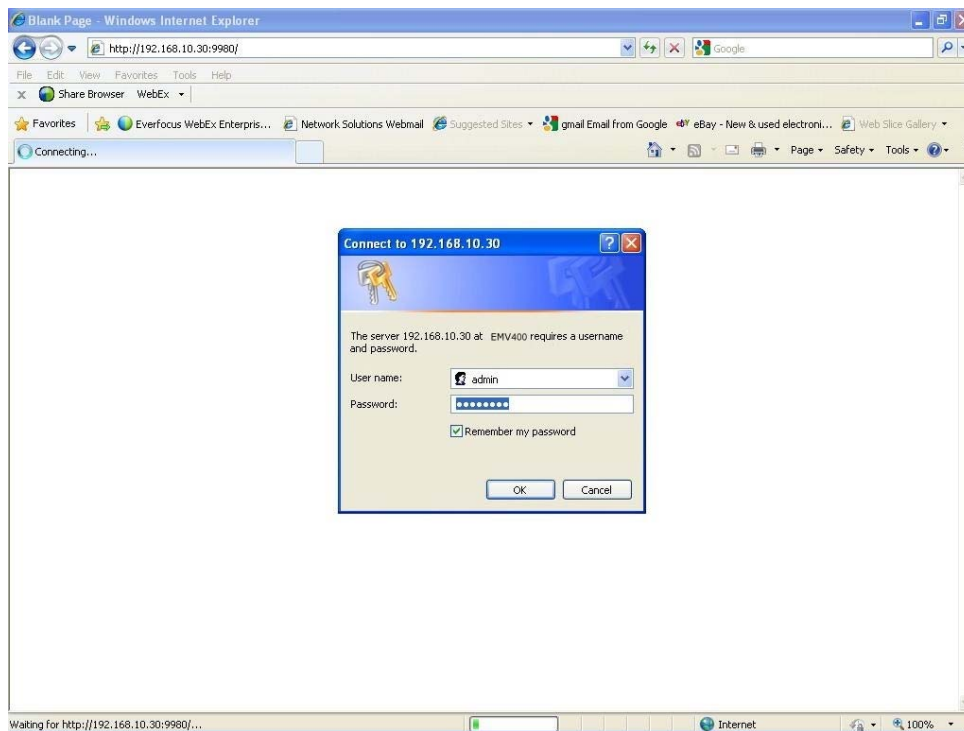

- The login page will appear on the screen similar to the one shown above.

- Enter a user name and password to access the recorder. These can be changed in the System section of the Main Menu.
- The default user name is "admin". The default password is "11111111".
- Click on the Login button and you will log in to the recorder's Network Viewer.

6.2 BROWSER SECURITY SETTING

6.2.1 Installing ActiveX controls

When you first connect to the DVR's IP address, you should see a screen like the one below. If you do not see a yellow bar like the one the arrow is pointing at, your security settings may be too high. If so, go to "Section 6.2.2 - Enabling ActiveX Controls."

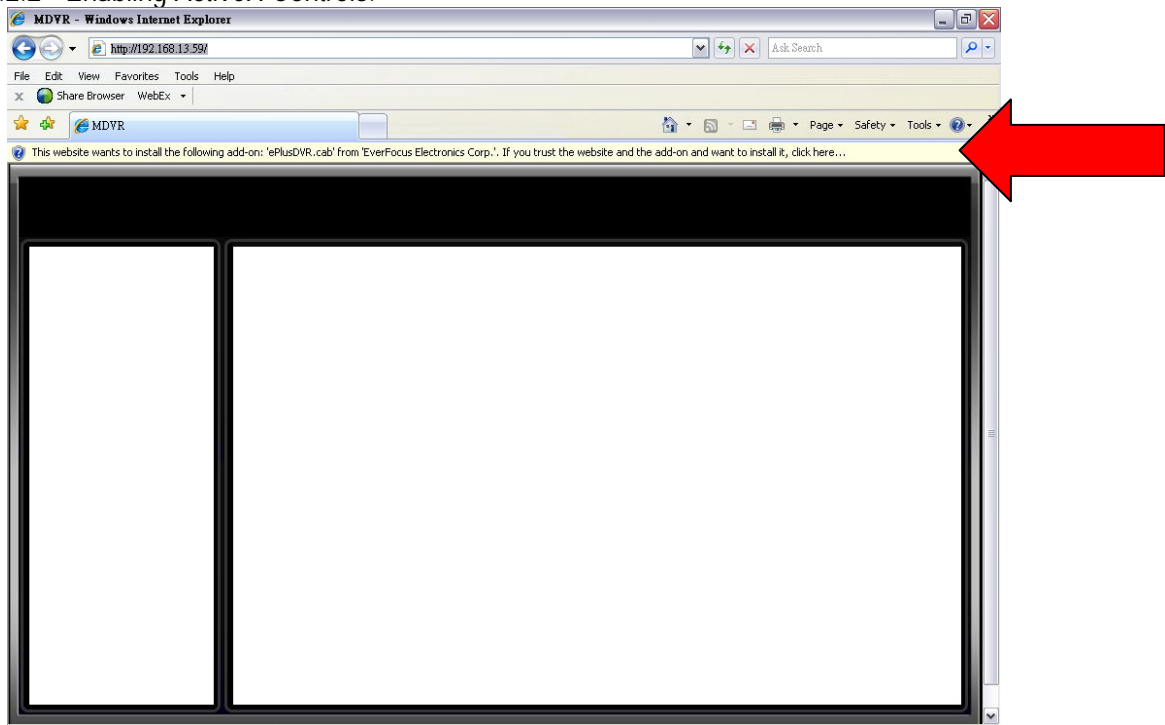

Right click on the yellow bar and select "Install This Add-on..."



Install the ePlusDVR.cab file when prompted to do so.



Once the file finishes installing, you will return to the screen like the one below.

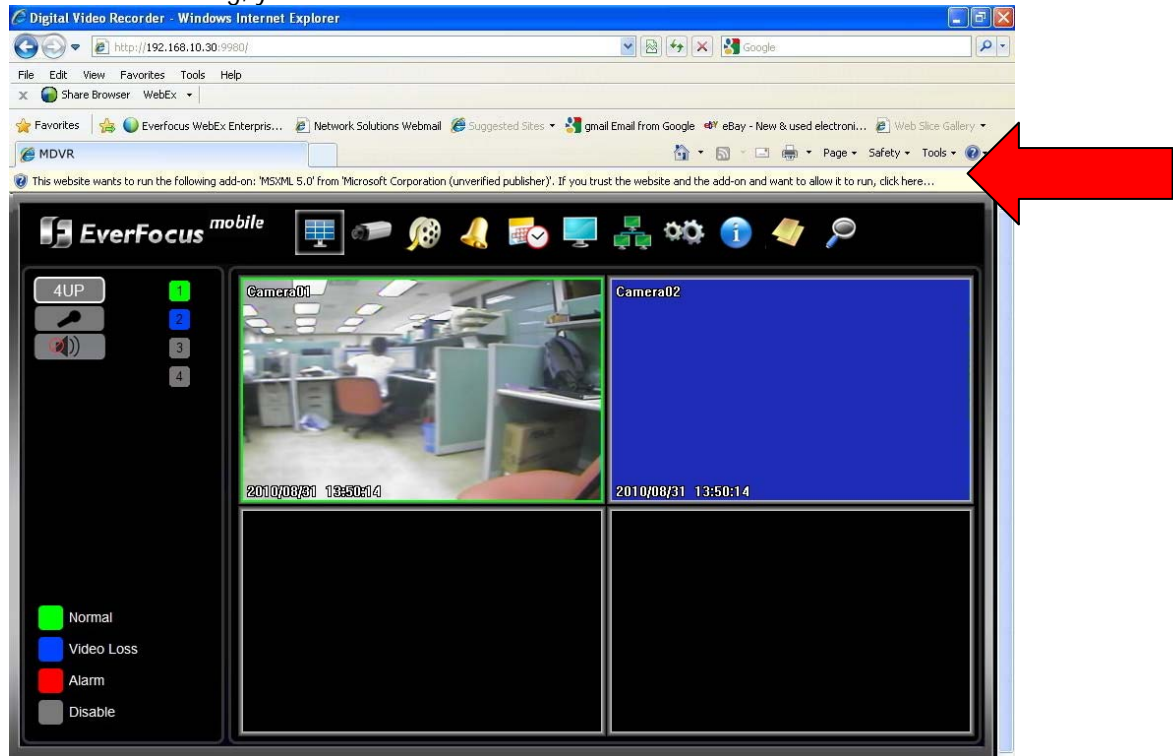

Right click on the yellow bar and select "Run Add-on..."

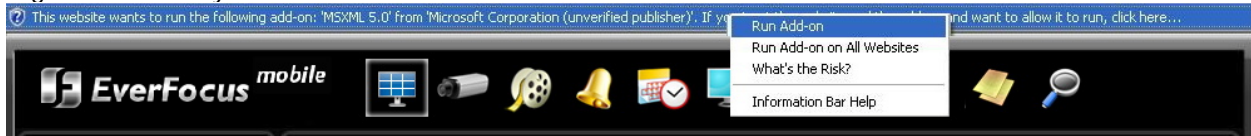

Install the MSXML file when prompted to do so.



Now, you will be able to see the remote live page.

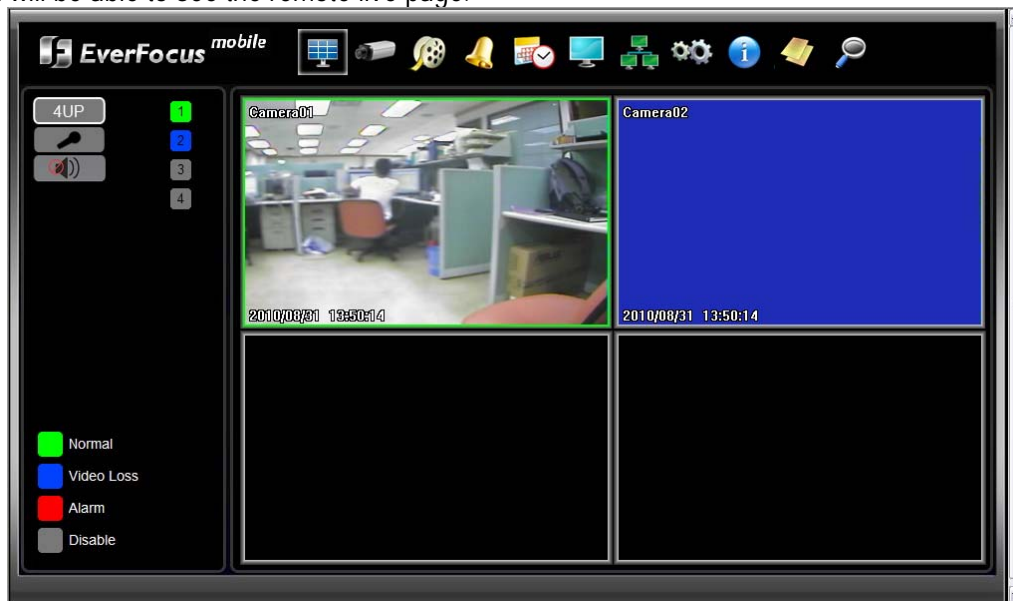

6.2.2 Enabling ActiveX Controls

Note: This section is only necessary if you DO NOT see the yellow ActiveX bar at the top of your browser screen when you first connect to the DVR.

At the top of the Internet Explorer Window, click on Tools, then select Internet Options.



Click the Security tab at the top of the window, then choose Custom Level near the bottom.

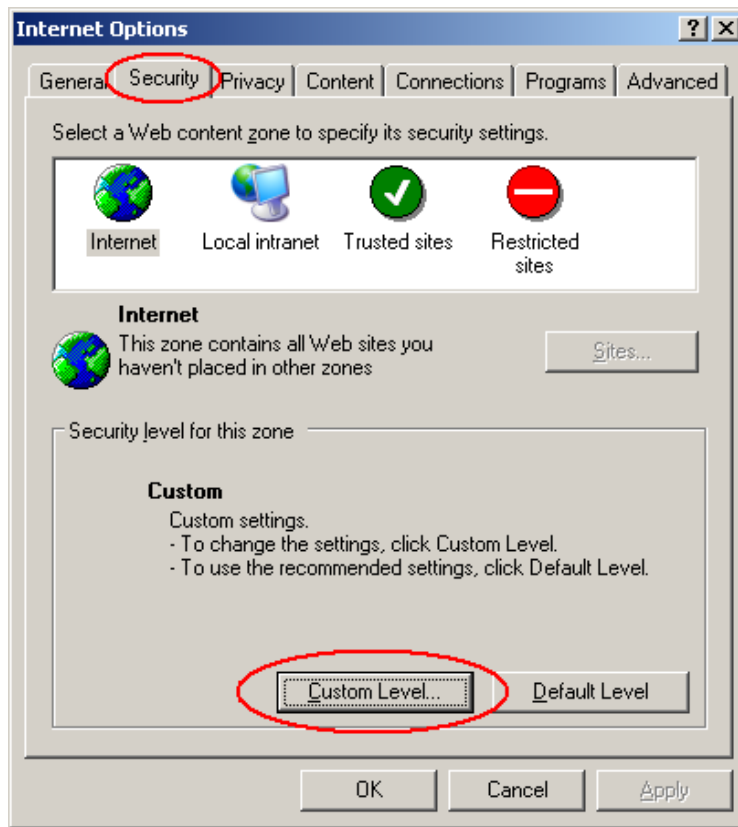

In the Security Settings window, scroll to “ActiveX controls and plug-ins”

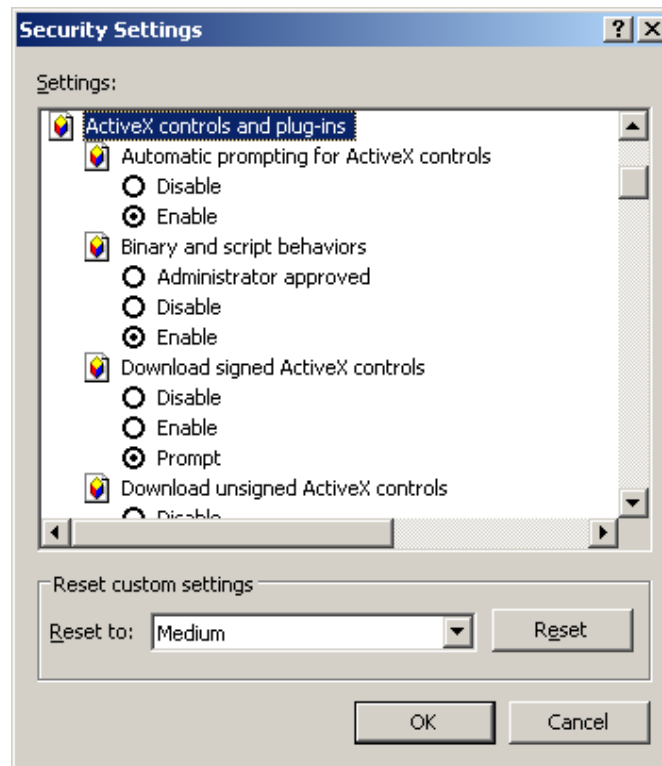

Set the controls as follows:

“Enable”:

- ✓ Allow previously unused ActiveX controls to run without prompt (*Internet Explorer 7 only*)
- ✓ Allow scriptlets (*IE7 only*)
- ✓ Automatic prompting for ActiveX controls
- ✓ Binary and script behaviors
- ✓ Display video and animation on a webpage that does not use external media player (*IE7 only*)
- ✓ Run ActiveX controls and plug-ins
- ✓ Script ActiveX controls marked safe for scripting

“Prompt”:

- ✓ Download signed ActiveX controls
- ✓ Download unsigned ActiveX controls

“Disable”:

- ✓ Initialize and script ActiveX controls not marked as safe

Click OK and then choose Yes to change the security settings.

Close the window so you are back at the login screen.
Click the Refresh button to reload the page.



Install the ePlusDVR.cab file when prompted to do so.

Once the file finishes installing, you will return to the same login page as before.
Type in the user name and password and click Login to view the cameras.
Default user name: admin
Default password: 11111111.



6.3 REMOTE LIVE VIEW

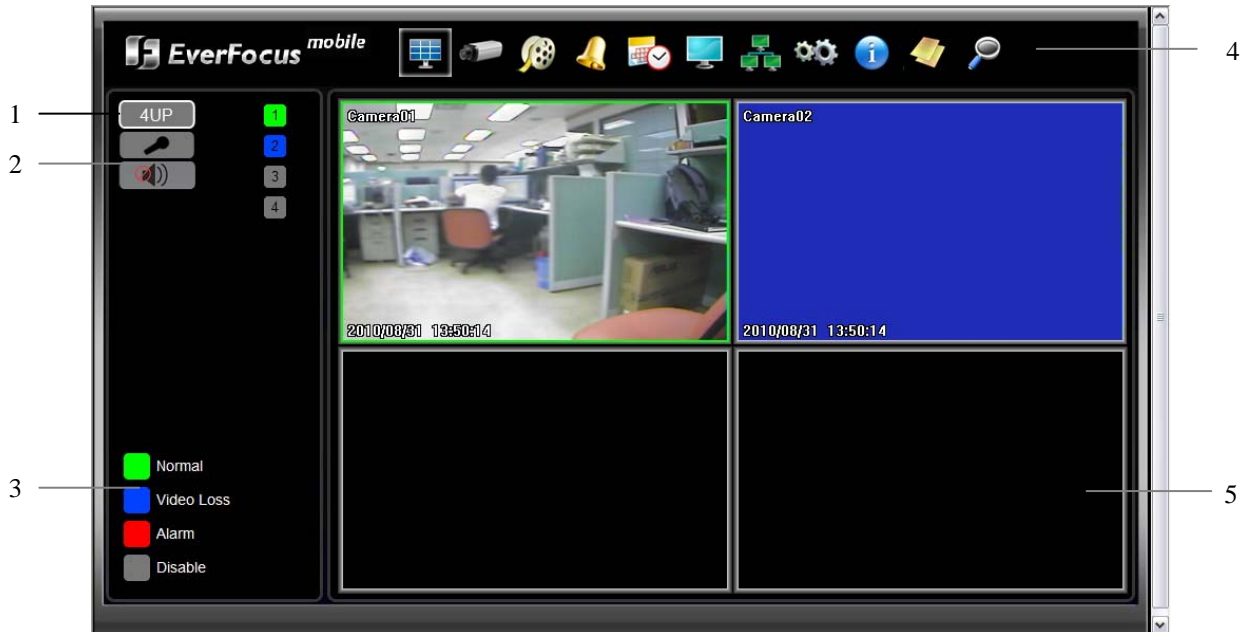

1. Click on a camera number on the left side of the display to switch that camera to full screen. Click on "4UP" to display 4 screens.
2. You can click the "Mic" button to transfer audio to DVR from client side if there is a microphone attached to the PC and an amplifier and speaker attached to the DVR. You can also click the "Speaker" button to transfer audio to the client side from DVR if there is a speaker on the PC and a microphone and preamp attached to the DVR, and audio recording is enabled on the DVR. Double click on a camera image to enlarge the current display to full screen; double click again to return to the normal view.
3. The status of each camera is represented by different colors on the left side of the screen. Green means normal; orange indicates a Motion alarm; blue indicates Video Loss, red indicates an alarm event and grey means disable
4. **Menu bar:** Menu buttons for setup, search and export, details are explained in following chapters.



Live View



Camera Setup



Record & Play Setup



Alarm/Event Setup



Date/Time Setup



Display Setup



Network Setup



System Setup



Information Setup

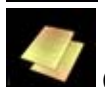

Copy Menu



Search Menu

5. In the main page, you will see live images in a 4-screen display.

6.4 REMOTE PLAYBACK

To playback the video, click the "Search" button. Select from "Time Search", "G Sensor Search", "GPS Search" or "Event Search". For more details about Search setting, please refer to "3.4 Search Setting".

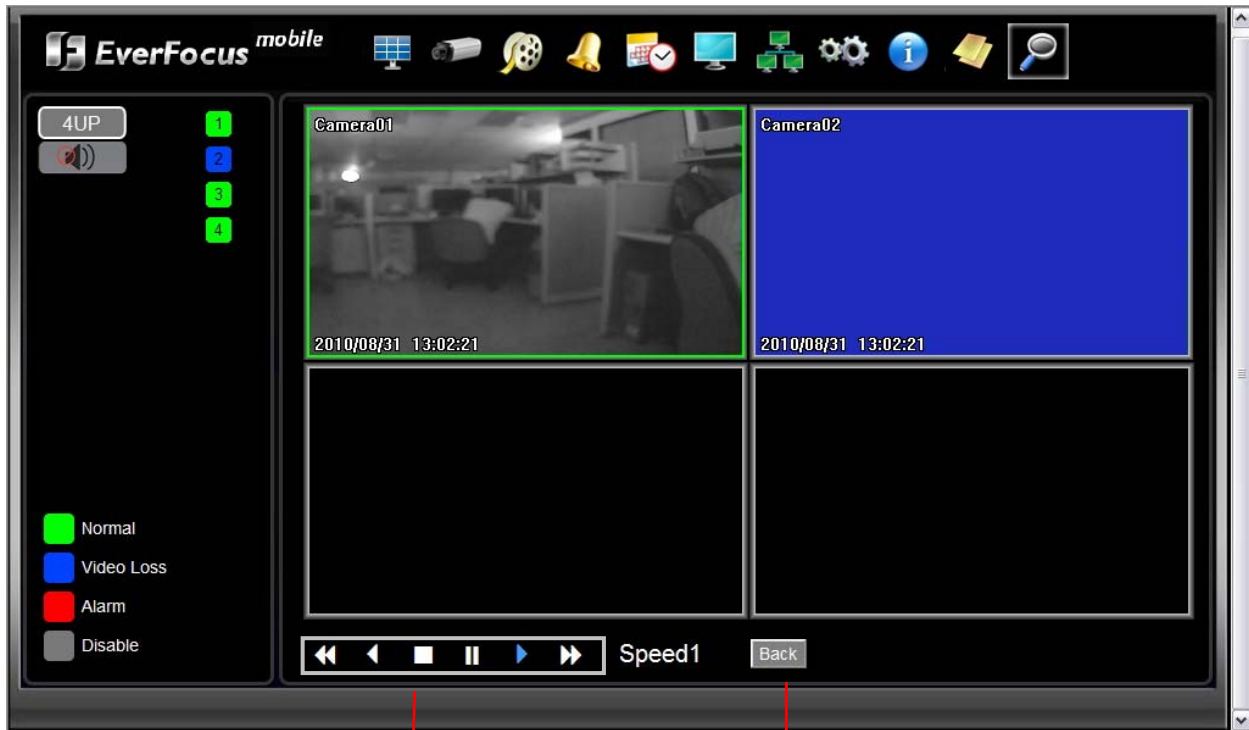

Playback Control Keys

Back: returns to live view

Playback Control Keys:

1.  Fast rewind the video.
2.  Play Reverse the video.
3.  Stop playback.
4.  Pause
5.  Playback the video.
6.  Fast forward the video.

7 EVERFOCUS DDNS SETUP

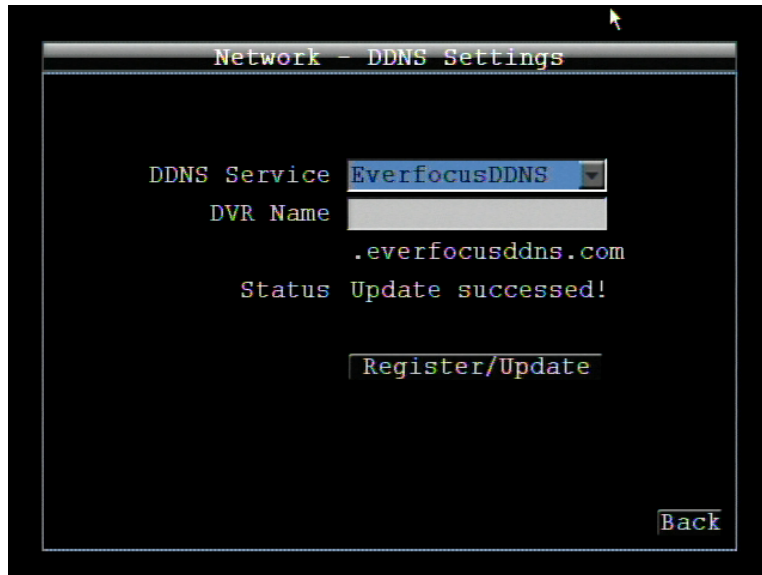

Setup Steps:

Step 1. Set up the Network Menu according to the instructions detailed in the Networking chapter. (Make sure that DNS Server 1 is set correctly or DDNS will not work)

Step 2. Go to the website <http://everfocusddns.com> and check for an available name.

Note: This step is optional, though recommended, as it is used to check the availability of a host name. If the name is already used, and attempt to register that name must fail. If the name is available, proceed to step 3 for DDNS setup.

Step 3. In DVR's Network Menu, go to DDNS. Choose "EverfocusDDNS" for the Server and put in your chosen name in the field: DVR Name.

PLEASE NOTE: The name of the DVR cannot include a space, or a dot (period) or any special characters particularly ~ ! @ # \$ % ^ & * () + < > " ; : , , _

Step 4. Click (or select and press Enter) on the "Register/Update" button to synchronize the DVR with the DDNS server. You should see an indication of "Success" on the screen. If you see "Could Not Find Server" or any other error message instead, double-check your network settings and DDNS name and resubmit the DDNS name until you get "Success".

Step 5. You should now be able to connect by typing the name you created into the address bar.
Example: <http://hostname.everfocusddns.com>

It is not necessary to append the HTTP port number to the DDNS name. The EverFocus DDNS server not only keeps track of your DVR's IP address, it keeps track of the ports too!

8 LINKSYS & D-LINK PORT FORWARDING

8.1 TYPICAL LINKSYS PORT FORWARDING

This section will cover a few simple configurations for the Linksys router. This chapter is only to offer some help to the installer and end user. Please understand we **DO NOT** support this product and will not give tech support on it. If you need additional technical support on this router you must call Linksys.

To access the Web-based Utility, launch a web browser and type the Router's IP address, typically **192.168.1.1**, in the address bar. Then press **Enter**. A password request page will appear. (Non-Windows XP users will see a similar screen.) Leave the *User Name* field blank. The first time you access the router, use the default password **admin**. Click the **OK** button to continue.



The first screen that appears displays the Setup tab. This allows you to change the Router's general settings. Change these settings as described here and click the **Save Settings** button to apply your changes or **Cancel Changes** to cancel your changes.

Click on the "Applications & Gaming" tab.

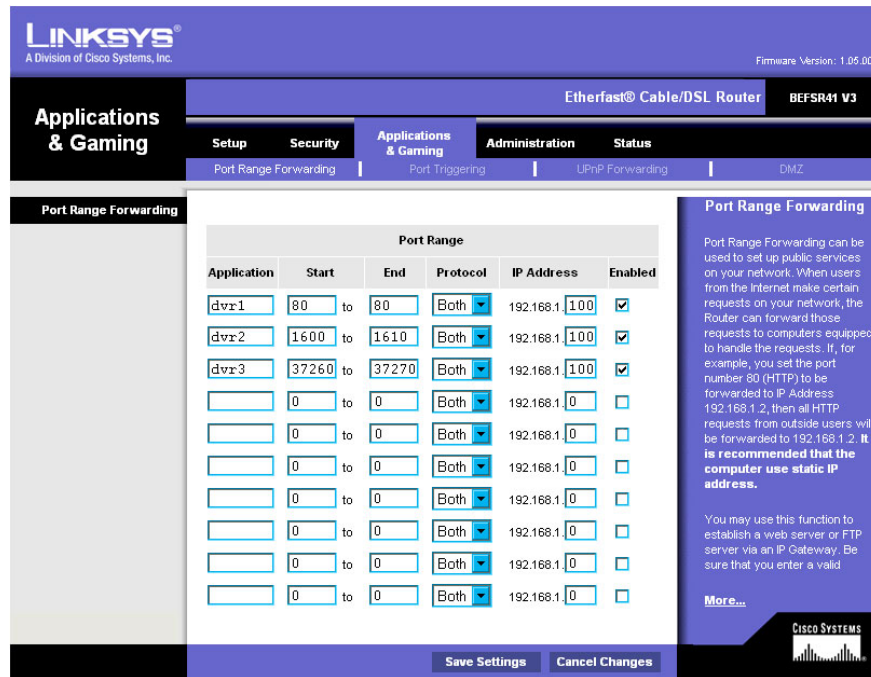

Applications and Gaming allows you to set up public services on your network, such as web servers, ftp servers, e-mail servers, or other specialized Internet applications. (Some Internet applications may not require any forwarding) To forward a port, enter the information on each line for the criteria required. Descriptions of each criterion are described here.

Application - In this field, enter the name you wish to give the application.

Start/End - Enter the starting number of the range under **Start** and the ending number under **End**.

Protocol - Enter the protocol used for this application, either **TCP** or **UDP**, or **Both**.

IP Address - For each application, enter the IP Address of the PC running the specific application.

Enable - Click the **Enable** checkbox to enable port forwarding for the relevant application.

When finished making changes, click the **Save Settings** button to apply your changes or **Cancel Changes** to cancel them.

Here is an example for how the port information might look:

HTTP 80 to 80 Both 192.168.1.50 Enable

Where 192.168.1.50 is the IP address of the EMV400 on the LAN, and the default port 80 is in use.

Note: *If you changed port 80 in the DVR's Network Menu, open that port instead of 80.*

8.2 TYPICAL D-LINK PORT FORWARDING

This section will cover a few simple configurations for the D-Link router. This chapter is only to offer some help to the installer and end user. Please understand we **DO NOT** support this product and will not give tech support on it. If you need additional technical support on this router you must call D-Link.

Whenever you want to configure your network or the DI-624, you can access the Configuration Menu by opening a web-browser and typing in the IP Address of the DI-264.

The DI-264 default IP Address is 192.168.0.1.

- Type "admin" in the **User Name** field
- Leave the **Password** blank
- Click **OK**

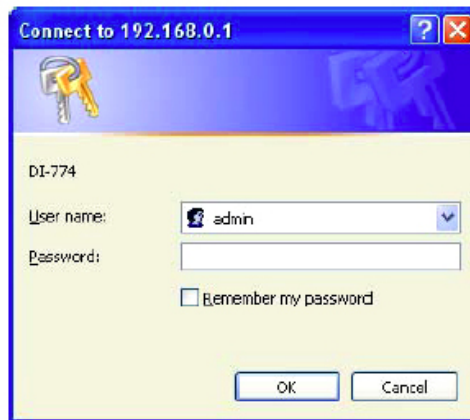

The first screen that shows up is the Home Tab. This is the starting point for all the router's settings and functions.

Click Virtual Servers on the left to bring up the following screen.



Virtual Servers allows users who are connecting remotely to access services on the router's Local Network. The functions of each field are described below.

Virtual Server - Select **Enabled** or **Disabled**

Name - Enter the name referencing the virtual service

Private IP - The IP address of the device running the local services.

Protocol Type - The protocol used for the virtual service.

Private Port - The port number that the service uses on the LAN (Local Area Network).

Public Port - The port number that the services uses on the WAN (Wide Area Network).

Schedule - The time period the virtual server will be active.

When you have input all the information for a virtual server, click on **Apply** to add it to the list at the bottom or **Cancel** to clear all fields.

Here is an example of the information for each service:

<u>Name</u>	<u>Private IP</u>	<u>Protocol</u>	<u>Private Port</u>	<u>Public Port</u>	<u>Schedule</u>
HTTP	192.168.1.50	Both	80	80	Enable

Where 192.168.1.50 is the IP address of the EMV400 on the LAN, and the default port 80 is in use.

Note: *If you changed port 80 in the DVR's Network Menu, open that port instead of 80.*

9 TROUBLESHOOTING

If you have problems with the system, run through the following checklist to see if you can solve the problem.

- **The DVR will not go into record mode.**
 - Bring up the DVR's Menu and check under the Camera Menu. Verify that all connected cameras are checked as "Installed" and that Record Mode is set to "Continuous".
 - Check the Disk or Information Menus and verify that the internal hard drive is being detected.

- **The DVR displays nothing on the main monitor.**
 - Make sure the monitor is connected to either BNC Main Monitor port or the VGA port. If the monitor has multiple inputs, make sure it is on the correct input source and display setting (1024x768).
 - Check that the monitor cables are good and power is on.
 - Verify the recorder is getting the correct supply power.

- **There is no display coming from one of the channels on the DVR.**
 - In the DVR's Camera Menu, make sure that all cameras are checked as "Installed" and unchecked for "Covert".
 - If there is still no picture, switch ports or connect a working camera to the port that has no picture. If you get an image, the problem is coming from the camera or cable.

- **I cannot connect to the recorder via the internet.**
 - Check that you can connect to the DVR on the LAN.
 - Check that the DVR has a static IP address and the port used by the DVR is forwarded correctly to that IP address in the router.
 - Verify that your Internet Service Provider does not block the IP port being used

- Make sure you are using the correct WAN IP address given by the ISP, or, if you have a Dynamic IP, check if the IP address has changed; use DDNS to avoid problems caused by changing ISP addresses.

APPENDIX A: TIMING OF ALARM MODES

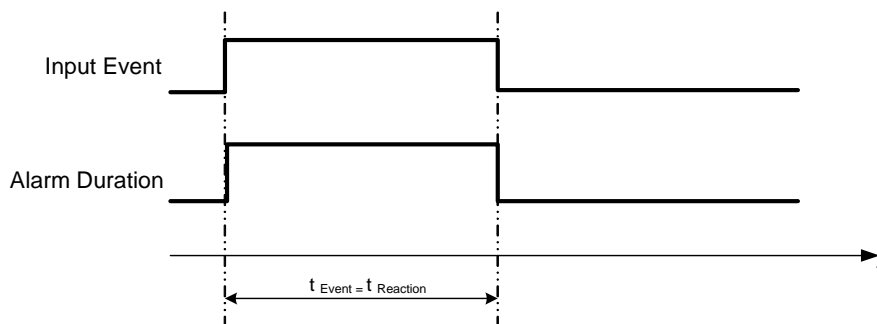
Transparent Mode

t_{Event} : Duration of alarm input source (motion, contact, system events...)

t_{reaction} : Resulting duration for this alarm mode, related to event record, alarm outputs, OSD message, buzzer

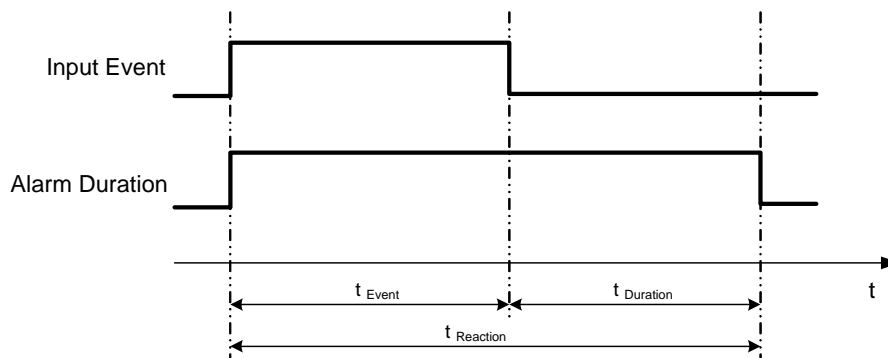
Timeout + Transparent Mode

t_{Event} : Duration of alarm input source (motion, contact, system events...)

t_{Duration} : Alarm duration for timeout, defined in the event setup menus

t_{reaction} : Resulting duration for this alarm mode, related to event record, alarm outputs, OSD message, buzzer

Timeout Mode

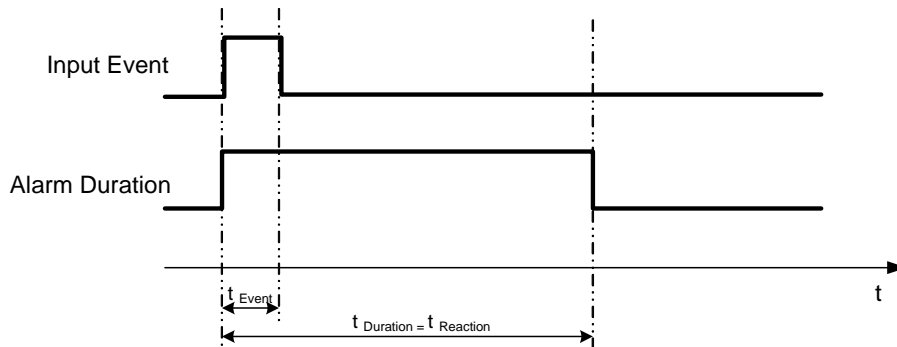

t_{Event} : Duration of alarm input source (motion, contact, system events...)

t_{Duration} : Alarm duration for timeout, defined in the event setup menus

t_{reaction} : Resulting duration for this alarm mode, related to event record, alarm outputs, OSD message, buzzer

Permanent Mode

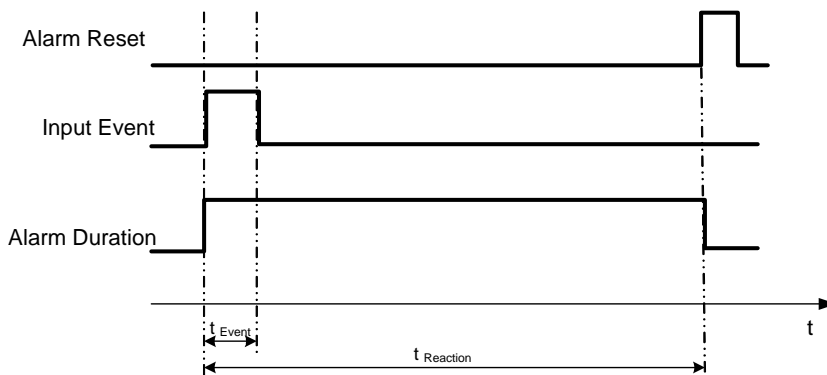

t_{Event} : Duration of alarm input source (motion, contact, system events...)

t_{Duration} : Alarm duration for timeout, defined in the event setup menus

t_{reaction} : Resulting duration for this alarm mode, related to event record, alarm outputs, OSD message, buzzer

Timeout Mode: Retrigger of Alarms

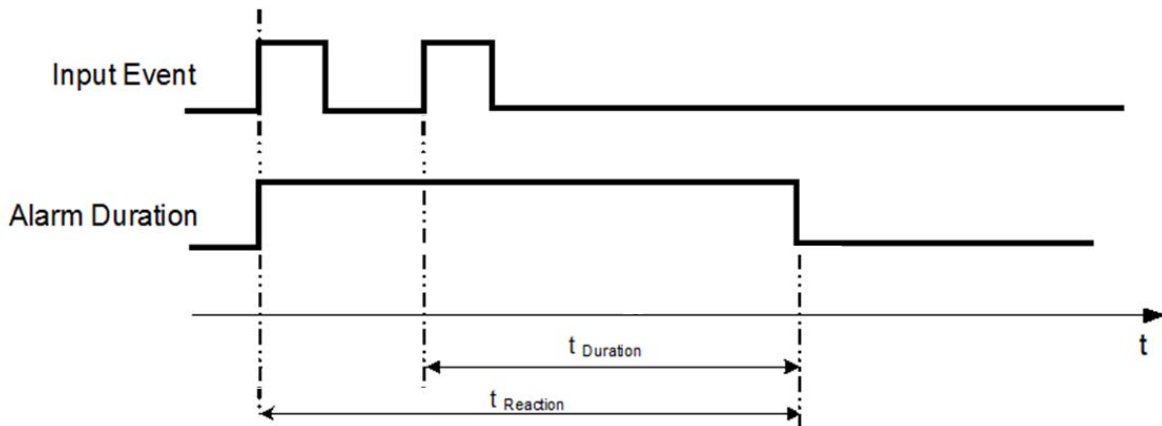

t_{Event} : Duration of alarm input source (motion, contact, system events...)

$t_{Duration}$: Alarm duration for timeout, defined in the event setup menus

$t_{reaction}$: Resulting duration for this alarm mode, related to event record, alarm outputs, OSD message, buzzer

Timeout+Transparent Mode: Retrigger of Alarms

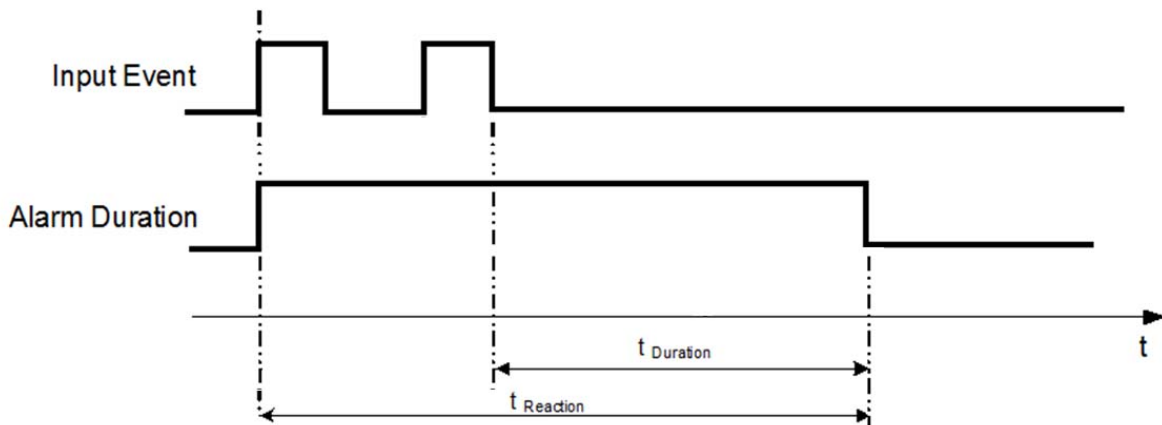

t_{Event} : Duration of alarm input source (motion, contact, system events...)

$t_{Duration}$: Alarm duration for timeout, defined in the event setup menus

$t_{reaction}$: Resulting duration for this alarm mode, related to event record, alarm outputs, OSD message, buzzer

APPENDIX B: EXPRESS SETUP RECORDING VALUE SELECTION RULES

Case 1:

Record Mode: Normal + Event

Record With: Recording days

The DVR will Auto adjust image Quality and Event frame rate to match the number of Recording days which user selected:

According to resolution, event hours and other assumptions above, the DVR will attempt to select one set of suitable quality and event frame rate by checking if set 1 meets the requirements, and proceed in order until the requirements are met. If the DVR can't match the required record days from one of the 8 sets, it will use set 8.

Checking Order	1	2	3	4	5	6	7	8
Normal Frame Rate	1	1	1	1	1	1	1	1
Quality	Superior	Standard	Low	Low	Low	Low	Low	Low
Event Frame Rate	30	30	30	15	10	7.5	5	1

Case 2:

Record Mode: Event Only

Record With: Recording days

DVR will Auto adjust Quality and Event frame rate to match the Recording days which user need:

According to resolution, event hours and other assumptions above, the DVR will attempt to select one set of suitable quality and event frame rate by checking if set 1 meets the requirements, and proceed in order until the requirements are met. If the DVR can't match the required record days from one of the 8 sets, it will use set 8.

Checking Order	1	2	3	4	5	6	7	8
Quality	Superior	Standard	Low	Low	Low	Low	Low	Low
Event Frame Rate	30	30	30	15	10	7.5	5	1

Case 3:

Record Mode: Normal + Event or Event Only

Record With: Preset Setting

DVR will apply the settings in the table below to all cameras according to the Preset Settings.

Preset Setting Option	Camera Item	Apply value
Best Quality	Quality	Superior
	Normal Frame Rate	Max recording frame rate of DVR
	Event Frame Rate	30
Standard Quality	Quality	Standard
	Normal Frame Rate	Half of max recording frame rate of DVR
	Event Frame Rate	30
Extended Quality	Quality	Basic
	Normal Frame Rate	1
	Event Frame Rate	10

APPENDIX C: REMOTE CONTROL

The IR remote control is an accessory to enhance the convenient operation of the DVR. You can perform all the settings and operations from the remote control. The effective distance is up to 33 feet line of sight. The keypad functions are same as the front panel buttons of the DVR.



ID number here must correspond to the "IR Remote ID" in "I/O Control Setup Menu". Used to select a DVR when there is more than one unit. Selecting an incorrect unit ID will prevent the DVR from responding to commands from the remote.

Channel keys #1~14

EverFocus Electronics Corp.

Headquarter Office

12F, No.79 Sec.1 Shin-Tai Wu Road,
Hsi-Chi, Taipei, Taiwan
Tel: +886-2-26982334
Fax: +886-2-26982380

Beijing office

Room 609, Technology Trade Building.
Shangdi Information Industry Base,
Haidian District, Beijing China
Tel: +86-10-62971096
Fax: +86-10-62971423

European Office

Albert-Einstein-Strasse 1,
D-46446 Emmerich, Germany
Tel: +49-2822-9394-0
Fax: +49-2822-939495

Japan Office

5F Kinshicho City Building , 2-13-4 Koto-bashi ,
Sumida-Ku , Tokyo , 130-0022 , Japan
Tel: +81-3-5625-8188
Fax: +81-3-5625-8189

USA California Office

1801 Highland Ave. Unit A
Duarte, CA 91010 ,U.S.A
Tel: +1-626-844-8888
Fax: +1-626-844-8838

USA New York Office

415 Oser Ave Unit S
Hauppauge, NY 11788
Sales: +1-631-436-5070
Fax: +1-631-436-5027

India Office

Suite 803, 8th Floor,
Housefin Bhavan,
C-21 Bandra Kurla Complex,
Bandra (East), Mumbai 400 051
Tel: +91 22 6128-8700

	<p>Your EverFocus product is designed and manufactured with high quality materials and components which can be recycled and reused. This symbol means that electrical and electronic equipment, at their end-of-life, should be disposed of separately from your household waste. Please, dispose of this equipment at your local community waste collection/recycling centre. In the European Union there are separate collection systems for used electrical and electronic product. Please, help us to conserve the environment we live in!</p>	<p>Ihr EverFocus Produkt wurde entwickelt und hergestellt mit qualitativ hochwertigen Materialien und Komponenten, die recycelt und wieder verwendet werden können. Dieses Symbol bedeutet, dass elektrische und elektronische Geräte am Ende ihrer Nutzungsdauer vom Hausmüll getrennt entsorgt werden sollen. Bitte entsorgen Sie dieses Gerät bei Ihrer örtlichen kommunalen Sammelstelle oder im Recycling Centre. Helfen Sie uns bitte, die Umwelt zu erhalten, in der wir leben!</p>
---	--	--



EverFocus[®]
P/N: 4605XEMV04002AR

Free Manuals Download Website

<http://myh66.com>

<http://usermanuals.us>

<http://www.somanuals.com>

<http://www.4manuals.cc>

<http://www.manual-lib.com>

<http://www.404manual.com>

<http://www.luxmanual.com>

<http://aubethermostatmanual.com>

Golf course search by state

<http://golfingnear.com>

Email search by domain

<http://emailbydomain.com>

Auto manuals search

<http://auto.somanuals.com>

TV manuals search

<http://tv.somanuals.com>