

# Administrator's Guide and Operating Instructions

Real Time Digital Video Recorder  
eDR1680 Series



V 1.0



### **CAUTION**

DO NOT REMOVE COVER. NO USER SERVICEABLE PARTS INSIDE.  
REFER SERVICING TO QUALIFIED SERVICE PERSONNEL.



### **WARNING**

TO REDUCE RISK OF FIRE OR ELECTRIC SHOCK,  
DO NOT EXPOSE THIS APPLIANCE TO RAIN OR MOISTURE.

#### **Safety Precautions**



- Refer all work related to the installation of this product to qualified service personnel or system installers.



- Do not block the ventilation opening or slots on the cover.



- Do not drop metallic parts through slots. This could permanently damage the appliance. Turn the power off immediately and contact qualified service personnel for service.



- Do not attempt to disassemble the appliance. To prevent electric shock, do not remove screws or covers. There are no user-serviceable parts inside. Contact qualified service personnel for maintenance. Handle the appliance with care. Do not strike or shake, as this may damage the appliance.



- Do not expose the appliance to water or moisture, nor try to operate it in wet areas. Do take immediate action if the appliance becomes wet. Turn the power off and refer servicing to qualified service personnel. Moisture may damage the appliance and also cause electric shock.



- Do not use strong or abrasive detergents when cleaning the appliance body. Use a dry cloth to clean the appliance when it is dirty. When the dirt is hard to remove, use a mild detergent and wipe gently.



- Do not overload outlets and extension cords as this may result in a risk of fire or electric shock.



- Do not operate the appliance beyond its specified temperature, humidity or power source ratings. Do not use the appliance in an extreme environment where high temperature or high humidity exists. Use the appliance at temperature within 0°C ~ +40°C and a humidity below 90%. The input power source for this appliance is AC100~240V

## Safety Precautions



The lightning flash with an arrowhead symbol, within an equilateral triangle, is intended to alert the user to the presence of uninsulated "dangerous voltage" within the product's enclosure that may be of sufficient magnitude to constitute a risk of electric shock to persons



The exclamation point within an equilateral triangle is intended to alert the user to presence of important operating and maintenance(servicing)instructions in the literature accompanying the appliance.



**Warning :**

To prevent fire or shock hazard, do not expose units not specifically designed for outdoor use to rain or moisture.



**Attention:**

Installation should be performed by qualified service personnel only in accordance with the National Electrical Code or applicable local codes.



**Power Disconnect:**

Units with or without ON-OFF switches have power supplied to the unit whenever the power code is inserted into the power source; however, the unit is operational only when the ON-OFF switch is in the ON position. The power cord is the main power disconnect for all units.



**AC100~240V Power Cords**



**Note:**

This is a class A product. In a domestic environment this product may cause radio interference In which case the user may be required to take adequate measures.

**Note:**

Before installing and using this unit, please read this manual carefully. Be sure to keep it handy for later reference.

The information in this manual was current when published. The manufacturer reserves the right to revise and improve its products. All specifications are therefore subject to change without notice.



**Warning:**

Electrostatic-sensitive device. Use proper CMOS/MOSFET handling precautions to avoid electrostatic discharge.



**UNPACKING**

Unpack carefully.

This is electronic equipment and should be handled carefully.

Check to ensure that the following items are included;

- 1. Digital Video Recorder unit
- 2. User's manual
- 3. Power Cord
- 4. HDD tray key and screws
- 5. Built-in 160 GB HDD
- 6. RS232-RS485 converter

If an item appears to have been damaged in shipment, replace it properly in its carton and notify the shipper.



Do not place on uneven or unstable work surfaces. Seek servicing if the casing.

## Important Safeguards



**Read Instruction**---All the safety and operating instructions should be read before the unit is operated



**Retain Instructions**---The safety and operating instructions should be retained for future reference.



**Heed Warnings**—All warnings on the unit and in the operating instructions should be adhered to.



**Follow Instructions**—All operating and use instructions should be followed



**Cleaning**—Unplug the unit from the outlet before cleaning. Do not use liquid cleaners or aerosol cleaners. Use a damp cloth for cleaning



**Attachments**—Do not use attachment not recommended by the product manufacturer as they may cause hazards.



**Water and Moisture**—Do not use this unit near water—for example, near a bath tub, wash bowl, kitchen sink, or laundry tub, in a wet basement, near a swimming pool, in an unprotected outdoor installation, or any area which is classified as a wet location.



**Servicing**—Do not attempt to service this unit yourself as opening or removing covers may expose you to dangerous voltage or other hazards. Refer all servicing to qualified service personnel.



**Power Cord Protection**—Power supply cords should be routed so that they are not likely to be walked on or pinched by items placed upon or against them, paying particular attention to cords and plugs, convenience receptacles, and the point where they exit from the appliance.



**Object and Liquid Entry**—Never push objects of any kind into this unit through openings as they may touch dangerous voltage points or short-out parts that could result in a fire or electric shock, Never spill liquid of any kind on the unit.

# Table of Contents

<b>1. Product Features</b> .....	1
<b>2. Part Names</b> .....	2
2.1 Front panel.....	2
2.2 Back panel.....	3
2.3 Remote Controller.....	4
<b>3. Installation</b> .....	5
<b>4. Function keys illustration</b> .....	7
<b>5. Live Display</b> .....	10
5.1. System Login.....	10
5.2. Live Display and Basic Operation.....	10
<b>6. Setup Menu</b> .....	12
6.1. Setup Menu Flowchart.....	13
6.2. Camera Setup.....	14
6.2.1. Global Configuration.....	14
6.2.2. Camera-Advanced Setup .....	15
6.2.3. Camera-Global Setup .....	19
6.3. Calendar Setup .....	20
6.4. System Setup.....	21
6.4.1. System-General Setup .....	21
6.4.2. System-HDD Setup .....	22
6.4.3. System-Alarm Input Setup .....	23
6.4.4. System-Network Setup .....	25
6.4.5. System-Dial-up Setup .....	27
6.4.6. System-E-Mail Setup.....	27
6.5. Display Setup.....	28
6.5.1. Display-Main Monitor Sequence Setup .....	28
6.5.2. Display-Call Monitor Sequence Setup .....	29
6.6. Password Setup.....	30
6.7. Logout .....	31
<b>7. Playback and Search recorded images</b> .....	32
7.1. Video Playback.....	32
7.2. Search Recorded Images.....	33
7.2.1. Search by Time.....	33
7.2.2. Search by Location.....	33
7.2.3. Search by Event.....	34
7.2.4. Smart Search.....	34
<b>8. Video Archive and Preview</b> .....	35
8.1. Video Archive.....	35
8.2. Preview Archived Video.....	36
<b>9. Event Log</b> .....	37
<b>10. PTZ Control</b> .....	38
<b>11. View from Internet / Intranet</b> .....	39
Appendix A – Specifications .....	45
Appendix B – Time Lapse Mode Recording Time .....	46
Appendix C – Simulated Keyboard .....	48
Appendix D – Q & A .....	49

## 1. Product Features

- 16/8 CH Real-Time Digital Video Recorder
- Quadruple operation: Recording, Live view, Playback & Remote viewing
- 16/8 Color and/or B/W camera inputs (NTSC/PAL)
- MPEG-4 compression with resolution up to 720\*480 (NTSC) / 720\*576 (PAL)
- Real time recording (up to 25/30 FPS) per channel
- Real time live display (up to 25/30 FPS) per channel
- Real time playback (up to 25/30 FPS) per channel
- 16/13/10/9/7/4 windows or full-screen display
- 4 audio inputs, 1 audio output.
- Synchronized video & audio
- Video/audio storage in 1 built-in IDE HDD, 1 hot swappable IDE HDD
- Programmable storage for highest surveillance availability.
- 1 IDE CD-RW for video/audio backup.
- Non-editable video/audio data.
- Motion detection with programmable area and sensitivity for each camera.
- Alarm processor with configurable triggering conditions and reactions
- Alarm history log for Video Loss, Motion, Alarm input, etc.
- Pre-record time: up to 10 seconds.
- Sophisticated PTZ control functions, including Pan, Auto pan, Tilt, Zoom, Focus, Speed, Preset locations, Sequence, etc.
- RS232 ports for modem ( Modem function reserved ) connection and PTZ control.
- Optional SCSI connector for additional backup devices.
- Ethernet connector for internet/intranet access.
- Remote alarm notification via e-mail, dial-out, etc.
- ActiveX support for third-party software integration & networking CCTV applications.
- Multi-level password to ensure high degree of security.
- Multi-lingual support.
- TV monitor out and VGA monitor out
- Call (spot) monitor out
- Front panel LCD & LEDs
- Input devices: Keypad & Jog-shuttle, and I/R remote controller (1 I/R remote controller can control up to 4 eDRs)
- Built-in Compact Flash, power off data protection, power on and run
- Built-in RTC
- Hardware WDT

## 2. Part Names

### 2.1 Front Panel

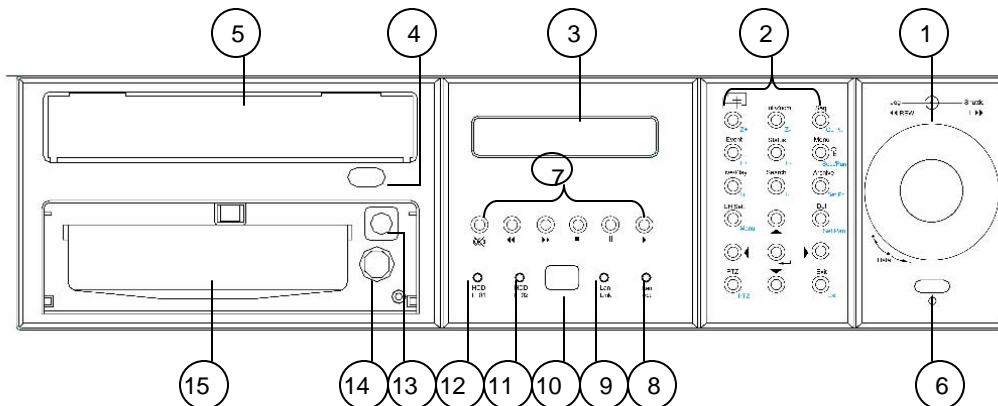

#### 1 Jog Dial (inner) and Shuttle Ring (outer)

##### Jog Dial:

A. Rotate in paused playback to move forward or backward to the next recorded image

B. In Setup Menu, rotate to select the options in the column (Same as ▲ ▼ keys)

##### Shuttle Ring:

A. Rotate in playback to search the recorded images in variable speed.

B. In Setup Menu, rotate to select the options in the column (Same as ◀ ▶ keys)

#### 2 Function Keys Panel

General Mode Panel(white) and PTZ Control Panel (Cyan). Please refer to Chapter 5 for detail function.

#### 3 LCD Panel

To display the Date/Time, Recording status, etc.

#### 4 Eject Button

Press to ▲ eject CD-RW disc tray.

#### 5 CD-RW

Built-in CD-RW.

#### 6 Power Switch and Indicator

Press to turn On/Off the power.

#### 7 Playback Buttons

- ▶ Press to start playback
- ⏸ Press to pause playback
- Press to stop playback
- ▶▶ Press to fast forward playback
- ◀◀ Press to fast rewind playback
- 🔇 Press to mute status On/Off

#### 8 LAN Active Indicator

Flashed when LAN is accessed.

#### 9 LAN Link Indicator

Illuminates when LAN is connected.

#### 10 IR Receiver

For IR Remote Controller (ERC100)

#### 11 HDD I02 Indicator (Internal HDD)

Illuminates when HDD I02 (hot-swappable) is accessed.

#### 12 HDD I01 Indicator (Internal HDD)

Illuminates when HDD I01 (built-in) is accessed.

#### 13 HDD Tray Lock

Lock the tray to enable the HDD I02 application.

#### 14 DVR ID Switch

Switch the controlled ID (DVR1~DVR4) for ERC100 controller. The default setting is DVR 1.

#### 15 HDD Tray

HDD I02 (hot-swappable)

## 2.2 Back Panel

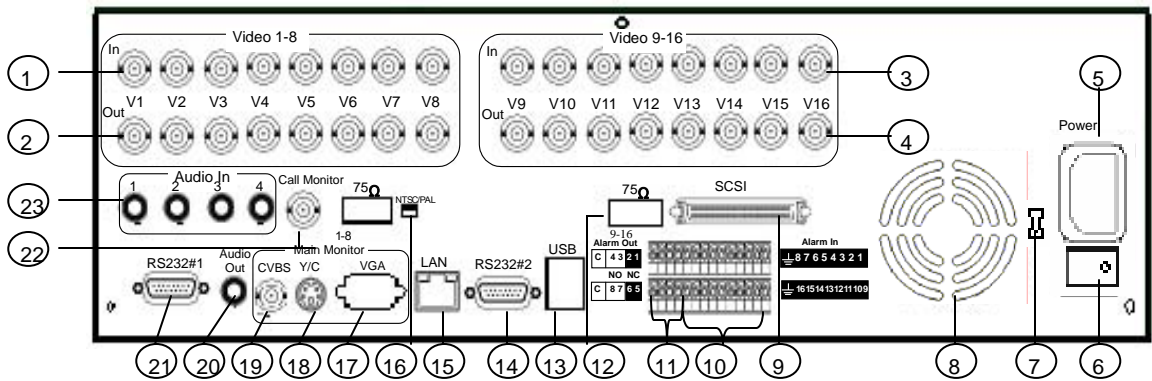









- ① **Video Input Connectors** (Video In 1-8): BNC connectors for video input 1-8
- ② **Video Output Connectors** (Video Out 1-8): BNC connectors for video looping out 1-8
- ③ **Video Input Connectors** (Video In 9~16): BNC connectors for video input 9~16 (eDR1680)
- ④ **Video Output Connectors** (Video Out 9~16): BNC connectors for video looping out 9~16
- ⑤ **Main Power Socket:** The main power input.
- ⑥ **Power Switch:** Power On/Off.
- ⑦ **Power Selector Switch:** 115V AC or 230V AC selector switch. **Warning: To avoid damaging the system, set this switch before plugging in the power plug.** Use a screwdriver to set the switch to the correct position so that the number shown is the same as the local AC voltage.
- ⑧ **Cooling Fan**
- ⑨ **SCSI Connector:** For connecting the optional extension unit. (Reserved)
- ⑩ **Alarm Inputs:** Connect to alarm inputs 1-16 and 2 common grounds
- ⑪ **Alarm Outputs:** Connect to 4 Normally Closed alarm outputs (1,2,5,6), Normally Open alarm outputs (3,4,7,8) and 2 common grounds.
- ⑫ **75ohm Termination 9-16:** The termination should be set as On normally. However, if the corresponding camera is connected to other devices, please set it as off
- ⑬ **USB Connector:** Reserved.
- ⑭ **RS232 connector #2:** Connects to PTZ camera.
- ⑮ **LAN connector:** Connects to RJ45 LAN connector.
- ⑯ **Video System Switch:** NTSC / PAL manual switch. Please make sure to select the proper video system before system starts up
- ⑰ **Main Monitor VGA Output:** VGA connector
- ⑱ **Main Monitor Y/C Output:** Mini-Din S-Video connector
- ⑲ **Main Monitor CVBS Output:** BNC connector, connects to TV monitor input
- ⑳ **Audio Output Connector (Audio Out):** Audio output to an external device (Speakers)
- ㉑ **RS232 connector #1:** Connects to Modem (Modem Function Reserved)
- ㉒ **Call Monitor Output:** BNC connector for Call (spot) monitor
- ㉓ **Audio Input Connectors (Audio In 1-4):** Audio input from an external device (Mick)



## 2.3 Remote Controller

The ERC100 remote controller is an accessory to enhance the handy operations. You can do all the settings and operations by the remote controller. The effective distance is up to 10 meters without any obstacle.

- 1 Power Button**  
Main Power ON/OFF
- 2 Eject Button**  
Press to control the ejection insertion of the CD-RW disc tray.
- 3 ID Buttons**  
One Remote Controller can control up to 4 DVRs. Press the buttons to switch the controlled ID (DVR1~DVR4). The default setting is DVR 1.
- 4 Function Buttons**  
General Mode Panel (white), PTZ Mode Panel (Cyan)  
Please refer to Chapter 4 for detail functions operation.
- 5 Playback Buttons**
-  Press to stop playback
  -  Press to adjust the audio volume low
  -  Press to adjust the audio volume high
  -  Press to mute status On/Off
  -  Press to start playback
  -  Press to pause playback
  -  Press to fast forward playback
  -  Press to fast rewind playback

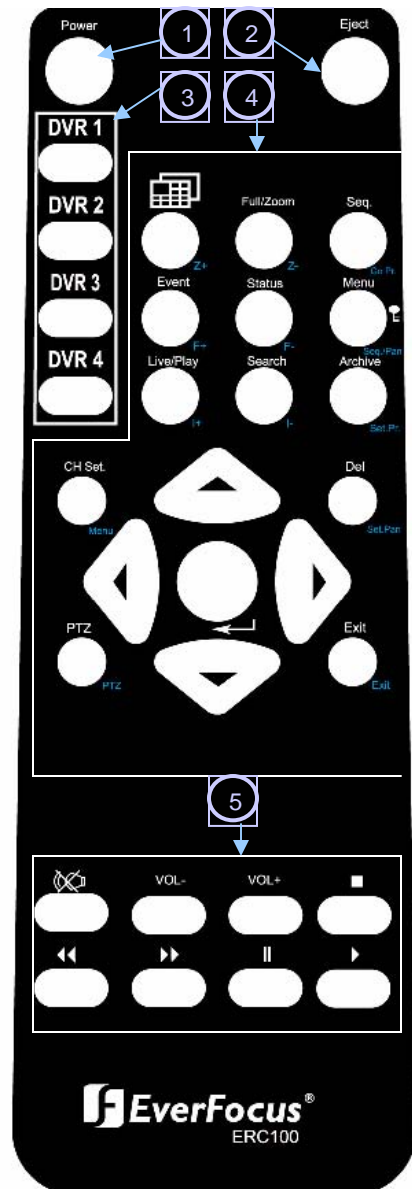

### 3. Installation

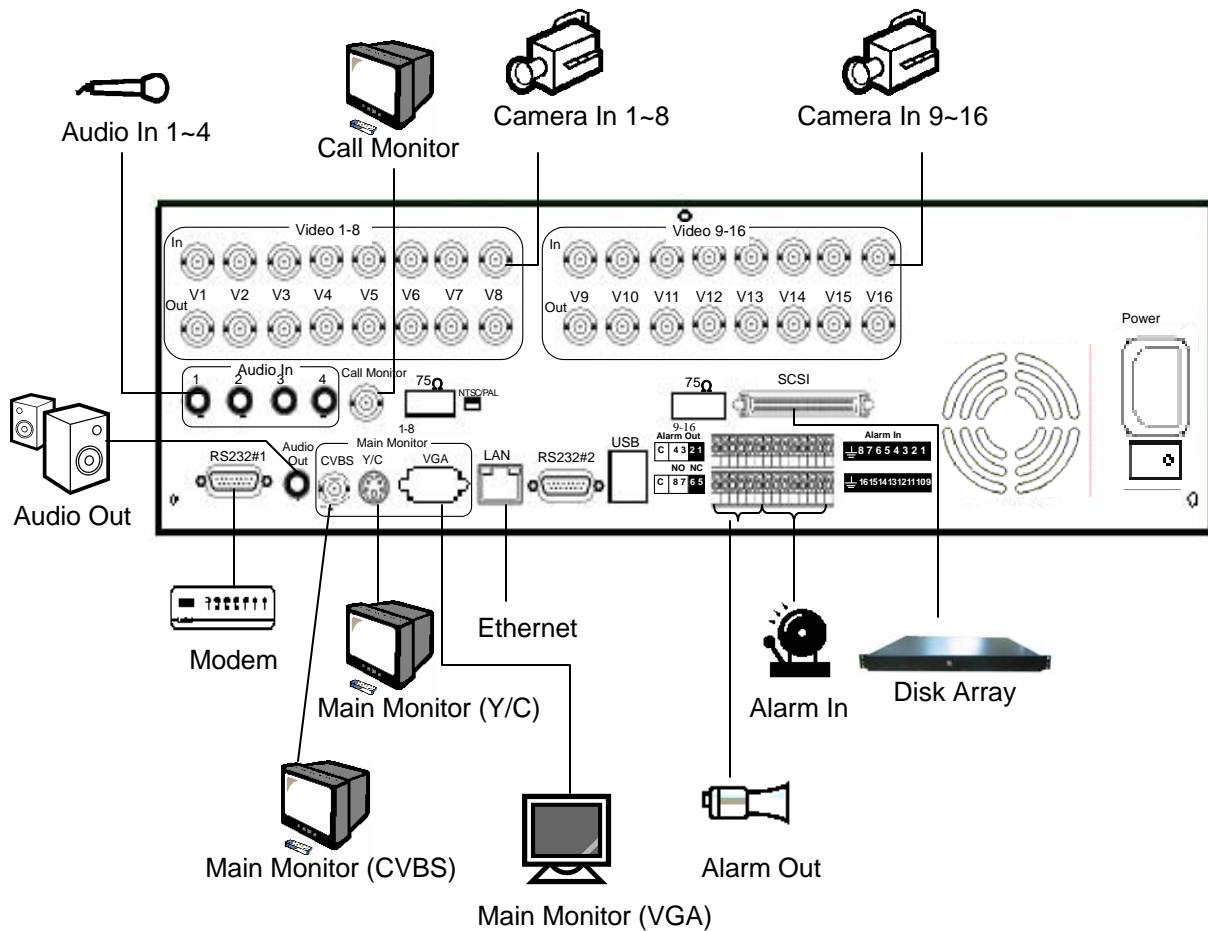

#### **Basic Connection**

##### **Cameras**

Connect each camera video input connector to the video output from a camera or other composite video source.

##### **Main TV Monitor**

Connect the Main monitor output connector to a TV monitor. The TV monitor displays selected live or recorded cameras in any available format.

##### **Power**

Plug the 110V AC or 220V power source into the power socket.

## **Optional Connection**

### **VGA Monitor**

Connect the VGA monitor output connector to a VGA monitor. The VGA monitor displays selected live or recorded cameras in any available format.

### **Call Monitor**

Connect the Call monitor output connector to a TV monitor. This monitor displays the full screen images of cameras associated with alarms or images from the installed cameras sequentially.

### **Alarm In**

Connect Alarm In 1-16 to NC or NO type of alarm signals. Please make sure to setup the software configurations of Alarm In accordingly.

### **Alarm Out**

Connect Alarm Out 1,2,5,6 to NC type of alarm signals, Alarm Out 3,4,7,8 to NO type.

### **Microphone/Speaker**

Connect the microphone/speaker or other audio devices to the Audio In/Audio out connector.

### **PTZ Camera**

Connect a PTZ camera to the RS-232 (Com#2) connector at system start up.

### **Ethernet**

The system is enabled control from the PC via Ethernet. Connect the LAN connector to a standard RJ45 connector Ethernet cable. Shown in below is an example of the connection. .

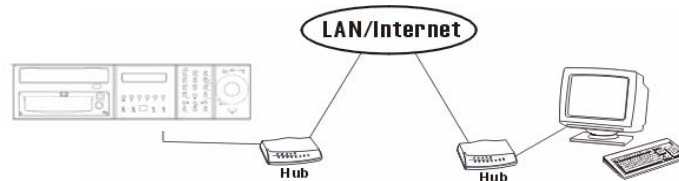

### **Modem ( Modem Function Reserved)**

The system is enabled control from the PC via modem. Connect the RS 232 Connector (Com#1) to a modem. Shown in below is an example of the connection.

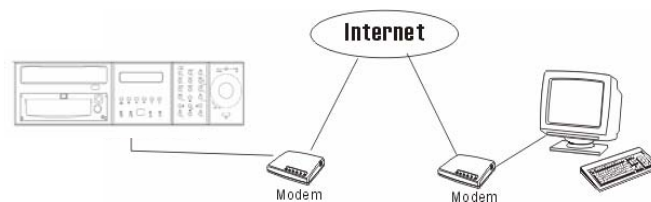

### **ISDN**

The system is enabled control from the PC via ISDN. Connect the ISDN TA device to the RS 232 connector (Com#1).

### **Disk Array**

It is allowed to connect additional hard disk array (EDA400) for extensional storage.

## 4. Function Keys Illustration



The Function Key Panel can operate 2 levels function-General Mode and PTZ Control Mode.

The levels are distinguished by icon colors:  
**General Mode – White** ( For EDR1680 operation)  
**PTZ Control Mode– Cyan** (For extensional PTZ camera if connected)

The default panel function is under General Mode. Press "PTZ" button to switch to PTZ control function. Press the buttons again to switch back to General Mode.

On main monitor display, there is a icon shown on the right lower corner. It shows the operation mode.

**G** General mode    **P** PTZ control mode

### 4.1 **G** General mode operation.



Press to change display split mode according to following cycle.



**Full/Zoom** Switch the focus window to full screen mode. Press again to Digital Zoom-in (X2) the selected area (Show X2 at the right lower corner on the display). Press again to return to previous static display. On Full screen display, you may also press  to return to previous static display.

**Seq.** Press to toggle between Sequence Mode and Static Mode (Show **SEQ** at the right lower corner of screen). Press again to return to static mode.

**Note:** In Seq mode, press Status to display Date/Time, HDD storage status. Press Menu, Event, Archive & CH Set, return to Static Display.

**Event** Press to appear Event Log Dialog. Press Exit to return. Use ◀ ▶ buttons or **Shuttle** to move the focus among items, ▲ ▼ or **Jog** to select option from the list.

**Note:** Press **Del** button can delete selected event list.

**Status** There are four types of status display on the bottom of the screen. Press to display Date/Time & HDD storage status. Press again to display Date/Time & Camera Status. Press again to display Date/Time & Alarm Inputs. Press again to control the Date/Time & Alarm Outputs. Press again to close the display.

Date/Time ← 2004/03/01 09:23:19 | HDD | I02 | 00% | I02 | 00% → HDD recorded percentage

→ Show the details if motion or alarm triggered.

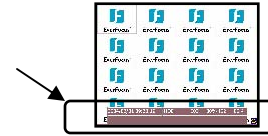
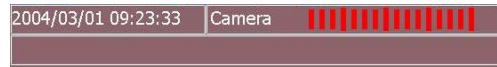

From left to right, each light stand for camera 1~16 (eDR880=1~8)

**Green**=Recording, **Grey**=Not Recording, **White**=Uninstall, **Yellow**=Motion, **Red**=Video Loss



From left to right, each light stand for Alarm Input 1~16 (eDR880=1~8)

**Green**=Normal, **Red**=Alarm triggered, **White**=Alarm In setting off



**Green**= Alarm out setting ON. **White**= Alarm out setting OFF

**Menu** Press to appear Setup Menu Dialog. Press Exit to return. In Setup Menu, press **Enter** button to enter the selected setup menu. Press ▲ ▼ or turn the **Jog** to move between the rows (For Up and Down).

Press ◀ ▶ or turn the **Shuttle** to move between main menu and submenu (For Left and Right). Please refer details for menu setting in chapter 6.

**Live/Play** Press to select between Live Mode or Playback Mode for focus channel.

Once select the Playback Mode, there is a ▶ show on the right upper corner of the selected channel. Press ▶ on the playback buttons to start playing back. Please refer to Chapter 7.1 for details.

**Search** Press to show Search Dialog for playback. Press Exit to return. Please refer to Chapter 7.2 for details.

**Archive** Press to show Archive Dialog for archiving to CD-RW. Press Exit to return. Please refer to Chapter 7.2 for details.

**CH Set** Press to set display camera on focus window. The dialog Cam1 will show on focus channel. Press ▲ ▼ or turn the **Jog** to select desired camera then press Enter to confirm setting. Press Exit to leave the dialog.

**Note:** Each channel is allowed only to show at once. It is not able to appear same camera in different windows in the same split display.

**Del** In Event Log Dialog, press to delete event list. In the column where need to edit character, press to delete one character each time (Same as Back Space).



- A. Press to move focus window Up, Down, Left & Right in live display mode.
- B. In setup Menu Dialog, press ◀ ▶ to move between columns (Same as Shuttle), press ▲ ▼ to select options (Same as Jog).
- C. Once the Simulated keyboard pop up, use ▲ ▼ to move among the alphanumeric keys. (Same as JOG)



- A. In Main Menu Setup, press to enter the Menu Dialog.
- B. Press to save the configuration.
- C. In Motion Detection Setup, press to toggle the Detect Area.
- D. Press to confirm the select channel in CH set operation.

**Exit** Press to return to upper level or leave current dialog without saving.

#### 4.2 **P** PTZ mode operation.

If there is a compatible PTZ camera connected to the DVR, you may switch between PTZ mode or General mode to operate the PTZ camera or DVR by pressing the PTZ button on the front panel.

(Current available models: **EverFocus** EPTZ series, ED2200. **Pelco** D protocol dome, C1487M.

**Kalatel** Cyber Dome. **Philips** Auto Dome. **Samsung** SCC-641P, SPD-2500. Subject to further notice if there is update support protocol)

- Z+** : Zoom In      **Z-** : Zoom Out
- F+** : Focus Far    **F-** : Focus Near
- I+** : Open IRIS    **I-** : Close IRIS

**GO Pr** : Goto Preset position. The  dialog will show on the focus camera. Use ▲ ▼ to select the preset position 1~10.

**Seq Pr** : Sequence tour on preset position 1~10. The  dialog will show on the focus camera. Use ▲ ▼ to select the dwelling time. Use ◀ ▶ to move to "OK" icon and press ◀ (Enter) to start.

**Set Pr** : Set Preset position. Pan/tilt/zoom the camera to desire position and then press this button, the dialog  will show on the focus camera. Use ▲ ▼ to select desired position and press ◀

(Enter) to confirm the setting position. Press "Exit" to leave the dialog.

**Auto Pan** : Press to start Auto Pan (left to right). The  dialog will show for further setting of the pan speed as you need. Move ( ◀ ▶ ) to "OK" icon to start auto pan.

**Set Pan** : Set Auto Pan Scope

◀ ▶ ▲ ▼ : Press to Pan/Tilt the camera (Pan=left/right, Tilt=up/down)

**Exit** : Press to leave setting dialog without saving.

## 5. Live Display

### 5.1 System Login

If the user does not login the system, he will be treated as a guest and can only view the live video and system status. To login the system, press **?** (Menu) button, the system login dialog and simulated keyboard will appear on screen as below allowing user to enter appropriate Login name and password. (For Operator, the factory default value for both is ***operator***, for Supervisor, the factory default value for both is ***supervisor***, for Administrator, the factory default value for both is ***admin***)

Username	<input type="text"/>	Login	
Password	<input type="text"/>		
S/N:	47159429	VER:	0.0



Use **▲ ▼** or **JOG** to move among the alphanumeric keys.

Press "**Enter**" button to confirm the selected character. Move to **<-** key and press "**Del**" button can delete the wrong character inputted if necessary.

Use **◀ ▶** or **Shuttle** to move to next row (Tab).

After finished all necessary inputs of username and password, use **◀ ▶** or **Shuttle** to move to "Login" icon and then press "**Enter**" button to login the system.

### 5.2. Live Display and Basic Operation

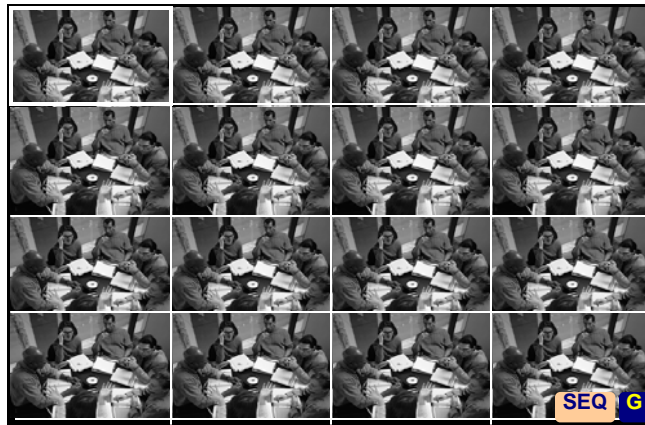

The screen above is the main display (monitor) after the system starts up and user login. The display resolution is 640x480(NTSC), 800x600(PAL). The display mode and function key panel status will be shown on the screen as following:

**G** General mode for DVR operation   **P** PTZ control mode   **SEQ** Sequential mode display

There is always a focus window surrounded by a white frame and it can be moved among split windows by using ▲▼◀▶ buttons.

▪ **Full/Zoom** Switch the focus window to full screen mode. Press again to Digital Zoom-in (X2) the selected area (Show X2 at the right lower corner on the display). Press again to return to previous static display. On Full screen display, you may also press  to return to previous static display.

▪ **Multi-window display**

Press  to change display different split windows according to following cycle.



▪ **Display Camera Setup**

Move the focus to the desired view window, press “CH Set” button and the camera selection Dialog  will appear on the screen. Press ▲ ▼ or turn the **Jog** to select desired camera then press “Enter” button to confirm setting. Press “Exit” button to leave the dialog.

**Note:** Each channel is allowed only to show at once. It is not able to appear same camera in different windows in the same split display.

▪ **Sequence Display Mode**

Press “SEQ” button to toggle between Sequence and Static Display Mode. Sequence can be displayed in various split windows. Press the Sequence Display Mode, user may view the Status and control the Alarm Outputs. The other function keys will be disabled until it’s switched back to Static Display Mode.

▪ **Status Display**

There are four types of status display on the bottom of the screen. Press to display Date/Time & HDD storage status, Date/Time & Camera Status, Date/Time & Alarm Inputs, Date/Time & Alarm Outputs accordingly.

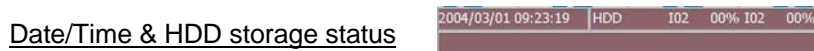

(Green=Recording, Grey=Not Recording, White=Uninstall, Yellow=Motion, Red=Video Loss)



(Green=Normal, Red=Alarm triggered, White=Alarm In setting off)

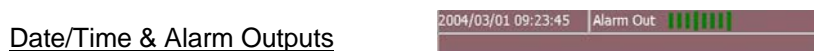

(Green= Alarm out setting ON. White= Alarm out setting OFF)

▪ **Clean Message / Alarm Reset**

When the alarm is activated, press **any button** first time to clean the alarm message.



## 6. Setup Menu

For entering the system setup menu, the user has to login as an Administrator level.

To setup the behaviors of the system, please press “**Menu**” button on the front panel. The Setup Menu shown as below will appear on screen.

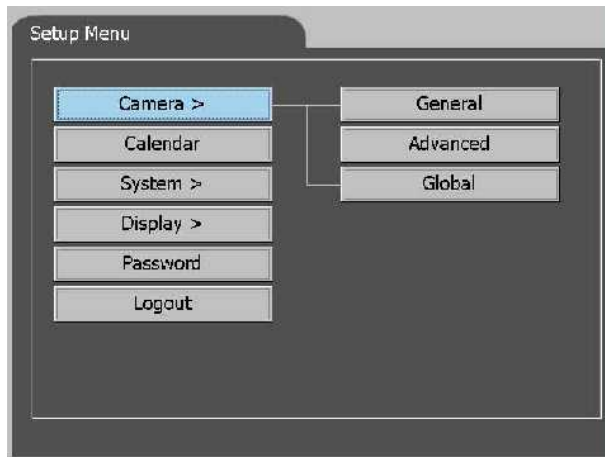

Use ▲▼ buttons or “**Jog**” to switch items in the row.

Use ◀▶ buttons or “**Shuttle**” to enter the submenu or return to upper level.

Press “**Enter**” button to close Setup Menu and enter the selected Configuration Dialog.

The “>” shows on the item means a submenu is available for further configuration.

Generally, in Configuration Dialog, ◀▶ buttons or “**Shuttle**” are used to move the focus among items, ▲▼ or “**Jog**” to select parameter from the list in the item and Exit to return to upper level.

If the simulated keyboard pop up for editing, use ▲▼ or “**Jog**” to move between the alphanumeric key. Press “**Enter**” to confirm the character.



## 6. 1 Menu flowchart

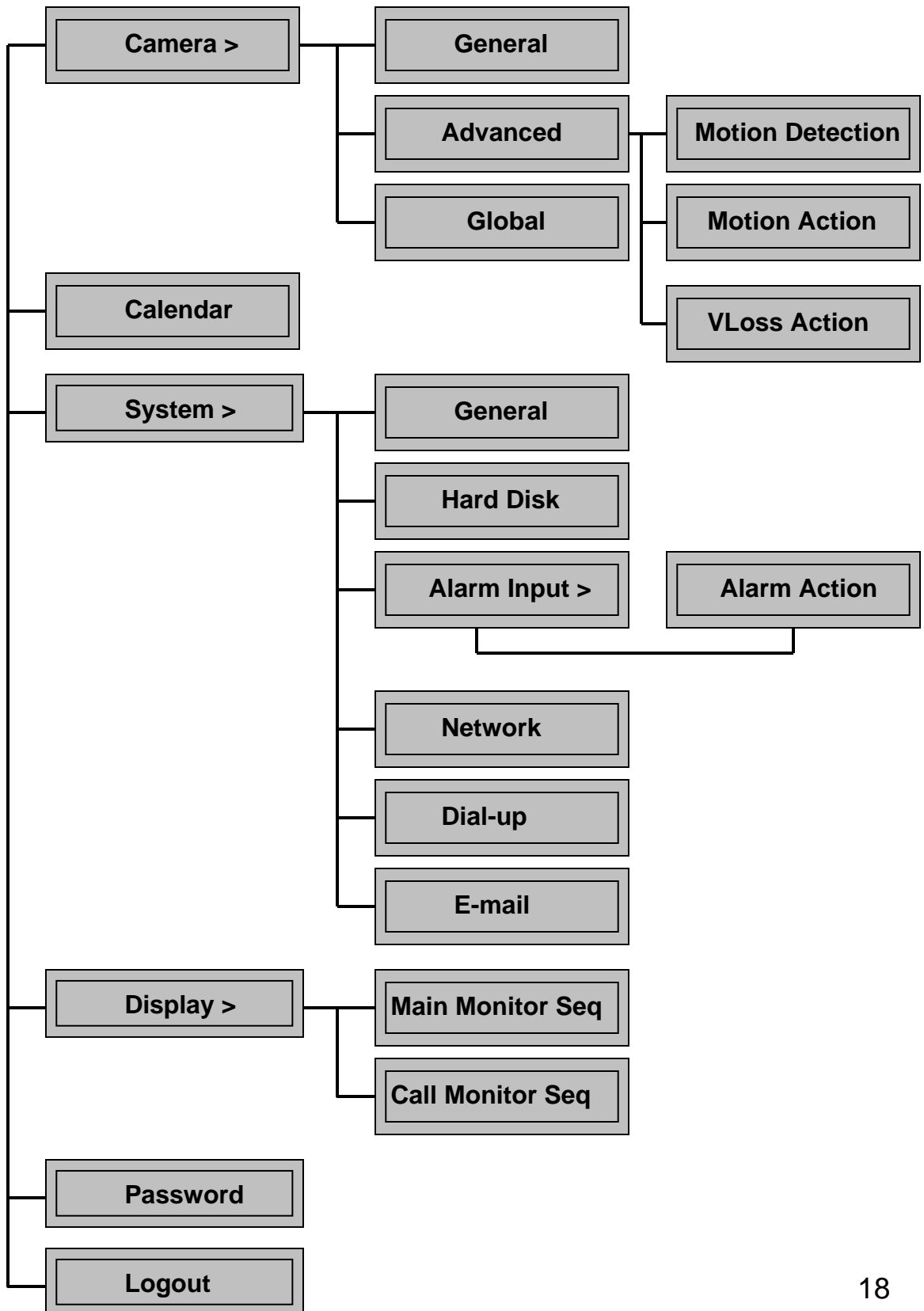

## 6.2 Camera Setup

### 6.2.1 Camera-General Setup

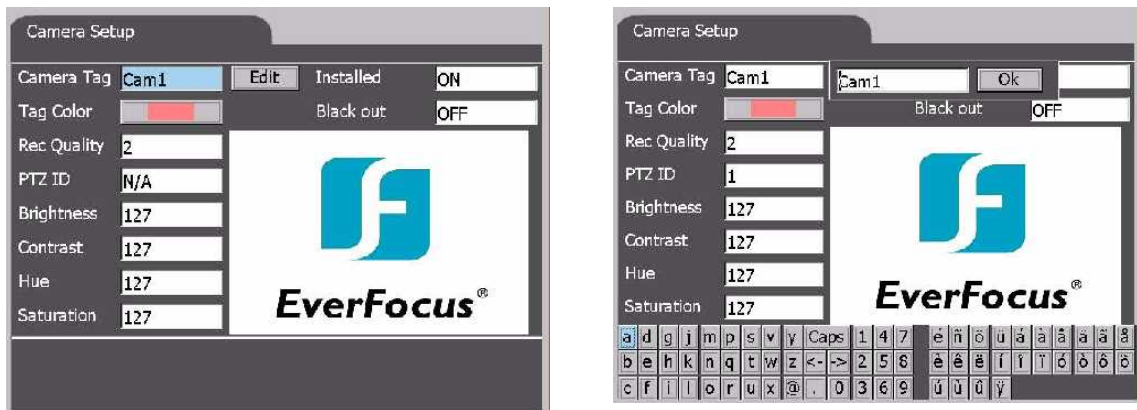

Figure 1

#### Camera Tag

Default settings are Cam1~Cam16 (Cam1~Cam8 for eDR880). User may move to “Edit” icon and press “Enter” button (Simulated keyboard will pop up once you start the edit function- **Figure 1**) to edit the camera title (total 10 characters available). Move to “OK” icon after finished and press “Enter” to confirm editing. Press “Exit” button to return to previous dialog.

#### Installed

Select “ON” if the corresponding camera is installed. All the other items are settable if the selected camera is installed. Default value is “ON”.

#### Tag Color

[10 options](#), select the desired camera tag color.

#### Blackout

Select “ON” to enable blackout the corresponding camera. The Guest and Operator levels are not able to view the live/playback image of the corresponding camera while the blackout function is selected. Default value is “OFF”.

#### Rec Quality (Recording Quality)

[6 options \(0~ 5\)](#), 5 is the best picture quality. The default value is 3.

#### PTZ ID

Select ID values while the installed camera is a PTZ device. Select N/A if the corresponding camera is not a PTZ device. Default value is “N/A”.

#### Brightness, Contrast, Hue, Saturation

[Adjustable for each camera](#)

## 6.2.2 Camera-Advanced Setup

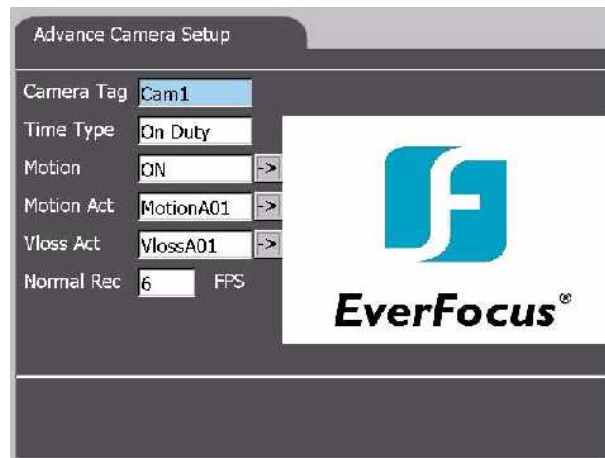

### Camera Tag

Select the corresponding camera Cam1~Cam16 for further setting.

### Time Type

4 options of time type are available. Default value is "On Duty". The setting of each time type please refer Chapter 7 Calendar setup menu.

### Motion

Select "ON/OFF" to enable/disable the Motion detection for corresponding camera. Default value is "ON". While the "ON" option is selected, the Config icon  will be enabled for user to configure the motion detection behavior. Move the focus to the icon and press "Enter" button to show the **Motion Detection Setup Dialog** as following:

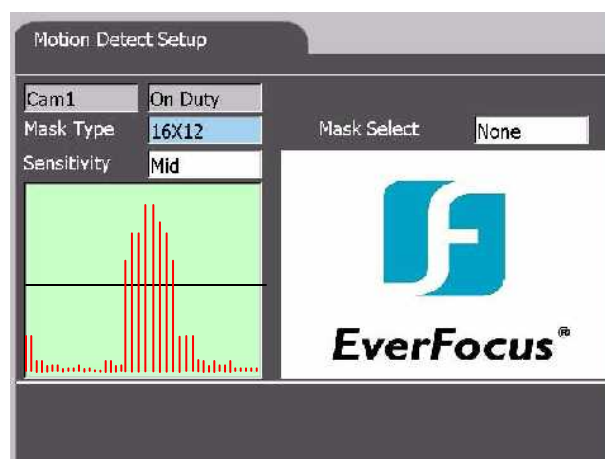

## Motion Detection Setup

### Mask Type

3 Options (4x3, 8x6, 16x12). Select the size of the mask that will be used to configure the motion detection area in the view window. Default value is 16x12.

### Mask Select

3 Options (Select All, Clear ALL, User define). Select the initial masked area.

### Sensitivity

3 Options (High, Mid, Low). Default value is Middle sensitivity.

### Detection Area Setting

Move the focus to the picture area. Use “Enter” button to toggle on/off the grid. Press “Exit” button to leave the picture grids area.

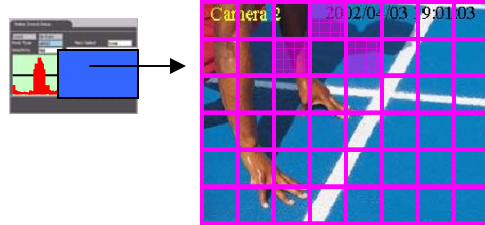

### Motion Act (action)

Maximum 4 options. Define the corresponding Motion Action while motion detection is enabled. Default value is “MotionA01”. Move the focus to the Config icon  will be enabled for user to configure the motion action behavior. Move the focus to the icon and press “Enter” button to show the **Motion Action Dialog** as **Figure 1**:

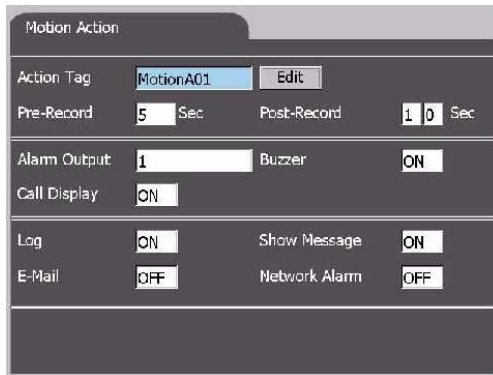

Figure 1



Figure 2

### Action Tag

Move the focus to “Edit” icon and press “Enter” button to edit action tag if necessary. Simulated keyboard will pop up once user starts the edit function (**Figure 2**) to edit the Action Tag (total 10 characters available). Move to “OK” icon after finished editing and press “Enter” button to confirm editing. Press “Exit” button to return to previous dialog

### Pre-Recording

Define the pre-recording time (0~10 seconds) for corresponding camera. Default value is 5 Sec.

**Post-Recording**

Define the post-recording time (0~99 seconds) for corresponding camera. Default value is 10 Sec.

**Alarm Output**

To define which Alarm Output will be triggered when the Motion Action is triggered. Alarm Output 1,2,5,6 are NC type of signal, Alarm Output 3,4,7,8 are NO type. Select N/A to disable alarm output. Default value is 1 (alarm output 1).

**Buzzer**

To activate (ON) buzzer or not (OFF) while motion is triggered. Default value is "ON".

**Call Display**

If Call Display function is enabled (ON), the call monitor will switch to the focus camera when the Motion Action is triggered. Default value is "ON".

**Log**

Log to event log list or not. Please refer to Event Log for the details. Default value is "ON".

**Show Message**

To display the alarm message or not when the Motion Action is triggered. Default value is "ON".

**E-mail**

To activate the E-mail notification function or not when the Motion Action is triggered. The E-mail will be sent to the defined receivers with an attached file, which contains the video graphic file of the triggered moment. Please refer to E-Mail Configuration for detail setting. (Note)

**Network Alarm**

Reserved for the PowerCom (Optional) users. Please refer to the PowerCom user manual for the detail information.

**Note: If a new motion action is happened during the post record time from the previous triggered motion, there will be no notification sending for the corresponding action.**

## VLoss Act (video loss action)

Maximum 4 options. Define the Video Loss Action for corresponding camera. Default value is "VlossA01". Move the focus to the Config icon  will be enabled for user to configure the video loss action behavior. Move the focus to the icon and press "Enter" button to show the Video Loss Action Dialog as Figure 1:

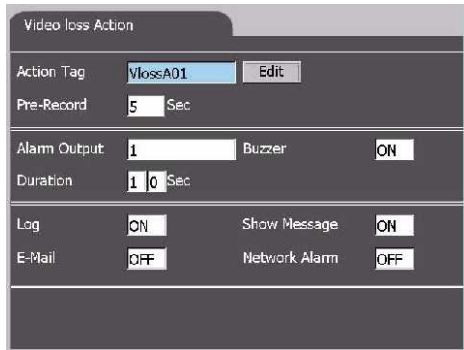

Figure 1



Figure 2

### Action Tag

Move the focus to "Edit" icon and press "Enter" button to edit action tag if necessary. Simulated keyboard will pop up once user starts the edit function (Figure 2) to edit the Action Tag (total 10 characters available). Move to "OK" icon after finished editing and press "Enter" button to confirm editing. Press "Exit" button to return to previous dialog

### Pre-Recording

Define the pre-recording time (0~10 seconds) for corresponding camera. Default value is 5 Sec.

### Post-Recording

Define the post-recording time (0~99 seconds) for corresponding camera. Default value is 10 Sec.

### Alarm Output

To define which Alarm Output will be triggered when there is video loss of corresponding camera. Alarm Output 1,2,5,6 are NC type of signal, Alarm Output 3,4,7,8 are No type. Select N/A to disable alarm output. Default value is 1 (alarm output 1).

### Buzzer

To activate (ON) buzzer or not (OFF) while motion is triggered. Default value is "ON".

### Duration

To define the duration time of the Alarm Output while there is video loss of corresponding camera.

### Log

Log to event log list or not. Please refer to Event Log for the details. Default value is "ON".

### Show Message

To display the alarm message or not when the Motion Action is triggered. Default value is "ON".

### E-mail

To activate the E-mail notification function or not when the Motion Action is triggered. The E-mail will be send to the defined receivers with an attached file, which contains the video graphic file in the triggered moment. Please refer to E-Mail Configuration for detail setting.

### Network Alarm

Reserved for the PowerCom (Optional) users. Please refer to the PowerCom user manual for the detail information.

### 6.2.3 Camera-Global Setup

The Global Setup allows administrator to define the common behaviors for all the installed cameras. The settings below will apply to all installed cameras.

Global Setup			
Time Stamp	ON		
Color	<input type="color" value="black"/>	Position	Upper Left
PTZ Model	<input type="text"/>		
Baud Rate	<input type="text"/>	Data Type	<input type="text"/>

#### Time Stamp

Select "ON" to enable Time Stamp, "OFF" to disable. While the Timestamp is On, user may define its Color and Position from the options shown on the screen.

#### Color

[10 options](#), select the desired time stamp color. Default color is black.

#### Position

4 options. Default position is Upper Left.

#### PTZ Model

Select the model if there is PTZ camera connected to the DVR. Support PTZ models:

EverFocus EPTZ series, ED2200

#### Baud Rate

Select the baud rate of PTZ.camera.

#### Data Type

Select the data type of the PTZ camera.



## 6. 3 Calendar Setup

There are total Ten years calendar and four Day Type available for users' setting. The DVR's behavior will work according to the setting schedule (Figure 1).

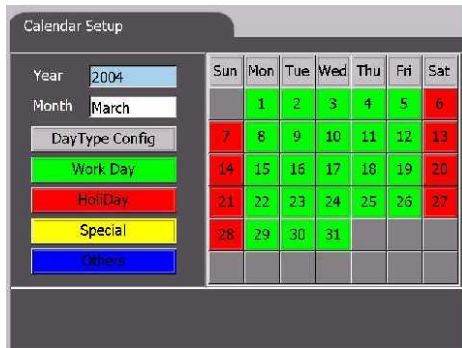

Figure 1

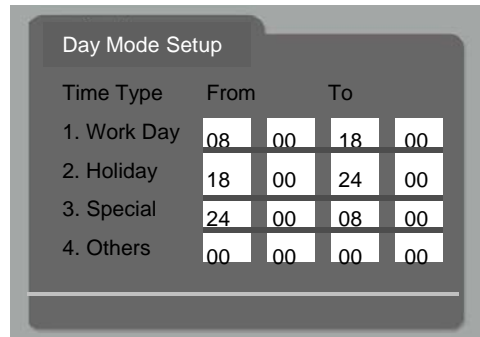

Figure 2

### Year

10 options. Default value is current year (2004).

### Month

12 options. Default value is current month (April).

### DayType Config

Move the focus on this item and press "Enter" to pop up the Day Mode Setup Dialog (Figure 2) to define the desired day type. Default values are Work Day, Holiday, Special and Others.

### Weekday Block

Once you move to the weekday block, use ▲▼ buttons or "Jog" to select the desired date. Press "Enter" to toggle between 4 day types. The color of selected date will change accordingly. Press "Exit" to leave the weekday block.

## 6. 4 System Setup

### 6.4.1 System-General Setup

The screenshot shows a 'General Setup' window with the following fields and buttons:

- System Time:** 20 0 4 / 0 3 / 0 1 0 9 : 1 0 : 0 9
- Daylight Saving Time:** Off
- Start:** 1st-Sun of Jan at 00:00
- End:** 1st-Sun of Jan at 00:00
- Language:** English
- Buttons:** Factory Setting, System Upgrade, Upload Config, Download Config

#### System Time

Set the system of the DVR.

**(After set the new system time, you need to reboot the machine to activate the setting.)**

#### Daylight Saving Time

Four options. Select the desired type if necessary.

#### Language

Multi-language support. Select the desired language to show on the display.

**(After changed the language, you need to reboot the machine to activate the setting.)**

#### Factory Setting

Reset all configuration to factory setting. All configuration set before will be ignored.

#### System Upgrade (Reserved)

To remote upgrade the S/W in the machine is connected successfully to the internet.

#### Upload Config

To upload the configuration from the CD. Please prepare a well downloaded CD and place it into the built-in CD-RW machine before applying this function.

#### Download Config

To download all configuration of this machine to a CD.

## 6.4.2 System-Hard Disk Setup

The screenshot shows a 'Hard Disk Setup' menu with the following settings:

- HDDs Auto Overwrite: OFF
- HDD Full Action: Trigger when HDDs are full and available space < 10 %
- Alarm Output: N/A
- Buzzer: OFF
- Duration: 10 Sec
- Log: OFF
- Show Message: OFF
- E-Mail: OFF
- Network Alarm: OFF

### HDDs Auto Overwrite

To set auto overwrite when HDD is full. Default value is "OFF". If the setting is "OFF", the DVR stop recording when HDD is full.

### HDD Full Action

To define the behaviors when HDD is full.

**Triggered when HDDs are full and available space <:** XX%. Default value is 10%.

**Alarm Output:** N/A, 1-8. Default value is N/A.

**Buzzer:** ON/OFF. Default value is OFF.

**Duration:** Duration time 00-99 seconds. Default value is 10 seconds.

**Log:** Log to event log list or not. Default value is "OFF".

**Show Message:** To display alarm message or not when HDD is full. Default value is "OFF".

**E-mail:** To activate the e-mail notification or not when HDD is full. Default value is "OFF".

### 6.4.3 System-Alarm Input Setup

The Alarm Input Setup allows the administrator to define the behaviors for each Alarm Input at each Time Type. There are up to 16 Alarm Inputs connected to the system. For each Alarm Input and each Time Type, you may enable/disable and select its corresponding Alarm Action (**Figure 1**). For most applications, 16 Alarm Inputs are enough to correspond to 16 Alarm Actions and hence 16 (Focus) Cameras.

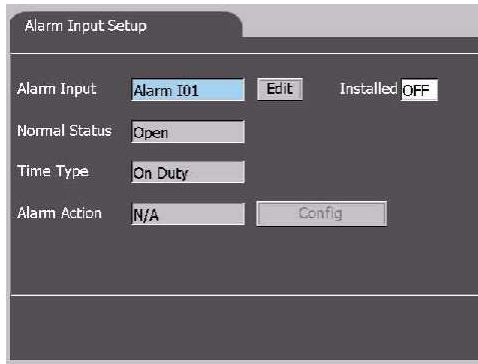

Figure 1

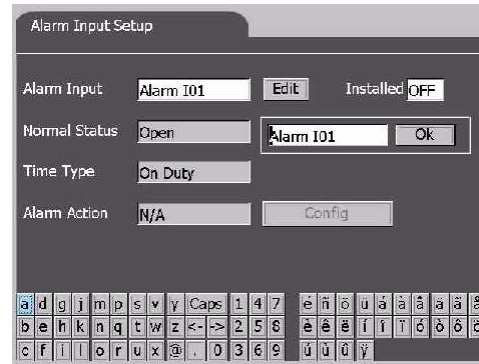

Figure 2

#### Alarm Input

To define alarm input behaviors AlarmI01~I16.

Move the focus to “Edit” icon and press “**Enter**” button to edit desired alarm input title. Simulated keyboard will pop up once user starts the edit function (**Figure 2**) to edit the alarm input (total 10 characters available). Move to “OK” icon after finished editing and press “**Enter**” button to confirm editing. Press “**Exit**” button to return to previous dialog

#### Installed

Select On if the corresponding Alarm Input is installed. The options below will be disabled if “OFF” is selected. Default value is “OFF”

#### Normal Status

Select Open or Close. Please check the signal types connected to the Alarm Input Terminal on the rear panel of the system. Default value is Open.

#### Time Type

Select Time Type, the Alarm Action is corresponding to the selected time type.

#### Alarm Action

N/A, AlarmA01~AlarmA16. Default value is N/A. If any alarm action is selected, the “Config” icon will be activated for further configuration. Move the focus to “Config” icon and press “**Enter**” to pop up the configuration dialog (**Figure 3**).

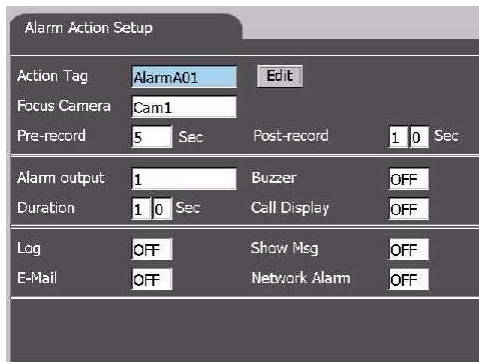

**Figure 3**

### Action Tag

Default value AlarmA01~AlarmA16. Move the focus to “Edit” icon and press “**Enter**” button to edit desired action tag. Simulated keyboard will pop up once user starts the edit function (**Figure 4**) (total 10 characters available). Move to “OK” icon after finished editing and press “**Enter**” button to confirm editing. Press “**Exit**” button to return to previous dialog.

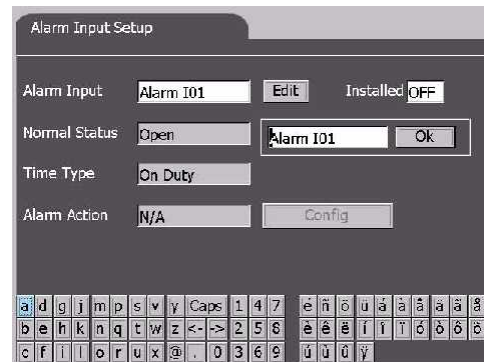

**Figure 4**

### Focus Camera

To define the camera that will respond to this Alarm Action. The default settings are Cam 1 for Alarm Action1, Cam 2 for Alarm Action 2, and so on.

### Pre-Recording

Define the pre-recording time (0~9 seconds) for corresponding camera. Default value is 5 Sec.

### Post-Recording

Define the post-recording time (0~99 seconds) for corresponding camera. Default value is 10 Sec.

### Alarm Output

To define which Alarm Output will be triggered when the alarm is triggered. Alarm Output 1,2,5,6 are NC type of signal, Alarm Output 3,4,7,8 are No type. Select N/A to disable alarm output. Default value is 1 (alarm output 1).

### Buzzer

To activate (ON) buzzer or not (OFF) while alarm is triggered. Default value is “OFF”.

### Duration

To define the duration time of the Alarm Output while alarm is triggered. Default value is “10” sec.

### Call Display

If Call Display function is enabled (ON), the call monitor will switch to the focus camera when the alarm is triggered. Default value is “OFF”.

### Log

Log to event log list or not. Please refer to Event Log for the details. Default value is “OFF”.

### Show Message

To display the alarm message or not when the alarm is triggered. Default value is “ON”.

### E-mail

To activate the E-mail notification function or not when the alarm is triggered. The E-mail will be sent to the defined receivers with an attached file, which contains the video graphic file in the triggered moment. Please refer to E-Mail Configuration for detail setting.

### Network Alarm

Reserved for the PowerCom (Optional) users. Please refer to the PowerCom user manual for the detail information.

## 6.4.4 System-Network Setup

The Network Configuration allows the administrator to define the parameters for communication between the system and outboard devices via Ethernet.

Field	Value
IP	169.254.134.155
Submask	255.255.255.0
Gateway	169.254.134.254
DNS	168.95.1.1

### IP address

Enter the reasonable parameters in the columns by using simulated keyboard. To obtain the IP address of the system, please contact your Internet Server Provider.

**Note: Only a fixed IP address is available for the system.**

### Submask

Enter the corresponding Subnet Mask.

### Gateway

For local network, leave the column blank to disable gateway. For Internet connection, enter the reasonable gateway IP address in the column.

### DNS

Enter the correct DNS for mapping Domain Names to IP addresses. The default setting is 168.095.001.001. The user can also define their local DNS for name-to-address translation, however, please make sure to define a correct DNS address.

After finished necessary input, move the focus to “Confirm” icon. Press “**Enter**” to confirm previous setting to activate network function.

## 6.4.5 System-Dial-up Setup

The Dial-up Setup allows the administrator to define the parameters for dial-up connection between the system and outboard devices through Modem (Modem Function Reserved) or ISDN. .

Dial-up Setup

Dialup Device: **Modem**

Dial In:

LocalIP: 192 168 0 1 RemoteIP: 192 168 0 2

Username: admin Password: admin

Channel: 2-B Channel EAZ/MSN:  → For ISDN only

Dial Out:

ISP Num:  Password:

Username:  **Confirm**

### Dialup Device

The system supports dial-up connection via **Modem** or **ISDN**. Select Modem or ISDN to setup the dial-up method. Select None to disable dial-up function. Default value is "Modem". Setup the dial-in details below as needed.

### Dial In

Users can dial in to the system for remote operation through the selected dial-up method. Enter the proper dial in details as required in the Dial in column. Users may use the default Local IP 192.168.0.1 and Remote IP 192.168.0.2 or set desired virtual IP.

### Dial Out

The system can automatically dial out through the selected dial-up method and connect to ISP if there's an event that needs to be delivered. Enter the proper dial out details as required in the Dial out column.

After finished necessary input, move the focus to "Confirm" icon. Press "**Enter**" to confirm previous setting to activate network function.

## 6.4.6 System-Email Setup

The E-Mail Setup allows administrator to define the related settings of E-mail notification function.

E-mail Setup

System Address

Send Mail To

Confirm

a d g j m p s v y Caps 1 4 7 é ñ ö u á à ä å ä ä ä ä  
b e h k n q t w z < - > 2 5 6 è é ë í î ï ó ô õ ö ò  
c f i l o r u x @ . 0 3 6 9 ú û ü ý

### System Address

Enter the reasonable system e-mail address. The address will be shown on the notification mail as the sender's address.

### Send Mail to

The system can send e-mail notification to up to 6 receivers for each action. Enter the receivers' e-mail addresses in #1 ~ #6 columns if necessary.

After finished necessary input, move the focus to "Confirm" icon. Press "**Enter**" to confirm previous setting to activate network function.



## 6. 5 Display Setup

### 6.5.1 Display-Main Monitor Seq Setup

The Main Monitor Sequence Configuration allows administrator to define the Display Pages in Sequence Mode display.

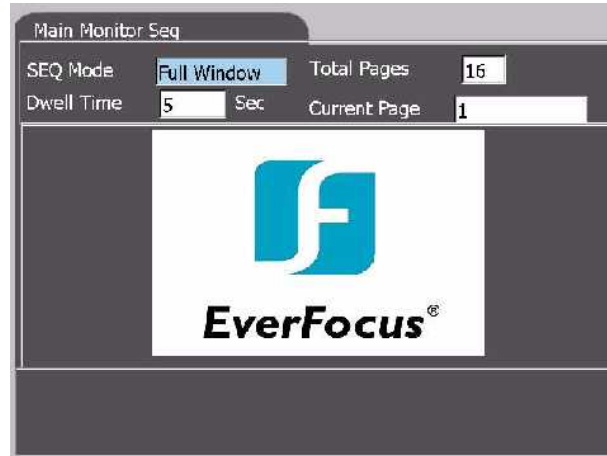

#### SEQ Mode

There are 7 Sequence Mode display types – Full, 4-Window, 7-Window, 9-window, 10-window, 13-window and 16-window. Select the Sequence Mode display type and the settings below are corresponding to the selected item. Default value is “Full Window”.

#### Total Pages

Select the desired total page number from the list. Maximum page numbers for each SEQ Mode: Full Window: 16 pages, 4-Window: 7pages, 7-Windows: 4 pages, 9-Windows: 3 pages, 10-Windows: 3 pages, 13-Window: 3 pages, 16-Window: 2 pages.

#### Dwell Time

Select the Dwell Time (1 ~ 99 Sec) for each selected page. Default value is “5” seconds.

#### Current Page

The total page number is varied by the above items. Select the desired page, and the selected page will be shown in the view window below.

The display camera can be defined from the view window. Use ◀▶ buttons or “Shuttle” to move focus to the view window.

While the focus is in the view window: Use ▲▼ or “Jog” to move between display. Press “CH Set” to set the corresponding window as desired channel if necessary (Please refer details of CH Set in Chapter 4.1). Press “Exit” to leave the view window and back to the previous item.

## 6.5.2 Display-Call Monitor Seq Setup

The Call Monitor Sequence Setup allows administrator to define the regular behavior of the call (spot) monitor.

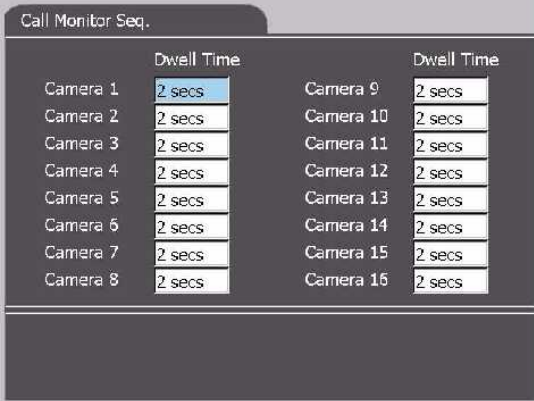

The screenshot shows a window titled "Call Monitor Seq." with a table of dwell time settings for 16 cameras. The table is organized into two columns, each with a header "Dwell Time". The first column lists cameras 1 through 8, and the second column lists cameras 9 through 16. Each camera has a dropdown menu set to "2 secs".

Camera	Dwell Time	Camera	Dwell Time
Camera 1	2 secs	Camera 9	2 secs
Camera 2	2 secs	Camera 10	2 secs
Camera 3	2 secs	Camera 11	2 secs
Camera 4	2 secs	Camera 12	2 secs
Camera 5	2 secs	Camera 13	2 secs
Camera 6	2 secs	Camera 14	2 secs
Camera 7	2 secs	Camera 15	2 secs
Camera 8	2 secs	Camera 16	2 secs

### Dwell Time

11 options (OFF, 1, 2, 3, 5, 10, 15, 20, 30, 45, 60 seconds). Each camera can set different dwelling time in sequential display.

## 6.6 Password Setup

The Password Setup allows the administrator to set the new Login names and passwords for the Administrator, Supervisor and Operator level. The system allows up to total 30 user accounts for all login levels. The default (Login, Password) for the Administrator is (admin, admin), the Supervisor is (supervisor, supervisor), the Operator is (operator, operator). (**Figure 1**)

ID	Name	Level
1	ADMIN	administrator
2	OPERA	operator
3	SUPER	supervisor
4		
5		
6		
7		
8		
9		

Figure 1

ID	Name	Level
1	ADMIN	administrator
2	OPERA	operator
3	SUPER	supervisor
4		
5		
6		
7		
8		
9		

Figure 2

### User ID

The existing user accounts are listed on the right charter. Use ▲▼ buttons or “Jog” to select from the list (1 ~ 30). The values below are corresponding to the selected item and can be configured.

### Level

3 options (Operator, Supervisor, Administrator). Use ▲▼ buttons or “Jog” to select the user level.

### Name / Password / Confirm

When the focus move to these items, simulated keyboard will pop up automatically for character input (**Figure 2**). Use ◀▶ buttons or “Shuttle” to select the desired character and press “Enter” button to input. Press “Exit” to quit the simulated keyboard. Move the focus to “Add” icon, press “Enter” button to confirm above setting.

### Note 1:

**There is no restriction for the numbers of each level. However, there must be at least one Administrator account.**

### Note 2:

**The Operator can operate all the functions related to live video display (including PTZ), view status.**

**The Supervisor can operate all the functions related to live video display (including PTZ), view status, image playback and archive.**

**The Administrator can operate all the function of the unit and define all configuration.**

## 6.7 Logout

To logout the system, press “Enter” button to invoke the Logout Dialog as shown in below.

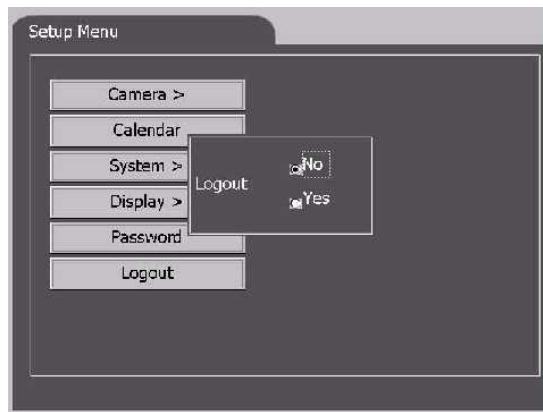

The default setting for confirm dialog is “No”. Use ◀▶ buttons or “Shuttle” to select the “Yes” to confirm , then press “Enter” to logout.

## 7. Playback and Search recorded images

### 7.1 Video Playback

#### Single Window Playback

On Static Mode, use ▲▼◀▶ buttons to move the focus to the designated view window, then press “Live/Play” button to start playback mode. There is an “▶” will show on the display. Press “▶” on the playback panel to start playback video. Press “Live/Play” button again to return to live mode.

#### Multi-window Playback

The system allows users to playback up to 16 channels at the same time. Repeat the above step to set desired view windows (or all windows) in Playback mode. Then press “▶” on the playback panel to start playback multi-window video. Press “Live/Play” button to designated view window to return to live mode.

#### Full Screen/2X Zoom In Display

Press “Full/Zoom” button to switch the focused window to full screen display. Press again to Digital Zoom In (x2) the selected area under the full screen mode. The enlarged frame can be moved by using ▲▼◀▶ buttons. Press “Full/Zoom” button again to return to static display. On Full Screen display, user may press “Exit” to return to static display without entering the 2X Zoom In display.

Example:

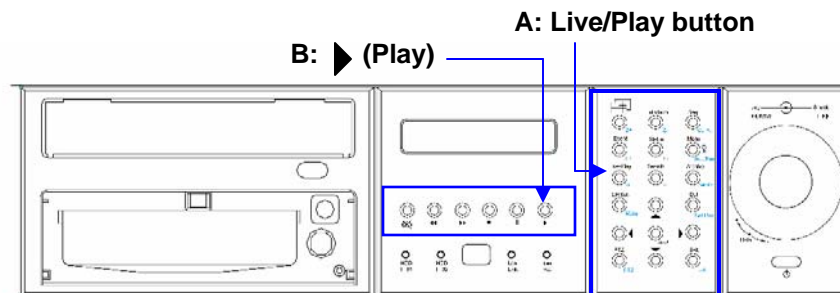
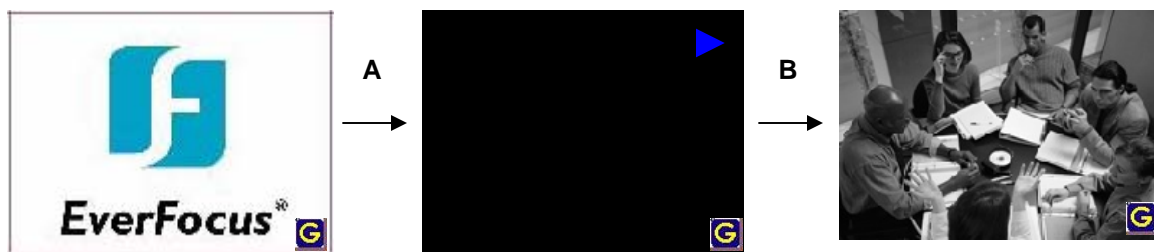
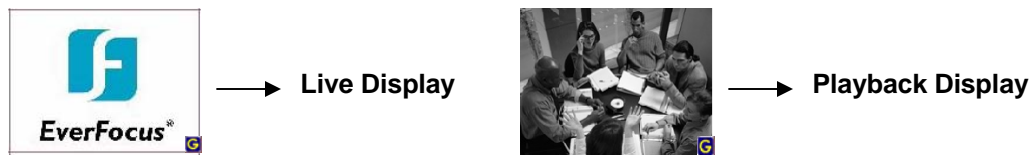

## 7.2 Search Recorded Images

The system provides 4 ways to search the recorded images for playback, **Search By Time**, **Search By Location**, **Search By Event** and **Smart Search**.

To search the recorded images, press “**Search**” button, the Image Search Dialog will appear on screen. Please refer to the following details. In general, ◀ ▶ buttons and “**Shuttle**” are used to move the focus among items, ▲ ▼ buttons and “**Jog**” to select option from the list in the item.

### 7.2.1 Search by Time

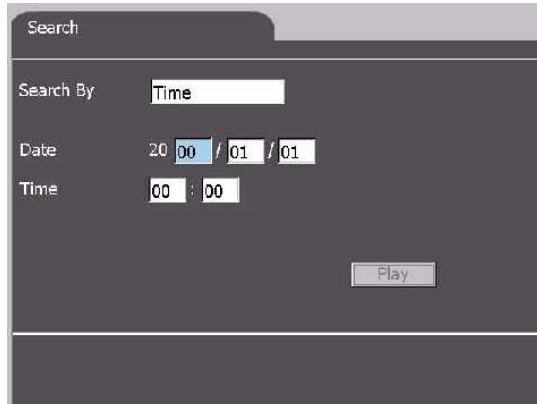

The screenshot shows a 'Search' dialog box with the following fields and controls:

- Search By:** A dropdown menu set to 'Time'.
- Date:** A date picker showing '20 00 / 01 / 01'.
- Time:** A time picker showing '00 : 00'.
- Play:** A button located at the bottom right of the dialog.

#### Operation:

1. Select to search by **Time**.
2. Select desired start **Date/Time**. Users do not have to input End Date/Time since users can stop playback any time during playing back.
3. Move the focus to “Play” icon, then press “**Enter**” to start playback the video.

**Note: If the search time is not valid, the “Play” icon will not be activated.**

### 7.2.2 Search by Location

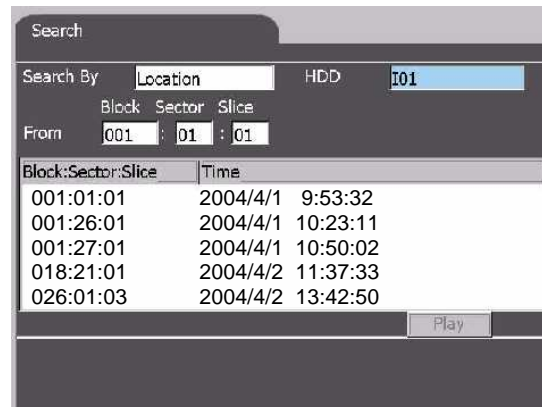

The screenshot shows a 'Search' dialog box with the following fields and controls:

- Search By:** A dropdown menu set to 'Location'.
- HDD:** A dropdown menu set to 'I01'.
- Block Sector Slice:** A table with columns for Block, Sector, and Slice.
- From:** A table with columns for Block, Sector, and Slice, showing values '001', '01', and '01'.
- Table:** A table with columns 'Block:Sector:Slice' and 'Time'.
- Play:** A button located at the bottom right of the dialog.

Block:Sector:Slice	Time
001:01:01	2004/4/1 9:53:32
001:26:01	2004/4/1 10:23:11
001:27:01	2004/4/1 10:50:02
018:21:01	2004/4/2 11:37:33
026:01:03	2004/4/2 13:42:50

#### Operation:

1. Select to search by **Location**.
2. Select the **HDD**.
2. Select desired location in the HDD. There are details on the charter of each segment with the Date/Time for reference. You may also select by moving to the desired list and press “**Enter**”.
3. Move the focus to “Play” icon, then press “**Enter**” to start playback the video.

**Note: If the search time is not valid, the “Play” icon will not be activated.**

### 7.2.3 Search by Event

Date	Time	Camera
2004/04/09	23:10:00	Cam 1
2004/04/09	23:15:00	Cam 2
2004/04/10	07:08:00	Cam 3
2004/04/10	08:51:10	Cam 4
2004/04/10	10:22:37	Cam 1

#### Operation:

1. Select to search by **Event**.
2. Select desired start event type-**Alarm, Vloss, Motion**.
3. Select the list number is the list. For example: 3/25.
4. Move the focus to “Play” icon and press “Enter” to start playback.

**Note: If the search time is not valid, the “Play” icon will not be activated.**

### 7.2.4 Smart Search

Search By: Smart Search Camera: Cam1  
From: 2000/01/01 00:00 Mask Type: 16X12 Mask: None  
Duration: 1 hr

Date/Time

EverFocus®

Play

#### Operation:

1. Select to search by **Smart Search**.
2. Select desired **Camera**. The selected camera will show on the display window of the dialog.
3. Select the desired **Date/Time**.
4. Select the **Mask Type**. 3 options-4x3, 8x6, 16x12
5. Select the **Mask**. 3 options-None, Select All, Delete All.
6. Select the **Duration** time for the search period.
7. Move the focus to view window and use ◀▶ buttons or “Shuttle” to move between the grid then press “Enter” to toggle the grid as desired area to be searched. Press “Exit” to leave the view window. The searched list will show on the left list charter.
7. Move the focus to “Play” icon and press “Enter” to start playback.

**Note: If the search time is not valid, the “Play” icon will not be activated.**

## 8. Video Archive and Preview

### 8.1 Video Archive

The playback video can be archived to various medias. Move the focus to the desired playback window, press “Archive” button to invoke the Video Archive Dialog shown as below. The selected playback window will be shown in the view window. Use ◀▶ buttons or “Shuttle” to move the focus among items, ▲▼ or “Jog” to select option from the list in the item.

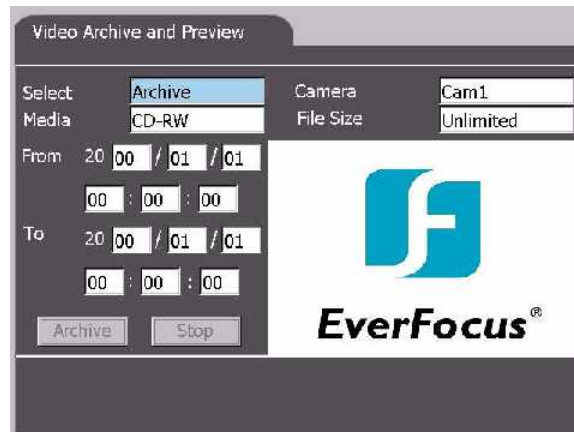

#### Operation:

1. Select **Archive** first.
2. Select desired Camera (Cam1~Cam16). The selected video will show on the view window in the dialog.
3. Select the media **CD-RW**.
4. Select the File Size: **10 options (Unlimited, 1.4, 5, 10, 20, 50, 100, 200, 300 and 500MB). the default value is Unlimited**
5. Move the focus to “Archive” icon and press “**Enter**” to start video archiving.
6. Press “**Stop**” icon to stop video archiving.
7. Press “**Exit**” button to return to main screen.

#### Note:

- ❑ **If the search time is not valid, the “Archive” icon will not be activated.**
- ❑ **During archiving, the focus will stay on “Stop” icon and the others options will be disable until you press “Stop” icon.**



## 8.2 Preview Archived Video

Refer to Chapter 8.1 video archive to invoke the dialog and select **Preview** to invoke the Video Archive and Preview Dialog shown as below. The selected playback window will be shown in the view window. Use ◀▶ buttons or “**Shuttle**” to move the focus among items, ▲▼ or “**Jog**” to select option from the list in the item.



### Operation:

1. Select **Preview** first.
2. Select desired Media (**CD-RW**). The selected video will show on the view window in the dialog.
3. Move the focus to “**Load**” icon and press “**Enter**” button to load the video from the CD-RW. The loaded video list will appear on the left charter of the display.
4. Move the focus to the desired list and the selected video will show on the view window. Press “**Enter**” to toggle the list.
5. Move the focus to “**Play**” icon and press “**Enter**” to start playback the archived video.
6. Press “**Stop**” icon to stop video archiving.
7. Press “**Exit**” button to return to Archive Dialog.

### Note:

- ❑ **If the search time is not valid, the “Archive” icon will not be activated.**
- ❑ **During archiving, the focus will stay on “Stop” icon and the others options will be disable until you press “Stop” icon.**

## 9. Event Log

There are 6 kinds of event logs: **Alarm, Motion, Video Loss, Hard Disk Full, Power on/off** and **User Log in/out**. To view the event log, press “**Event**” button to invoke the Event Log Dialog as shown in below. Use ◀▶ buttons or “**Shuttle**” to move the focus among items, ▲▼ or “**Jog**” to select option from the list in the item.

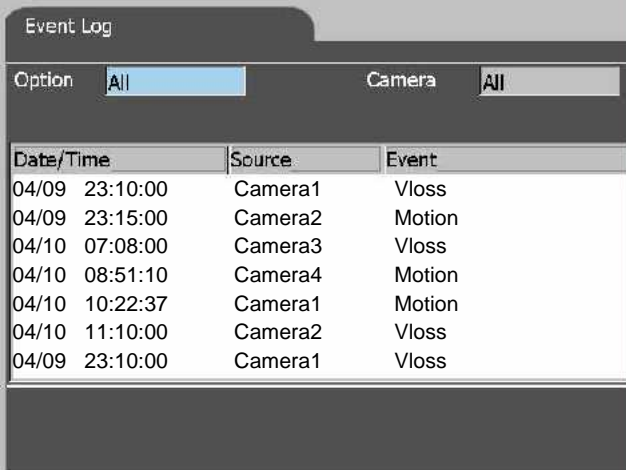

Date/Time	Source	Event
04/09 23:10:00	Camera1	Vloss
04/09 23:15:00	Camera2	Motion
04/10 07:08:00	Camera3	Vloss
04/10 08:51:10	Camera4	Motion
04/10 10:22:37	Camera1	Motion
04/10 11:10:00	Camera2	Vloss
04/09 23:10:00	Camera1	Vloss

### Operation:

1. Select **Option**: 7 options (All, Login, Alarm, HD, Motion, Vloss and Power) .
2. Select **Camera**: All cameras or any one of the cameras (Cam1~Cam16).
3. Move the focus to the Title Bar of the list (Date/Time, Source, Event) and use ▲▼ or “**Jog**” to Move between the list
4. To delete the record, highlight select the record while the focus is in the grid and press “**Del**” button. Press “**Exit**” to return to the Main Screen.

## 10. PTZ Control

The system support different models of speed dome (Current available models: EverFocus EPTZ series, ED2200. Pelco D protocol dome, C1487M. Kalatel Cyber Dome. Philips Auto Dome. Samsung SCC-641P, SPD-2500. Subject to further notice if there is update support protocol) that allows users to operate the basic function of PTZ camera through the front panel or remote AP.

To start PTZ operation, press "PTZ" button on the front panel. The PTZ operation mode **P** will show on the right corner of the display. The function button switch to PTZ operation mode.

**Z+** : Zoom In      **Z-** : Zoom Out  
**F+** : Focus Far    **F-** : Focus Near  
**I+** : Open IRIS    **I-** : Close IRIS

**GO Pr** : Goto Preset position. The  dialog will show on the focus camera. Use ▲ ▼ to select the preset position 1~10.

**Seq Pr** : Sequence tour on preset position 1~10. The  dialog will show on the focus camera. Use ▲ ▼ to select the dwelling time. Use ◀ ▶ to move to "OK" icon and press ↵ (Enter) to start.

**Set Pr** : Set Preset position. Pan/tilt/zoom the camera to desire position and then press this button, the dialog  will show on the focus camera. Use ▲ ▼ to select desired position and press ↵ (Enter) to confirm the setting position. Press "Exit" to leave the dialog.

**Auto Pan** : Press to start Auto Pan (left to right). The  dialog will show for further setting of the pan speed as you need. Move ( ◀ ▶ ) to "OK" icon to start auto pan.

**Set Pan** : Set Auto Pan Scope

◀ ▶ ▲ ▼ : Press to Pan/Tilt the camera (Pan=left/right, Tilt=up/down)

**Exit** : Press to leave setting dialog without saving.

## 11. View from Internet / Intranet

### Basic Operations and Login Display:

Go to the Internet Explorer, key in the network IP address, for example, <http://192.168.10.5> (must be the same IP address as the one assigned to the unit from the Network Setting Menu.)

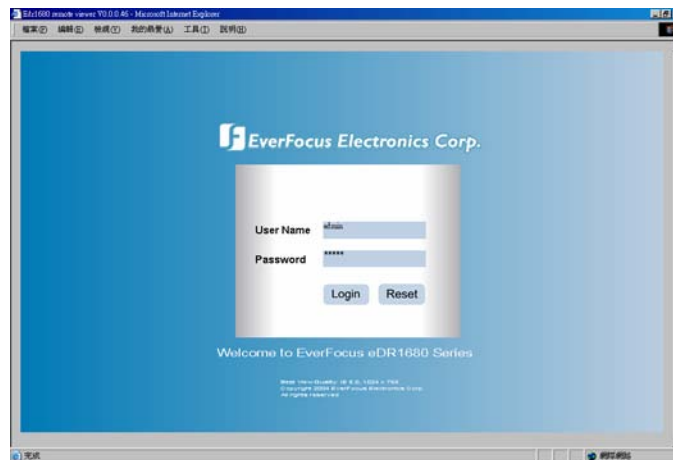

The “ digital video recorder login” page will show on the screen”

User’ must enter the correct user-name and password defined in the Network Setting menu.

For example:

Enter ADMIN for use name and ADMIN for password and then Click On “submit” to enter to system.

## Main Screen

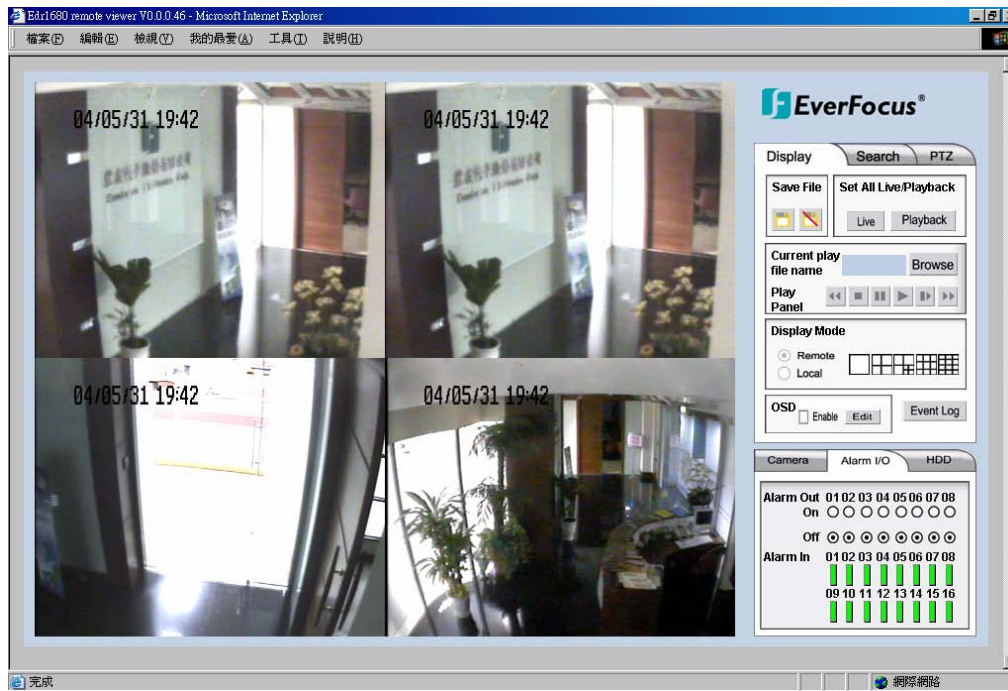















Above diagram is the main screen display.

The icons on the lower corner of the screen are mainly for control and Configuration, those on the right corner are for status indication.

If any icon is grayed, it means that the specific function is not accessible in the current mode.

The followings are a brief description for each of the icons.

- ①  **SAVE** : Start recording and save to file
- ②  **STOP** : Stop recording
- ③  **LIVE**: Show live camera
- ④  **PLAY**: Playing back the recorded video file
- ⑤  **Current Play file name**: input the file name for playing back
- ⑥  **BROWSE**: Pop up file selection window

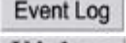
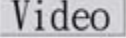
- 7  **REV. PLAY** : Reverses video display
- 8  **STOP** : Press this key to stop video display
- 9  **PAUSE**: Press this key to pause the Video display
- 10  **PLAY**: Playing the Video display
- 11  **Step Forward** the Video display
- 12  **Fast Forward**: fast forward the Video display
- 13  **Remote**      **Remote/Local**: select either Remote or Local display  
 **Local**
- 14  Full screen / Quad screen / Sever split screen / Nine split screen / Sixteen split screen view
- 15 **OSD**  **Enable**      **OSD**: Enable On Screen Display text
- 16  **OSD Edit**: Edit On Screen Display text and text color
- 17  **Event Log**: Switch to Event Display mode  
 **Video**: Switch to Video Display mode

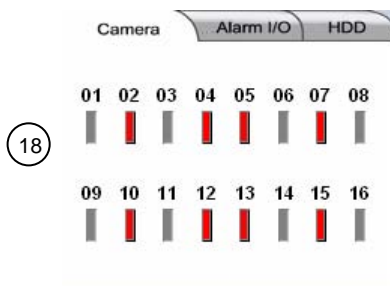

**Camera Mode:** Display current camera status  
**Green**=Recording, **Grey**=Not Recording, **White**=Uninstall,  
**Yellow**=Motion, **Red**=Video Loss

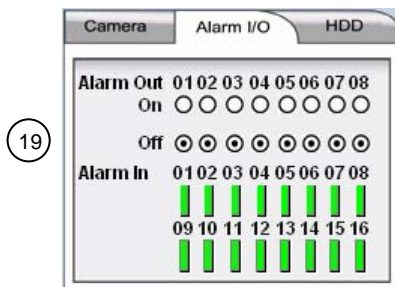

**Alarm I/O Mode:** Display current alarm status  
**Alarm Out:** **Black** = Alarm out setting ON.  
**White** = Alarm out setting OFF  
**Alarm In:** **Green**=Normal, **Red**=Alarm triggered,  
**White**=Alarm In setting off

20

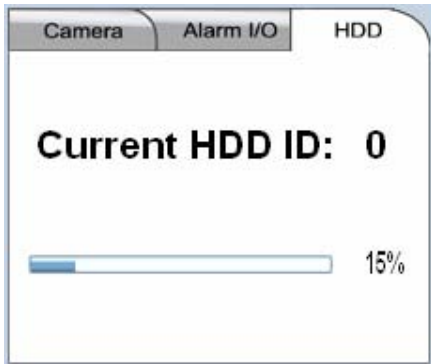

**HDD Mode:** Display current Hard Drive storage status

21

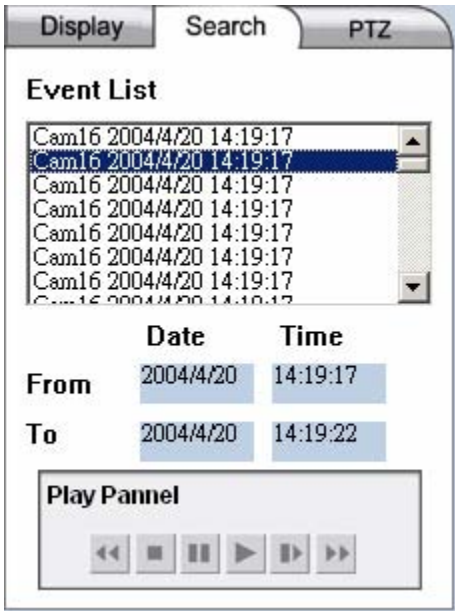

**Search Function Panel:** Search Mode showing Event List, Date Range, and Play Back Panel

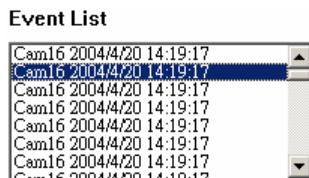

**Event List:** List the Event History and time stamps



**Date Time:** Ask user to input Date and Time begin to end time



**PLAY PANNEL** : Play Panel Control Area

- ◀◀ **REV. PLAY** : Reverses video display
- **STOP** : Press this key to stop video display..
- ⏸ **PAUSE**: Press this key to pause the Video display.
- ▶ **PLAY**: Playing back the Video .
- ▶▶ **Step Forward** the Video display.
- ▶▶▶ **Fast Forward**: fast forward the Video display.

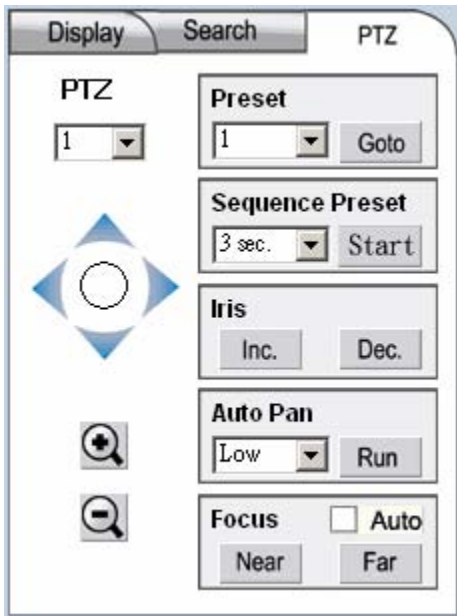

**PTZ Functions:** PTZ Panel to Preset, sequentially present camera, Iris control, Auto Pan control

22

**PTZ**



**PTZ Selection:** select the active PTZ from the Pull-Down Menu



**PTZ Control:** Four directions control. Up, Down, Left, Right





**Zoom In:** Zoom in to enlarge the displayed image



**Zoom Out:** Zoom out the displayed image



**Preset:** Preset Camera mode



**Sequence Preset:** set up the display Sequence



**Iris:** Iris Control, user can Increase or Decrease the IRIS setting by clicking **Inc.** or **Dec.**



**Auto Pan:** Select High/Middle/Low from the pull-down menu, then click **Run** to enable the Auto Pan function



**Auto Focus:** click check box  **Auto** to active Auto Focus

**Adjust Focus:** By clicking the **Near** or **Far** to adjust Focus

## Appendix A:

### LAN Functional Specification

#### Specifications:

Network Interface:	10/100 Mbps Ethernet (10/100 Base-T)
LAN controller Chip:	RealTek 8019
LAN Connector:	RJ-45
Protocol:	HTTP,TCP/IP.ICMP,ARP
Remote Access:	Standard browser such as internet Explorer / Netscape with JAVA support
Image Compression:	JPEG
<b>Used Ports:</b>	<b>80, 1111, 2222, 3333, 4444, 6666</b>
<b>Max. user numbers:</b>	<b>4</b>
<b>Frame rate:</b>	<b>max. 1,5 IPS depending on network conditions</b>

## Appendix B: Recording Time Table

Time Lapse Mode Recording Time (system storage:160GB)  
 (Estimated with typical image – low noise level)

NTSC	Unit: Hour	system storage (GB):			160
<b>Recording Speed (fps)</b>	<b>PICTURE QUALITY (KB)</b>				
	<b>Level 0</b>	<b>Level 1</b>	<b>Level 2</b>	<b>Level 3</b>	
	<b>6.72</b>	<b>7.92</b>	<b>8.72</b>	<b>9.92</b>	
	<b>480</b>	<b>13.8</b>	<b>11.7</b>	<b>10.6</b>	<b>9.3</b>
	<b>240</b>	<b>27.6</b>	<b>23.4</b>	<b>21.2</b>	<b>18.7</b>
	<b>160</b>	<b>41.3</b>	<b>35.1</b>	<b>31.9</b>	<b>28</b>
	<b>96</b>	<b>68.9</b>	<b>58.5</b>	<b>53.1</b>	<b>46.7</b>
	<b>48</b>	<b>137.8</b>	<b>116.9</b>	<b>106.2</b>	<b>93.3</b>
	<b>32</b>	<b>206.7</b>	<b>175.4</b>	<b>159.3</b>	<b>140</b>
	<b>16</b>	<b>413.4</b>	<b>350.7</b>	<b>318.6</b>	<b>280</b>
	<b>PAL</b>				
<b>Recording Speed (fps)</b>	<b>PICTURE QUALITY (KB)</b>				
	<b>Level 0</b>	<b>Level 1</b>	<b>Level 2</b>	<b>Level 3</b>	
	<b>6.72</b>	<b>7.92</b>	<b>8.72</b>	<b>9.92</b>	
	<b>480</b>	<b>13.8</b>	<b>11.7</b>	<b>10.6</b>	<b>9.3</b>
	<b>240</b>	<b>27.6</b>	<b>23.4</b>	<b>21.2</b>	<b>18.7</b>
	<b>160</b>	<b>41.3</b>	<b>35.1</b>	<b>31.9</b>	<b>28</b>
	<b>96</b>	<b>68.9</b>	<b>58.5</b>	<b>53.1</b>	<b>46.7</b>
	<b>48</b>	<b>137.8</b>	<b>116.9</b>	<b>106.2</b>	<b>93.3</b>
	<b>32</b>	<b>206.7</b>	<b>175.4</b>	<b>159.3</b>	<b>140</b>
	<b>16</b>	<b>413.4</b>	<b>350.7</b>	<b>318.6</b>	<b>280</b>

Time Lapse Mode Recording Time (system storage:320GB)  
 (Estimated with typical image – low noise level)

NTSC	Unit: Hour	<b>system storage (GB):</b>			320
<b>Recording</b>	<b>PICTURE QUALITY (KB)</b>				
<b>Speed</b>	<b>Level 0</b>	<b>Level 1</b>	<b>Level 2</b>	<b>Level 3</b>	
<b>(fps)</b>	6.72	7.92	8.72	9.92	
480	27.6	23.4	21.2	18.7	
240	55.1	46.8	42.5	37.3	
160	82.7	70.1	63.7	56	
96	137.8	116.9	106.2	93.3	
48	275.6	233.8	212.4	186.7	
32	413.4	350.7	318.6	280	
16	826.7	701.5	637.1	560	
<b>PAL</b>					
<b>Recording</b>	<b>PICTURE QUALITY (KB)</b>				
<b>Speed</b>	<b>Level 0</b>	<b>Level 1</b>	<b>Level 2</b>	<b>Level 3</b>	
<b>(fps)</b>	6.72	7.92	8.72	9.92	
480	27.6	23.4	21.2	18.7	
240	55.1	46.8	42.5	37.3	
160	82.7	70.1	63.7	56	
96	137.8	116.9	106.2	93.3	
48	275.6	233.8	212.4	186.7	
32	413.4	350.7	318.6	280	
16	826.7	701.5	637.1	560	

## Appendix C: Simulated Keyboard

There are situations that the user will be asked to enter a numeric or alphanumeric string. So, a Simulated Keyboard is designed for the user to use the mouse for all the operations. Please refer to the following diagram for the details.



## Appendix D: Q & A

Q: Do I need a fix IP address to set up the machine?

A: Yes, Only a fixed IP address is available for the system.

Q: What are IP address, Submask, Gateway, and DNS and what parameter should I use to set up the system ?

A: Please refer to chapter 6 of System-Network Setup section for more detail description. Since the parameters are different for each system, please contact your Network Administrator or ISP for correct IP address, Submask, Gateway, and DNS parameters.

Q: I am not able to sent out email

A: Please make sure the machine is connect to the Internet and refer to chapter 6 for System-Email Setup.

Q: How to setup time-lapse recording?

A: Please setup the Normal Recording rates for the Cameras at different Time Types. The normal recording rates are also time-lapse recording rates.

Q: How to setup event recording?

A: Please setup the Alarm Recording rates for the Cameras at different Time Types, the different Actions, and the enable/disable items for the Cameras and the Alarm Inputs. The alarm recording rates are also event-recording rates.

# ***EverFocus Electronics Corp.***

## **Head Office:**

12F, No.79 Sec. 1 Shin-Tai Wu Road,  
Hsi-Chi, Taipei, Taiwan  
TEL : +886-2-26982334  
FAX : +886-2-26982380  
[www.everfocus.com.tw](http://www.everfocus.com.tw)

## **USA Office:**

2445 Huntington Drive, San Marino,  
CA 91108, U.S.A.  
TEL : +1-626-844-8888  
FAX : +1-626-844-8838  
[www.everfocus.com](http://www.everfocus.com)

## **European Office:**

Albert-Einstein-Strasse 1  
D-46446 Emmerich, Germany  
TEL : +49-2822-9394-0  
FAX : +49-2822-939495  
[www.everfocus.de](http://www.everfocus.de)

## **Japan Office:**

1809 WBG Maribu East 18F,  
2-6 Nakase.Mihama-ku.  
Chiba city 261-7118, Japan  
TEL : +81-43-212-8188  
FAX : +81-43-297-0081  
[www.everfocus.com](http://www.everfocus.com)

## **Beijing Office:**

Room 609, Technology Trade Building,  
Shangri Information Industry Base,  
Haitian District, Beijing,China  
TEL : +86-10-62973336  
FAX : +86-10-62971432  
[www.everfocus.com.cn](http://www.everfocus.com.cn)



PN: MDRRG00120

## Free Manuals Download Website

<http://myh66.com>

<http://usermanuals.us>

<http://www.somanuals.com>

<http://www.4manuals.cc>

<http://www.manual-lib.com>

<http://www.404manual.com>

<http://www.luxmanual.com>

<http://aubethermostatmanual.com>

Golf course search by state

<http://golfingnear.com>

Email search by domain

<http://emailbydomain.com>

Auto manuals search

<http://auto.somanuals.com>

TV manuals search

<http://tv.somanuals.com>