



# **MAGNUM 1x7 LTO AUTOLOADER**

# **PRODUCT MANUAL**



1012581 Revision E

**COPYRIGHT** Copyright 2004 – 2006 by Exabyte Corporation. All rights reserved. This item and the information contained herein are the property of Exabyte Corporation. No part of this document may be reproduced, transmitted, transcribed, stored in a retrieval system, or translated into any language or computer language in any form or by any means, electronic, mechanical, magnetic, optical, chemical, manual, or otherwise, without the express written permission of Exabyte Corporation, 2108 55th Street, Boulder, Colorado 80301.

**DISCLAIMER** Exabyte Corporation makes no representation or warranties with respect to the contents of this document and specifically disclaims any implied warranties of merchantability or fitness for any particular purpose. Further, Exabyte Corporation reserves the right to revise this publication without obligation of Exabyte Corporation to notify any person or organization of such revision or changes.

**TRADEMARK NOTICES** Exabyte Corporation trademarks: Exabyte, EZ17, M2, VXA, and VXAtape are registered trademarks; ExaBotics, MammothTape, and SmartClean are trademarks; SupportSuite is a service mark.

Other trademarks: Linear Tape-Open, LTO, the LTO Logo, Ultrium and the Ultrium Logo are trademarks of HP, IBM, and Quantum in the US and other countries. All other product names are trademarks or registered trademarks of their respective owners.

**PART NUMBER** 1012581 Revision E

<b>REVISION HISTORY</b>	<b>Revision</b>	<b>Date</b>	<b>Description</b>
	A	September 2004	Initial release.
	B	December 2004	Updated Exabyte contact information, specifications, UL and FCC safety notices, changed Remote mode to Random mode, modified tape drive replacement instructions and packing instructions, updated warranty information.
	C	March 2005	Updated to add LTO-3 information. Deleted Limit Number of Cells description.
	D	September 2005	Added Appendix B, moved Error messages to Appendix C, updated the Troubleshooting section.
	E	October 2006	Added Ultra 160 terminator information, updated warranty, updated Home screen menu, new HH LTO-3 tape drive.

**NOTE:** The most current information about this product is available at Exabyte's web site ([www.exabyte.com](http://www.exabyte.com)).

**PRODUCT  
WARRANTY  
CAUTION**

The Magnum 1x7 LTO Autoloader by Exabyte® Corporation is warranted to be free from defects in materials, parts, and workmanship and will conform to the current product specification upon delivery. For the specific details of your warranty, refer to your sales contract or contact the company from which the autoloader was purchased.

The warranty for the autoloader shall not apply to failures caused by:

- ▶ Physical abuse or use not consistent with the operating instructions or product specifications.
- ▶ Repair or modification by any one other than Exabyte's personnel or agent in a manner differing from the maintenance instructions provided by Exabyte.
- ▶ Removal of the Exabyte identification label(s).
- ▶ Physical abuse due to improper packaging of returned autoloader.

If problems with the autoloader occur, contact your maintenance organization; do not void the product warranty by allowing untrained or unauthorized personnel to attempt repairs.



**Caution**

Returning the autoloader in unauthorized packaging may damage the unit and void the warranty. If you are returning the autoloader for repair, package it in its original packaging (or in replacement packaging obtained from your vendor.)

**CONTACTING  
EXABYTE**

<b>To obtain general information</b>	
Exabyte Corporate Headquarters	Exabyte Corporation 2108 55th Street Boulder, CO USA 80301 (303) 442-4333
World Wide Web	<a href="http://www.exabyte.com">www.exabyte.com</a>
<b>To obtain technical support</b>	
Exabyte Technical Support	<a href="http://www.exabyte.com/warranty">www.exabyte.com/warranty</a>
<b>To order supplies and accessories</b>	
Exabyte Sales Support	1-800-774-7172
	1-800-392-8273 (Exabyte Media)
<b>To return equipment for service (RMA Request)</b>	
Exabyte Service	<a href="http://www.exabyte.com/contact">www.exabyte.com/contact</a>

# NOTES



# Contents

<b>About This Manual</b> .....	<b>xiii</b>
<b>1 Product Overview</b> .....	<b>1</b>
Autoloader Features .....	1
Autoloader Components .....	2
<b>2 Installing the Autoloader</b> .....	<b>7</b>
Completing the Unpacking Process .....	8
Obtaining Accessories and Equipment .....	9
Preparing for Installation .....	10
Installing the Autoloader in a Rack .....	11
Assembling the Rails .....	12
Attaching the Rails to the Rack .....	13
Connecting the Autoloader to SCSI .....	15
Connecting the Autoloader to Ethernet .....	18
Powering On the Autoloader .....	19
Verifying the Hardware Installation .....	20
<b>3 Configuring the Autoloader</b> .....	<b>21</b>
Accessing Configuration Options .....	21
Setting Configuration Options .....	26
Checking the Setup .....	45
<b>4 Using the Remote Management Utility</b> .....	<b>47</b>
Accessing the Remote Management Utility .....	47
Viewing Information on the Home (Status) Page .....	49
Setting Configuration Options .....	53
Viewing Information on the Statistics Page .....	58
Running Diagnostics .....	59

<b>5</b>	<b>Autoloader Operation</b>	<b>61</b>
	Inserting and Removing Cartridges	62
	Loading and Unloading Cartridges in the Tape Drive	68
	Cleaning the Tape Drive	70
	Resetting the Autoloader	74
	Running System Demos	75
	Performing Diagnostic Tests	77
	Storing Cartridges	78
<b>6</b>	<b>Viewing Autoloader Information</b>	<b>79</b>
	Viewing Basic Autoloader Information	79
	Viewing Autoloader Sensor Readings	82
	Viewing Basic Tape Drive Information	85
	Viewing the Cartridge Inventory and Bar Code Information	86
	Viewing Cell Statistics	88
	Viewing the Event Log	90
<b>7</b>	<b>Maintenance</b>	<b>91</b>
	Replacing the Tape Drive	91
	Cleaning the Autoloader	99
	FTP—Autoloader Firmware Upgrade and Diagnostics	100
	LibTool—Autoloader Firmware Upgrade and Diagnostics	102
	LTOTool—Tape Drive Firmware Upgrade and Diagnostics	102
<b>8</b>	<b>Troubleshooting</b>	<b>103</b>
	Autoloader Troubleshooting	103
	Tape Drive Troubleshooting	107
	Backup Software Reports an Error	108
	Before Contacting Technical Support	110
	Advanced Troubleshooting	112
<b>9</b>	<b>Shipping the Autoloader</b>	<b>113</b>
	Preparing the Autoloader for Shipping	113
	Removing the Autoloader from the Rack	114
	Replacing the Shipping Key	115
	Packing the Autoloader	115

<b>A Specifications</b> .....	<b>119</b>
Storage Capacity .....	119
Size and Weight .....	119
Performance Specifications .....	120
Power Specifications .....	122
Environmental Specifications .....	123
Shipping Specifications .....	125
Safety and Regulatory Agency Compliance .....	125
<b>B Write Once, Read Many (WORM) Capability</b> .....	<b>129</b>
Overview .....	129
WORM Media .....	129
Requirements .....	131
TapeAlert Flags .....	131
Error Codes .....	132
<b>C Error Messages</b> .....	<b>133</b>
<b>Index</b> .....	<b>139</b>

# NOTES





# Figures

## 1 Product Overview

<b>Figure 1-1</b>	Magnum 1x7 LTO Autoloader front panel components . . . . .	2
<b>Figure 1-2</b>	Magnum 1x7 LTO Autoloader back panel components . . . . .	3
<b>Figure 1-3</b>	Magnum 1x7 LTO Autoloader internal components . . . . .	4

## 2 Installing the Autoloader

<b>Figure 2-1</b>	Label over shipping key . . . . .	8
<b>Figure 2-2</b>	Removing the shipping key . . . . .	8
<b>Figure 2-3</b>	Assembling the left-side rail . . . . .	12
<b>Figure 2-4</b>	Assembling the right-side rail . . . . .	13
<b>Figure 2-5</b>	Attaching the left-side rail to the rack . . . . .	13
<b>Figure 2-6</b>	Placing the autoloader on the rails . . . . .	14
<b>Figure 2-7</b>	Attaching the autoloader to the rails at the back of the rack . . .	15
<b>Figure 2-8</b>	SCSI connectors on the back of the autoloader. . . . .	17
<b>Figure 2-9</b>	Connecting the autoloader as the last device on the SCSI bus. .	18
<b>Figure 2-10</b>	Connecting the autoloader to an Ethernet network. . . . .	18
<b>Figure 2-11</b>	Location of the power switch and power connector . . . . .	19

## 3 Configuring the Autoloader

<b>Figure 3-1</b>	Autoloader LCD and keypad . . . . .	21
<b>Figure 3-2</b>	Operator panel buttons . . . . .	23
<b>Figure 3-3</b>	Autoloader menu organization. . . . .	25

## 4 Using the Remote Management Utility

<b>Figure 4-1</b>	Remote Management utility Status page. . . . .	48
<b>Figure 4-2</b>	Remote Management utility Configuration page. . . . .	54
<b>Figure 4-3</b>	Remote Management utility Statistics page. . . . .	58
<b>Figure 4-4</b>	Remote Management utility Diagnostics page. . . . .	59

## 5 Autoloader Operation

<b>Figure 5-1</b>	Location of status LED . . . . .	61
<b>Figure 5-2</b>	Location of cartridge access port . . . . .	62
<b>Figure 5-3</b>	Bar code label placement and write-protect switch location . . .	63
<b>Figure 5-4</b>	Inserting a cartridge into the autoloader . . . . .	65
<b>Figure 5-5</b>	Location of access hole for operating cartridge access port door manually . . . . .	67

## 7 Maintenance

<b>Figure 7-1</b>	Location of tape drive cover plate . . . . .	93
<b>Figure 7-2</b>	Removing the tape drive cover plate to expose the drive cables . . . . .	93
<b>Figure 7-3</b>	Disconnecting the cables from the tape drive . . . . .	94
<b>Figure 7-4</b>	Removing the tape drive . . . . .	94
<b>Figure 7-5</b>	Removing the brackets from the tape drive . . . . .	95
<b>Figure 7-6</b>	LTO full height tape drive with faceplate . . . . .	95
<b>Figure 7-7</b>	Removing the faceplate from the tape drive chassis . . . . .	96
<b>Figure 7-9</b>	Attaching the brackets to a full height tape drive. . . . .	97
<b>Figure 7-10</b>	Half height tape drive installation . . . . .	98
<b>Figure 7-11</b>	Full height tape drive installation . . . . .	98

## 9 Shipping the Autoloader

<b>Figure 9-1</b>	Removing the screws securing the autoloader to the rails . . . .	114
<b>Figure 9-2</b>	Removing the autoloader from the rack . . . . .	114
<b>Figure 9-3</b>	Placing the shipping key. . . . .	115
<b>Figure 9-4</b>	Autoloader in antistatic bag . . . . .	115
<b>Figure 9-5</b>	Installing the first foam packing piece. . . . .	116
<b>Figure 9-6</b>	Foam packing pieces on both sides of autoloader. . . . .	116
<b>Figure 9-8</b>	Autoloader in shipping box with end spacers . . . . .	117
<b>Figure 9-7</b>	Accessory kit in shipping box . . . . .	117
<b>Figure 9-9</b>	Autoloader in shipping box with top foam pads . . . . .	118
<b>Figure 9-10</b>	Accessory kit in shipping box (do not ship accessory kit if returning autoloader for service) . . . . .	118

## B Write Once, Read Many (WORM) Capability

<b>Figure B-1</b>	Ultrium 3 WORM tape cartridge . . . . .	129
-------------------	---	-----



# Tables

## 3 Configuring the Autoloader

<b>Table 3-1</b>	Operator button descriptions . . . . .	23
<b>Table 3-2</b>	Autoloader main menus . . . . .	24
<b>Table 3-3</b>	Autoloader configuration options . . . . .	26
<b>Table 3-4</b>	Emulation modes for the Magnum 1x7 LTO Autoloader . . . . .	31
<b>Table 3-5</b>	Ethernet configuration options . . . . .	35

## 5 Autoloader Operation

<b>Table 5-1</b>	Tape drive cartridge read/write compatibility . . . . .	63
------------------	---	----

## A Specifications

<b>Table A-1</b>	Maximum autoloader storage capacity . . . . .	119
<b>Table A-2</b>	Autoloader dimensions and weight . . . . .	119
<b>Table A-3</b>	LTO Ultrium tape drive transfer rate and capacity . . . . .	120
<b>Table A-4</b>	Environmental specifications . . . . .	123
<b>Table A-5</b>	Acoustic noise limits . . . . .	124
<b>Table A-6</b>	Shock limits . . . . .	124
<b>Table A-7</b>	Shipping weight and dimensions . . . . .	125

## B Write Once, Read Many (WORM) Capability

<b>Table B-1</b>	WORM tape cartridge specifications . . . . .	130
<b>Table B-2</b>	TapeAlert flags associated with the WORM media . . . . .	131
<b>Table B-3</b>	ASC/ASCQ error codes for a Medium Error (SK 3) with WORM media . . . . .	132
<b>Table B-4</b>	ASC/ASCQ error codes for a Data Protect error (SK 7) with WORM media . . . . .	132

## C Error Messages

<b>Table C-1</b>	Autoloader error messages . . . . .	134
------------------	-------------------------------------	-----

# NOTES

## ABOUT THIS MANUAL

This manual describes how to install, configure, operate, maintain, and troubleshoot the Magnum 1x7 LTO Autoloader by Exabyte Corporation. It also provides autoloader specifications.

### WHERE TO LOOK FOR INFORMATION

#### Installation

If you are performing first-time installation:

- ▶ Read [Chapter 1](#) for an overview of the autoloader's features and components.
- ▶ Read [Chapter 2](#) for hardware installation instructions, including obtaining the necessary accessories, installing the autoloader in a rack, installing cartridges, and connecting the autoloader to a host system.
- ▶ Read [Chapter 3](#) for configuration instructions, including how to use the autoloader's operator panel to access and set configuration options.
- ▶ Read [Chapter 4](#) for information about using the autoloader's Remote Management utility to configure the autoloader, view information, and monitor operation across an Ethernet network.

#### Operation

When you are ready to put the autoloader into operation:

- ▶ Read [Chapter 5](#) to learn about inserting and removing cartridges from the autoloader, loading and unloading cartridges in the tape drive, cleaning the tape drive, and performing other basic autoloader operations.
- ▶ Read [Chapter 6](#) to learn about viewing autoloader information including code versions, serial numbers, statistics, sensor readings, and cartridge inventory data.

#### Maintenance, Troubleshooting, and Service

If you need to perform basic autoloader maintenance, troubleshoot problems, or return the autoloader for service:

- ▶ Read [Chapter 7](#) for maintenance information, including instructions for replacing the tape drive, uploading new firmware, and creating diagnostic listings.
- ▶ Read [Chapter 8](#) for troubleshooting tips.
- ▶ Read [Chapter 9](#) for packing and shipping instructions if you need to return the autoloader for service.

## Supplemental Information

- ▶ Read [Appendix A](#) for physical, performance, power, environmental, and safety agency specifications.
- ▶ Read [Appendix B](#) for information about the WORM capability of the LTO-3 tape drive.
- ▶ Read [Appendix C](#) for definitions of autoloader error messages.

## RELATED PUBLICATIONS

For additional information about the autoloader and tape drive, refer to the following publications.

### Magnum 1x7 LTO Autoloader

- ▶ *Magnum 1x7 LTO Autoloader Quick Start Guide*, 1012583
- ▶ *Installing a Magnum 1x7 LTO Autoloader into a Rack*, 1012585
- ▶ *Replacing the Tape Drive in the Magnum 1x7 LTO Autoloader*, 1012586
- ▶ *Magnum 1x7 LTO Autoloader SCSI Reference*, 1012975
- ▶ *Magnum 1x7 LTO Autoloader Product Specification*, 1012985
- ▶ *Exabyte Bar Code Label Specification for LTO Ultrium Cartridges*, 1004080-000

### Ultrium Tape Drives

See the following web sites to locate documentation and support information for IBM LTO Ultrium tape drives.

- ▶ Hewlett-Packard—[www1.hp.com/storage/tapestorage/ultriumdrives.html](http://www1.hp.com/storage/tapestorage/ultriumdrives.html)
- ▶ IBM—[www.storage.ibm.com/tape/lto/oem/index.html](http://www.storage.ibm.com/tape/lto/oem/index.html)

## Standards

- ▶ *Small Computer System Interface - 2 (SCSI-2)*, INCITS 131-1994[R2004]
- ▶ *Information Technology - SCSI-3 Primary Commands (SPC)*, ANSI INCITS 301-1997
- ▶ *Information Technology - SCSI Primary Commands-2 (SPC-2)*, ANSI INCITS 351-2001
- ▶ *SCSI-3 Primary Commands (SPC)*, INCITS 301-1997 [R2002]
- ▶ *Information Technology - SCSI-3 Medium Changer Commands (SMC)*, ANSI INCITS 314-1998
- ▶ *Information Technology - SCSI Parallel Interface-3 (SPI-3)*, ANSI INCITS 336-2000
- ▶ *Information Technology - SCSI Parallel Interface-2 (SPI-2)*, ANSI INCITS 302-1998
- ▶ *Information Technology - SCSI Stream Commands-2 (SSC-2)*, ANSI INCITS 380-2003

- ▶ *TapeAlert Specification*, NCITS T10/02-142R0, Version 3.0, March 2002
- ▶ IEC 60297 Rack Standards

For general information, go to [www.t10.org](http://www.t10.org)

## CONVENTIONS USED IN THIS MANUAL

This manual uses the following conventions:

**Note:** Notes provide additional information or suggestions about the topic or procedure being discussed.

---

**!** **Important** Read text marked by the “Important” icon for information that will help you complete a procedure or avoid extra steps.

---



### **Caution**

Read text marked by the “CAUTION” icon for information you must know to avoid damaging the autoloader, the tape drive, or losing data.

---

---



### **Warning**

Read text marked by the “WARNING” icon for information you must know to avoid personal injury.

---

## NOTES



# PRODUCT OVERVIEW

Congratulations on selecting the Magnum 1x7 LTO Autoloader by Exabyte Corporation. Your new autoloader is equipped with either an LTO Ultrium 2 (LTO-2) or Ultrium 3 (LTO-3) tape drive and features Exabyte's patented, award-winning ExaBiotics™. The autoloader provides unattended data storage, archiving, backup, and retrieval for small PC workgroups to multi-server networks.

This chapter provides an overview of the autoloader's features and components.



## AUTOLOADER FEATURES

The Magnum 1x7 LTO Autoloader includes the following features:

- ▶ **Storage for up to 7 data cartridges.** Up to 7 data cartridges are stored in the autoloader on a rotating cartridge carousel that automatically positions the cartridges at the tape drive or at the cartridge access port for removal.
- ▶ **One LTO Ultrium tape drive.** The autoloader contains one high-performance, high-capacity LTO-2 or LTO-3 tape drive. The tape drive is easily removed from the autoloader if it ever needs to be replaced.
- ▶ **Cartridge access port.** A cartridge access port, located on the front of the autoloader, allows easy insertion and removal of cartridges. Cartridges can be removed from the autoloader with the power on or off.

- ▶ **Bar code scanner.** A bar code scanner allows the autoloader to maintain an inventory of its cartridges.
- ▶ **Operator panel with LCD display.** The operator panel allows you to monitor autoloader operations and select configuration options.
- ▶ **Low-voltage differential (LVD) SCSI interface.** The autoloader has an LVD SCSI interface.
- ▶ **Ethernet port for connection to a 10/100BaseT Ethernet network.** When used with the Remote Management utility, you can connect the autoloader to an Ethernet network for remote monitoring, upgrading autoloader firmware, and creating diagnostic listings.
- ▶ **Remote Management Utility.** The autoloader's Remote Management utility allows you to use a standard web browser to set configuration options, view autoloader information, and monitor autoloader operations over an Ethernet network.
- ▶ **Rack-mount hardware.** The autoloader is designed to mount in a standard 19-inch rack using just 2 units (2U) of rack space. Rack-mounting hardware is included with the autoloader.

## AUTOLOADER COMPONENTS

The following sections describe the autoloader's front panel, back panel, and internal components.

### FRONT PANEL COMPONENTS

Figure 1-1 shows the autoloader's front panel components.

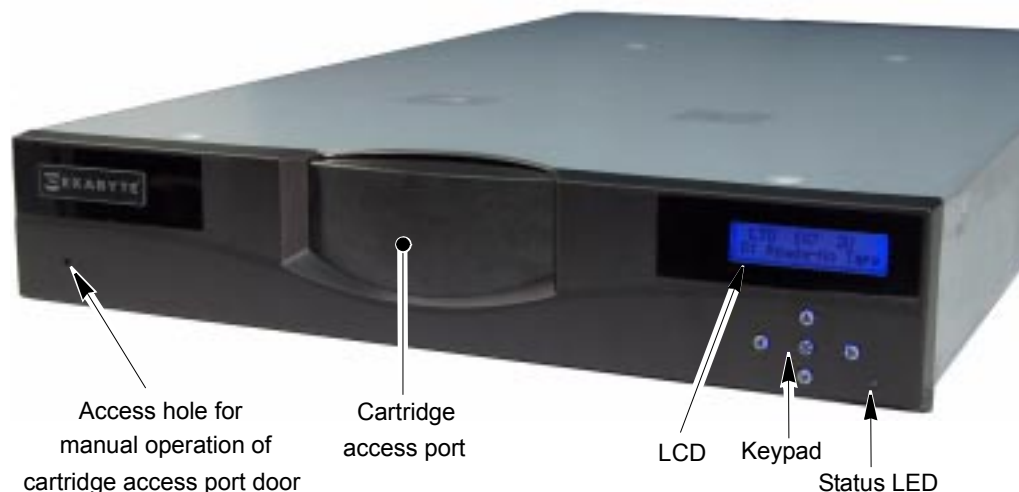

**Figure 1-1** Magnum 1x7 LTO Autoloader front panel components



**Operator Panel (LCD and Keypad)** The operator panel includes a five-button keypad and a two-line, 32-character liquid crystal display (LCD). You can use the operator panel to:

- ▶ Set or change autoloader configuration options
- ▶ Issue commands to the autoloader
- ▶ View autoloader status and information
- ▶ Run demonstration programs and test autoloader functions
- ▶ Reset the autoloader

**Cartridge Access Port** The cartridge access port allows you to insert or remove cartridges from the autoloader. The cartridge access port door is motor-driven, under control of the autoloader. To prevent unauthorized use of the cartridge access port, operator panel menus can be password protected or access can be prevented through the application.

In the event of a power failure, you can manually open the cartridge access port door to remove cartridges. A hole in the front of the faceplate provides access to a gear shaft attached to the door. You can use a small screwdriver to turn the gear shaft and open the door.

**Status LED** The status LED indicates autoloader activity as shown in the following table. See [Figure 1-1](#) for the location of the status LED.

LED	Color	Status
	Off (no color)	The autoloader is idle
	Green	The autoloader is performing a mechanical operation
	Amber	The autoloader encountered a hardware error See <a href="#">Appendix C, Error Messages</a>

## BACK PANEL COMPONENTS

[Figure 1-2](#) shows the back panel components of the autoloader.

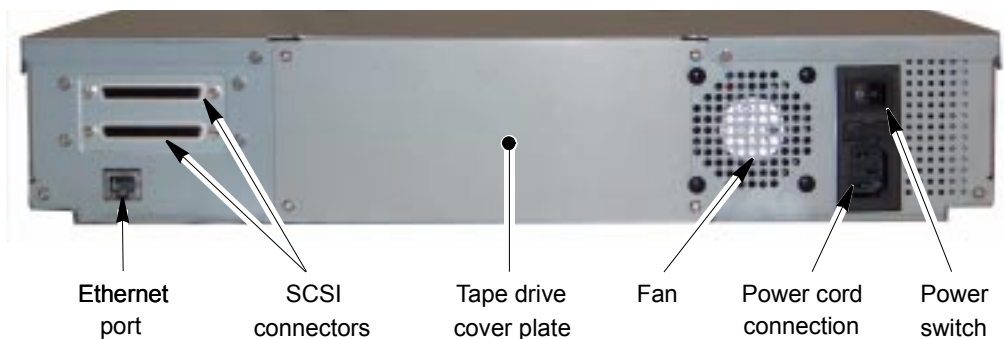

**Figure 1-2** *Magnum 1x7 LTO Autoloader back panel components*

**SCSI Connectors** The autoloader has two wide SCSI connectors for connecting the autoloader and tape drive to a single SCSI bus. The connectors can accommodate either of the following:

- ▶ SCSI connector—An Ultra 160 SCSI connector (minimum rating)
- ▶ Terminator—An Ultra 3 Active SCSI terminator (minimum rating)

**Tape Drive Cover Plate** The tape drive cover plate allows access to the tape drive for easy replacement, if necessary.

**Ethernet Port** The Ethernet port allows you to connect the autoloader to a 10/100BaseT Ethernet network. You can use the Ethernet connection to perform the following activities:

- ▶ Upgrade the autoloader's firmware
- ▶ Upload diagnostic information from the autoloader using FTP
- ▶ Monitor autoloader operations using its built-in Remote Management software

**Fan** The system fan provides cooling for the autoloader and the tape drive.

**Power Cord Connection** The power cord connection provides AC power to the autoloader and the tape drive.

**Power Switch** The power switch allows you to turn power on and off for the autoloader and the enclosed tape drive.

## INTERNAL COMPONENTS

Figure 1-3 shows the autoloader's internal components.



**Figure 1-3** *Magnum 1x7 LTO Autoloader internal components*

**Tape Drive** The enclosed LTO Ultrium tape drive is mounted at the back of the autoloader.

**Bar Code Scanner** The bar code scanner is located inside the cartridge carousel. The scanner enables the autoloader to read information from bar code labels on the cartridges into its cartridge inventory. An autoloader application can use the inventory information to locate and move specific cartridges.

**Cartridge Carousel** The autoloader's cartridge carousel holds up to seven data cartridges. The motor-driven carousel positions the cartridges in front of the tape drive and cartridge access port. The cartridges are installed in cartridge cells mounted on the carousel that ensure each cartridge is properly aligned to be inserted into the tape drive.

**Cartridge Loader** The cartridge loader moves cartridges between the cartridge cells and the tape drive. When a cartridge cell is positioned in front of the tape drive, the loader pushes the cartridge out of the cell and into the tape drive. When the cartridge is ejected from the tape drive, the cartridge loader pulls the cartridge back into the cell.

## NOTES

# 2

## INSTALLING THE AUTOLOADER

This chapter describes how to install the autoloader. Depending on your requirements, installation will involve most or all of the following steps:

- ▶ Completing the unpacking process
- ▶ Obtaining accessories and equipment
- ▶ Preparing for installation
- ▶ Installing the autoloader in a rack
- ▶ Connecting the autoloader to SCSI
- ▶ Connecting the autoloader to Ethernet (optional)
- ▶ Powering on the autoloader
- ▶ Verifying the hardware installation

## COMPLETING THE UNPACKING PROCESS

**! Important** After unpacking the autoloader, save all the original packing materials in case you need to ship or move the autoloader later.

The robotic cartridge loader inside the autoloader is secured with a small metal shipping key to keep the loader from moving during shipping. Before operating the autoloader, you must remove this shipping key. To remove the shipping key:

1. Remove the adhesive label securing the shipping key to the autoloader (see [Figure 2-1](#)).



**Figure 2-1** Label over shipping key

2. Lift the shipping key up and out of the slot in the top of the autoloader (see [Figure 2-2](#)).

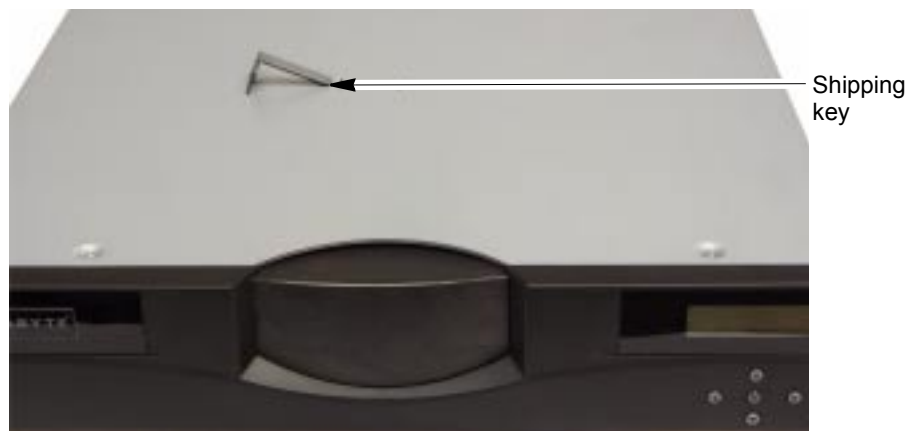

**Figure 2-2** Removing the shipping key



3. Save the shipping key with the autoloader's packing materials in case you need to move or ship the autoloader later.



## OBTAINING ACCESSORIES AND EQUIPMENT

Make sure that you have all the accessories and equipment for autoloader installation and operation, as indicated in the following table. You can purchase most of these items from your supplier or Exabyte (see [Contacting Exabyte on page iii](#)).

**! Important** Both LTO-2 and LTO-3 SCSI tape drives are Ultra 160 SCSI devices and require a minimum Ultra 160 non-RAID SCSI host bus adapter card, Ultra 160 rated SCSI cabling, and an Ultra 3 Active SCSI terminator.

Accessories and Equipment	
<b>Rack-Mount Hardware</b>	The autoloader is designed to be installed in a standard 19-inch rack. Rack-mount hardware is provided with the autoloader.
<b>SCSI Cable</b>	<div style="display: flex; justify-content: space-between;"> <div style="width: 60%;"> <p>One high-density (HD), wide (68-pin), 2-meter LVD SCSI cable is provided with the autoloader.</p> <p><b>Note:</b> If your SCSI controller has a 68-pin very high-density (VHDCI) connector, you will need to obtain a VHDCI-to-HD SCSI cable.</p> </div> <div style="width: 35%;"> <p><b>HD Connector</b></p>  <p><b>VHDCI Connector</b></p>  </div> </div> <p>If you want to use your own SCSI cable(s), follow these guidelines:</p> <ul style="list-style-type: none"> <li>Use high-density, wide (68-pin) Ultra 160 SCSI cables that conform to SCSI-3 specifications. To comply with the regulations and standards listed in <a href="#">Appendix A</a>, all SCSI cables used with the autoloader must be properly shielded.</li> <li>The maximum allowable length of an LVD SCSI bus is 12 meters (39 feet) if you have more than two devices on the bus.</li> </ul>
<b>SCSI Bus Terminator</b>	<p>One wide Ultra 3 Active SCSI terminator is provided with the autoloader. If you want to use your own terminator, use a high-quality Ultra 3 rated Active SCSI terminator. An appropriate terminator is stamped with Ultra 3 or LVD 160 and "Active Negation."</p> <p><b>Important!</b> Both LTO-2 and LTO-3 SCSI tape drives require an Ultra 3 or LVD 160 terminator to function properly on the SCSI bus. An inadequate terminator will result in various SCSI bus issues, including bus hangs and Read/Write failures.</p>
<b>Ethernet Cable</b>	<p>One Ethernet cable is provided. You can use this cable to connect the autoloader to an Ethernet network for remote monitoring, firmware upgrades, and diagnostics.</p> <ul style="list-style-type: none"> <li>If you want to provide your own Ethernet cable, use a shielded Category 5 (10/100BaseT connection) data-grade cable or similar Category 5 cable that is compliant with EIA/TIA 568. The autoloader's Ethernet port connector is a pin-through-hole RJ-45 shielded connector.</li> <li>To comply with the regulations and standards listed in <a href="#">Appendix A</a>, all Ethernet cables used with the autoloader must be properly shielded.</li> </ul>
<b>Power Cord</b>	Two power cords are provided with the autoloader: one for use in the US and Canada and one for use in Europe. If you plan to use the autoloader outside of these locations, refer to <a href="#">page 122</a> for power cord requirements.

Accessories and Equipment (continued)				
<b>Bar code labels</b>	Sample bar code labels for the cartridges are included with the autoloader. If you want to prepare your own labels, refer to the <i>Exabyte Bar Code Label Specification for LTO Ultrium Cartridges</i> on the product CD.			
<b>Cartridges</b>	Use only data cartridges and cleaning cartridges designed specifically for LTO Ultrium tape drives. The LTO Ultrium tape drives support the following LTO Ultrium cartridges.			
	<b>Tape Drive</b>	<b>Supported Cartridges</b>	<b>Color</b>	<b>Native Capacity</b>
	<b>LTO-3</b>	Ultrium 3	Slate Blue	400 GB
		Ultrium 2	Purple	200 GB
		Ultrium 1 (READ only)	Black	100 GB
		WORM (see <a href="#">Appendix B</a> )	Two-toned	400 GB
	<b>LTO-2</b>	Ultrium 2	Purple	200 GB
Ultrium 1		Black	100 GB	
<ul style="list-style-type: none"> <li>▪ For maximum capacity, use Ultrium 3 data cartridges with Ultrium 3 (LTO-3) tape drives and Ultrium 2 data cartridges with Ultrium 2 (LTO-2) tape drives.</li> <li>▪ Use only LTO Ultrium cleaning cartridges.</li> </ul>				
<b>Tools</b>	You need to obtain these tools.			
	<b>Tool</b>	<b>Used for</b>		
	Phillips screwdriver—#2 Phillips screwdriver—#1	<a href="#">Installing the Autoloader in a Rack</a> <a href="#">Replacing the Tape Drive</a>		
	Phillips screwdriver—#0	<a href="#">Removing Cartridges Without Power</a>		
	Small, flat-blade screwdriver	<a href="#">Replacing the Tape Drive</a>		
	Level	<a href="#">Installing the Autoloader in a Rack</a>		
	Tape measure	<a href="#">Installing the Autoloader in a Rack</a>		

## PREPARING FOR INSTALLATION

Before you begin installing the autoloader, do the following:

- ▶ **Make sure that the SCSI host bus adapter card installed in the host computer, any necessary device drivers, and your backup software are compatible with the autoloader.** Make certain that an Ultra 160 SCSI host bus adapter (HBA) and any necessary drivers installed in the host computer are compatible with the tape drive(s).

---

**! Important** Both LTO-2 and LTO-3 tape drive are Ultra 160 SCSI devices and require a minimum Ultra 160 non-RAID SCSI host bus adapter card.

---

- ▶ For optimum performance, use an Ultra160 SCSI host bus adapter. Compatibility information is available from [www.exabyte.com/compatibility](http://www.exabyte.com/compatibility).
- ▶ If your software has not yet been certified for the Magnum 1x7 LTO Autoloader, you can use one of the autoloader’s emulation modes (see [page 31](#)).
- ▶ You can install the software on the host computer before or after autoloader installation. However, if you install the software first, you may need to reconfigure it for use with the autoloader after autoloader installation is complete.
- ▶ **Locate an appropriate area for the autoloader.** Select a location that has adequate clearance for ventilation, minimal dust and debris, and an appropriate power source. The autoloader is designed to operate in a standard 19-inch rack. To provide adequate air flow, a ventilated rack is recommended.

The autoloader must be operated in the horizontal position. Do not place the autoloader on its side, and do not place objects on top of the library.

- ▶ **Ensure that the work area is free from conditions that could cause electrostatic discharge (ESD).** Discharge static electricity from your body by touching a known grounded surface, such as a computer’s metal chassis.



**Warning**

Before performing any installation or maintenance procedures, be sure that the autoloader’s power switch is off and that the power cord is disconnected from the autoloader and the outlet.



**Warnung**

Vor der Ausführung von Installations- oder Wartungsarbeiten ist darauf zu achten, daß der Autoloader-Netzschalter auf “Aus” gestellt ist und daß das Anschlußkabel vom Autoloader und der Steckdose entfernt ist.



**Advertencia**

Antes de realizar cualquier procedimiento de instalación o de mantenimiento, comprobar que el interruptor de alimentación de la biblioteca está apagado y que el cable de alimentación no está enchufado ni a la biblioteca ni a la toma de corriente.

## INSTALLING THE AUTOLOADER IN A RACK

The autoloader is designed to be installed in a standard 19-inch rack, using 2 units (2U) of rack space. Rack-mounting hardware is included with the autoloader. The rack-mount kit includes the following items:

18 – M5 x 12 Crest Cup™ screws (black) (includes two spare screws)	2 – sets of side support rails: <ul style="list-style-type: none"> <li>▪ left-side front and back rails</li> <li>▪ right-side front and back rails</li> </ul>
2 – M3 x 8 Crest Cup screws (silver)	
8 – washers	

To install the library in a rack, you must obtain these tools:

#2 Phillips screwdriver	Level	Tape measure
-------------------------	-------	--------------

## ASSEMBLING THE RAILS

1. Measure the depth of your rack—Using a tape measure, measure the *inside* distance from the front mounting holes of your rack to the back mounting holes. See [Figure 2-5](#), distance (E).
2. Position the front and back sections of the left-side rail as shown in [Figure 2-3](#), with the front rail section on *top* of the back rail section. Spread the sections to the distance you measured in step 1.
3. Assemble the left rail using four M5 screws. Keep the screws loose so that you can adjust the length of the assembled rail, if necessary.

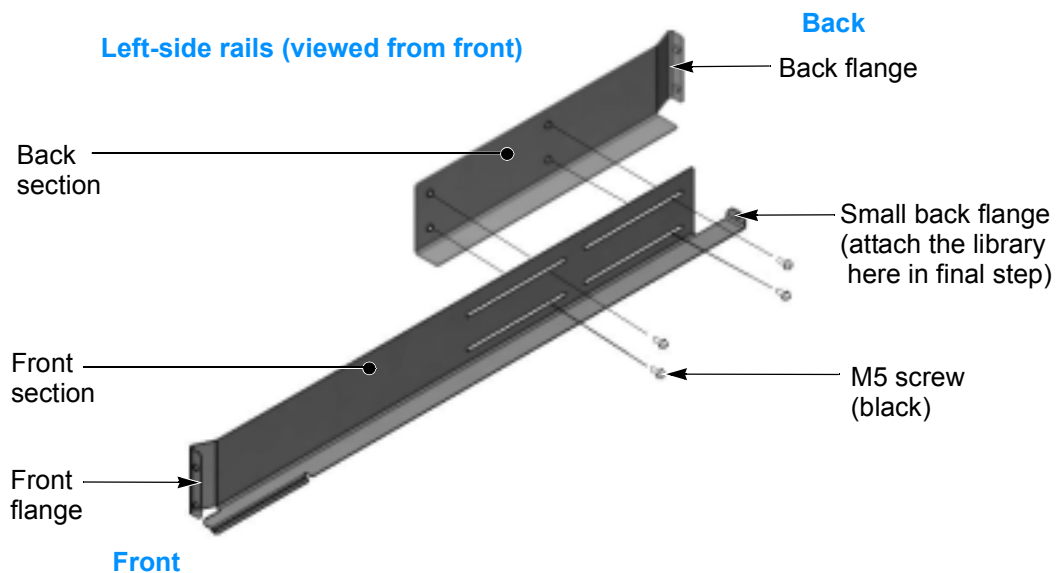

**Figure 2-3** Assembling the left-side rail

- Assemble the right-side rail in the same way.

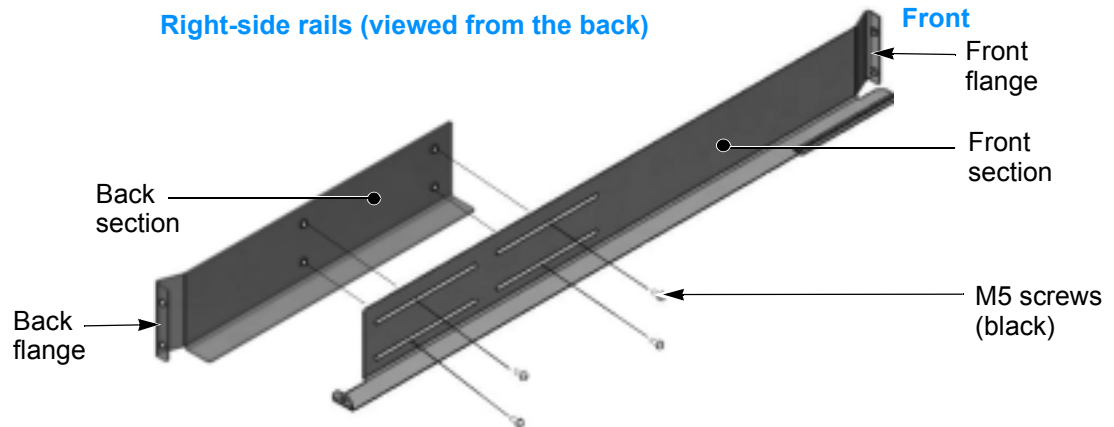

**Figure 2-4** Assembling the right-side rail

## ATTACHING THE RAILS TO THE RACK

- Left side rail assembly**—Position the left-side rail assembly in the rack so that the front flange is *behind* the front screw holes in the rack.

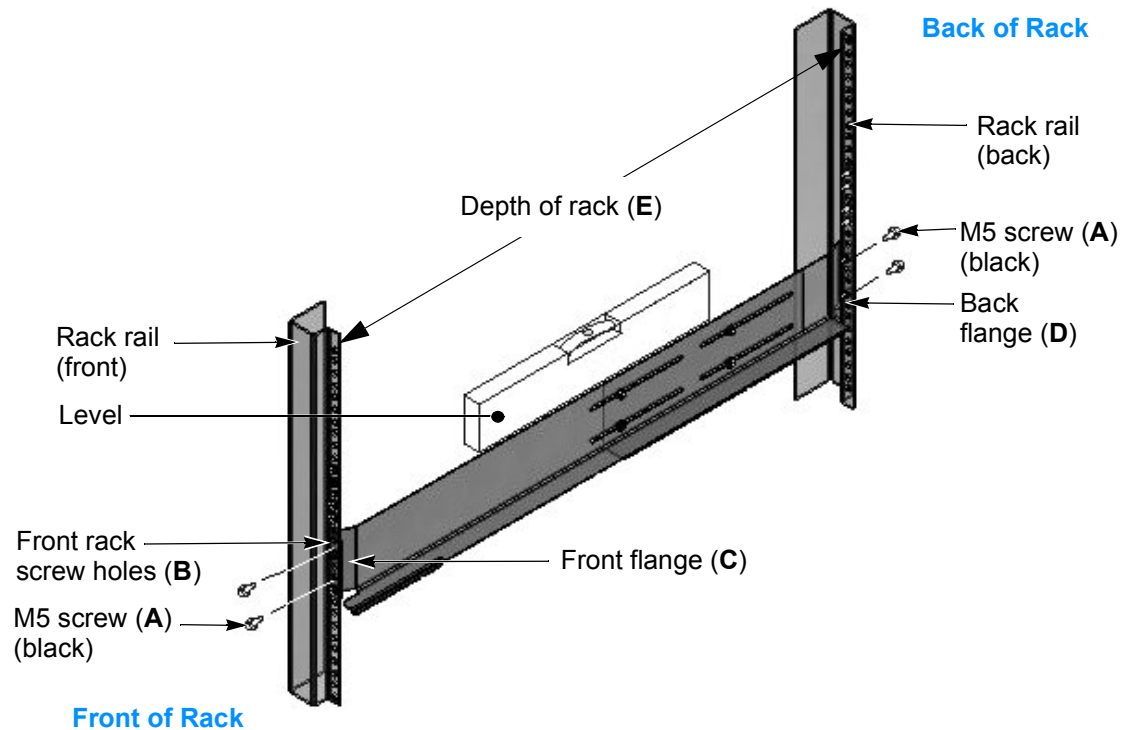

**Figure 2-5** Attaching the left-side rail to the rack

- Front of rack**—Insert an M5 screw (A) through one of the front rack screw holes (B) and engage the pem nut in the rail flange (C). If your rack has square mounting holes or the holes are much larger than the screws provided in the kit, use a washer. Finger-tighten the screw.

Insert an M5 screw (A) through a second screw hole (B) and engage the pem nut on the second screw hole in the rail flange (C). If necessary, use a washer. Finger-tighten the screw.

3. Adjust the length of the rail assembly as necessary to fit the depth of the rack (E).
4. **Back of rack**—Make sure the rail assembly is level, then use M5 screws (A) to attach the back flange (D) of the rail to the *inside* of the rack, using the same procedure as step 2. If your rack has square mounting holes or the holes are much larger than the screws provided in the kit, use a washer. Finger-tighten the screws.
5. Using a #2 Phillips screwdriver, tighten the screws securing the rails to the front and back of the rack.
6. Using a #2 Phillips screwdriver, tighten the four screws holding the rail assembly together.
7. **Right side rail assembly**—Repeat steps 1 through 6 for the right-side rail assembly. Make sure that the right rail assembly is at the same level as the left rail assembly.

## ATTACHING THE AUTOLOADER TO THE RAILS

To attach the autoloader to the rails:

1. From the front of the rack, place the autoloader onto the shelf created by the rails (see [Figure 2-6](#)).



**Figure 2-6** *Placing the autoloader on the rails*

2. Slide the autoloader all the way back until it makes contact with the small flanges near the back of the rails (see [Figure 2-7](#)).

3. From the back of the rack, attach the autoloader to the rails by inserting an M3 screw into each of the small flanges (see [Figure 2-7](#)). Tighten the screws using a #1 Phillips screwdriver.

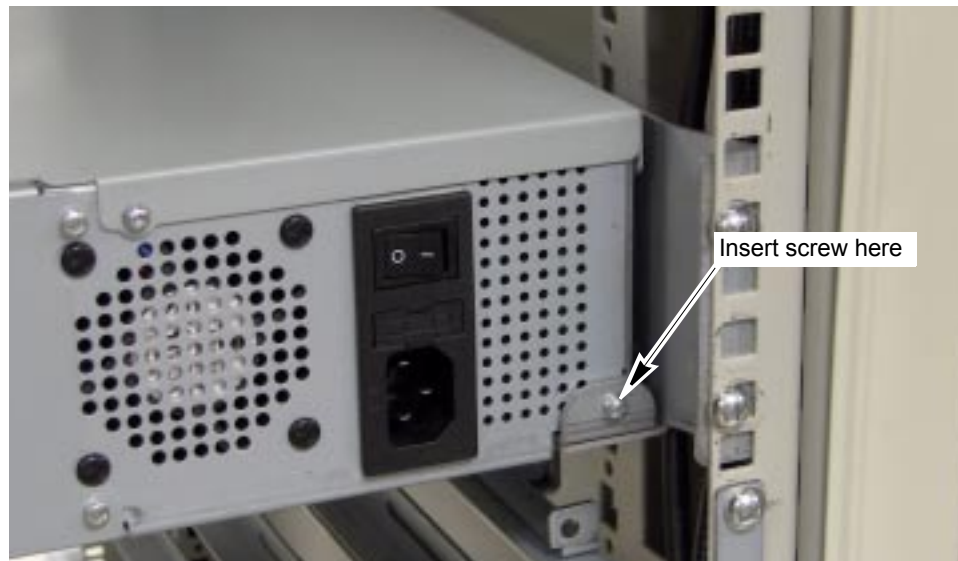

**Figure 2-7** Attaching the autoloader to the rails at the back of the rack

## CONNECTING THE AUTOLOADER TO SCSI

This section provides guidelines for connecting the autoloader to a host system via SCSI. The autoloader includes two SCSI devices: the autoloader itself and the tape drive. The two devices share one set of wide, low-voltage differential (LVD) SCSI connectors for connection to a SCSI bus. Up to 16 devices can be connected to a wide LVD SCSI bus.

---

**! Important** Both LTO-2 and LTO-3 SCSI tape drives are Ultra 160 SCSI devices and require a minimum Ultra 160 non-RAID SCSI host bus adapter card, Ultra 160 rated SCSI cabling, and an Ultra 3 Active SCSI terminator.

---



---

**! Caution** Do not connect the autoloader to a high-voltage differential (HVD) SCSI bus. Doing so may damage the autoloader, tape drive, or other devices on the bus.

---

### GUIDELINES FOR CONNECTING TO SCSI

Keep these guidelines in mind as you plan your SCSI connections:

- ▶ **Do not connect to an inadequate host bus adapter.**

---

**! Important** Both LTO-2 and LTO-3 SCSI tape drives are Ultra 160 SCSI devices and require a minimum Ultra 160 non-RAID SCSI host bus adapter card.

---

- ▶ **Do not connect single-ended SCSI devices.** Although single-ended SCSI is compatible with the autoloader's LVD SCSI interface, Exabyte does not support connecting single-ended devices to the SCSI bus attached to the autoloader.
- ▶ **Do not connect the autoloader to a RAID controller.** The autoloader will not operate if it is connected to a RAID controller.
- ▶ **Do not exceed SCSI bus length restrictions.** The maximum allowable length of an LVD SCSI bus is 12 meters (39 feet) if you have more than two devices on the bus. Make sure the SCSI bus attached to the autoloader does not exceed this length. To determine the length of the bus:
  - a. Add together the lengths of all external SCSI cables on the bus.
  - b. Add 64 centimeters (25.2 inches) for the internal cable length used by the autoloader and its tape drive.
  - c. Add the internal cable lengths for any other SCSI devices on the bus.
- ▶ **Make sure the SCSI bus is properly terminated.** You must install a terminator on the device at the physical end of the SCSI bus.

---

**! Important** Both LTO-2 and LTO-3 SCSI tape drives require an Ultra 3 or LVD 160 terminator to function properly on the SCSI bus. An inadequate terminator will result in various SCSI bus issues, including bus hangs and Read/Write failures.

See [Tape Drive Operation](#) (Tape drive fails with sporadic errors) on [page 107](#) for failure symptoms associated with using the wrong terminator.

---

- ▶ Autoloader is last device on SCSI bus—If the autoloader terminates the SCSI bus, you must install the required terminator on one of the autoloader's SCSI connectors.
- ▶ Autoloader is not last device on SCSI bus—If there are additional devices on the SCSI bus, ensure that only the device at the physical end of the bus is terminated.

## MAKING THE SCSI CONNECTIONS

To connect the autoloader to SCSI:

1. Make sure that the autoloader is powered off.
2. Power off the host computer and any peripheral devices on the SCSI bus.



3. Connect a SCSI cable to the host computer and to one of the autoloader's SCSI connectors. [Figure 2-8](#) shows the location of the autoloader's SCSI connectors.



**Figure 2-8** SCSI connectors on the back of the autoloader

---

**! Important** Do not over-tighten the SCSI cable jack screws.

---

4. If the autoloader is the last device on the SCSI bus, install a terminator on the unused SCSI connector.

---

**! Important** Both LTO-2 and LTO-3 SCSI tape drives require an Ultra 3 or LVD 160 terminator to function properly on the SCSI bus. An inadequate terminator will result in various SCSI bus issues, including bus hangs and Read/Write failures.

See [Tape Drive Operation](#) (Tape drive fails with sporadic errors) on [page 107](#) for failure symptoms associated with using the wrong terminator.

---

- ▶ **Daisy-chaining**—If the autoloader is not the last device on the bus, connect another SCSI cable from the autoloader's SCSI connector to the next device on the bus.
- ▶ **Bus termination**—If there are additional devices on the SCSI bus, ensure that only the device at the physical end of the bus is terminated.

Figure 2-9 shows how to connect the autoloader as the last device on a SCSI bus.

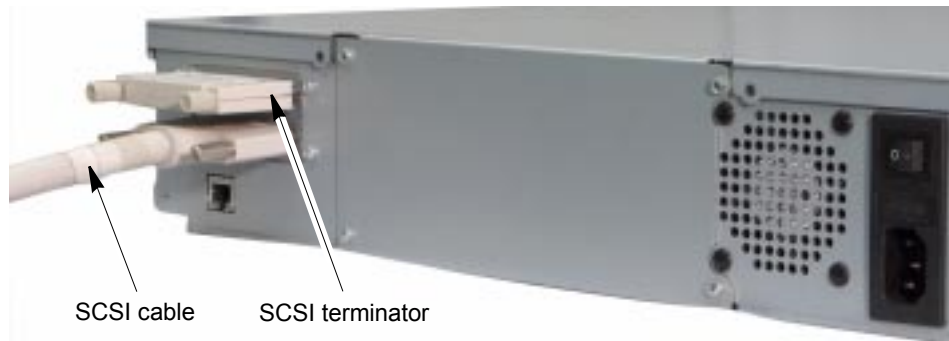

**Figure 2-9** Connecting the autoloader as the last device on the SCSI bus

5. Power on all of the peripheral devices on the SCSI bus.
6. Power on the autoloader as described on [page 19](#).

## CONNECTING THE AUTOLOADER TO ETHERNET

The autoloader's Remote Management utility (described in [Chapter 4](#)) allows you to remotely monitor operations when the autoloader is connected to an Ethernet network. You can also create diagnostic listings and upgrade autoloader firmware. For information about upgrading firmware and creating diagnostic listings, see [page 100](#).

To connect the autoloader to Ethernet using the provided cable:

1. Insert one end of the cable into the autoloader's Ethernet port until you hear it snap into place. The Ethernet port is located on the back of the autoloader, as shown in [Figure 2-10](#).



**Figure 2-10** Connecting the autoloader to an Ethernet network

2. Connect the other end of the cable to the network or directly to the server you plan to use to run the autoloader's Remote Management utility or upload firmware.

When you perform autoloader configuration, you will configure the autoloader's Ethernet interface (see [page 35](#)).

## POWERING ON THE AUTOLOADER

To power on the autoloader:

1. Make sure that the power switch on the back of the autoloader is off (press the **0**).



**Figure 2-11** Location of the power switch and power connector

2. Connect the female end of the power cord to the power connector on the back of the autoloader.

---

**! Important** Two power cords are shipped with the autoloader: One for use in the US and Canada, and one for use in Europe. Use the correct power cord for your location. See [page 122](#) for power cord requirements for other locations.

---

3. Plug the male end of the power cord into the power source.
4. Push the power switch on the back of the autoloader to the on position (press the **I**). The autoloader performs its power-on sequence. During this time, the following activities occur:
  - ▶ The cooling fan begins to operate.
  - ▶ The LCD illuminates.
  - ▶ The tape drive and autoloader perform self-tests.
  - ▶ The autoloader calibrates the positions of the cartridge cells.
  - ▶ The autoloader checks each cartridge cell to determine if a cartridge is present and updates the cartridge inventory.
5. If necessary, set the SCSI IDs for the autoloader and the tape drive. You can use the default IDs or change them if they conflict with other devices on the SCSI bus. See [page 29](#) for instructions.

**6.** Power on the host computer system.

---

**! Important** Do not power on the host computer system immediately after powering on the autoloader. After you press the autoloader's power switch, there is a short delay before the tape drive is on-line.

---

## VERIFYING THE HARDWARE INSTALLATION

After the autoloader powers on, the LCD displays the Home screen. As shown in the example below, the first line of the Home screen displays the product name and the second line shows status for the autoloader and tape drive.

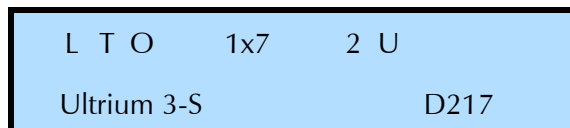

The screenshot shows a light blue rectangular area with a black border. The first line contains the text "L T O 1x7 2 U". The second line contains the text "Ultrium 3-S D217".

If the autoloader powered on as described, continue with configuration in [Chapter 3](#).

If the autoloader did not power on as described, check the following:

- ▶ Is the power switch on?
- ▶ Is the power cord inserted correctly?
- ▶ Is the SCSI bus terminated?
- ▶ Are the devices on the SCSI bus attached to the autoloader all LVD?
- ▶ Is the SCSI cable firmly connected to the autoloader and host computer or other devices on the bus?
- ▶ Is the host computer system turned on?
- ▶ Is there an error message displayed on the autoloader's LCD? (see [Appendix C](#) for descriptions of LCD error messages.)
- ▶ For additional tips, see [Chapter 8, "Troubleshooting"](#).

# 3

## CONFIGURING THE AUTOLOADER

After installing the autoloader hardware, you are ready to set configuration options. This chapter describes how to:

- ▶ Access configuration options
- ▶ Set configuration options
- ▶ Check the setup

### ACCESSING CONFIGURATION OPTIONS

With the Magnum 1x7 LTO Autoloader you can use the operator panel or the autoloader's web-based Remote Management utility to access configuration options. If you plan to use the Remote Management utility, refer to [Chapter 4](#).

### USING THE OPERATOR PANEL

The autoloader's operator panel includes a two-line LCD and keypad (see [Figure 3-1](#)) that allow you to interactively control autoloader operations. Using the operator panel, you can set autoloader options, check operating statistics, and diagnose errors.

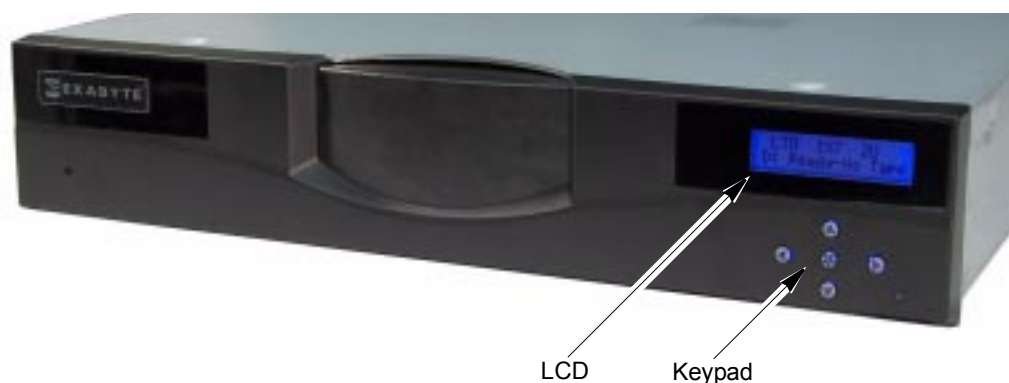

**Figure 3-1** Autoloader LCD and keypad

## Viewing the Home Screen

During normal operation, the Home screen appears on the LCD (see the example below). You can use this screen to monitor autoloader status.

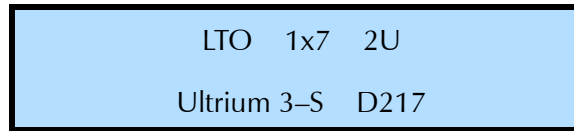

▶ **Tape Drive Status Messages**—Some examples of tape drive status messages (indicated by D:) are:

- |                 |                    |              |
|-----------------|--------------------|--------------|
| ▶ Ready         | ▶ Needs Cleaning   | ▶ Erasing    |
| ▶ Ready-No Tape | ▶ Cleaning         | ▶ Formatting |
| ▶ Tape Ejected  | ▶ Replace Cln Cart | ▶ Recovering |
| ▶ Loading       | ▶ Writing          | ▶ Locating   |
| ▶ Unloading     | ▶ Reading          | ▶ Rewinding  |

▶ **Hardware Error Messages**—If a hardware error occurs, an error message appears on the Home screen. Refer to [Chapter 8](#) and [Appendix C](#) for help in diagnosing and correcting errors. You must correct the error before operation can continue.

▶ **To return to the Home screen**—If a menu is currently displayed on the LCD and you want to view the Home screen, press this button (▲) to return to the Home screen.

**Note:** From any menu, the LCD automatically returns to the Home screen after two minutes of inactivity (no buttons being pressed).

## Using the Operator Panel Buttons

[Figure 3-2](#) shows the operator panel buttons. Use the buttons to navigate through the autoloader's configuration, operation, and information menus. As shown in [Figure 3-3 on page 25](#), the autoloader's menus are organized in a tree structure consisting of four main menus with sub-menus and selections. The operator panel buttons allow you to move up and down between menu levels, view choices within menus, and make selections.

When the edges of a button are lit, the button is a valid choice for the information currently displayed on the LCD. When the edges are dark, the button is not a valid choice and performs no action.

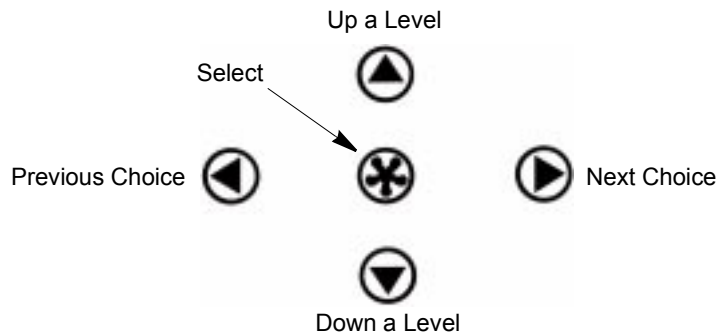





**Figure 3-2** Operator panel buttons





[Table 3-1](#) describes the actions performed by the operator panel buttons.

**Table 3-1** Operator button descriptions

Button	Description
	<p><b>Next Choice (right arrow)</b> – Press this button to move forward through the selections in a menu.</p> <p><b>Note:</b> If you are entering a password, press this button to move forward through the available values at a character position. Press and hold the button to move rapidly through the available values.</p>
	<p><b>Previous Choice (left arrow)</b> – Press this button to move backward through the selections in a menu.</p> <p><b>Note:</b> If you are entering a password, press this button to move backward through the available values at a character position. Press and hold the button to move rapidly through the available values.</p>
	<p><b>Down a Level (down arrow)</b> – Press this button to move down into a lower level of menus. For example, if the screen is displaying one of the main menus, press this button to view that menu's sub-menus.</p> <p><b>Note:</b> If you are entering a password, press this button to move forward through the character positions of the password.</p>
	<p><b>Up a Level (up arrow)</b> – Press this button to return to the previous level of menus. At the top level of menus, pressing this button returns to the Home screen.</p> <p>If you are making selections within a menu and change your mind about a selection, press this button to return to the previous screen without enacting the change.</p> <p><b>Note.</b> If you are entering a password, press this button to move backward through the character positions of the password.</p>
	<p><b>Select</b> – Press this button to cause an operation displayed on the LCD to be enacted. For example, if you are changing a SCSI ID, pressing this button causes the new value you have entered to take effect.</p> <p>As confirmation, after you press the Select button, the original screen for changing the value reappears and displays the new value.</p>

## OVERVIEW OF AUTOLOADER MENUS

When the Home screen is displayed on the LCD, press , , , or  to access the autoloader's main menus.

Press  or  to loop through the main menus, and press  to enter one of the menus and see its sub-menus. Once you are within a menu, press  or  to loop through the choices in that menu.

[Table 3-2](#) provides an overview of the autoloader's main menus. [Figure 3-3](#) shows the organization of the menus.

**Table 3-2** Autoloader main menus

Menu	Description
<b>Select a Command</b>	Allows you to issue commands for basic autoloader operations, including: <ul style="list-style-type: none"> <li>▪ inserting and removing cartridges</li> <li>▪ loading and unloading cartridges from the tape drive</li> <li>▪ updating the inventory</li> <li>▪ cleaning the tape drive</li> </ul>
<b>View a Status</b>	Allows you to view: <ul style="list-style-type: none"> <li>▪ an event log for the autoloader</li> <li>▪ tape drive information (firmware, serial number, and SCSI ID)</li> <li>▪ library information (firmware, serial number, SCSI ID, loads, moves, ethernet settings, and the operation mode)</li> <li>▪ individual cartridge cell statistics (puts and picks)</li> <li>▪ bar code label information</li> <li>▪ tape drive status (see <a href="#">“Viewing the Home Screen” on page 22</a>)</li> <li>▪ sensor readings (door, eject, and cell sensors, library temperature, system fan, and power supply fan)</li> </ul>
<b>Change a Configuration</b>	Allows you to view and change the: <ul style="list-style-type: none"> <li>▪ SCSI IDs</li> <li>▪ emulation mode</li> <li>▪ autoclean settings</li> <li>▪ operating mode</li> <li>▪ Ethernet settings</li> </ul> Also allows you to: <ul style="list-style-type: none"> <li>▪ set up a password to restrict access to the operator panel menus</li> <li>▪ restore the autoloader configuration settings to their default values</li> </ul>
<b>Perform a Diagnostic</b>	Allows you to: <ul style="list-style-type: none"> <li>▪ run a hardware self test</li> <li>▪ run system demos</li> <li>▪ reset the autoloader</li> </ul>



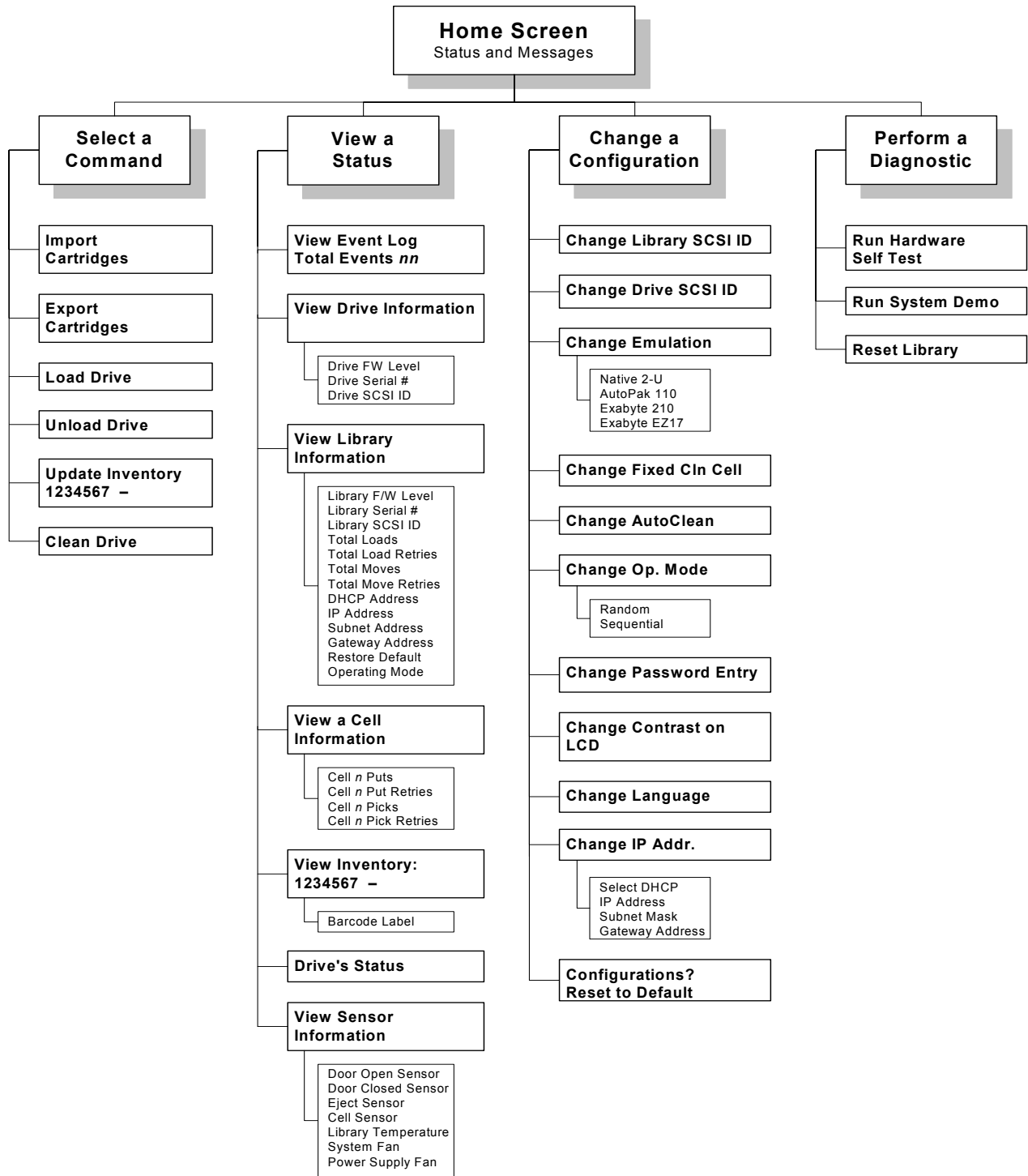

Figure 3-3 Autoloader menu organization

## SETTING CONFIGURATION OPTIONS

This section provides step-by-step instructions for setting autoloader configuration options. The instructions assume that you are using the operator panel to set options. If you are using the SCSI autoloader's Remote Management utility (described in [Chapter 4](#)), the selections are generally the same but you access menus and selections through web-style links and fields.

[Table 3-3](#) provides an overview of each configuration option. Read through the table to determine which options you need to set, then follow the steps on the referenced pages.

**Table 3-3** Autoloader configuration options

Configuration option	Description	See...
LCD Language	You can change the language for the LCD display from its default (English) to French, German, Spanish, Italian, or Portuguese.	<a href="#">“Changing the LCD Language” on page 27</a>
LCD Contrast	You can set the LCD's contrast to an appropriate level for your lighting conditions.	<a href="#">“Changing the LCD Contrast” on page 28</a>
Autoloader SCSI ID Tape Drive SCSI ID	The SCSI autoloader and tape drive must have separate SCSI IDs. You can view the default settings and change them if necessary.	<a href="#">“Changing the SCSI IDs” on page 29</a>
Emulation Mode	Changing the emulation mode is required if your backup application does not support the Magnum 1x7 LTO Autoloader, but does support one of these products: <ul style="list-style-type: none"> <li>▪ VXA AutoPak 1x10 autoloader</li> <li>▪ Exabyte EZ17 autoloader</li> <li>▪ Exabyte 210 library</li> </ul>	<a href="#">“Changing the Emulation Mode” on page 31</a>
Cleaning Cell Autoclean	These options allow you to set up automatic tape drive cleaning. <b>Note:</b> To use automatic cleaning, a cleaning cartridge must be installed in the autoloader (see <a href="#">page 62</a> ).	<a href="#">“Setting Up Automatic Tape Drive Cleaning” on page 32</a>
DHCP Addressing IP Address Subnet Mask Gateway Address	If you are using the autoloader's Ethernet interface, you can set the autoloader's IP address, subnet mask, and gateway address for communication across your Ethernet network. You can also choose whether the autoloader uses a fixed IP address (static addressing) or an address assigned by a DHCP server.	<a href="#">“Setting Ethernet Configuration Options” on page 35</a>

**Table 3-3** Autoloader configuration options (continued)

Configuration option	Description	See...
Operating Mode Loop Restart	<p>The operating mode (Random or Sequential) determines how cartridges are processed by the autoloader.</p> <ul style="list-style-type: none"> <li>▪ Random mode—the autoloader processes cartridges according to commands issued from an application.</li> <li>▪ Sequential Mode—the autoloader processes cartridges sequentially without direction from an application.</li> </ul> <p>If you plan to operate the autoloader in Sequential mode, set the Loop and Restart options to determine what the autoloader does after processing the last cartridge in the sequence and where the autoloader restarts after it is reset or power cycled.</p>	“Setting the Autoloader to Operate in Sequential Mode” on page 38
Password	By setting a password, you can prevent unauthorized personnel from using operator panel functions and possibly disrupting autoloader operation.	“Setting Up Autoloader Password Protection” on page 40
Restore Default Configuration	Resets all autoloader configuration settings to their default values.	“Restoring the Default Configuration” on page 44

## CHANGING THE LCD LANGUAGE

You can choose from the following languages for the LCD display:

- ▶ English (default)
- ▶ French
- ▶ German
- ▶ Spanish
- ▶ Italian
- ▶ Portuguese

To change the LCD language:



1. At the Home screen, press , , , or  to access the main menus.

If necessary, enter the operator panel password (see [page 42](#)).

2. Press  or  until the Configuration menu appears:

C h a n g e   a  
C o n f i g u r a t i o n



3. Press  to see the menu selections.

4. Press  or  until the following screen appears:

```
C h a n g e   L a n g u a g e ?
N o w   E n g l i s h
```



5. Press  to display the language selection screen:

```
S e l e c t   L a n g u a g e
N o w   E n g l i s h
```

6. Press  or  to scroll through the available languages until the one you want appears, then press  to select the new language.

A confirmation message appears:

```
S e t   L a n g u a g e   t o
x x x x x x x   N o w ?
```

7. Press  to enact the change (or  if you don't want to make the change).
8. Press  (as needed) to return to the Home screen.

## CHANGING THE LCD CONTRAST

If desired, you can change the LCD's contrast from its default setting to a level that is appropriate for your lighting conditions.



To change the LCD contrast:

1. At the Home screen, press , , , or  to access the main menus.

If necessary, enter the operator panel password (see [page 42](#)).

2. Press  or  until the Configuration menu appears:



```
C h a n g e   a
C o n f i g u r a t i o n
```

3. Press  to see the menu selections.
4. Press  or  until the following screen appears:



```
C h a n g e   C o n t r a s t
o n   L C D ?   N o w :   n n
```

5. Press  to display the contrast selection screen:

```
S e l e c t   C o n t r a s t
N o w :   n n
```

6. Press  or  to scroll through the available values until the one you want appears. The contrast changes as you press the button.
7. Press  to select the new value. A confirmation message appears:

```
S e t   c o n t r a s t   t o
n n   n o w ?
```

8. Press  to enact the change (or  if you don't want to make the change).
9. Press  (as needed) to return to the Home screen.

## CHANGING THE SCSI IDs

Each device on a SCSI bus must have a unique SCSI ID so that it can be identified by the host computer. The autoloader and the enclosed tape drive use separate IDs on the same SCSI bus so that they can receive different sets of commands. You can use the default IDs or change them if they conflict with other devices on the SCSI bus.

**Note:** If you change the autoloader or tape drive's SCSI ID after the autoloader has been in operation, you may need to reboot your host computer so that it recognizes the new ID.

### Autoloader SCSI ID

To change the autoloader's SCSI ID:



1. At the Home screen, press , , , or  to access the main menus.

If necessary, enter the operator panel password (see [page 42](#)).

2. Press  or  until the Configuration menu appears:

```
C h a n g e   a
C o n f i g u r a t i o n
```



3. Press  to see the menu selections.

4. Press  or  until the following screen appears:



```
C h a n g e   L i b r a r y
I D ?   N o w   =   n
```

5. Press  to display the autoloader (library) SCSI ID selection screen:

```
S e l e c t   S C S I   I D
N e w   L i b . I D =   n
```

6. Press  or  to scroll through the available values until the one you want appears. The default SCSI ID for the autoloader is 0.
7. Press  to select the new value. A confirmation message appears:

```
S e t   L i b r a r y   I D
t o   n n   n o w ?
```

8. Press  to enact the change (or  if you don't want to make the change). The autoloader resets and the new ID takes effect. The LCD displays the Home screen.

### Tape Drive SCSI ID



To change the tape drive's SCSI ID:

1. At the Home screen, press , , , or  to access the main menus.

If necessary, enter the operator panel password (see [page 42](#)).

2. Press  or  until the Configuration menu appears:



```
C h a n g e   a
C o n f i g u r a t i o n
```

3. Press  to see the menu selections.
4. Press  or  until the following screen appears:



```
C h a n g e   D r i v e
I D ?   N o w   =   n
```

- Press  to display the tape drive SCSI ID selection screen:

```
S e l e c t   S C S I   I D
N e w   D r i v e   I D n
```

- Press  or  to scroll through the available values until the one you want appears. The default SCSI ID for the tape drive is 1.
- Press  to select the new value. A confirmation message appears:

```
S e t   D r i v e   I D
t o   n   n o w   ?
```

- Press  to enact the change (or  if you don't want to make the change). The tape drive resets and the new ID takes effect. The Configuration menu is displayed.
- Press  (as needed) to return to the Home screen.





## CHANGING THE EMULATION MODE

By default, the autoloader operates in Native emulation mode and returns the product identification, "Magnum 1x7," in response to a SCSI INQUIRY command from an application. If your autoloader software has not yet been certified for the Magnum 1x7 LTO Autoloader, you can select an option that allows the autoloader to emulate the VXA AutoPak 1x10 autoloader, Exabyte EZ17 autoloader, or the Exabyte 210 library. [Table 3-4](#) lists the available emulation modes for the autoloader.

**Table 3-4** Emulation modes for the Magnum 1x7 LTO Autoloader



Emulation Mode	Returns this Product Identification in response to an INQUIRY command
Native 2-U	The default Product Identification stored in the autoloader's microcode.
AutoPak 110	"VXA_AutoPak_1x10" where each "_" represents an ASCII space character.
Exabyte EZ17	"Exabyte EZ17_ _ _ _" where each "_" represents an ASCII space character.
Exabyte 210	"EXB-210_ _ _ _ _ _ _ _" where each "_" represents an ASCII space character.

To change the emulation mode:

- At the Home screen, press , , , or  to access the main menus.  
If necessary, enter the operator panel password (see [page 42](#)).

2. Press  or  until the Configuration menu appears:



```
C h a n g e   a
C o n f i g u r a t i o n
```

3. Press  to see the menu selections.
4. Press  or  until the following screen appears:



```
C h a n g e   E m u l a t i o n
N o w   i n   N a t i v e
```

5. Press  to display the emulation mode selection screen:

```
S e l e c t   E m u l a t i o n
x x x x x x
```

6. Press  or  to scroll through the available modes until the one you want appears.
7. Press  to select the new value. A confirmation message appears:

```
S e t   E m u l a t i o n   t o
x x x x x x   n o w ?
```

8. Press  to enact the change (or  if you don't want to make the change).
9. Press  (as needed) to return to the Home screen.

---

**! Important** After changing the emulation mode, reboot your host computer so that it recognizes the new emulation mode.

---

## SETTING UP AUTOMATIC TAPE DRIVE CLEANING

The Autoclean option enables the autoloader to automatically perform tape drive cleaning without operator intervention. When Autoclean is enabled, the autoloader monitors the cleaning requirements of the tape drive. When the drive indicates it needs cleaning, the autoloader loads the cleaning cartridge into the tape drive. After the cleaning cycle is complete, the tape drive unloads and ejects the cleaning cartridge, and the autoloader resumes operation.



**Important** If you plan to use automatic cleaning, cleaning cartridge must be installed in cartridge cell 7 of the autoloader (see [page 62](#)).

If your autoloader software has a cleaning option, be sure to turn that option OFF.

**Note:** You do not have to use the autoloader's Autoclean option to clean the tape drive. You can choose from several other cleaning methods, including using your software's cleaning function and using commands available through the operator panel. See [page 70](#) for information about these cleaning alternatives.

Setting up automatic tape drive cleaning involves two procedures:

- ▶ [Activating the Cleaning Cartridge Cell](#)
- ▶ [Enabling the Autoclean Option](#)

### Activating the Cleaning Cartridge Cell

Activating the cleaning cartridge cell designates cartridge cell 7 as the storage location for a cleaning cartridge.



To activate the cleaning cartridge cell:

1. At the Home screen, press , , , or  to access the main menus.

If necessary, enter the operator panel password (see [page 42](#)).

2. Press  or  until the Configuration menu appears:

```
C h a n g e  a
C o n f i g u r a t i o n
```

3. Press  to see the menu selections.
4. Press  or  until the following screen appears:

```
C h a n g e  F i x e d  C l n
C e l l , N o w  i t s  O F F
```

5. Press  to display the cleaning cartridge cell activation screen:

```
S e l e c t  F i x e d  C l n
C e l l , N o w  i t s  O F F
```



6. Press  or  to switch between OFF and ON.

7. Press  to select the new value. A confirmation message appears:

```

S e t   F i x e d   C l e a n
C e l l   t o   O N   N o w ?

```

8. Press  to enact the change (or  if you don't want to make the change).
9. Press  (as needed) to return to the Home screen.

### Enabling the Autoclean Option

After setting up the cleaning cartridge cell, you can turn on autocleaning by enabling the Autoclean option:

**Note:** If you have just set up the cleaning cartridge cell and have not returned to the Home screen, skip to step 4.

1. At the Home screen, press , , , or  to access the main menus.



If necessary, enter the operator panel password (see [page 42](#)).

2. Press  or  until the Configuration menu appears:

```

C h a n g e   a
C o n f i g u r a t i o n

```

3. Press  to see the menu selections.
4. Press  or  until the following screen appears:

```

C h a n g e   A u t o C l e a n
N o w   i t s   O F F



```

5. Press  to display the autoclean selection screen:

```

S e l e c t   A u t o C l e a n
A u t o C l e a n   O F F

```

6. Press  or  to switch between OFF and ON.
7. Press  to select the new value. A confirmation message appears:

```

S e t   A u t o C l e a n   t o
O N   N o w ?

```

8. Press  to enact the change (or  if you don't want to make the change).

9. Press  (as needed) to return to the Home screen.

## SETTING ETHERNET CONFIGURATION OPTIONS

**Table 3-5** Ethernet configuration options

<b>Remote Management Utility</b>	<p>The Remote Management utility allows you to connect to the autoloader's Ethernet interface to remotely monitor operations, upgrade firmware, and create diagnostic listings. See:</p> <ul style="list-style-type: none"> <li>▪ Connecting the library to Ethernet—<a href="#">page 18</a></li> <li>▪ Using the Remote Management utility—<a href="#">Chapter 4</a></li> </ul>
<b>Ethernet</b>	<p>Configuring the autoloader's Ethernet interface typically involves specifying the library's IP address, subnet mask, and gateway address.</p> <ul style="list-style-type: none"> <li>▪ IP address—Used to route information from the autoloader to the server. You can choose between dynamic (server-assigned) or static (user-assigned) addressing for the IP address.</li> <li>▪ Subnet Mask—Used to route information to designated devices within the network.</li> <li>▪ Gateway address—Allows information to be routed outside the subnet.</li> </ul>
<b>Network Addresses</b>	<p>This allows you to select the method used to set the Internet Protocol (IP) address for the library, as follows:</p> <ul style="list-style-type: none"> <li>▪ Static—The library uses a fixed IP Address, which is assigned in the IP Address option.</li> <li>▪ DHCP—The library uses an IP address assigned by the network DHCP (Dynamic Host Configuration Protocol) server.</li> </ul>

**Table 3-5** Ethernet configuration options (continued)

<b>SNMP</b>	<p>If you are using a network-based monitor/management application other than the autoloader's Remote Management utility, you may need to identify the autoloader's Simple Network Management Protocol (SNMP) settings to the application. These settings include:</p> <ul style="list-style-type: none"> <li>▪ Read community string</li> <li>▪ Write community string</li> <li>▪ Broadcast community string</li> <li>▪ Trap address</li> <li>▪ Trap port</li> </ul> <p>You can view and change these settings only through the autoloader's Remote Management utility. See <a href="#">Chapter 4</a> for instructions.</p>
<b>FTP Interface</b>	<p>The autoloader also includes an FTP interface that you can use to transfer firmware files or create diagnostic listings. You can:</p> <ul style="list-style-type: none"> <li>▪ Set up an FTP user name and password for this interface or use the autoloader's defaults</li> <li>▪ View and change the FTP settings only through the library's Remote Management utility</li> <li>▪ For instructions, see <a href="#">Chapter 4</a>.</li> </ul> <p>For information about accessing the autoloader's FTP interface and using an FTP utility to upgrade firmware or obtain diagnostic listings, see <a href="#">page 100</a>.</p>

### Setting the Ethernet Addresses

To set Ethernet addresses:

1. At the Home screen, press , , , or  to access the main menus.



If necessary, enter the operator panel password (see [page 42](#)).

2. Press  or  until the Configuration menu appears:

```

C h a n g e   a
C o n f i g u r a t i o n

```

3. Press  to see the menu selections.
4. Press  or  until the following screen appears:



```

C h a n g e   I P   A d d r ?
D H C P   I s   O N



```

5. Press  to display the DHCP selection screen:







```
S e l e c t   D H C P
D H C P   i s   O N
```

6. Press  or  to switch between ON and OFF.
- ▶ Select OFF if you want to specify an IP address.
  - ▶ Select ON (the default) if you want the IP address to be server-assigned.
7. Press . If you selected OFF, skip to step 8. If you selected ON, a confirmation message appears:







```
S e t   D H C P   t o   O N
N o w   ?
```

- a. Press  to enact the change (or  if you don't want to make the change).
  - b. Skip to step 9.
8. If you selected OFF at the DHCP selection screen, the IP address selection screen appears:

```
S e t   I P   A d d r e s s
_ 0 0 0 . 0 0 0 0 . 0 0 0 0 . 0 0 0 0
```

- a. Use  or  to move through the segments of the address (as indicated by the underscore). Use  and  to increase or decrease the value of an address segment. Press and hold  and  to move rapidly through the available values.
- b. When you have entered the desired IP address, press . The subnet mask selection screen appears:

```
S e t   S u b n e t   A d d r .
_ 0 0 0 . 0 0 0 0 . 0 0 0 0 . 0 0 0 0
```

- c. Use  or  to move through the segments of the address (as indicated by the underscore). Use  and  to increase or decrease the value of an address segment. Press and hold  and  to move rapidly through the available values.

- d. When you have entered the desired Subnet mask, press . The gateway address selection screen appears:

```
S e t   G a t e w a y   A d r .
0 0 0 . 0 0 0 . 0 0 0 . 0 0 0
```

- e. Use or to move through the segments of the address (as indicated by the underscore). Use and to increase or decrease the value of an address segment. Press and hold and to move rapidly through the available values.
- f. When you have entered the desired Gateway address, press . A confirmation message appears:

```
S e t   D H C P   o f f   a n d
n e w   I P   A d d r   N o w ?
```

- g. Press to enact the change (or if you don't want to make the changes).
9. Press (as needed) to return to the Home screen.

**Note:** If you set DHCP on, you can view the current server-assigned IP address for the autoloader through the Status menu (see [page 79](#)).

## SETTING THE AUTOLOADER TO OPERATE IN SEQUENTIAL MODE

The operating mode determines how the autoloader processes cartridges. There are two operating modes:

- ▶ **Random (the default)**—The autoloader processes cartridges according to commands issued from an application.
- ▶ **Sequential**—The autoloader processes cartridges sequentially without direction from an application.

---

**! Important** If you are using a backup application which is capable of controlling the autoloader, do *not* configure the library to operate in Sequential mode.

---

To customize how sequential mode works, you can set the Restart and Loop options:

- ▶ **Restart option.** The Restart option determines what the autoloader does after it is reset or power cycled. The autoloader can either restart at the beginning of the cartridge sequence (Restart option ON) or resume where it left off when the interruption occurred (Restart option OFF).

- ▶ **Loop option.** The Loop option determines what the autoloader does after it has finished processing the last cartridge in the sequence. The autoloader can either loop back to the first cartridge in the sequence and start processing the cartridges again (Loop option ON) or stop and wait for operator intervention (Loop option OFF). Operator intervention typically means removing cartridges for storage and inserting new cartridges.



Random is the default operating mode for the autoloader. To change the operating mode to Sequential and set the Restart and Loop options:

1. At the Home screen, press , , , or  to access the main menus.

If necessary, enter the operator panel password (see [page 42](#)).

2. Press  or  until the Configuration menu appears:



```
C h a n g e   a
C o n f i g u r a t i o n
```

3. Press  to see the menu selections.
4. Press  or  until the following screen appears.



```
C h a n g e   O p .   M o d e ?
N o w   R a n d o m
```

5. Press  to display the operating mode selection screen:

```
S e l e c t   O p .   M o d e
R a n d o m   M o d e
```

6. Press  or  to switch between Random Mode and Sequential Mode.
7. Press  to select the new value. If you selected Sequential Mode, skip to step 8. If you selected Random mode, a confirmation message appears:

```
S e t   O p .   M o d e   t o
R a n d o m   n o w ?
```



- a. Press  to enact the change (or  if you don't want to make the change).
- b. Skip to step 9.

8. If you selected Sequential Mode, the Restart option selection screen appears:

```

R e s t a r t   a t   F i r s t
A d d r e s s :   N O



```

- Press  or  to switch between NO and YES.
- Press  to select the new value. The Loop option selection screen appears:

```

L o o p   W h e n   D o n e
S e t   L o o p i n g   O F F



```

- Press  or  to switch between OFF and ON.
- Press  to select the new value. A confirmation message appears:

```

S e t   O p .   M o d e   t o
S E Q U E N T I A L   N o w ?

```

- Press  to enact the change (or  if you don't want to make the change).
9. Press  (as needed) to return to the Home screen.

## SETTING UP AUTOLOADER PASSWORD PROTECTION

To prevent unauthorized users from disrupting autoloader operation, you can set up a password for accessing operator panel menus. When you enable the password, all operator panel functions are prevented, including:







- ▶ Changing configuration settings
- ▶ Importing and exporting cartridges
- ▶ Loading and unloading the tape drive
- ▶ Cleaning the tape drive
- ▶ Running demos
- ▶ Resetting the autoloader

**Note:** If you are using the autoloader's Remote Management utility (see [Chapter 4](#)), you can set up a separate password to prevent unauthorized users from using the utility to access the autoloader's configuration settings.





## Setting Up an Operator Panel Password

To set up a password for the operator panel:

1. At the Home screen, press , , , or  to access the main menus.
2. Press  or  until the Configuration menu appears:



```
C h a n g e   a
C o n f i g u r a t i o n
```

3. Press  to see the menu selections.
4. Press  or  until the following screen appears:

```
C h a n g e   P a s s w o r d
E n t r y ?       N o w   O F F
```







5. Press  to display the password activation screen:

```
S e l e c t   P a s s w o r d
P r o t e c t i o n       O F F
```

6. Press  or  to display ON.
7. Press  to display the password entry screen:

```
S e l e c t   N e w   P a s s W
> > > >                               < < < < <
```



You can enter a password of up to six characters, including blanks. The password is not case-sensitive.

- a. Use  or  to move through character positions in the password.
  - b. Use  and  to enter or change characters.
  - c. Press and hold  or  to move rapidly through the available characters.
8. Press . A confirmation message appears:

```
S e t   P a s s w o r d   t o
x x x x x x                               N o w ?
```

9. Press  to accept the password (or  to cancel the action).

10. Press  until the Home screen appears. Press  again or wait two minutes without pressing any buttons for the password to take effect.

**Note:** If you want to continue using menus after you have set a password, do not press  the additional time after reaching the Home screen. The password will not take effect until you have pressed  an additional time at the Home screen or you have pressed no buttons for two minutes.







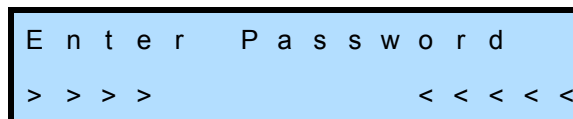

When password protection is in effect, you must enter the password before you can use the operator panel menus. Each time you return to the Home screen and press  an additional time (or wait two minutes), password protection is re-activated; you must enter the password again to access the menus.

### Accessing Password Protected Operator Panel Menus

If you need to gain access to the operator panel menus, but want password protection to remain in effect:

1. At the Home screen, press , , , or . The password entry screen appears:







- a. Enter the password you set previously.
  - b. Use  or  to move through character positions in the password.
  - c. Use  or  to enter or change characters.
  - d. Press and hold  or  to move rapidly through the available characters.
2. Press . You now have access to the operator panel menus.
  3. After you have finished using the menus, press  until the Home screen appears. Then, press  again or wait two minutes without pressing any buttons for password protection to be reactivated.

### Turning Off the Operator Panel Password

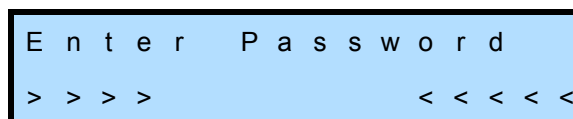

To turn off password protection for the operator panel:

1. At the Home screen, press , , , or . The password entry screen appears:



2. Enter the password you set previously and press .
3. Press  or  until the Configuration menu appears:



```
C h a n g e   a
C o n f i g u r a t i o n
```

4. Press  to see the menu selections.
5. Press  or  until the following screen appears:



```
C h a n g e   P a s s w o r d
E n t r y ?   N o w   O N
```

6. Press  to display the password activation screen:

```
S e l e c t   P a s s w o r d
P r o t e c t i o n   O N
```

7. Press  or  to display OFF.
8. Press . A confirmation message appears:

```
S e t   P a s s w o r d
P r o t e c t i o n   O F F ?
```

9. Press  to enact the change (or  if you don't want to make the change).
10. Press  (as needed) to return to the Home screen.

### Setting Security Through Your Application

As an alternative to password protection, you may be able to set up security for the autoloader through your software application. If your application supports this feature, you can issue commands from the application to turn security on and off. Refer to your software documentation for information.

Whichever method you use to enable security (operator panel password or application), you must also use it to disable security. That is, if you enable a password at the operator panel, you must disable it at the operator panel. If you enable security through your application, you must disable it through the application.

---

**! Important** If you enable security through your application, use of the cartridge access port is not prevented. Separate commands for preventing and allowing use of the cartridge access port may be available through your application. Refer to your software documentation for information.

---

## RESTORING THE DEFAULT CONFIGURATION

If necessary you can return all of the autoloader configuration settings to their default values.

---

**! Important** When you use this option all changes that you previously made to any of the autoloader's configuration settings are lost.

---

To restore the default configuration values:



1. At the Home screen, press , , , or  to access the main menus.

If necessary, enter the operator panel password (see [page 42](#)).

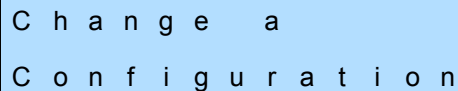
2. Press  or  until the Configuration menu appears:



C h a n g e a  
C o n f i g u r a t i o n

3. Press  to see the menu selections.
4. Press  or  until the following screen appears:

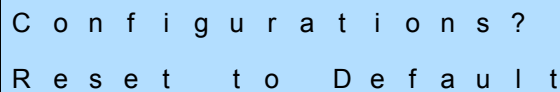

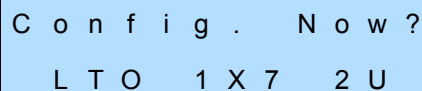

C o n f i g u r a t i o n s ?  
R e s e t t o D e f a u l t

5. Press  to display the restore default configuration screen:



C o n f i g . N o w ?  
L T O 1 X 7 2 U

6. Press  to reset the defaults (or  if you don't want to make the change). The autoloader resets and the default configuration settings take effect. The LCD displays the Home screen.

## CHECKING THE SETUP

After configuring the autoloader, check the setup by performing the exercises suggested below. While these exercises are not required, it is a good idea to verify that your software and hardware are properly communicating before you begin operation.

- ▶ Import several cartridges into the autoloader, and load and unload cartridges into the tape drive. See [page 62](#) for instructions. You may also want to run a system demo. See [page 75](#) for instructions. These exercises help determine whether the autoloader's hardware components are operating properly.
- ▶ If you have not already done so, install the software application on the host computer. Instruct the software to load and unload one or more cartridges in the tape drive. This helps determine whether the software and autoloader are communicating properly.
- ▶ Back up several megabytes of data with the tape drive and perform a comparison check on the backed-up data. This determines whether the software and tape drive are communicating properly.

If the autoloader and tape drive are not operating as expected, see

- ▶ [Chapter 8](#) for troubleshooting tips
- ▶ [Appendix C](#) for error message descriptions and corrective actions

If you cannot resolve the problem yourself, contact Exabyte Technical Support (see [page iii](#)).

## NOTES

# 4

## USING THE REMOTE MANAGEMENT UTILITY

The autoloader's Remote Management utility allows you to set configuration options, view autoloader information, and monitor operation across an Ethernet network. You can access the Remote Management utility using a standard web browser.

This chapter explains how to access the Remote Management utility and describes the configuration options and information available through the utility. If you plan to use the utility, refer to this chapter in conjunction with [Chapter 3 – Configuring the Autoloader](#).

### ACCESSING THE REMOTE MANAGEMENT UTILITY

To access the autoloader's Remote Management utility:

1. Connect the autoloader to your Ethernet network as described on [page 18](#).
2. If not already powered on, power on the autoloader as described on [page 19](#).
3. Use the autoloader's operator panel to set up the Ethernet interface as described on [page 35](#). Make a note of the autoloader's IP address.

**Note:** If you set DHCP on, you can view the current server-assigned IP address for the autoloader through the Status menu (see [page 79](#)).

4. Launch your web browser and enter the autoloader's IP address in the following format:

`http://IP address`

5. Press Enter. The utility's Home page appears. [Figure 4-1](#) shows an example of the Home (Status) page.

Home · Configure · Statistics · Diagnostics

**Library Information**

Device	Vendor	Product	Serial Number	Firmware Rev	SCSI ID
Library	EXABYTE	LTO 1x7 2U	000087002909	B009	0
Drive	HP	Ultrium 3-SCSI	HU10623FA6	D217	1

**Library Status**

LCD: LTO 1x7 2U Ultrium 3-S D217  
 Motion: Idle  
 Robot Control Mode: SCSI  
 Door Closed  
 Library temperature: Normal  
 Front door: NOT locked  
 Language: English  
 Auto Clean: OFF No Clean Slot

**Tape Drive Status**

Index	Status
82	Inactive

**Inventory**

Index	What	POVAR	Label valid	Label
1	Slot	11110	1	A00009
2	Slot	11110	1	A00014
3	Slot	11110	1	A00012
4	Slot	11110	1	A00010
5	Slot	11110	1	A00009
6	Slot	11110	1	A00004
7	Slot	11110	1	A00014
82	Drive	10110	1	
86	Robot	10100	1	

Automatically refresh library status  
 Update

Figure 4-1 Remote Management utility Status page

**Note:** You can click on these links from any page for quick access to the following:

Click this Link...	for quick access to this location...
Home, Configure, Statistics, and Diagnostics	Autoloader and tape drive options and information
Exabyte Logo	Exabyte’s web site at <a href="http://www.exabyte.com">www.exabyte.com</a>
Product name (LTO 1x7 2U)	The utility’s Home screen page



## VIEWING INFORMATION ON THE HOME (STATUS) PAGE

The Status page is the “home page” for the utility. The Status page provides information in four sections:

- ▶ Library Information
- ▶ Library Status
- ▶ Tape Drive Status
- ▶ Inventory

At the bottom of the Status page is an Update button that refreshes the information on the page. An option for automatically refreshing the page is also available. Check this option to have the information refreshed approximately every 6 seconds.

The information available on the Status page is described below.

### LIBRARY INFORMATION

The Library Information section includes the following information for the autoloader and tape drive:

Field	Indicates the...
<b>Device</b>	library and tape drive
<b>Vendor</b>	vendor identification value (EXABYTE) as reported in response to an INQUIRY command from an application
<b>Product</b>	product identification value as reported in response to an INQUIRY command from an application: <ul style="list-style-type: none"> <li>▪ “ LTO 1x7 2U “for the autoloader</li> <li>▪ “Ultrium-TD2” or “Ultrium-TD3” for the tape drive</li> </ul> <b>Note:</b> If you change the autoloader’s emulation mode from its default (Native), the autoloader’s Product Identification value changes to match the new emulation mode (see <a href="#">page 31</a> ).
<b>Serial Number</b>	autoloader or tape drive’s serial number
<b>Firmware Rev</b>	autoloader or tape drive’s current firmware revision level
<b>SCSI ID</b>	autoloader or tape drive’s current SCSI ID. You can change the SCSI IDs from the utility’s Configuration page (see <a href="#">page 53</a> ).

## LIBRARY STATUS

The Library Status section includes the following information:

Field	Indicates...
<b>LCD</b>	the current message displayed on the autoloader's LCD
<b>Motion</b>	the type of motion currently being performed by the cartridge loader
<b>Robot Control Mode</b>	the current operating mode for the autoloader (Random or Sequential) See <a href="#">page 38</a> for information about operating modes. You can change the robot control mode from the utility's Configuration page (see <a href="#">page 53</a> ).
<b>Door Open/Closed Sensor</b>	the current reading of the door sensor for the cartridge access port door: Door Open or Door Closed
<b>Library Temperature</b>	whether the autoloader's current internal temperature is within the normal operating range. See <a href="#">page 123</a> for operating temperature requirements.
<b>Front Door Locked or Not Locked by Host</b>	whether or not the cartridge access port is locked by an application. (For security purposes, an application can issue a PREVENT MEDIUM REMOVAL command to the autoloader to disable the cartridge access port.)
<b>Language</b>	the current language used on the autoloader's LCD You can change the LCD language from the utility's Configuration page (see <a href="#">page 53</a> ).
<b>Auto Clean ON/OFF</b>	whether the autoloader is set to perform clean the tape drive automatically when required See <a href="#">page 32</a> for information about the Autoclean option. You can change the Autoclean option from the utility's Configuration page (see <a href="#">page 53</a> ).
<b>Cleaning Tape Installed/No Cleaning Tape Installed</b>	whether cell 7 in the autoloader has been designated as the storage location for a cleaning cartridge See <a href="#">page 32</a> for information about enabling the cleaning cartridge cell. You can enable the cleaning cartridge cell from the utility's Configuration page (see <a href="#">page 53</a> ).

## TAPE DRIVE STATUS

The Tape Drive Status section includes the following information:

Field	Indicates...
<b>Index</b>	the element index of the tape drive (82). (Element indexes identify locations within the autoloader that can accept a cartridge.)
<b>Status</b>	whether the tape drive is active (tape motion is occurring) or inactive (idle)

## INVENTORY

The Inventory section provides information from the autoloader's cartridge inventory. The autoloader maintains a cartridge inventory to keep track of where cartridges are located. An inventory is automatically performed each time the autoloader is powered on, each time a cartridge is inserted or removed from the autoloader, and each time a cartridge is loaded or unloaded from the tape drive. In performing an inventory, the autoloader checks for cartridges in the cells and scans each cartridge's bar code label.

The Inventory section includes the following information:

Field	Description
<b>Index</b>	Indicates the element index of the cartridge cell, tape drive, or robot (cartridge loader). The cell element indexes are 1 through 7, the tape drive element index is 82, and the robot element index is 86. (Element indexes identify locations within the autoloader that can accept a cartridge.)
<b>What</b>	Indicates the type of element (cell, drive, or robot).

Field	Description
<b>POVAR</b>	<p>Provides information about individual elements.</p> <ul style="list-style-type: none"> <li>▪ <b>P (present)</b> – Indicates whether the element is present (1) or not (0).</li> <li>▪ <b>O (occupied)</b> – Indicates whether the element contains a cartridge (1) or not (0).</li> <li>▪ <b>V (valid)</b> – Indicates whether the occupied information for the element is considered valid (1) or questionable (0). The occupied information is considered questionable just after power up before the autoloader has completed its initial cartridge inventory.</li> <li>▪ <b>A (accessible)</b> – Indicates whether the element is accessible (1) or not (0). In the case of a cartridge cell, this value is always 1. In the case of the tape drive, 1 means the tape drive is either empty or the cartridge is ejected from the tape drive; 0 means a cartridge is loaded in the tape drive.</li> <li>▪ <b>R (reserved)</b> – Indicates whether the element is reserved by a host (1) or not (0).</li> </ul>
<b>Label Valid</b>	<p>Indicates whether the bar code label information for the element is considered valid (1) or questionable (0). The bar code label information is considered questionable if the autoloader had a problem reading the label.</p>
<b>Label</b>	<p>If the element contains a cartridge, this field provides the bar code label information for the cartridge.</p>

## SETTING CONFIGURATION OPTIONS

Click on Configure at the top of the page to view the Configuration page. [Figure 4-2](#) shows an example of the Configuration page.

From the Configuration page, you can change settings in the following sections:

- ▶ Change Library Configuration
- ▶ Change Ethernet Configuration
- ▶ Change Web Access Password

If desired, you can password-protect the Configuration page to prevent unauthorized users from making changes (see [page 58](#)).

To enact changes you make on the Configuration page, enter the password (if you previously set one) in the Web Access Password field, and click on the Update button below the fields (see [Figure 4-2](#)). A confirmation message appears. Click on the link provided or the product name to return to the Status page.

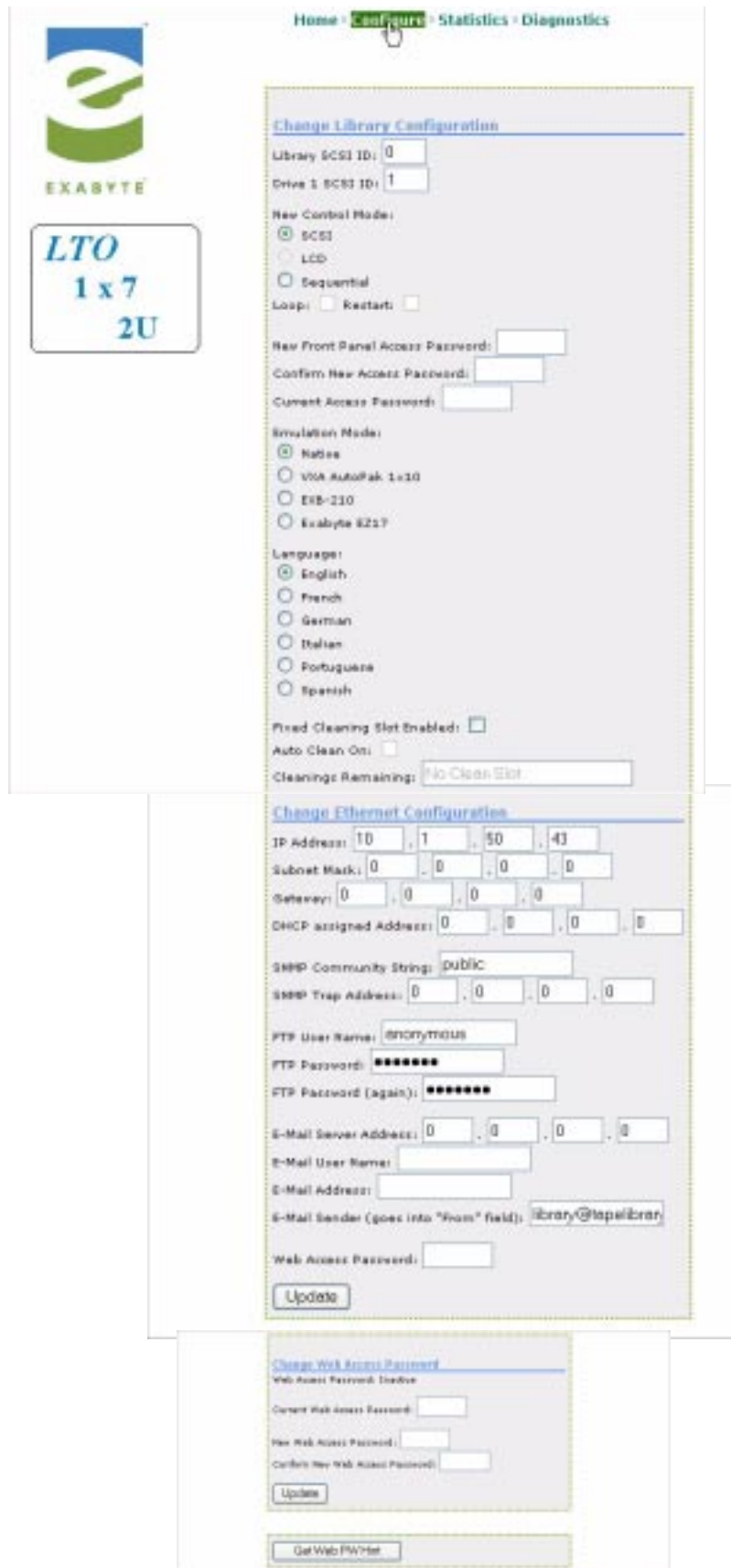

Figure 4-2 Remote Management utility Configuration page

## CHANGE LIBRARY CONFIGURATION

In the Change Library Configuration section, you can change the following settings:

Field	Description
<b>Library SCSI ID and Drive 1 SCSI ID</b>	You can change the SCSI IDs for the autoloader or tape drive if they conflict with other devices on the SCSI bus. See <a href="#">page 29</a> for more information about SCSI IDs.
<b>New Control Mode</b>	The default robot control mode for the autoloader is Random. When operating in Random mode, the autoloader processes cartridges according to commands issued by an application. If you want the autoloader to process cartridges sequentially, without instructions from an application, you can set the control mode to Sequential. If you select Sequential mode, set the Loop and Restart options as desired. See <a href="#">page 38</a> for information about Sequential mode and the Loop and Restart options.
<b>New Front Panel Access Password, Confirm New Access Password, Current Access Password</b>	<p>If desired, you can use the Remote Management utility to change the password that protects access to the autoloader's menus from the front panel. (See <a href="#">page 40</a> for more information about password protecting the front panel menus.)</p> <p>To set or change this password, enter a new password in the New Front Panel Access Password field. The password can be from 1 to 6 characters and can include spaces. The password is not case-sensitive. Re-enter the new password in the Confirm New Access Password field. If you are changing an existing password, enter the current password in the Current Access Password Field.</p> <p>To cancel an existing password, enter the current password in the Current Access Password Field and leave the New Front Panel Access Password and Confirm New Access Password fields blank.</p> <p><b>Note:</b> The front panel access password is separate from the web access password that prevents using the Remote Management utility to make changes to the autoloader's configuration (see <a href="#">page 58</a>).</p> <p>This password is separate from the web access password that prevents using the Remote Management utility to make changes to the autoloader's configuration (see <a href="#">page 58</a>).</p>

Field	Description
<b>Emulation Mode</b>	If your autoloader software has not yet been certified for the Magnum 1x7 LTO Autoloader, you can set the autoloader to emulate the VXA AutoPak 1x10 autoloader, EZ17 autoloader, or EXB-210 library. Because most backup applications are certified for these libraries, changing the emulation mode may allow these applications to support the autoloader. See <a href="#">page 31</a> for more information about emulation modes.
<b>Language</b>	The default language for the autoloader's LCD is English. You can change the language to French, German, Italian, Portuguese, or Spanish.
<b>Change Fixed Cleaning Cell, Auto Clean On, Cleanings Remaining</b>	The Autoclean option enables the autoloader to automatically perform tape drive cleaning without operator intervention. See <a href="#">page 32</a> for information about the Autoclean option. If you set the Autoclean option on, you must install a cleaning cartridge in cell seven of the autoloader and enable the fixed cleaning cell (see <a href="#">page 32</a> ).

## CHANGE ETHERNET CONFIGURATION

In the Change Ethernet Configuration section, you can specify the autoloader's IP address, subnet mask, and gateway address. You can also view and change the autoloader's SNMP settings, including the read, write, and broadcast passwords, trap address, and trap port. See [page 35](#) for information about the autoloader's Ethernet addresses and SNMP settings.

The autoloader also includes an FTP interface that you can use to transfer firmware files or create diagnostic listings. You can view the autoloader's default FTP user name and password and change them if desired. For information about accessing the autoloader's FTP interface and using an FTP utility to upgrade firmware or obtain diagnostic listings, see [page 100](#).

In the Change Ethernet Configuration section, you can change the following settings:

Field	Description
<b>IP Address, Subnet Mask, Gateway</b>	If you are using static addressing (DHCP off), specify the values for these addresses. If you are using dynamic addressing, specify 0 for these addresses.
<b>DHCP Assigned Address</b>	If you are using dynamic addressing (DHCP on), this field indicates the IP address. <b>Note:</b> If the DHCP address changes during your session, you will need to check the new address on the autoloader's LCD (see <a href="#">page 79</a> ) and re-direct your browser to the new address.



Field	Description
<b>SNMP Read Password, SNMP Write Password, SNMP Broadcast Password, SNMP Trap Address, SNMP Trap Port</b>	<p>If you need to identify the autoloader's SNMP settings to an application, you can view the settings and change them, if desired. The default values are:</p> <ul style="list-style-type: none"> <li>▪ SNMP Read Password: public</li> <li>▪ SNMP Write Password: private</li> <li>▪ SNMP Broadcast Password: private-traps</li> <li>▪ SNMP Trap Address: 0.0.0.0</li> <li>▪ SNMP Trap Port: 162</li> </ul> <p><b>Note:</b> The passwords are case-sensitive.</p>
<b>FTP User Name, FTP User Password</b>	<p>If you plan to use the autoloader's FTP interface to upgrade firmware or obtain diagnostic listings, you can view the default FTP user name and password and change them, if desired. The default values are:</p> <ul style="list-style-type: none"> <li>▪ User name: anonymous</li> <li>▪ Password: Exabyte</li> </ul> <p><b>Note:</b> The user name and password are case-sensitive.</p>
<b>E-Mail Server Address, E-Mail User Name, E-Mail Address, E-Mail Sender</b>	<p>If desired, you can receive e-mail alerts from the autoloader in the event of error conditions or exceptions. If you want to receive these e-mail alerts, enter the IP address of your e-mail server, your e-mail user name, and your e-mail address. You can also enter a sender e-mail address that will appear in the "From" field of messages sent from the autoloader. This address can be anything you like, but be aware that some e-mail servers have limitations on the type of address you can specify.</p>
<b>Web Access Password</b>	<p>If you have set up a password for changing options on the Configuration page (see the following section), enter the password here before you click on the Update button to enact the changes.</p> <p><b>Note:</b> If you forget your web access password, click on Get Web PW Hint at the bottom of the Configuration page. You will see an encrypted version of your password. Contact Exabyte Technical Support at one of the phone numbers provided to have your password decrypted.</p>

## CHANGE WEB ACCESS PASSWORD

If desired, you can set up a password to prevent unauthorized users from using the Remote Management utility to change the autoloader's configuration settings from the Configuration page. To set up a password, use the following fields:

Field	Description
<b>Current Web Access Password</b>	If a password has already been set and you want to change it, enter the current password.
<b>New Web Access Password</b>	Enter a new password for the page. The password can be from 1 to 6 letters and can include spaces. The password is not case-sensitive.
<b>Confirm New Web Access Password</b>	Re-enter the new password.

After filling in the fields, click on the Update button below the fields to enact the password.

If you want to cancel the password, enter the current password in the Current Web Access Password, and leave the New Web Access Password and Confirm New Web Access Password fields blank. Then, click on the Update button.

## VIEWING INFORMATION ON THE STATISTICS PAGE

Click on Statistics at the top of the page to view the Statistics page. [Figure 4-3](#) shows an example of the Statistics page.

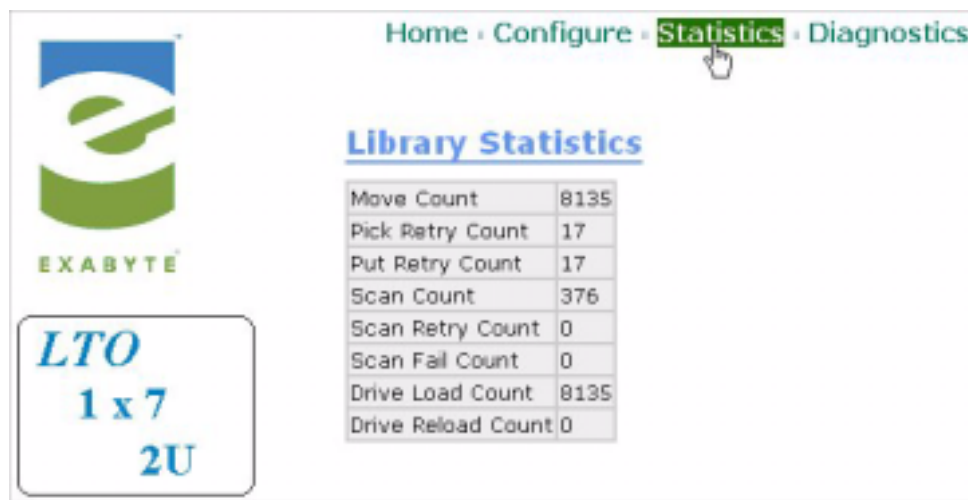

**Figure 4-3** Remote Management utility Statistics page

The Statistics page provides the following information:

Field	Indicates the total number of...
<b>Move Count</b>	moves that have taken place in the autoloader. A move is when the cartridge loader removes a cartridge from its cell and places it in the tape drive or removes a cartridge from the tape drive and places it in its cell.
<b>Pick Retry Count</b>	times the cartridge loader has retried removing a cartridge from a cell or from the tape drive.
<b>Put Retry Count</b>	times the cartridge loader has retried placing a cartridge in a cell or in the tape drive.
<b>Scan Count</b>	times the bar code scanner has scanned a bar code label
<b>Scan Retry Count</b>	times the bar code scanner has retried scanning a bar code label
<b>Scan Fail Count</b>	times the bar code scanner failed scanning a bar code label The scanner tries to scan a bar code several times before it logs a failure.
<b>Drive Load Count</b>	times the cartridge loader has loaded a cartridge into the tape drive
<b>Drive Reload Count</b>	times the cartridge loader has retried loading a cartridge into the tape drive

## RUNNING DIAGNOSTICS

Click on Diagnostics at the top of the page to view the Diagnostics page. [Figure 4-4](#) shows an example of the Diagnostics page.

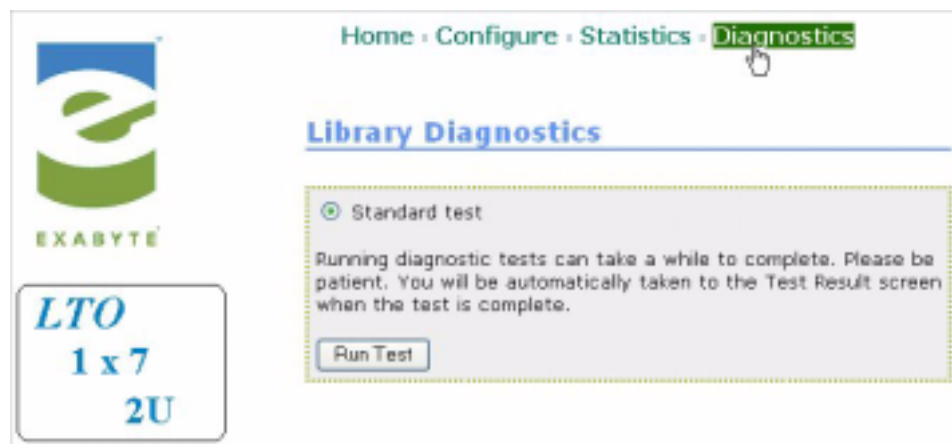

**Figure 4-4** Remote Management utility Diagnostics page

The standard test is the same as the diagnostic tests that can be run from the operator panel (see [page 77](#)). To run the standard diagnostic test, click on Run Test. When the test is finished, the utility displays the results.

## NOTES

# 5



## AUTOLOADER OPERATION

After you have configured your autoloader, you can add cartridges and put it into operation. If you operate the autoloader in:

- ▶ **Random mode** (the default)—your autoloader application controls which cartridges are moved to and from the tape drive
- ▶ **Sequential mode** (see [page 38](#))—the autoloader automatically processes the cartridges in sequential order

In both cases, your backup application controls backup and restore jobs in the tape drive.

You can monitor autoloader operations by viewing the operator panel or by using the autoloader's Remote Management utility (see [Chapter 4](#)). The operator panel provides continuous updates on the activities of the autoloader and tape drive. The status LED, located to the right of the operator panel buttons, also indicates autoloader activity as follows:

LED	Color	Status
	Off (no color)	The autoloader is idle
	Green	The autoloader is performing a mechanical operation
	Amber	The autoloader encountered a hardware error See <a href="#">Appendix C, Error Messages</a>



**Figure 5-1** Location of status LED

During normal operation, you do not need to intervene in autoloader activities. However, you may occasionally need to perform the following tasks, described in this chapter:

- ▶ Insert and remove cartridges
- ▶ Load and unload cartridges from the tape drive
- ▶ Clean the tape drive
- ▶ Reset the autoloader
- ▶ Run system demos
- ▶ Perform diagnostic tests
- ▶ Store cartridges that you have removed from the autoloader

## INSERTING AND REMOVING CARTRIDGES

To insert and remove cartridges from the autoloader, you use the operator panel and the cartridge access port (see [Figure 5-2](#)).

**Note:** In the event of a general power failure or a failure of the autoloader's power supply, you can operate the cartridge access port manually if you need to remove cartridges. See [page 67](#) for instructions.

For convenience, you can use cell 7 in the autoloader to store a cleaning cartridge for the tape drive. Refer to [“Cleaning the Tape Drive” on page 70](#) for information that will help you determine whether you want to store a cleaning cartridge in the autoloader.



**Figure 5-2** Location of cartridge access port

**Note:** For data security, you can prevent use of the cartridge access port by setting a password for the operator panel (see [page 40](#)) or by issuing commands from the autoloader application (refer to your software documentation).

## PREPARING CARTRIDGES

Be sure to use the appropriate cartridges for the tape drive. [Table 5-1](#) shows the cartridge and write/read compatibility for the LTO Ultrium tape drive in the autoloader.

**Table 5-1** Tape drive cartridge read/write compatibility

LTO Ultrium Tape Drive	Ultrium 3 (slate blue)		Ultrium 2 (purple)		Ultrium 1 (black)		LTO Ultrium cleaning cartridge
	Read	Write	Read	Write	Read	Write	
LTO-3	✓	✓	✓	✓	✓	No	✓
LTO-2	No	No	✓	✓	✓	✓	✓

Before inserting cartridges into the autoloader, prepare them as follows:

1. Affix the supplied bar code labels to the cartridges. Position each label in the indented area on the cartridge, as shown in [Figure 5-3](#). To prepare your own labels, refer to the *Exabyte Bar Code Label Specification for LTO Ultrium Cartridges* available at [www.exabyte.com/manuals](http://www.exabyte.com/manuals).

**Note:** The bar code labels provided with the autoloader include labels for both data cartridges and cleaning cartridges.

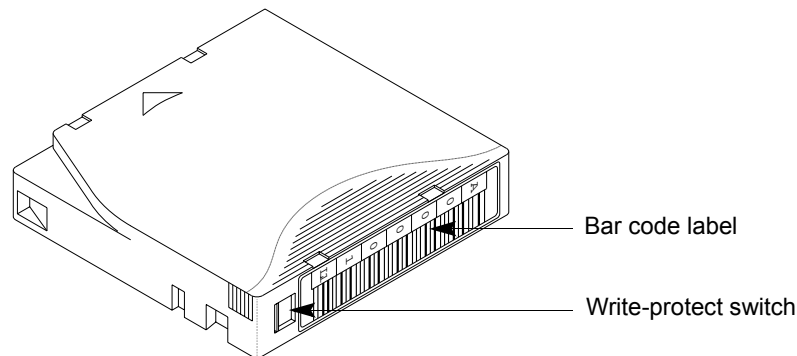

**Figure 5-3** Bar code label placement and write-protect switch location

2. Make sure the write-protect switch on each cartridge is set for the desired operation.

**If the switch...**

does not cover the opening

covers the opening

**the tape is...**

write-protected

write-enabled

## INSERTING CARTRIDGES INTO THE AUTOLOADER



To insert cartridges:

1. At the Home screen, press , , , or  to access the main menus.

If necessary, enter the operator panel password (see [page 42](#)).

2. Press  or  until the Command menu appears:

```
S e l e c t   a   C o m m a n d
```





3. Press  to see the menu selections, then press  or  until the following screen appears:

```
I m p o r t  
C a r t r i d g e s
```

4. Press  to display the cell selection screen:

```
I m p o r t   C a r t r i d g e  
T o   C e l l   #   n
```

The autoloader automatically selects the empty cell closest to the door.

5. Press  or  to scroll through the available (empty) cell locations to select a different cell.
6. Press  to start the import operation (or  to cancel the operation).

When the specified cartridge cell is in position at the cartridge access port, the door slides open and the following message appears:

```
L o a d   t a p e ,   l a b e l  
i n ,   p u s h   a n y   k e y
```

- a. Position the cartridge with the hub down and the bar code label and write-protect switch towards the door, as shown in [Figure 5-4](#).



**Caution**

Insert cartridges label-side first, as shown in Figure 5-4. Do not insert cartridges with the label and write-protect switch toward you. The arrow on the cartridge must face toward the outside.



**Figure 5-4** Inserting a cartridge into the autoloader

- b. Slide the cartridge fully through the access port until it snaps into place in the cartridge cell.
- c. Press any key. The door closes. The autoloader checks for the presence of a cartridge in the specified cell, makes sure that the cartridge is seated correctly, and updates the cartridge inventory. The cell selection screen appears again with the next available cell number:

```

I m p o r t   C a r t r i d g e
T o   C e l l   #   n

```

You can continue importing cartridges in the same manner until you have filled as many cells as you want.

---

**! Important** If you plan to store a cleaning cartridge in the autoloader, you must store it in cell 7.

---

7. Press  (as needed) to return to the Home screen.

## REMOVING CARTRIDGES FROM THE AUTOLOADER



To remove cartridges:

1. At the Home screen, press , , , or  to access the main menus.

If necessary, enter the operator panel password (see [page 42](#)).

2. Press  or  until the Command menu appears:





```
S e l e c t   a   C o m m a n d
```

3. Press  to see the menu selections.
4. Press  or  until the following screen appears:

```
E x p o r t  
C a r t r i d g e s
```

5. Press  to display the cell selection screen:

```
E x p o r t   C a r t r i d g e  
F r o m   C e l l   #   n
```

6. Press  or  to scroll through the occupied cell locations until the one you want appears.
7. Press  to start the export operation (or  to cancel the operation).

When the specified cartridge cell is in position at the cartridge access port, the door slides open and the following message appears:

```
R e m o v e   C a r t r i d g e  
P r e s s   A n y   K e y
```

- a. Reach through the access port, grasp the edge of the cartridge and pull it straight out of the autoloader.
- b. Press any button to close the door.

After the door closes, and the autoloader checks the cell to verify that the cartridge has been removed. The autoloader also scans the affected cell to update its cartridge inventory. The cell selection screen appears again with the next available cell number:

```

E x p o r t   C a r t r i d g e
F r o m   C e l l   #   n

```

You can continue removing cartridges in the same manner until you have removed as many cartridges as necessary.

8. Press  (as needed) to return to the Home screen.

## REMOVING CARTRIDGES WITHOUT POWER

If you need to remove cartridges from the autoloader when power is unavailable, either due to a general power failure or a failure of the autoloader's power supply, you can operate the cartridge access port door manually. The autoloader has a small hole in the faceplate that allows access to a gear shaft attached to the cartridge access port door (see [Figure 5-5](#)). Using a #0 Phillips screwdriver, you can turn the gear shaft to open the cartridge access port door.

**Note:** If a cartridge is loaded in the tape drive when power to the autoloader fails and you need to remove that cartridge, you must remove the tape drive from the autoloader (see [page 91](#) for instructions). If the autoloader's power supply failed, you can attach the tape drive to another power source, such as an available power connector in a server and use the tape drive's unload button to remove the cartridge. If a general power failure occurred, contact Exabyte Technical Support (see [page iii](#)) for information about removing the cartridge from the tape drive manually.



Access hole for operating the cartridge access port door

**Figure 5-5** Location of access hole for operating cartridge access port door manually

To remove cartridges from the autoloader without power:

1. Carefully insert a #0 Phillips screwdriver into the access hole on the front of the autoloader (see [Figure 5-5](#)). Make sure that the screwdriver engages the head of the gear shaft.
2. Turn the gear shaft counter-clockwise to open the cartridge access port door.
3. When the door is fully open, remove cartridges by hand from the autoloader. To move cartridge cells into position in front of the door, carefully rotate the cartridge carousel with your fingers.
4. When you are finished removing cartridges from the autoloader, close the cartridge access port door by turning the gear shaft clockwise.

## LOADING AND UNLOADING CARTRIDGES IN THE TAPE DRIVE

During normal operation, you do not need to instruct the autoloader to load and unload cartridges in the tape drive. Your backup software controls these functions. However, you can use the operator panel to load and unload cartridges, if necessary. You may want to use these functions for testing purposes or for cleaning the tape drive (see [page 73](#)).

### LOADING A CARTRIDGE INTO THE TAPE DRIVE

Before you can load a cartridge into the tape drive, the autoloader must already contain a cartridge or you must insert a cartridge through the cartridge access port, as described on [page 64](#).



To load a cartridge into the tape drive:

1. At the Home screen, press , , , or  to access the main menus.

If necessary, enter the operator panel password (see [page 42](#)).

2. Press  or  until the Command menu appears:





S e l e c t   a   C o m m a n d

3. Press  to see the menu selections.
4. Press  or  until the following screen appears:

L o a d   D r i v e

5. Press  to display the cell selection screen:

```
L o a d   D r i v e
F r o m   C e l l   #   n
```

6. Press  or  to scroll through the occupied cell locations until the one you want appears.
7. Press  to start the load operation (or  to cancel the operation).

When the specified cartridge cell is in position at the tape drive, the cartridge is loaded into the drive. A series of status messages appears during the operation, followed by the Command menu when the operation is complete.

8. Press  (as needed) to return to the Home screen.

## UNLOADING A CARTRIDGE FROM THE TAPE DRIVE



To unload a cartridge from the tape drive:

1. At the Home screen, press , , , or  to access the main menus.

If necessary, enter the operator panel password (see [page 42](#)).

2. Press  or  until the Command menu appears:



```
S e l e c t   a   C o m m a n d
```

3. Press  to see the menu selections.
4. Press  or  until the following screen appears:

```
U n l o a d   D r i v e
```

5. Press  to display the cell selection screen:

```
U n l o a d   D r i v e
I n t o   C e l l   #   n
```

The autoloader automatically selects the empty cell closest to the tape drive. If you want to unload the cartridge to a specific cell, press  or  to scroll through the available empty cell locations until the one you want appears.

**Note:** Normally, the empty cell closest to the tape drive is the same cell in which the cartridge was originally stored. If desired, you can unload a cartridge to different empty cell, if one is available.

6. Press  to start the unload operation (or  to cancel the operation).

When the tape drive ejects the cartridge, the autoloader places the cartridge in the specified cell. A series of status messages appears during the operation, followed by the Command menu when the operation is complete.

7. Press  (as needed) to return to the Home screen.

## CLEANING THE TAPE DRIVE

Under normal operating conditions, the LTO Ultrium tape drive in the autoloader does not require regular cleaning. The tape drive contains an automatic cleaning mechanism that allows it to clean itself as necessary. Occasionally, the tape drive may require cleaning with a cleaning cartridge. The tape drive monitors its cleaning needs internally and notifies the autoloader when it requires cleaning. When cleaning is required, the autoloader displays a cleaning message on the Status screen.



### Caution

Do not use any cleaning method other than the LTO Cleaning Cartridge (or a cleaning cartridge approved by Exabyte for use with LTO drives). Using other cleaning methods will void your warranty.

Carefully follow all instructions and recommendations provided with the cleaning cartridge. Do not rewind and reuse the material in a cleaning cartridge. Reusing the material may redistribute contaminants previously removed from the tape path. If all of the cleaning material has been used, discard the cartridge and use a new cleaning cartridge.

---

---

You can clean the tape drive in several ways:

<b>Use the autoloader's Autoclean function</b>	See <a href="#">page 32</a> for information about setting up automatic tape drive cleaning.
<b>Use your software's cleaning option</b>	Set the cleaning option in your software application (if available) so that the software monitors drive cleaning requirements and automatically cleans the tape drive using a cleaning cartridge stored in the autoloader. Refer to your software documentation for information about setting this option.
<b>Use the Clean Drive option from the autoloader's operator panel</b>	See <a href="#">"Cleaning the Tape Drive Using the Clean Drive Option"</a> on <a href="#">page 71</a> .
<b>Insert a cleaning cartridge through the autoloader's cartridge access port</b>	See <a href="#">"Cleaning the Tape Drive by Inserting a Cleaning Cartridge"</a> on <a href="#">page 73</a> .

Clean the tape drive whenever the autoloader displays the following message on the Home screen or whenever your application software notifies you. (Not all software applications display cleaning requirements.)

```
L T O   1 x 7   2 U
D : N e e d s   C l e a n i n g
```

## CLEANING THE TAPE DRIVE USING THE CLEAN DRIVE OPTION



Before using the Clean Drive option, make sure that:

- ▶ A cleaning cartridge is stored in cell 7 (see [page 62](#)).
- ▶ You have activated the cleaning cartridge cell, which designates cell 7 as the storage location for the cleaning cartridge (see [page 33](#)).
- ▶ You have turned the Autoclean option OFF (see [page 34](#)).



When the tape drive requires cleaning:

1. At the Home screen, press , , , or  to access the main menus.

If necessary, enter the operator panel password (see [page 42](#)).

2. Press  or  until the Command menu appears:

S e l e c t   a   C o m m a n d

3. Press  to see the menu selections, then press  or  until the following screen appears:

C l e a n   D r i v e ?

4. Press . A confirmation message appears:

S t a r t   C l e a n i n g  
D r i v e   N o w ?

If the cleaning cell is empty, you are prompted to insert a cleaning cartridge. Follow the on-screen instructions to insert a cleaning cartridge.

**Note:** If you have not activated the cleaning cell, an error message appears. Activate the cleaning cell, as described on [page 33](#), and begin the cleaning process again.

5. Press  to begin the cleaning operation (or  to cancel the operation).

The autoloader moves the cleaning cartridge to the tape drive and loads it. After the cleaning is complete (in less than a minute), the tape drive ejects the cleaning cartridge. If the cleaning was successful, the autoloader returns the cleaning cartridge to its cell.

6. Confirm that the cleaning completed successfully by looking at the operator panel. The cleaning message should be gone. If the cleaning was not successful, a message explaining the failure appears on the screen. You may be prompted to insert a new cleaning cartridge.

---

**!** **Important** If there are no more cleaning cycles remaining on the cleaning cartridge, the tape drive ejects the cartridge immediately without performing the cleaning. Remove the cleaning cartridge from the autoloader and use a new one. **Do not rewind and reuse the material in a cleaning cartridge. Reusing the material may redistribute contaminants previously removed from the tape path.**

---

7. Press  (as needed) to return to the Home screen.



## CLEANING THE TAPE DRIVE BY INSERTING A CLEANING CARTRIDGE

Use this method if you don't want to store a cleaning cartridge in the autoloader.

**Note:** If you are using all 7 cells in the autoloader for data cartridges, you will need to remove a data cartridge to make room for the cleaning cartridge.

Before cleaning the tape drive by inserting a cleaning cartridge through the cartridge access port, make sure that you have turned the Autoclean option OFF (see [page 34](#)).

When the tape drive needs cleaning:

1. If you have data cartridges in all 7 cells, use the Export Cartridge command to remove a cartridge from the autoloader, as described on [page 66](#). Before pressing a button to close the door, insert the cleaning cartridge. Then, press any button.

**Note:** If you do not need to export a cartridge to make room for the cleaning cartridge, use the Import Cartridge command to insert the cleaning cartridge into the autoloader, as described on [page 64](#).

2. Use the Load Drive command to load the cleaning cartridge into the tape drive, as described on [page 68](#).

The tape drive automatically performs the cleaning in less than a minute and ejects the cartridge when finished. Confirm that the cleaning completed successfully by looking at the operator panel. The cleaning message should be gone. If the cleaning was not successful, a message explaining the failure appears on the screen. You may be prompted to insert a new cleaning cartridge.

---

**! Important** If there are no more cleaning cycles remaining on the cleaning cartridge, the tape drive ejects the cartridge immediately without performing the cleaning. Remove the cleaning cartridge from the autoloader and use a new one. **Do not rewind and reuse the material in a cleaning cartridge. Reusing the material may redistribute contaminants previously removed from the tape path.**

---

3. Use the Unload Drive command to return the cleaning cartridge to its cell.
4. Use the Export Cartridge command to remove the cleaning cartridge from the autoloader, as described on [page 66](#). Before pressing a button to close the door, insert the data cartridge you removed previously (if applicable). Then, press any button to close the door.
5. Press  (as needed) to return to the Home screen.

## RESETTING THE AUTOLOADER

If the autoloader or tape drive has encountered an error and is not operating as expected after you have tried the recommended corrective actions, you may need to perform a reset. From the operator panel, you can reset the autoloader without resetting the tape drive. You can reset both the autoloader and the tape drive by powering the autoloader off and back on.

**Note:** You may also be able to perform resets from your autoloader software. Refer to your software documentation for instructions.

Resetting the autoloader from the operator panel or powering the autoloader off and back on causes it to perform its power-on self-test and a cartridge inventory. Powering the autoloader off and back on to reset the tape drive causes the tape drive to perform its power-on self-test and to rewind a loaded tape to the beginning.

---

**! Important** If you need to power the autoloader off, first unload the cartridge from the tape drive, if possible. If you power the autoloader off and back on while a cartridge is in the tape drive, the drive may have to perform a lengthy format recovery process.

If a cartridge is loaded in the tape drive when the autoloader is powered off and back on, the tape drive rewinds the tape but does not eject the cartridge. Make sure that it is safe to overwrite the tape before performing a backup so that you don't lose previously recorded data. If necessary, unload the cartridge as described on [page 69](#).

---

To reset the autoloader from the operator panel:

---

**! Important** Before resetting, make sure that the autoloader or tape drive is not communicating across the bus. The reset may disrupt communications on the bus.

---

1. At the Home screen, press , , , or  to access the main menus.

If necessary, enter the operator panel password (see [page 42](#)).

2. Press  or  until the Diagnostic menu appears:

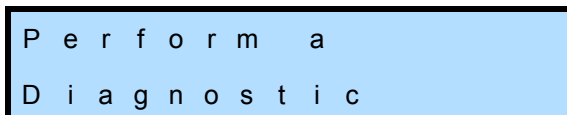

P e r f o r m a  
D i a g n o s t i c

3. Press to see the menu selections, then press or until the following screen appears:

R e s e t   L i b r a r y ?

4. Press . A confirmation message appears:

R e s e t   t h e  
L I B R A R Y   N o w ?

5. Press to begin the reset (or to cancel the reset).

The autoloader resets and performs a cartridge inventory. When the reset is complete, the Home screen appears.

## RUNNING SYSTEM DEMOS

The autoloader has a built-in demo program that can be used for testing or demonstrating autoloader operation. When performing its demo program, the autoloader loops through the following functions:

- ▶ Positions a cartridge cell in front of the tape drive.
- ▶ If the cell contains a cartridge, moves the cartridge to the tape drive.
- ▶ If the Load option (described in this section) is on:
  - ▶ Inserts the cartridge into the tape drive.
  - ▶ Waits for the tape to be loaded.
  - ▶ Instructs the tape drive to unload and eject the cartridge.
- ▶ Returns the cartridge to its cell.
- ▶ Repeats until any front panel button is pressed.



To run the autoloader demo:

1. At the Home screen, press , , , or to access the main menus.

If necessary, enter the operator panel password (see [page 42](#)).

2. Press or until the Diagnostic menu appears:

P e r f o r m   a  
D i a g n o s t i c

- Press  to see the menu selections, then press  or  until the following screen appears:



```
R u n   S y s t e m   D e m o ?
```

- Press . The following screen appears:

```
S e t   L o a d   O p t i o n
O F F   N o w ?
```

- Press  or  to switch between OFF and ON. If you want cartridges loaded into the tape drive during the demo, select ON. If not, select OFF.
- Press . A confirmation message appears:

```
S t a r t   D e m o   N o w ?
```

- Press  to start the demo (or  to cancel the demo). The autoloader begins the demo and displays a status screen:

```
D E M O :
n n n n   M O V E   n n
```

The number on the left indicates the total number of moves that have taken place. The number on the right indicates which cartridge is currently being positioned at, loaded, or unloaded from the tape drive. The text reads MOVE, LOAD, or UNLOAD, depending on the operation being performed.

- To stop the demo, press any button. The LCD displays the Home screen.

**Note:** If a cartridge is in the tape drive when you stop the demo, the cartridge is unloaded.



## PERFORMING DIAGNOSTIC TESTS

To check basic autoloader functions, you can run a set of diagnostic tests from the operator panel. These tests check the autoloader's internal memory, voltages, and SCSI functions. If you report a problem to Exabyte Technical Support, you may be asked to run these tests and provide the results.



To run the autoloader's diagnostic tests:

1. At the Home screen, press , , , or  to access the main menus.

If necessary, enter the operator panel password (see [page 42](#)).

2. Press  or  until the Diagnostic menu appears:

```
P e r f o r m a
D i a g n o s t i c
```

3. Press  to see the menu selections, then press  or  until the following screen appears:

```
R u n   h a r d w a r e
s e l f t e s t ?
```

4. Press . A confirmation message appears:

```
S t a r t   h a r d w a r e
s e l f t e s t   n o w ?
```

5. Press  to start the test (or  to cancel the test).

The test begins. When the test is finished, the following screen appears:

```
H / W   s e l f t e s t
p a s s e d .
```

6. Press  (as needed) to return to the Home screen.

## STORING CARTRIDGES

Whenever you remove cartridges from your autoloader, be sure to store them properly to maximize archival life and ensure data integrity. Follow these guidelines for proper cartridge storage:

- ▶ **Store cartridges in a suitable environment.** Follow the specifications for storage temperature and other environmental requirements, as described on the cartridge packaging. Do not allow the temperature and humidity in the storage environment to fluctuate.
- ▶ **Store cartridges with the write-protect switch in the protected position.** (See [page 63](#).)
- ▶ **Keep the storage location as free of airborne particulates as possible.** To eliminate obvious sources of particulates, do not permit anyone to smoke, eat, or drink near the storage area, and do not store cartridges near a copier or printer that may emit toner and paper dust.
- ▶ **Store cartridges as soon as possible after you remove them from the autoloader.** Immediate storage helps avoid many of the conditions that can damage tapes, such as temperature and humidity fluctuations, particulate contamination, and excessive handling.

# 6

## VIEWING AUTOLOADER INFORMATION







The autoloader maintains an internal database containing extensive information about its configuration and operations. This information is available through the operator panel. During day-to-day operation, you typically do not need to access this information. However, if you need to contact Exabyte Technical Support about your autoloader, you may be asked to check and report back on various settings and event results.

This chapter explains how to view the following:

- ▶ Autoloader information – code version, serial number, SCSI ID, statistics, network addresses, and operating mode
- ▶ Autoloader sensor readings
- ▶ Tape drive information – code version, serial number, and SCSI ID
- ▶ Cartridge inventory and bar code information
- ▶ Cell statistics
- ▶ Event log



### VIEWING BASIC AUTOLOADER INFORMATION

To check the autoloader's firmware code version, serial number, SCSI ID, statistics, network addresses, and operating mode:

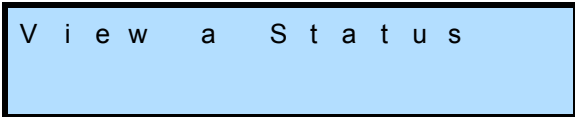
1. At the Home screen, press , , , or  to access the main menus.  
If necessary, enter the operator panel password (see [page 42](#)).
2. Press  or  until the Status menu appears:



V i e w   a   S t a t u s

3. Press  to see the menu selections, then press  or  until the following screen appears:

```
V i e w   L i b r a r y
I n f o r m a t i o n ?
```

4. Press . The firmware screen appears:

```
L i b r a r y   F W   l e v e l
n n n n n n n n n n n n
```

- a. Press . The serial number screen appears:

```
L i b r a r y   S e r i a l # :
n n n n n n n n n n n n
```

- b. Press . The SCSI ID screen appears:

```
L i b r a r y   c u r r e n t
S C S I   I D :      n
```

- c. Press . The total loads screen appears:

```
T o t a l   L o a d s :
n n n n n n n n
```

This screen indicates the total number of times the cartridge loader has loaded a cartridge into the tape drive.

- d. Press . The total load retries screen appears:

```
T o t . L o a d   R e t r i e s
n n n n n n
```

This screen indicates the total number of times the cartridge loader has had to retry loading a cartridge into the tape drive.



- e. Press . The total moves screen appears:

```
T o t a l   M o v e s :
n n n n n n n n n n
```

This screen indicates the total number of moves that have taken place in the autoloader. A move is when the cartridge loader removes a cartridge from its cell and places it in the tape drive or removes a cartridge from the tape drive and places it in its cell.

- f. Press . The total move retries screen appears:

```
T o t . M o v e   R e t r i e s
n n n n n n n n n n
```

This screen indicates the total number of times the autoloader has had to retry a move operation.

- g. Press . The DHCP screen appears. If DHCP addressing is on (see [page 35](#)), this screen indicates the current server-assigned IP address for the autoloader:

```
D H C P   a d d r e s s   i s :
n n n . n n n . n n n . n n n
```

If DHCP addressing is off, the following screen appears:

```
D H C P   i s   O F F .
N o   D H C P   a d d r e s s .
```

- ▶ Press  to view the IP address. A screen similar to the following appears:

```
I P   a d d r e s s   i s :
0 0 0 . 0 0 0 . 0 0 0 . 0 0 0
```

- ▶ Press  to view the Subnet address. A screen similar to the following appears:

```
S u b n e t   a d d r .   i s :
0 0 0 . 0 0 0 . 0 0 0 . 0 0 0
```

- ▶ Press  to view the Gateway address. A screen similar to the following appears:

```
G a t e w a y   a d d r . i s :
0 0 0 . 0 0 0 . 0 0 0 . 0 0 0
```

- h. Press . The Restore Default screen appears.

```
R e s t o r e   D e f a u l t
n n n n n n n n n n n n n
```

- i. Press . The operating mode screen appears. If the autoloader is operating in Random mode, the following screen appears:

```
O p e r a t i n g   m o d e
i s   R a n d o m
```

If the autoloader is operating in sequential mode (see [page 38](#)), the following screen appears:

```
O p e r a t i n g   m o d e
i s   S e q u e n t i a l .
```

Press  to view the setting of the Restart and Loop options (described on [page 38](#)). If the autoloader is in sequential mode, a screen similar to the following appears:

```
R e s t a r t   i s   O N .
L o o p i n g   i s   O N .
```



- 5. Press  (as needed) to return to the Home screen.

## VIEWING AUTOLOADER SENSOR READINGS



To check the autoloader's sensor readings:

1. At the Home screen, press , , , or  to access the main menus.

If necessary, enter the operator panel password (see [page 42](#)).

2. Press  or  until the Status menu appears:

V i e w   a   S t a t u s

3. Press  to see the menu selections, then press  or  until the following screen appears:

V i e w   S e n s o r s  
I n f o r m a t i o n ?

4. Press . The door open sensor screen appears:

D o o r   O p e n   s e n s o r  
i s   O f f .

This screen indicates the current reading of the Door Open sensor for the cartridge access port door:

- ▶ On—door completely open
- ▶ Off—door not completely open

- a. Press . The door closed sensor screen appears:

D o o r   C l o s e d  
s e n s o r   i s   o n .

This screen indicates the current reading of the Door Closed sensor for the cartridge access port door:

- ▶ ON—door completely closed
- ▶ OFF—door not completely closed

- b. Press . The eject sensor screen appears:

E j e c t   S e n s o r  
i s   o n .

This screen indicates the current reading of the Eject sensor at the tape drive:

- ▶ ON—a cartridge is ejected
- ▶ OFF—a cartridge is not ejected

- c. Press . The cell sensor screen appears:

```
C e l l   S e n s o r
i s   o f f .
```

This screen indicates the current reading of the Cell sensor:

- ▶ On—the cartridge in front of the door is incorrectly positioned
- ▶ Off—the cartridge is correctly positioned

- d. Press . The library temperature screen appears:

```
L i b r a r y   T e m p .
i s   n o r m a l .
```

This screen indicates the current status of the Library Temperature sensor:

- ▶ Normal—the internal temperature of the autoloader is within the normal operating range
- ▶ Too High—the internal temperature of the autoloader is above the normal operating range

If the sensor indicates that the temperature is too high, check that the fans are operating. If possible, provide additional cooling air circulation around the autoloader. Contact Exabyte Technical Support (see [page iii](#)) if your autoloader experiences problems.

- e. Press . The system fan status screen appears:

```
S y s t e m   f a n
i s   r u n n i n g .
```

This screen indicates the current status of the autoloader's main cooling fan:

- ▶ Running—the system fan is operating normally
- ▶ Has stopped—the system fan is not operating

Contact Exabyte Technical Support (see [page iii](#)) if your autoloader experiences problems.

- f. Press . The power supply fan status screen appears:

```
P o w e r   s u p p l y   f a n
i s   r u n n i n g .
```

This screen indicates the current status of the autoloader's power supply fan:

- ▶ Running—the power supply fan is operating normally
- ▶ Has stopped—the power supply fan is not operating

Contact Exabyte Technical Support (see [page iii](#)) if your autoloader experiences problems.



5. Press  (as needed) to return to the Home screen.

## VIEWING BASIC TAPE DRIVE INFORMATION



To check the tape drive's firmware code version, serial number, and SCSI ID:

1. At the Home screen, press , , , or  to access the main menus.

If necessary, enter the operator panel password (see [page 42](#)).

2. Press  or  until the Status menu appears:

```
V i e w   a   S t a t u s
```

3. Press  to see the menu selections, then press  or  until the following screen appears:

```
V i e w   D r i v e
I n f o r m a t i o n ?
```

4. Press . The firmware screen appears:

```
D r i v e   F W   l e v e l
n n n n n n n n n n n n n n
```

- a. Press . The serial number screen appears:

```
D r i v e   S e r i a l #   :
n n n n n n n n n n n n n n
```

- b. Press . The SCSI ID screen appears:

```

D r i v e   c u r r e n t
S C S I   I D :           n

```

5. Press  (as needed) to return to the Home screen.

## VIEWING THE CARTRIDGE INVENTORY AND BAR CODE INFORMATION

The autoloader maintains a cartridge inventory to keep track of where cartridges are located. In performing an inventory, the autoloader checks for cartridges in the cells and scans each cartridge's bar code label. The autoloader uses this information to process commands from an application.



### VIEWING THE CARTRIDGE INVENTORY

A cartridge inventory is automatically performed each time the autoloader is powered on, each time a cartridge is inserted or removed from the autoloader, and each time a cartridge is loaded or unloaded from the tape drive. You can view the cartridge inventory to quickly determine which cells contain cartridges and whether a cartridge is loaded in the tape drive.

To view the cartridge inventory:

1. At the Home screen, press , , , or  to access the main menus.



If necessary, enter the operator panel password (see [page 42](#)).

2. Press  or  until the Status menu appears:

```

V i e w   a   S t a t u s

```

3. Press  to see the menu selections, then press  or  until a screen similar to the following appears:

```

V i e w   I n v e n t o r y :
- 2 3 4 5 6 7                D

```

The numbers in the second line of the screen correspond to cartridge cells.

If this appears...	The cell...
A number (1, 2, 3)	contains a cartridge
A dash (-)	is empty

The character at the right indicates whether the tape drive contains a cartridge.

If this appears...	The tape drive...
D	contains a cartridge
A dash (-)	is empty



In the example above, all of the cells except cell 1 contain cartridges. The cartridge from cell 1 is loaded in the tape drive.

- Press . The bar code information screen appears:

```

C e l l #   n   B a r c o d e
n n n n n n n n
  
```

This screen shows the contents of the bar code label.

- Press  or  until the number of the cell you want appears.
- Press  (as needed) to return to the Home screen.



## UPDATING THE CARTRIDGE INVENTORY

Although the autoloader maintains its cartridge inventory automatically, you can issue an operator panel command to update the inventory at any time. For example, you might want to update the inventory if the bar code scanner has had a problem reading a bar code label. If the bar code label screen indicates all blanks for a label, you may want to have the autoloader re-do the cartridge inventory to see if it can read the label. If the problem still exists, the label may need to be replaced.

To update the cartridge inventory:



- At the Home screen, press , , , or  to access the main menus.

If necessary, enter the operator panel password (see [page 42](#)).

- Press  or  until the Command menu appears:

```

S e l e c t   a   C o m m a n d
  
```

3. Press  to see the menu selections, then press  or  until a screen similar to the following appears:

```
U p d a t e   I n v e n t o r y
1 2 3 4 5 6 7           -
```

4. Press . The autoloader scans each of the cartridge cells and updates the cartridge inventory. When the operation is finished, the new inventory appears on the screen:

```
N e w   I n v e n t o r y :
1 2 3 4 5 6 7           -
```

5. Press  (as needed) to return to the Home screen.



## VIEWING CELL STATISTICS

The autoloader maintains statistics on each cartridge cell, including how many times a cartridge has been placed and picked from the cell and how many times the autoloader had to retry a place or pick operation.



To view the cell statistics:

1. At the Home screen, press , , , or  to access the main menus.

If necessary, enter the operator panel password (see [page 42](#)).

2. Press  or  until the Status menu appears:



```
V i e w   a   S t a t u s
```

3. Press  to see the menu selections, then press  or  until the following screen appears:

```
V i e w   a   C e l l
I n f o r m a t i o n ?
```

4. Press . The cell selection screen appears:

```
V i e w   I n f o r m a t i o n
f o r   C e l l   #   1
```

5. Press  or  until the number of the cell you want appears.



6. Press . The total puts screen appears:

```
C e l l #   n       P u t s
n n n n n n n n
```

This screen indicates the total number of times a cartridge has been placed (put) into this cell.

- a. Press . The put retries screen appears:

```
# n       P u t   R e t r i e s
n n n n n n
```

This screen indicates the total number of times the autoloader had to retry a put operation at this cell.

- b. Press . The total picks screen appears:



```
C e l l #   n       P i c k s
n n n n n n n n n n
```

This screen indicates the total number of times a cartridges has been picked from this cell.

- c. Press . The pick retries screen appears:

```
# n       P i c k   R e t r i e s
n n n n n n
```

This screen indicates the total number of times the autoloader had to retry a pick operation at this cell.

- d. Press . The next cell selection screen appears. If you want to continue viewing statistics for other cells, return to step 5.
7. Press  (as needed) to return to the Home screen.



## VIEWING THE EVENT LOG

The event log lists any events that prevent an autoloader operation from completing (up to 10 events). If you contact Exabyte Technical Support, you may be asked to check this history buffer to help troubleshoot a problem.



To view the event log:

1. At the Home screen, press , , , or  to access the main menus.

If necessary, enter the operator panel password (see [page 42](#)).

2. Press  or  until the Status menu appears:

```
V i e w   a   S t a t u s
```



3. Press  to see the menu selections, then press  or  until the following screen appears:

```
V i e w   E v e n t   L o g
T o t a l   E v e n t s   n n
```

4. Press . The most recent event appears, such as the following example:

		Initiator		Failed command
Log entry		↓		↓
	#	1	, P ,	U N L O A D
Failure code				D r i v e   i s   E m p t y

Initiator: P = Panel, S = SCSI Bus

5. Press  or  to scroll through the events in the log, as necessary.
6. Press  (as needed) to return to the Home screen.

# 7

## MAINTENANCE

This chapter describes basic autoloader maintenance tasks that you can perform on-site without the aid of a service technician. These tasks include:

- ▶ Replacing the tape drive
- ▶ Cleaning the autoloader
- ▶ Upgrading autoloader firmware and creating diagnostic listings via FTP
- ▶ Upgrading autoloader firmware and creating diagnostic listings using Exabyte LibTool
- ▶ Upgrading tape drive firmware and creating diagnostic listings using Exabyte LTOTool.



### Caution

Do not attempt to replace any components in the autoloader, other than the tape drive. If you do so, you will void your warranty.

---

---

## REPLACING THE TAPE DRIVE

This section describes how to replace the autoloader's tape drive. You can order a new tape drive from Exabyte (see [page iii](#)) or from your supplier.

---

**! Important** New tape drives must be specially configured for use in the autoloader and must therefore be ordered directly from Exabyte or from an Exabyte-approved supplier.

You must replace the installed tape drive with the same configuration tape drive, as follows:

- Full height to full height
- or-
- Half height to half height

You cannot replace a full height with a half height, or vice versa.

---

## PREPARING FOR REPLACEMENT

**Note:** If your autoloader is installed in a rack, it is not necessary to remove the autoloader from the rack to replace the tape drive. It is also not necessary to disconnect the SCSI cable, terminator, or Ethernet cable from the back of the autoloader as long as they do not interfere with your access to the tape drive.

To prepare for replacement:

1. **Obtain these tools:** a #1 Phillips screwdriver, a #2 Phillips screwdriver, and a small flat-blade screwdriver.
2. **Ensure that the environment is free of conditions that could cause electrostatic discharge (ESD).** If possible, use an antistatic mat and a grounded static protection wristband during installation. If a mat and wristband are not available, touch a known grounded surface, such as a computer's metal chassis.
3. **Power off the autoloader** (press the 0 on the back of the autoloader) **and disconnect the power cord.**



### Warning

Before performing any installation or maintenance procedures, be sure that the autoloader's power switch is off and that the power cord is disconnected from the autoloader and the outlet.

---



### Warnung

Vor der Ausführung von Installations- oder Wartungsarbeiten ist darauf zu achten, daß der Autoloader-Netzschalter auf "Aus" gestellt ist und daß das Anschlußkabel vom Autoloader und der Steckdose entfernt ist.

---



### Advertencia

Antes de realizar cualquier procedimiento de instalación o de mantenimiento, comprobar que el interruptor de alimentación de la biblioteca está apagado y que el cable de alimentación no está enchufado ni a la biblioteca ni a la toma de corriente.

---

## REMOVING THE TAPE DRIVE

To remove the tape drive from the autoloader:

1. **Remove the tape drive cover plate**—Locate the tape drive cover plate at the back of the autoloader (see [Figure 7-1](#)).

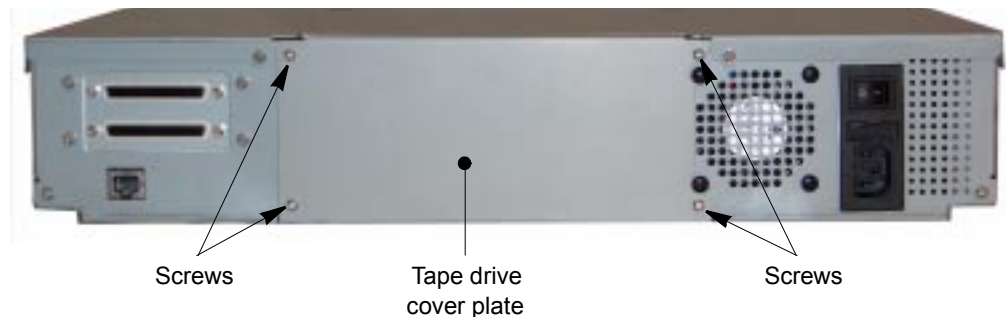

**Figure 7-1** Location of tape drive cover plate

- a. Using a #1 Phillips screwdriver, remove the four screws securing the cover plate (see [Figure 7-1](#)).
- b. Remove the cover plate and set it and screws aside. Use the small flat blade screwdriver to gently pry the cover off, if necessary.

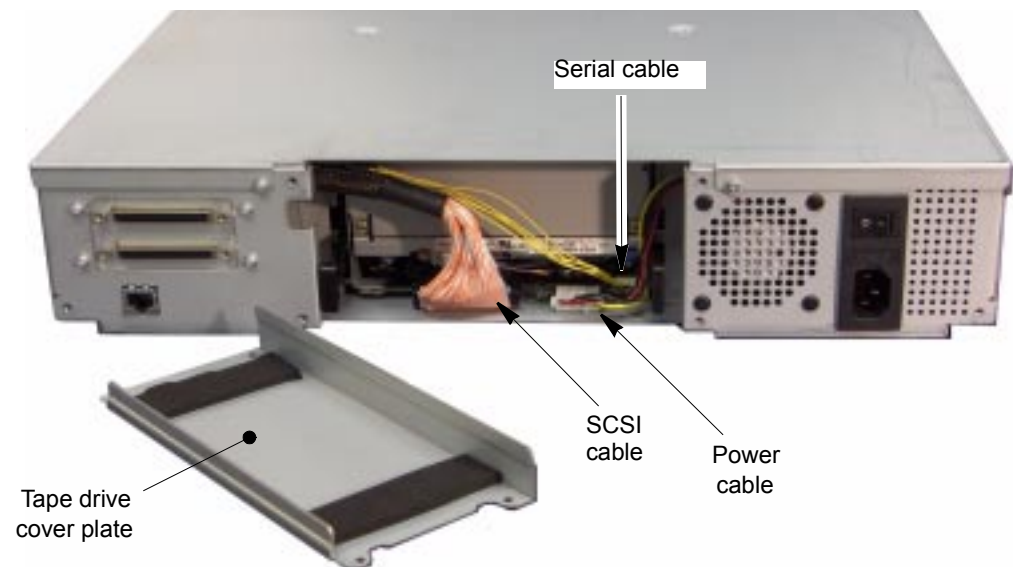
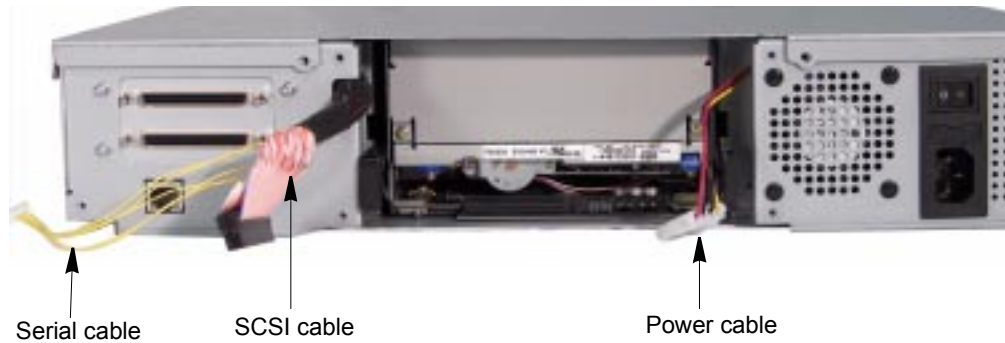

**Figure 7-2** Removing the tape drive cover plate to expose the drive cables

**Note:** The figures show the autoloader with a full height tape drive installed. Follow the same steps for a half height configuration.

2. **Disconnect the cables**—Disconnect the power cable, SCSI cable, and serial cable from the tape drive (see [Figure 7-3](#)).
  - a. Route the SCSI cable into the cut-out in the left side of the opening.

- b. Route the remaining cables toward the sides of the opening, away from the sides of the tape drive.



**Figure 7-3** Disconnecting the cables from the tape drive

3. **Remove the tape drive**—Pull the tabs on the tape drive brackets and slide the tape drive straight out of the autoloader.

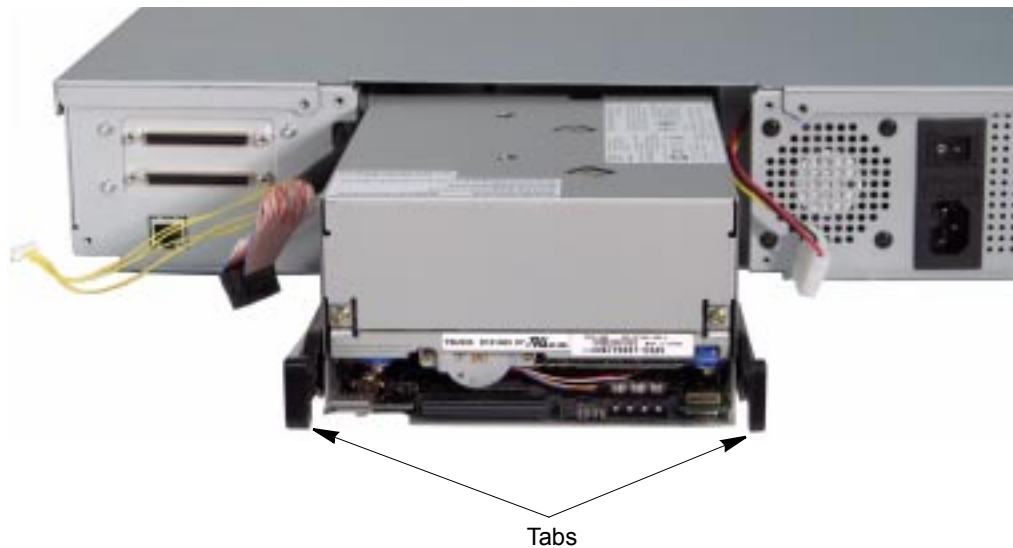

**Figure 7-4** Removing the tape drive

4. **Remove the brackets**—Follow these instructions to remove the brackets.
- ▶ **Half height tape drive:** Note the orientation of the brackets, then using a #1 Phillips screwdriver, remove the two screws from each of the brackets attached to the tape drive. Save the brackets and screws to attach to the new tape drive.

- ▶ **Full height tape drive:** Note the orientation of the brackets, then using a #1 Phillips screwdriver, remove the two screws from each of the brackets attached to the tape drive (see [Figure 7-5](#)). Save the brackets and screws to attach to the new tape drive.



**Figure 7-5** Removing the brackets from the tape drive

## INSTALLING THE NEW TAPE DRIVE

- 
- ! **Important** The replacement tape drive must be preconfigured for use in the autoloader. Purchase replacement tape drives from Exabyte or an Exabyte-approved supplier.
- 

To install the new tape drive:

1. **Remove the faceplate**—Follow these steps to remove the faceplate.

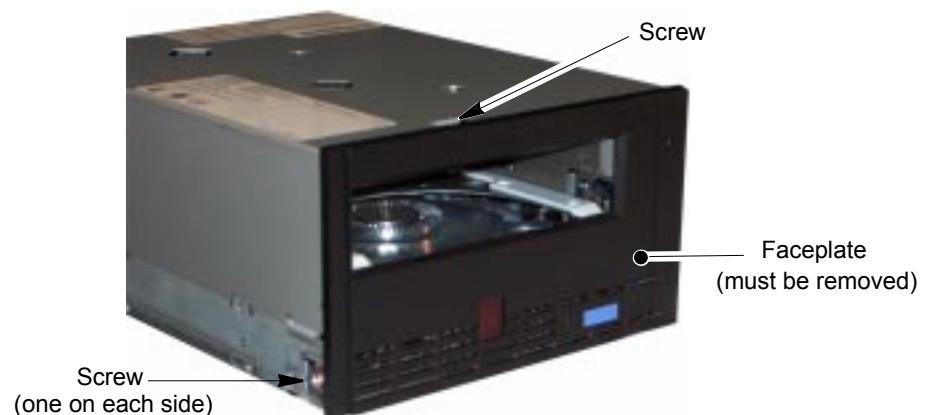

**Figure 7-6** LTO full height tape drive with faceplate

- a. Using a #2 Phillips screwdriver, remove the three screws securing the face plate to the tape drive chassis (see [Figure 7-6](#)).

- b. Carefully pull the faceplate straight off the tape drive chassis. You may need to press the unload button to disengage it from the front of the tape drive (see [Figure 7-7](#)).



**Figure 7-7** Removing the faceplate from the tape drive chassis

2. **Attach the brackets**—Place the tape drive right side up on the work surface (the product labels on the tape drive are on the top).

---

**! Important** The screws are *not* interchangeable. The LTO-2 tape drive uses 6-32 x 1/4 pan head phillips screws; the LTO-3 uses M3 x 5.5 PH phillips screws.

---

**! Tip** The embossed arrow on the end of each bracket points up.





- ▶ **Half height tape drive:** Place the brackets you removed from the original half height tape drive on the new half height tape drive. Attach the “thick” bracket on the right side of the tape drive—as viewed from the back of the tape drive.

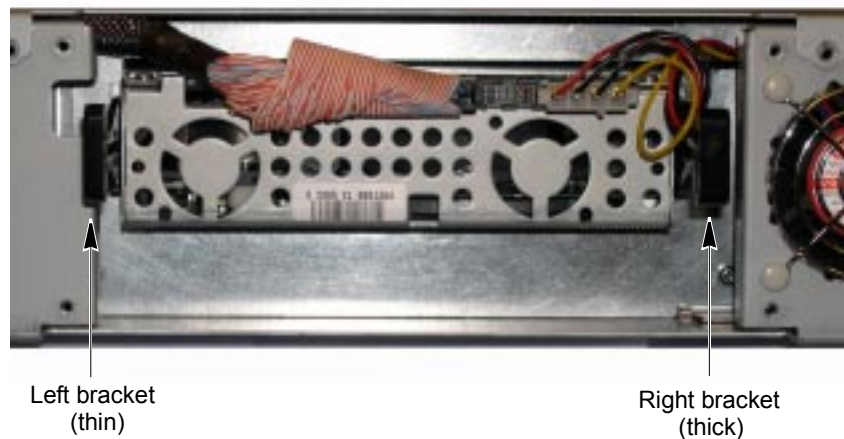

**Figure 7-8** Attaching the brackets to a half height tape drive

**Note:** Make sure that the edges of the brackets are parallel to the edges of the tape drive (not at an angle).

- ▶ **Full height tape drive:** Place the brackets you removed from the original full height tape drive on the new full height tape drive. See [Figure 7-9](#) for the proper orientation. Attach the “thin” bracket on the right side of the tape drive—as viewed from the back of the tape drive.



**Figure 7-9** Attaching the brackets to a full height tape drive

**Note:** Make sure that the edges of the brackets are parallel to the edges of the tape drive (not at an angle).

3. **Install the tape drive**—With the tape drive right side up, slide it into the autoloader as far as it will go without force.

---

**! Important** You must replace the installed tape drive with the same configuration tape drive. You cannot replace a full height tape drive with a half height tape drive, or vice versa.

---

- ▶ **Half height tape drive**—Install in opening. Do NOT remove air block plate.

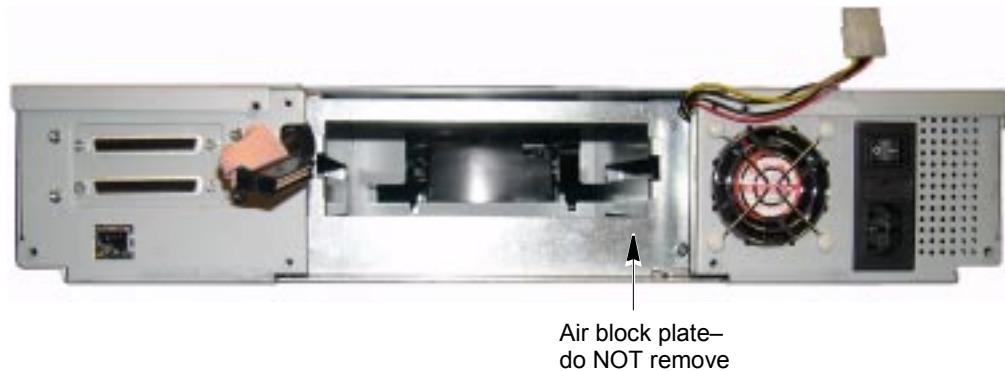

*Figure 7-10 Half height tape drive installation*

- ▶ **Full height tape drive**—Install as shown.



*Figure 7-11 Full height tape drive installation*

4. **Connect the cables**—Follow these steps to connect the cables.
  - a. Connect the serial cable to the tape drive (see [Figure 7-2](#)). The connector is keyed to ensure the proper orientation.



**Caution**

Before connecting the SCSI cable in the following step, make sure that none of the pins in the connector are bent.

---



---

- b. Connect the SCSI cable and power cable to the tape drive. The connectors are keyed to ensure the proper orientation.
- c. Route the cables so that they don't hang below the bottom edge of the tape drive (see [Figure 7-2](#)).

5. **Complete the installation**—With the wide edge of the tape drive cover plate toward the bottom, slide the cover plate over the opening in the autoloader's back panel (see [Figure 7-1](#)). Make sure that the cables aren't pinched by the cover plate. Insert and tighten the four screws.

## RESUMING OPERATION

To resume operation:

1. If you disconnected the SCSI cable, terminator, or Ethernet cable from the autoloader, reconnect them.
2. Reconnect the power cord and power on the autoloader, as described on [page 19](#).

The autoloader is now ready to resume operation. The new tape drive automatically assumes the SCSI ID of the old tape drive.

You may want to perform a few cartridge load and unload operations from the front panel to ensure that the autoloader and the newly installed tape drive are communicating correctly (see [page 68](#)). You may also want to back up several megabytes of data with the new tape drive and perform a comparison check on the backed-up data. This determines whether the software and tape drive are communicating properly.

## CLEANING THE AUTOLOADER



### Caution

The autoloader's internal components are lubricated at the factory and should not be cleaned or relubricated.

The only autoloader components that should be cleaned are the tape drive and the operator panel.

- ▶ Instructions for cleaning the tape drive are provided on [page 70](#).
- ▶ To clean the LCD, use wipes or cleaners appropriate for LCD screens or computer monitors.



### Caution

To avoid scratching the LCD, do not use abrasive cleaners, abrasive cleaning implements, harsh chemicals, or solvents.

## FTP—AUTOLOADER FIRMWARE UPGRADE AND DIAGNOSTICS

Occasionally, Exabyte makes revisions to the autoloader's internal code (firmware). The autoloader's Remote Management utility contains additional firmware for the Ethernet module, which is also revised periodically.

This section describes how to connect the autoloader to a host computer and use an FTP utility to upgrade autoloader firmware and create diagnostic listings.

**Note:** If you don't want to use the autoloader's Remote Management utility, see [page 102](#) for information about using Exabyte LibTool to upgrade firmware and create diagnostic listings over the SCSI interface.

- ▶ Downloading firmware—You can download new firmware from [www.exabyte.com/downloads](http://www.exabyte.com/downloads). To upload new firmware to the autoloader, you can use the autoloader's optional Ethernet interface and an FTP utility.
- ▶ Creating a diagnostic listing—If you report a problem to Exabyte Technical Support, you may be asked to create a diagnostic listing (also called a *dump*) via FTP. A diagnostic listing is created when you use an FTP utility to send a copy of the autoloader's diagnostic buffer to a host computer. This information can be used by support personnel to troubleshoot incidents with the autoloader.

### CONNECTING TO THE AUTOLOADER'S FTP INTERFACE

To use an FTP utility with the autoloader, you must have the following:

- ▶ A Category 5 (100BaseT connection) data-grade cable
- ▶ Software that supports RFC 959 file transfer protocol
- ▶ A host computer or network connection that uses a pin-through-hole RJ-45 shielded Ethernet connector

To access the autoloader's FTP interface:

1. Connect the Ethernet cable as described on [page 18](#), and set Ethernet configuration options as described on [page 35](#). Make a note of the autoloader's IP address.  
  
**Note:** If you set DHCP on, you can view the current server-assigned IP address for the autoloader through the Status menu (see [page 79](#)).
2. From your host computer, activate the FTP utility you are going to use. Connect to the autoloader using the autoloader's current IP address.
3. Log into the autoloader's FTP interface using the autoloader's FTP default user name and password:

User name: anonymous  
Password: Exabyte

**Note:** The user name and password are case-sensitive. If desired, you can change the user name and password from their defaults through the autoloader's Remote Management utility (see [Chapter 4](#)).

## UPGRADING AUTOLOADER FIRMWARE VIA FTP

To upgrade the autoloader's firmware via FTP:

1. Obtain new firmware for the autoloader. You can download new firmware from [www.exabyte.com/downloads](http://www.exabyte.com/downloads). The firmware file for the autoloader uses the extension `.bin`. The firmware file for the Ethernet module uses the extension `.hex`.

---

**! Important** Make sure that you select and download the correct firmware files. Firmware for other Exabyte products is also on this web site and is not compatible with the Magnum 1x7 LTO Autoloader.

---

2. Connect to the autoloader's FTP interface by following the instructions in the previous section.
3. Make sure that the FTP file transfer type is set to binary.
4. Use the `ls` command to list the files on the autoloader. The autoloader's firmware file is `libflash.bin`. The Ethernet module's firmware file is `enet.hex`.

**Note:** If desired, you can make a copy of the current firmware file(s) by using a "get FTP" command.

5. If necessary, rename the firmware file(s) you downloaded from [www.exabyte.com/downloads](http://www.exabyte.com/downloads) as follows:
  - ▶ Autoloader firmware: Change `filename.bin` to `libflash.bin`
  - ▶ Ethernet module firmware: Change `filename.hex` to `enet.hex`. Use the FTP command for your utility to transfer the new firmware to the autoloader. For example, issue a "put `libflash.bin`" command.

The system initiates the firmware upgrade and displays its progress on the autoloader's LCD. When the upgrade has completed successfully, the autoloader automatically resets.



### Caution

Do not attempt to perform autoloader operations or power down the autoloader until after it automatically resets.

---

## CREATING A DIAGNOSTIC LISTING VIA FTP

To create a diagnostic listing via FTP:

1. Connect to the autoloader's FTP interface by following the instructions on [page 100](#).
2. Make sure that the FTP file transfer type is set to binary.
3. Use the FTP command for your utility to get the diagnostic listing. For example, issue a "get libdump.bin" command.
4. If necessary, specify a destination location (path and filename) for the diagnostic listing.

## LIBTOOL—AUTOLOADER FIRMWARE UPGRADE AND DIAGNOSTICS

You can also use the Exabyte LibTool to upgrade firmware and create diagnostic listings over the SCSI interface. Both LibTool and firmware files are available at [www.exabyte.com/downloads](http://www.exabyte.com/downloads). Refer to the readme file provided with the program for installation instructions. Refer to the program's online help for instructions on performing upgrades and diagnostics.

## LTOTOOL—TAPE DRIVE FIRMWARE UPGRADE AND DIAGNOSTICS

To upgrade firmware and create diagnostic listings for the LTO tape drive, download LTOTool from [www.exabyte.com/downloads](http://www.exabyte.com/downloads). LTOTool allows you to upgrade firmware and perform diagnostics over the autoloader's SCSI bus. Refer to the readme file provided with the program for installation instructions. Refer to the program's online help for instructions on performing upgrades and diagnostics.

**Caution**

Do not upgrade firmware unless Exabyte Technical Support has advised you to do so. If performed improperly, the upgrade procedure can render your tape drive inoperable. Consult with Exabyte Technical Support before performing an upgrade.

---

---

# TROUBLESHOOTING

This chapter provides basic troubleshooting information and provides suggestions for solving problems that may occur when you are installing and operating the autoloader. The Support section of the Exabyte web site, [www.exabyte.com/troubleshoot](http://www.exabyte.com/troubleshoot), also provides helpful troubleshooting tips.

## AUTOLOADER TROUBLESHOOTING

### AUTOLOADER INSTALLATION

If the autoloader and backup software are not communicating after installation, check the following:

- ✓ **Power.** Is the autoloader's power cord inserted correctly, and is the power switch on?
- ✓ **SCSI IDs.** Make sure that the SCSI IDs you selected for the autoloader and tape drive are not the same as the IDs used by any other devices on the SCSI bus, including the SCSI adapter card. See [page 29](#) for information about setting the SCSI IDs.
- ✓ **SCSI connections.** Make sure that you have securely connected the SCSI cable (or cables) and the terminator to the SCSI connectors on the back of the autoloader (see [page 16](#)). Make sure that the SCSI connections to the host computer and other devices on the bus are also secure.
- ✓ **Host adapter card installation.** Make sure that you installed your host adapter card correctly. Refer to the documentation that came with your card for installation and troubleshooting instructions. Pay special attention to steps for setting various jumpers and switches on the card. Make sure that the card is properly seated.
- ✓ **SCSI Controller Type.** Make sure that the SCSI controller is an LVD, non-RAID controller. Exabyte does not support the use of autoloaders or tape devices on RAID controllers.

- ✓ **LVD SCSI devices.** Because the autoloader is an LVD (low-voltage differential) device, all other devices on the SCSI bus should also be LVD. These devices include the controller cards, terminators, and any other devices on the bus. Do not mix LVD and HVD devices on the same bus.

**Note:** Although Ultra-2 and Ultra-3 LVD SCSI are compatible with single-ended SCSI, Exabyte does not support the use of an LVD autoloader on a single-ended SCSI bus.

- ✓ **SCSI cable lengths.** Make sure that the cabling for the SCSI bus attached to the autoloader does not exceed the maximum length restriction (see [page 16](#)).
- ✓ **Termination.** Make sure that the SCSI bus is properly terminated (see [page 15](#)). If another device previously terminated the SCSI bus and is no longer at the physical end of the bus, be sure to remove the terminator from that device.

---

**!** **Important** Both LTO-2 and LTO-3 SCSI tape drives require an Ultra 3 or LVD 160 terminator to function properly on the SCSI bus. An inadequate terminator will result in various SCSI bus issues, including bus hangs and Read/Write failures.

---

- ✓ **Compatibility.** Make sure that your autoloader and tape drive are compatible with the backup software you plan to use. Check [www.exabyte.com/support/online/documentation/compatibility.cfm](http://www.exabyte.com/support/online/documentation/compatibility.cfm) for compatibility information.
- ✓ **Software installation.** Make sure that your application software is installed correctly. (Refer to your software documentation.) Pay special attention to steps that describe how to configure the software for use with the autoloader and tape drive.
- ✓ **Driver installation.** Refer to the installation instructions for your backup application regarding medium changer and tape drive drivers.
  - ▶ Make sure that the driver for your controller card is installed. Refer to the installation instructions for the controller card.
  - ▶ Make sure that the appropriate drivers for the Magnum 1x7 LTO Autoloader and LTO tape drive are installed.

**Notes:** Driver installation may not be necessary and depends on the backup application that you use in your system. Refer to the installation instructions for your backup application for verification.

LTO drivers for Windows native backup application are available as a free download from [www.exabyte.com/support/online/documentation/compatibility.cfm](http://www.exabyte.com/support/online/documentation/compatibility.cfm).



- ✓ **Control mode.** Make sure that the control mode is set correctly.
  - ▶ Use Random mode (the default) with an application that controls the autoloader.
  - ▶ Only use Sequential mode if you plan to operate without autoloader software. In Sequential mode, the autoloader automatically processes cartridges in sequential order without direction from an application. See [page 38](#) for more information about Sequential operation.
- ✓ **Hardware operation.** You can verify that the autoloader hardware is operating using the following methods:
  - ▶ Use the autoloader's Diagnostics menu (under Demo Mode) to move cartridges from random cells in and out of the tape drive. See [page 75](#) for instructions.
  - ▶ Use the autoloader's Command menu to import or export cartridges, and to move specific cartridges into and out of the tape drive. See [page 64](#) for instructions.
  - ▶ Use LibTool to display the current inventory of cartridges, and to move cartridges into and out of the tape drive. Refer to the program's online help for instructions on performing upgrades and diagnostics.

LibTool is available as a free download from [www.exabyte.com/downloads](http://www.exabyte.com/downloads).

If the autoloader reports an error during any of these tests, use LibTool to obtain a diagnostic log from the autoloader immediately after the error is reported (see [page 102](#)). Alternatively, if your autoloader is equipped with the optional Ethernet port, you can use FTP to obtain a diagnostic log from the autoloader (see [page 100](#)). Exabyte Technical Support can examine the log to determine the nature of the reported error.

---

**! Important** After checking the items above, reset the autoloader as described on [page 74](#).

---

## AUTOLOADER OPERATION

If the autoloader has been successfully operating in the past, but is now experiencing problems, check the following:

- ✓ **Control mode.** If you are using application software to control the autoloader, you must set the control mode to Random. Use Sequential mode only if you are operating without autoloader software. See [page 38](#).
- ✓ **Autoloader functions.** You can use the selections in the Diagnostics menu to check specific autoloader functions. See [page 77](#) for instructions.

- ✓ **Hardware operation.** You can verify that the autoloader hardware is operating using the following methods:
  - ▶ Use the autoloader's Diagnostics menu (under Demo Mode) to move cartridges from random cells in and out of the tape drive. See [page 75](#) for instructions.
  - ▶ Use the autoloader's Command menu to import or export cartridges, and to move specific cartridges into and out of the tape drive. See [page 64](#) for instructions.
  - ▶ Use LibTool to display the current inventory of cartridges, and to move cartridges into and out of the tape drive. Refer to the program's online help for instructions on performing upgrades and diagnostics

LibTool is available as a free download from [www.exabyte.com/downloads](http://www.exabyte.com/downloads).

If the autoloader reports an error during any of these tests, use LibTool to obtain a diagnostic log from the autoloader immediately after the error is reported (see [page 102](#)). Alternatively, if your autoloader is equipped with the optional Ethernet port, you can use FTP to obtain a diagnostic log from the autoloader (see [page 100](#)). Exabyte Technical Support can examine the log to determine the nature of the reported error.

- ✓ **Hardware servo error.** If your autoloader is reporting a hardware servo error, check the following:
  - ▶ Make sure that the autoloader is either installed in a rack or is resting on a hard, flat surface.
  - ▶ Make sure that there is nothing resting or pressing on the top of the autoloader.
  - ▶ Make sure that the autoloader is not oriented on its side.
  - ▶ Make sure that the autoloader has the latest version of firmware installed. Firmware upgrade instructions begin on [page 100](#).
  - ▶ Make sure that the cartridge carousel can turn smoothly, as follows:
    1. Power off the autoloader and manually open the door (see [page 67](#) for instructions).
    2. Insert your hand through the door and gently turn the carousel in either direction to turn it.
    3. If the carousel does not turn, remove the tape drive from the autoloader (see [page 93](#)) to determine if there is a cartridge extending from the tape drive and blocking the rotation of the carousel. Remove the cartridge and reinstall the tape drive.

If you are unable to resolve the problem, use LibTool to obtain a diagnostic log from the autoloader immediately after the error is reported (see [page 102](#)). Alternatively, if your autoloader is equipped with the optional Ethernet port, you can use FTP to obtain a diagnostic log from the autoloader (see [page 100](#)). Exabyte Technical Support can examine the log to determine the nature of the reported error.

- ✓ **Firmware level.** Make sure that your autoloader and tape drive contain the latest versions of firmware.
  - ▶ To check the autoloader's code level, see [page 79](#).
  - ▶ To check the tape drive's code level, see [page 85](#).
  - ▶ To determine whether you have the latest version of firmware, check the Exabyte web site at [www.exabyte.com/downloads](http://www.exabyte.com/downloads).

## TAPE DRIVE TROUBLESHOOTING

### TAPE DRIVE OPERATION

Refer to the tape drive product manual for detailed tape drive troubleshooting information. If you have been successfully operating the application software and autoloader in the past, but are now experiencing problems reading and writing data, check the following:

- ✓ **Write-protect switch.** If you are writing data, make sure that the cartridge is write-enabled (see [page 63](#)).
- ✓ **Cartridge type.** Use the appropriate cartridges for your tape drive. See [page 63](#) for information about selecting cartridges.
- ✓ **Cartridge age.** If the cartridge has been in use for a long time or if it has been used frequently, try using a new cartridge.
- ✓ **Cleaning.** Clean the tape drive as described on [page 70](#).

### TAPE DRIVE FAILS WITH SPORADIC ERRORS.

- ✓ **Terminator.** Check the terminator used on the tape drive.

---

**! Important** Both LTO-2 and LTO-3 tape drives require an Ultra 3 or LVD 160 terminator to function properly on the SCSI bus. An inadequate terminator will result in various, sporadic SCSI bus issues, including bus hangs and Read/Write failures.

---

Both LTO-2 and LTO-3 tape drives are Ultra 160 SCSI devices and require a minimum Ultra 160 non-RAID SCSI card, Ultra 160 rated cabling, and an Ultra 160 Active terminator. Cabling and termination rated higher (Ultra 320, for example) is also acceptable.

If you install either an LTO-2 or LTO-3 tape drive in the autoloader, you must connect the correct terminator to avoid the above issues. The terminator must be a high-quality active LVD terminator that complies with the SCSI-3 specification. An appropriate terminator will be stamped with Ultra 3 or LVD 160, as well as “Active Negation.”

Failure symptoms include:

- ▶ Read/Write failure
- ▶ Bus hangs
- ▶ Connectivity issues—tape drive not seen on bus or drops off bus
- ▶ Command failures—commands to this device may fail while commands to other devices on the bus may work properly

## BACKUP SOFTWARE REPORTS AN ERROR

Your backup software may report an error as a result of a failure to communicate with the tape drive or autoloader, a failure by the tape drive to write or read data, or because of a software configuration issue.

### FAILURE TO COMMUNICATE WITH THE TAPE DRIVE

Communication problems on the SCSI bus may be reported by the backup application as resets, a loss of communication with the tape drive or autoloader, failure to detect the tape drive, I/O device errors, or parity errors. These types of errors may occur intermittently.

- ▶ If you have a SCSI autoloader, check the autoloader’s installation on the SCSI bus, described in [“Connecting the Autoloader to SCSI” on page 15](#).

If you have an Ethernet connection to your autoloader, check the autoloader’s Ethernet connection, described in [“Connecting the Autoloader to Ethernet” on page 18](#).

- ▶ Use LibTool and LTOTool to capture the diagnostic logs from the autoloader and the tape drive immediately after an error is reported by your backup software. See [“Advanced Troubleshooting” on page 112](#) for information. Technical Support can examine the log to determine the nature of the reported error.

### FAILURE BY THE TAPE DRIVE TO WRITE OR READ DATA

If your backup software reports a media error, one of the following situations may have occurred:

- ▶ The tape drive needs cleaning (see [“Cleaning the Tape Drive” on page 70](#)). Always try cleaning the tape drive before you assume the cartridge is bad. Be sure to use an LTO Cleaning Cartridge.

- ▶ The cartridge needs to be replaced. Try using a different cartridge for the backup, making sure that the tape is not written in an unsupported format. Mark any cartridge that fails. If you notice that the same cartridge results in multiple failures, replace the cartridge.
- ▶ The backup software has attempted to append data to a cartridge that previously failed. If a write media error previously occurred on the tape, the tape drive cannot append data at the point where the write media error occurred. You can attempt to overwrite the tape, but any attempt to append data will fail.
- ▶ If you are trying to write data, the cartridge may be write-protected. Check the switch on the edge of the cartridge (see [Figure 5-3 on page 63](#)).

If the switch...	the tape is...
does not cover the opening	write-protected
covers the opening	write-enabled

Use a pen or small screwdriver to move the switch.

- ▶ If you used an application other than your normal backup software to write data to the tape, your backup software may report that it does not recognize the tape. For example, if you have used LTO Tool to write and read test data, the test tape will not be “recognized” by your backup software. Perform a tape erase using either LTOTool or your backup software.

## BACKUP SOFTWARE CONFIGURATION ISSUES

If you suspect an issue with the backup software configuration, use LibTool and LTOTool to first confirm that the autoloader and tape drive are working properly. Download and install LibTool and LTO tool from [www.exabyte.com/downloads](http://www.exabyte.com/downloads).

Use **LibTool** to:

- ▶ Detect the autoloader
- ▶ View the autoloader’s cartridge inventory
- ▶ Move tapes into and out of the tape drive

Use **LTOTool** to:

- ▶ Detect the tape drive
- ▶ Perform a Read/Write test

The readme file that accompanies the program (or the online help for the Windows version) provides instructions for using LibTool and LTOTool.

For any questions regarding software configuration, contact your software provider.

## BEFORE CONTACTING TECHNICAL SUPPORT

Before contacting Exabyte Technical Support, complete the following steps to gather all of the required information. Having this information available before you call Technical Support will allow your representative to help you as efficiently as possible. When you have all of the required information, see [“Contacting Exabyte” on page iii](#) to contact Technical Support.

### AUTOLOADER AND TAPE DRIVE INFORMATION

- ▶ **Autoloader serial number and firmware level.** What is the autoloader’s serial number? What version of firmware is currently loaded in the autoloader?
  - ▶ Check [www.exabyte.com/downloads](http://www.exabyte.com/downloads) for the latest release of Magnum 1x7 LTO Autoloader firmware.
  - ▶ Use the operator panel to display information about the autoloader (see [“Viewing Basic Autoloader Information” on page 79](#)).
  - ▶ If your autoloader is not at the latest firmware level, use LibTool to update the firmware (see [“LibTool—Autoloader Firmware Upgrade and Diagnostics” on page 102](#)).
- ▶ **Tape drive serial number and firmware level.** What is the tape drive’s serial number? What version of firmware is currently loaded in the tape drive?
  - ▶ Check [www.exabyte.com/downloads](http://www.exabyte.com/downloads) for the latest release of LTO tape drive firmware.
  - ▶ Use the operator panel to display information about the tape drive (see [“Viewing Basic Tape Drive Information” on page 85](#)).
  - ▶ If your LTO tape drive is not at the latest firmware level, use LTOTool to update the firmware (see [“LTOTool—Tape Drive Firmware Upgrade and Diagnostics” on page 102](#)).

### SCSI BUS INFORMATION

- ▶ **SCSI host bus adapter make and model.** What is the make and model of SCSI host bus adapter connected to the autoloader? Make certain that the SCSI adapter is LVD and that any necessary drivers for the controller are installed.
  - Note:** Exabyte does not support using the autoloader on a RAID controller or on a single-ended controller.
- ▶ **SCSI bus configuration.** What is the configuration of the SCSI bus used by the autoloader?
  - ▶ Are other SCSI devices attached to the SCSI bus?

- ▶ What are the SCSI IDs of all devices attached to the same bus (both internal and external devices)?
- ▶ Is the SCSI bus terminated at the physical end of the bus?
- ▶ What is the total SCSI cable length for all devices (both internal and external devices) on the SCSI bus? See [page 16](#) for information about determining the total SCSI bus length.
- ▶ Check all SCSI cable connectors for bent pins and confirm that all connectors are firmly seated.

## OPERATING SYSTEM INFORMATION

- ▶ **Operating system.** What operating system are you using? Are all current patches installed?
- ▶ **Device drivers.** Are the appropriate drivers installed for the SCSI host bus adapter? Refer to the installation instructions for your SCSI host bus adapter card.

## BACKUP APPLICATION INFORMATION

- ▶ **Backup application name and version.** What backup application are you using?
- ▶ **Compatibility.** Does your application support the Magnum 1x7 LTO Autoloader? Refer to the supported hardware devices list from the application provider. See “[Changing the Emulation Mode](#)” on [page 31](#) for information.
- ▶ **Device drivers.** Are the appropriate drivers installed for the tape drive and for the autoloader?

**Note:** Driver installation may not be necessary and depends on the backup application that you use in your system. Refer to the installation instructions for your backup application for verification.

Driver installation information is available at:  
[www.exabyte.com/support/online/kb/index.cfm](http://www.exabyte.com/support/online/kb/index.cfm).

- ▶ **Backup application log files.** Have the log files from your backup application ready to send to Technical Support.

## DIAGNOSTIC INFORMATION

- ▶ **Autoloader test results.** Use LibTool to test moving tapes in and out of the tape drive, then capture a diagnostic log of the autoloader. Have the log file ready to send to technical support.

- ▶ **Tape drive test results.** Use LTOTool and run a Write/Read test of the tape drive and then capture the diagnostic log from the tape drive and save it to a file.
  - ▶ If the LTOTool Write/Read test reports an error, clean the tape drive and run the test again on a new tape.
  - ▶ Have the diagnostic log file ready to send to Technical Support. Refer to the readme file or on-line help available with the LTOTool for detailed instructions.
- ▶ **Diagnostic log taken after an error.** Capture diagnostic logs from both the tape drive and from the autoloader immediately after your backup application reports an error.
  - ▶ Use LTOTool to capture the diagnostic log from the tape drive.
  - ▶ Use LibTool to capture a diagnostic log from the autoloader.
  - ▶ Alternatively, if your autoloader includes the Remote Management option, you can use it to capture the diagnostic log from the autoloader.

## ADVANCED TROUBLESHOOTING

If you report a problem to Exabyte Technical Support, you may be asked to create a diagnostic listing. Use one of the following options for creating a diagnostic listing.

To create diagnostic listings for:

- ▶ The autoloader—use Exabyte LibTool.
  - ▶ LibTool is available as a free download at [www.exabyte.com/downloads](http://www.exabyte.com/downloads).
  - ▶ See “[LibTool—Autoloader Firmware Upgrade and Diagnostics](#)” on [page 102](#) for instructions.
- ▶ The tape drive—use Exabyte LTOTool
  - ▶ LTOTool is available as a free download at [www.exabyte.com/downloads](http://www.exabyte.com/downloads).
  - ▶ See “[LTOTool—Tape Drive Firmware Upgrade and Diagnostics](#)” on [page 102](#) for instructions.
- ▶ The autoloader using Ethernet—use the autoloader’s Remote Management utility
  - ▶ See “[FTP—Autoloader Firmware Upgrade and Diagnostics](#)” on [page 100](#) for instructions.

To report a problem to Exabyte Technical Support, see [page iii](#).



# SHIPPING THE AUTOLOADER

This chapter describes the process of returning the autoloader for service.

If you need to return the autoloader for service, first contact your service provider. If your service provider instructs you to return the autoloader directly to Exabyte, contact Exabyte Technical Support (see [page iii](#)) to obtain a Return Materials Authorization (RMA) number and the shipping address. When you have the RMA number, follow these instructions.

## PREPARING THE AUTOLOADER FOR SHIPPING

To prepare the autoloader for shipping:

1. Remove all of the cartridges from the autoloader. (See [page 66](#) for instructions.) Make sure that the tape drive does not contain a cartridge.
2. Power off the autoloader.
3. Remove the following from the autoloader:
  - ▶ Power cord
  - ▶ Ethernet cable
  - ▶ SCSI cables
  - ▶ SCSI terminator

## REMOVING THE AUTOLOADER FROM THE RACK

If the autoloader is installed in a rack, remove it as described below.

---

**!** **Important** Do not ship the rack-mounting hardware if you are returning the autoloader for service.

---

1. From the back of the rack, use a #1 Phillips screwdriver to remove the two screws that secure the autoloader to the rails (see [Figure 9-1](#)). Save the screws.

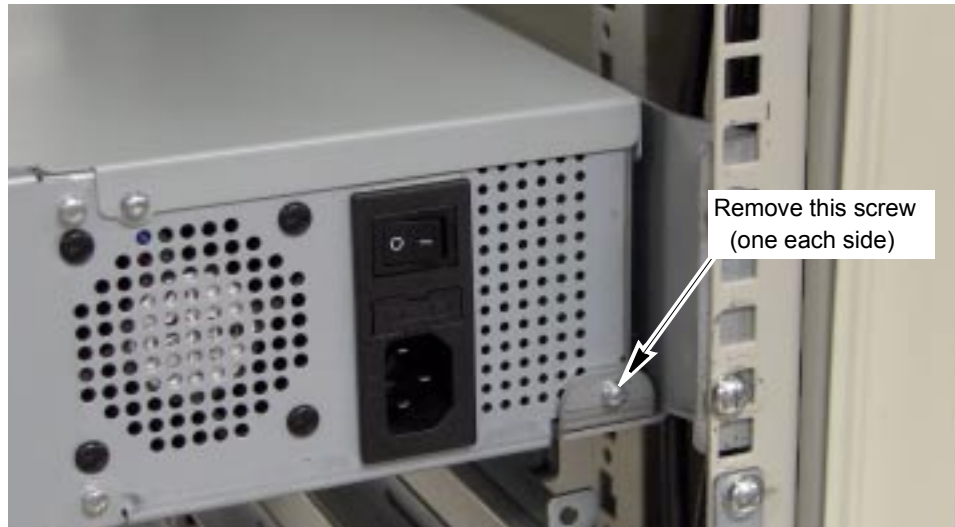

**Figure 9-1** Removing the screws securing the autoloader to the rails

2. From the front of the rack, slide the autoloader forward and out of the rack (see [Figure 9-2](#)).



**Figure 9-2** Removing the autoloader from the rack

## REPLACING THE SHIPPING KEY

Before packing the autoloader, slide the small metal shipping key into the slot in the top of the autoloader. This locks the cartridge loader in place and prevents it from moving during shipping (see [Figure 9-3](#)). Secure the shipping key with tape.

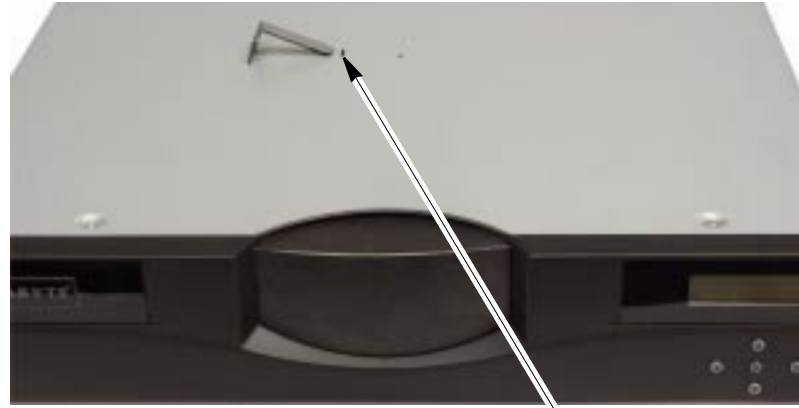

Insert shipping key here

**Figure 9-3** *Placing the shipping key*

## PACKING THE AUTOLOADER

Use the original packing materials (shipping box, foam cushions, foam spacers, and antistatic bag) to pack the autoloader. You will also need packing tape.



### Caution

To avoid damaging the autoloader and voiding your warranty, be sure to use the original shipping materials (or replacement materials obtained from your vendor) when repacking and shipping the autoloader. Do not use the shipping box and packing materials to ship items other than the autoloader and its accessories.

To pack the autoloader:

1. Place the autoloader inside its antistatic bag (see [Figure 9-4](#)). Tape the bag closed.



**Figure 9-4** *Autoloader in antistatic bag*

- Put the foam cushions on the sides of the autoloader, as shown in [Figure 9-5](#) and [Figure 9-6](#).



**Figure 9-5** Installing the first foam packing piece



**Figure 9-6** Foam packing pieces on both sides of autoloader

- If you are shipping the accessory kit with the autoloader, set the accessory kit box into the center of the shipping carton, as shown in [Figure 9-7](#).

---

**! Important** Do not ship accessories such as the power cord, Ethernet cable, SCSI cables, and terminator if you are returning the autoloader for service. Include these items only if you are sending the autoloader to a new location.

---



**Figure 9-7** Accessory kit in shipping box

4. Set the autoloader into the shipping box so that it straddles the accessory box, as shown in [Figure 9-8](#). Place the foam spacers on each end of the autoloader, as shown.

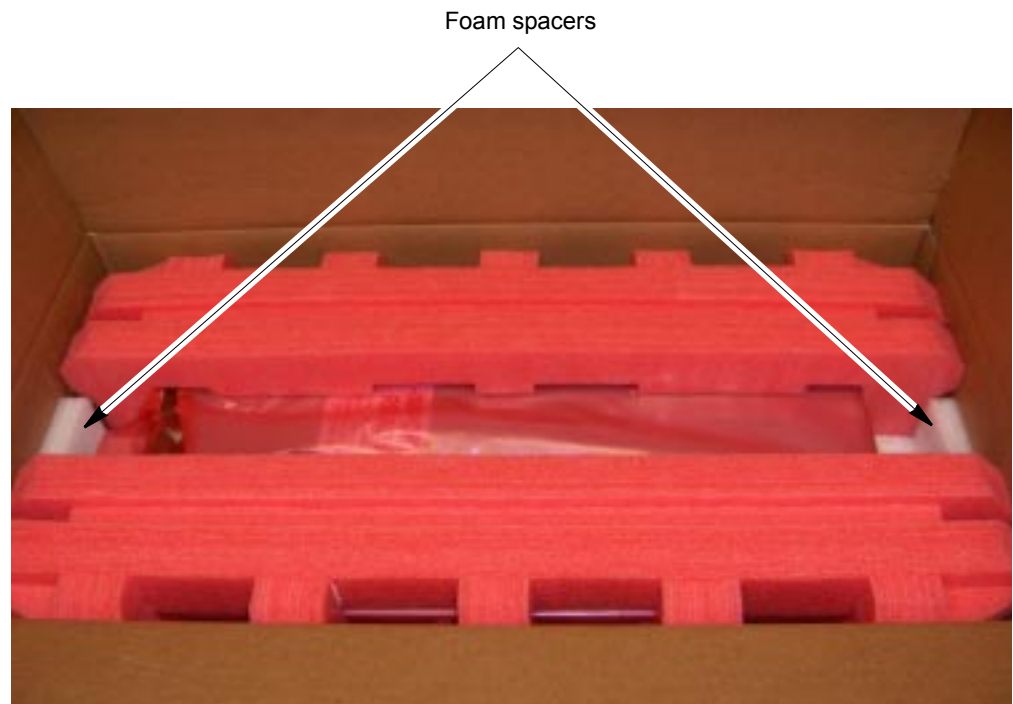

**Figure 9-8** Autoloader in shipping box with end spacers

- Place the foam pads over the foam cushions, as shown in [Figure 9-9](#).



**Figure 9-9** Autoloader in shipping box with top foam pads

- If you are shipping the rail kit with the autoloader, set the rail kit box into the center of the shipping carton on top of the foam pads, as shown in [Figure 9-7](#).

---

**! Important** Do not ship the rail kit if you are returning the autoloader for service. Pack the rail kit with the autoloader only if you are sending the autoloader to a new location.

---



**Figure 9-10** Accessory kit in shipping box (do not ship accessory kit if returning autoloader for service)

- Place any necessary paperwork on top of the autoloader.
- Close and seal the box.
- Place the shipping label on the box.

# A

## SPECIFICATIONS

This appendix provides the following information about the autoloader:

- ▶ Storage capacity
- ▶ Size and weight
- ▶ Performance specifications
- ▶ Power specifications
- ▶ Environmental specifications
- ▶ Safety and regulatory agency compliance

### STORAGE CAPACITY

The maximum storage capacity of the autoloader depends on the type and number of cartridges installed, as shown in [Table A-1](#).

**Table A-1** Maximum autoloader storage capacity

Data Cartridge Type	Maximum Capacity per Cartridge <sup>a</sup>	Maximum Autoloader Capacity (7 Data Cartridges <sup>a</sup> )
LTO-1	200 GB	1.4 TB
LTO-2	400 GB	2.8 TB
LTO-3	800 GB	5.6 TB

<sup>a</sup> Assuming a 2:1 compression ratio. Actual compressed capacity varies depending on the type of data being recorded and the system configuration

### SIZE AND WEIGHT

[Table A-2](#) lists the autoloader's dimensions and weight.

**Table A-2** Autoloader dimensions and weight

<b>Dimensions<sup>a</sup> (L x W x D)</b>	71.12 cm x 44.6 cm x 8.8 cm (28.0 x 17.6 x 3.5 inches)
<b>Weight</b>	20.1 kg (44.4 lb) with no cartridges installed 21.6 kg (47.6 lb) with 7 cartridges installed

<sup>a</sup> Dimension from front rail mount to rear of chassis. Front bezel extends forward and additional 2.0 to 2.5 cm (0.8 to 1.0 inch).

## PERFORMANCE SPECIFICATIONS

This section describes the performance specifications for the autoloader.

### DATA TRANSFER RATE

The data transfer rate for the autoloader depends on the model of tape drive installed, as shown in [Table A-3](#).

**Table A-3** LTO Ultrium tape drive transfer rate and capacity

Tape Drive	Maximum Data Transfer Rate
LTO Ultrium 2	26.6 MB per second (native), 187.2 GB per hour (compressed <sup>a</sup> )
LTO Ultrium 3 <sup>b</sup>	80 MB per second (native), 576 GB per hour (compressed <sup>a</sup> )
LTO Ultrium 3 <sup>c</sup>	60 MB per second (native), 432 GB per hour (compressed <sup>a</sup> )

<sup>a</sup> Assuming a 2:1 compression ratio. Actual compressed transfer rate varies depending on the type of data being recorded and the system configuration.

<sup>b</sup> When attached to an Ultra160 SCSI bus. All sustained data rates are dependent on the capabilities of the SCSI bus (for example, an Ultra2 SCSI bus is limited to less than 40 MB/second). This data is for the IBM full height LTO Ultrium 3 tape drive. For additional information, see [www.storage.ibm.com/tape/lto/oem/index.html](http://www.storage.ibm.com/tape/lto/oem/index.html).

<sup>c</sup> This data is for the Hewlett Packard half height LTO Ultrium 3 tape drive. For additional information, see [www1.hp.com/storage/tapestorage.html](http://www1.hp.com/storage/tapestorage.html).

### TAPE DRIVE PERFORMANCE

When installed in the autoloader, the tape drive performs within its specifications. For more information about tape drive performance specifications, refer to the LTO Ultrium documentation available from:

- ▶ Hewlett-Packard—[www1.hp.com/storage/tapestorage/ultriumdrives.html](http://www1.hp.com/storage/tapestorage/ultriumdrives.html)
- ▶ IBM—[www.storage.ibm.com/tape/lto/oem/index.html](http://www.storage.ibm.com/tape/lto/oem/index.html)

### AUTOLOADER POWER-ON SEQUENCE TIME

Each time the autoloader is powered on, it performs a sequence of activities. During its power-on sequence, the autoloader:

- ▶ Performs a power-on self-test (POST)
- ▶ Runs self-diagnostics
- ▶ Establishes communication with the tape drive
- ▶ Verifies the SCSI IDs
- ▶ Performs a cartridge inventory

The time required for the power-on sequence is measured from the time power is applied until the autoloader indicates ready status.



The autoloader's power-on sequence time is approximately:

- ▶ 60 seconds when the autoloader contains seven cartridges with bar code labels.
- ▶ 160 seconds when the autoloader contains seven cartridges without bar code labels.

## CARTRIDGE INVENTORY TIMES

An application can issue a command to the autoloader to check all cells for cartridges and scan bar code labels. After checking the cells, the autoloader updates its cartridge inventory.

The average cartridge inventory time for 7 cartridges is approximately:

- ▶ 35 seconds when the autoloader contains seven cartridges with bar code labels.
- ▶ 130 seconds when the autoloader contains seven cartridges without bar code labels.

Whenever a cartridge is inserted or removed through the cartridge access port, the autoloader performs a cartridge inventory on the affected cell.

The average time for an individual cartridge cell inventory is:

- ▶ 5 seconds when the cartridge has a bar code label.
- ▶ 20 seconds when the cartridge does not have a bar code label.

## MOVE COMPLETE TIME

Move complete time is the time it takes the autoloader to remove a cartridge from the tape drive, return it to its cell, position a different cell in front of the tape drive, and load the new cartridge into the tape drive.

Move complete time is measured from the time the autoloader receives the move command to the time the autoloader returns status to the initiator indicating that the move is complete. The average move complete time is approximately 26 seconds.

## RELIABILITY

The mean cycles between failures (MCBF) for the autoloader is 250,000 cycles. This value does not include failures attributable to the tape drive or cartridges.

During one full cycle, the autoloader completes the following actions:

- ▶ Picks a cartridge from the tape drive
- ▶ Places the cartridge in its cell
- ▶ Positions a different cell in front of the tape drive
- ▶ Loads the new cartridge into the tape drive

## POWER SPECIFICATIONS

This sections describes the following power specifications for the autoloader:

- ▶ AC input voltages and power consumption
- ▶ Power cord specifications

### AC INPUT VOLTAGES AND POWER CONSUMPTION

The autoloader includes an internal power supply that is capable of accepting 100 to 240 VAC at 50 or 60 Hz. The autoloader has automatic AC input voltage selection. The autoloader is capable of continuous operation when the AC power experiences intermittent operation, voltage surges, and voltage spikes. The maximum operating power consumption for the autoloader is 70 Watts RMS.

### POWER CORD SPECIFICATIONS

The autoloader is shipped with two power cords: One for use in the US and Canada, and one for use in Europe.

The US/Canada power cord is a 2.3-meter (7.5-foot), three-conductor, 18 AWG power cord for 120-volt use. The power cord has a molded NEMA 5-15P male connector on one end and a molded IEC 320/EN60320 female connector on the other end. The power cord is UL Listed and CSA Certified.

The European power cord is a 2.5-meter (8.2-foot) power cord for 230 to 250-volt use. The power cord has a CEE 7 Standard VII, dual earthing male connector on one end, and an IEC 320 C13 female connector on the other end. The cordage is CENELEC HD-21. The power cord is VDE approved.

### Requirements for International 220 VAC Power Cord

If you plan to use the autoloader in a location other than the US/Canada or Europe, you must supply a power cord that meets the following specifications:

- ▶ The power cord must have a grounded attachment plug of the proper type, rating, and safety approval for the intended country.
- ▶ The power cord must have an IEC 320/EN60320 female connector on one end.
- ▶ The cordage must be harmonized to CENELEC publication HD-21. The electrical characteristics and rating must be minimum H05VVF3G1.00 (10 A).

## ENVIRONMENTAL SPECIFICATIONS

This section describes the following environmental specifications for the autoloader:

- ▶ General environmental specifications
- ▶ Particulate contamination limits
- ▶ Acoustic noise limits
- ▶ Shock and vibration limits

### GENERAL ENVIRONMENTAL SPECIFICATIONS

Table A-4 lists general environmental specifications for the autoloader.

**Table A-4** Environmental specifications

Specification	Operating <sup>a</sup>	Storage <sup>b</sup> or Non-Operating <sup>c</sup>	Transportation <sup>d</sup>
<b>Ambient Temperature Range</b>	+10° C to +40° C <sup>e</sup> (+50° F to +104° F)	–40° C to +65° C (–40° F to +150° F)	–40° C to +65° C (–40° F to +150° F)
<b>Temperature Variation<sup>f</sup> (Thermal Gradient)</b>	1° C per minute; max 10° C per hour  (2° F per minute; max 18° F per hour)	1° C per minute; max 20° C per hour  (2° F per minute; max 36° F per hour)	1° C per minute; max 20° C per hour  (2° F per minute; max 36° F per hour)
<b>Relative Humidity</b>	20% to 80% Non-condensing	10% to 90% Non-condensing	10% to 90% Non-condensing
<b>Wet Bulb</b>	26° C (79° F) max	29° C (84° F) max	29° C (84° F) max
<b>Altitude</b>	–304.8 m to +3,048 m (–1,000 ft to +10,000 ft)	–304.8 m to +3,048 m (–1,000 ft to +10,000 ft)	–304.8 m to +12,192 m (–1,000 ft to +40,000 ft)

<sup>a</sup> These measurements assume that the autoloader is installed in accordance with the instructions in this manual.

<sup>b</sup> The autoloader is in its original packaging. The packaging is designed to protect the autoloader from condensation caused by extreme temperature variations (15° C or more). **When the autoloader is moved from a cold storage environment to a warm operating environment, it must be acclimated in its packaging for at least 12 hours before opening to prevent serious condensation damage from occurring.**

<sup>c</sup> The autoloader has been unpacked.

<sup>d</sup> The autoloader has not been unpacked. The transportation period does not exceed 72 hours.

<sup>e</sup> The upper ambient operating temperature limit of +40° C (+104° F) is specified at +914.4 m (+3,000 feet), derated linearly to +24° C (+75.2° F) at +3,048 m (+10,000 feet).

<sup>f</sup> The data cartridges' temperature and humidity must be allowed to stabilize in the specified ambient environment for 24 hours.

### PARTICULATE CONTAMINATION LIMITS

The ambient operating environment for the autoloader should not exceed the particulate counts specified for the tape drive. For more information, refer to the LTO Ultrium tape drive documentation available from the IBM web site at [www.storage.ibm.com/tape/lto/oem/index.html](http://www.storage.ibm.com/tape/lto/oem/index.html).

## ACOUSTIC NOISE LIMITS

The overall, averaged A-weighted sound pressure level (in decibels) for the autoloader does not exceed the upper limits specified in [Table A-5](#).

**Table A-5** Acoustic noise limits

Operating Mode	$L_{pA}$ <sup>a</sup>
The autoloader is powered on and idle.	50 dBA
The carousel or cartridge loader is moving and the tape drive is operating in streaming mode.	60 dBA <sup>b</sup>

<sup>a</sup>  $L_{pA}$  is the average A-weighted sound pressure level over the following frequency range: 5 Hz to 12.5 KHz.

<sup>b</sup> Represents a maximum sustained operational level.

## SHOCK AND VIBRATION LIMITS

The autoloader will operate normally after experiencing shock loads as specified in [Table A-6](#). The operating shock levels indicate how much shock the autoloader can withstand while the enclosed tape drive is reading and writing data. The non-operating and storage shock levels indicate how much shock the autoloader can withstand when it is not operating. After experiencing this amount of shock, the autoloader will operate normally.

**Table A-6** Shock limits

<b>Operating</b>	Random vibration at 1 Hz – 400 Hz @ 0.3 Grms, 20 minutes per axis. Swept Sine 5 Hz – 500 Hz – 5 Hz @ 0.75 g, 1 octave per minute, 3 sweeps per axis 3 g, 5 ms half sine, 20 shocks each side
<b>Non-Operating</b>	Random vibration at 1 Hz – 400 Hz @ 1.06 Grms, 20 minutes per axis. Swept Sine 5 Hz – 500 Hz – 5 Hz @ 0.75 g, 1 octave per minute, 3 sweeps per axis 30 g, 11 ms half sine, 3 shocks per side, 18 total

## SHIPPING SPECIFICATIONS

The autoloader's shipping carton passes the tests described in International Safe Transit Association (ISTA) Procedure 2A.

Table A-7 lists the weight and dimensions of the autoloader packed for shipping. Packaging includes rackmounting kit, power cord, quick start guide, product manual, and product CD.

*Table A-7 Shipping weight and dimensions*

Shipping Weight	Dimensions (Length x Width x Depth)
30.0 kg (66 lb)	88.9 x 57.2 x 22.9 cm (35.0 x 22.5 x 9.0 inches)



### Caution

If you need to re-pack and ship the autoloader, refer to the packing instructions in [Chapter 9](#). To avoid damaging the autoloader, use the original shipping carton and packing materials (or replacement packaging obtained from your vendor). The shipping carton and packing materials are not intended to be used for shipping items other than or in addition to the autoloader and its accessories.

## SAFETY AND REGULATORY AGENCY COMPLIANCE

The Magnum 1x7 LTO Autoloader complies with the safety and regulatory agency standards listed below when installed in accordance with this manual.

### UNDERWRITERS LABORATORY



The Magnum 1x7 LTO Autoloader is listed by Underwriters Laboratories, Inc. Representative samples of this product have been evaluated by UL and meet the applicable U.S. and Canadian safety standards.

### GS



The GS Mark for the Magnum 1x7 LTO Autoloader demonstrates that it has met the requirements of EN60950-1:2001

## UNITED STATES: FCC DECLARATION OF CONFORMITY



We declare under our sole responsibility that:

Product Name: Magnum 1x7 LTO Autoloader

To which this declaration relates, is in conformity with the following standard(s) or other normative documents:

ANSI C63.4-1992 Methods of Measurement

Federal Communications Commission 47 CFR Part 15, Subpart B

15.107 (b) Class A Conducted Limits

15.109 (b) Class A Radiated Emission Limits

This device complies with Part 15 of the FCC Rules. Operation is subject to the following two conditions:

(1) This device may not cause harmful interference, and (2) This device must accept any interference received, including interference that may cause undesired operation.

This equipment has been tested and found to comply with the limits for a Class A digital device, pursuant to Part 15 of the FCC Rules. These limits are designed to provide reasonable protection against harmful interference when the equipment is operated in a commercial environment. This equipment generates, uses, and can radiate radio frequency energy and, if not installed and used in accordance with this manual, may cause harmful interference to radio communications. Operation of this equipment in a residential area is likely to cause harmful interference in which case the user will be required to correct the interference at his own expense.

Shielded cables are required for this device to comply with FCC Rules. Use shielded cables when connecting this device to others.

## CANADIAN VERIFICATION



This Class A digital apparatus complies with ICES-003.

Cet appareil numérique de la classe A est conforme à la norme NMB-003 du Canada.

## EUROPEAN COMMUNITY



This Information Technology Equipment has been tested and found to comply with the following European directives:

(1) EMC Directive 89/336/EEC, amended by directive 93/68/EEC, according to:

EN55022 (Class A)

EN55024

EN 61000-3-2

EN 61000-3-3

(2) Low Voltage Directive 73/23/EEC, amended by directive 93/68/EEC, according to:

EN60950-1:2001

**JAPAN**

この装置は、クラスA情報技術装置です。この装置を家庭環境で使用する  
と電波妨害を引き起こすことがあります。この場合には使用者が適切な対策  
を講ずるよう要求されることがあります。 **VCCI- A**

**Translation:** This is a Class A product based on the standard of the Voluntary Control Council for Interference by Information Technology Equipment (VCCI). If this equipment is used in a domestic environment, radio disturbance may arise. When such trouble occurs, the user may be required to take corrective actions.

**AUSTRALIA AND NEW ZEALAND**

This device has been tested and found to comply with the limits for a Class A digital device, pursuant to the Australian/New Zealand standard AS/NZS 3548 set out by the Australian Communications Agency.

**RESTRICTION OF HAZARDOUS SUBSTANCES IN ELECTRICAL AND ELECTRONIC EQUIPMENT (RoHS)**

The RoHS mark indicates compliance with European Council Directive 2002/95/EC, on the restriction of the use of certain hazardous substances in electrical and electronic equipment.

**WASTE OF ELECTRONIC AND ELECTRICAL EQUIPMENT (WEEE)**

This device is in compliance with 2002\96\EC Waste of Electronic and Electrical Equipment (WEEE).

## NOTES



# B

## WRITE ONCE, READ MANY (WORM) CAPABILITY

### OVERVIEW

Certain records retention and data security applications require a Write Once, Read Many (WORM) method for storing data on tape. To meet this data storage requirement, a new WORM feature is now available on the Magnum 1x7 LTO Autoloader when you have an LTO-3 tape drive installed.

**Note:** Only the LTO-3 tape drive has WORM capability. It is not available on the LTO-2 or LTO-1 tape drives.

No physical hardware changes are required to make the tape drive compatible with the WORM feature; however, appropriate WORM-capable drive firmware must be installed. See [“Requirements” on page 131](#) to determine the firmware requirements.

### WORM MEDIA

Because standard read/write media are incompatible with the WORM feature, a specially formatted WORM tape cartridge (see [Figure B-1](#)) is required. Each WORM cartridge has a unique, worldwide cartridge identifier (WWCID), which comprises the unique CM chip serial number and the unique tape media serial number.

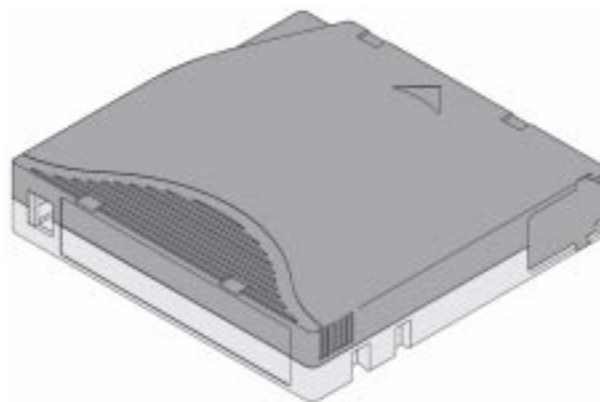

**Figure B-1** Ultrium 3 WORM tape cartridge

Table B-1 lists WORM media specifications.

**Table B-1** WORM tape cartridge specifications

Tape Cartridge	Case Color	Native Data Capacity
Ultrium 3 WORM	Two toned colored cartridge <sup>a</sup>	400 GB (800 GB at 2:1 compression)

<sup>a</sup> The two-toned coloring allows you to easily distinguish WORM cartridges from Write/Read cartridges.

## DATA SECURITY ON WORM MEDIA

Certain built-in security measures help ensure that the data written on a WORM cartridge does not become compromised, for example:

- ▶ The format of an IBM Ultrium 3 400 GB WORM Tape Cartridge is unlike that of standard read/write media. This unique format prevents a drive that lacks WORM-capable firmware from writing on a WORM tape cartridge.
- ▶ When the LTO-3 tape drive senses a WORM cartridge, the firmware prohibits the changing or altering of user data already written on the tape. The firmware keeps track of the last appendable point on the tape.

## WORM MEDIA ERRORS

The following conditions cause WORM media errors to occur:

- ▶ Information in the servo manufacturer's word (SMW) on the tape must match information from the cartridge memory (CM) module in the cartridge.
  - ▶ If it does not match, the tape drive will report a Media Error code.
  - ▶ If your backup application or operating system returns SCSI sense information, the Sense information will be **Sense Key (03) Medium error**.
- ▶ Inserting a WORM tape cartridge into a tape drive that is not compatible with WORM causes the cartridge to be treated as an unsupported medium. The tape drive will report a media Error Code **7**.
  - ▶ Only LTO-3 tape drives have WORM capability. Inserting a WORM cartridge into an LTO-2 or an LTO-1 tape drive will produce the above error.
  - ▶ If you are using an LTO-3 tape drive and receive the above error, upgrading your LTO-3 tape drive's firmware to the correct code level will resolve the problem. The firmware must be at version 54xx or higher and is available as a free download at [www.exabyte.com/downloads](http://www.exabyte.com/downloads).

## REQUIREMENTS

The WORM feature requires the following:

- ▶ LTO-3 generation of tape drive—the WORM feature is not available on earlier generations of LTO tape drives (LTO-2 or LTO-1)
- ▶ WORM-capable drive firmware release 54xx or higher
- ▶ Special WORM tape cartridges

You can use LTOTool to determine the firmware level currently in the tape drive. Refer to the readme file provided with the program for installation instructions. Refer to the program's online help for instructions on determining the tape drive firmware level.

If your tape drive has an earlier version of firmware, you can download the updated firmware by visiting the download page on the Exabyte web site at [www.exabyte.com/downloads](http://www.exabyte.com/downloads).

**Note:** Refer to “FTP—Autoloader Firmware Upgrade and Diagnostics” on page 100 for instructions on upgrading the tape drive firmware.

## TAPEALERT FLAGS

Table B-2 shows the new TapeAlert flags associated with the WORM cartridge. Refer to the *Exabyte Magnum 1x7 LTO Autoloader SCSI Reference* for additional information about TapeAlert.

**Table B-2** TapeAlert flags associated with the WORM media

Parameter Code		Description	Set	Clear	Type
In Hex	In Decimal				
3Bh	59	<b>(WORM Medium – Integrity Check Failed)</b> Set when the drive determines that the data on tape is suspect from a WORM point of view.		L	Critical
3Ch	60	<b>(WORM Medium – Overwrite Attempted)</b> Set when the drive rejects a Write operation because the rules for allowing WORM writes have not been met.	E		Critical

## ERROR CODES

Tape drive errors associated with the new WORM capability result in either a Medium Error (Sense Key 3h) or a Data Protect error (Sense Key 7h). The tape drive returns this error information in response to a SCSI REQUEST SENSE command. Refer to the tape drive SCSI reference for additional information about the error codes returned by the REQUEST SENSE command.

[Table B-3](#) shows the new ASC/ASCQ error codes for Sense Key 3h (Medium Error).

**Table B-3** ASC/ASCQ error codes for a Medium Error (SK 3) with WORM media

ASC	ASCQ	Description
04h	10h	Logical Unit Not Ready, Auxiliary Memory Not Accessible.
11h	12h	Auxiliary Memory Read Error
30h	0Dh	<b>Medium Error/WORM Medium – Integrity Check:</b> Set when the drive rejects a Read operation because the current cartridge is a Suspicious WORM cartridge, and the WTRE bit is set to 0.

[Table B-4](#) shows the new ASC/ASCQ error codes for Sense Key 7h (Data Protect).

**Table B-4** ASC/ASCQ error codes for a Data Protect error (SK 7) with WORM media

ASC	ASCQ	Description
30h	0Dh	<b>Data Protect/WORM Medium – Integrity Check:</b> Set when the drive rejects a Write operation because the current cartridge is a Suspicious WORM cartridge.
30h	0Ch	<b>Data Protect/WORM Medium – Overwrite Attempted:</b> Set when the drive rejects a Write operation because the rules for allowing WORM writes have not been met.

# C

## ERROR MESSAGES

This appendix defines error messages that may appear on the autoloader's operator panel and provides corrective actions.



### Caution

Most autoloader components can be replaced only by Exabyte-approved service providers. If you cannot find an obvious cause for the problem, contact your service provider. Do not attempt to replace any components other than the tape drive. If you do, you will void your warranty.

---

---

### ! Important

Some corrective actions advise you to reset or power the autoloader off and back on. To avoid disrupting communication between the host computer and other devices on the bus, make sure that there is no activity on the bus before you reset or power off the autoloader.

If you need to power the autoloader off, first unload the cartridge from the tape drive, if possible. If you power the autoloader off and back on while a cartridge is in the tape drive, the drive may have to perform a lengthy format recovery process.

---

[Table C-1](#) lists autoloader error messages in alphabetical order. If the suggested corrective action does not correct the error, contact Exabyte Technical Support (see [page iii](#)) or your service provider.

**Table C-1** Autoloader error messages

Error Message	Description	Corrective Action
<b>Bootblock</b>	An error occurred during a firmware upload to the autoloader.	<ol style="list-style-type: none"> <li>1. Verify that you loaded the correct code. Do not load firmware from one model of autoloader or autoloader into another.</li> <li>2. Reset the autoloader (see <a href="#">page 74</a>) and reload the firmware.</li> <li>3. If the error persists, contact Exabyte Technical Support (see <a href="#">page iii</a>) or your service provider.</li> </ol>
<b>Cartridg.Invalid</b>	An attempt was made to load an incompatible cartridge into the tape drive or a spent cleaning cartridge and the cartridge was ejected.	<ul style="list-style-type: none"> <li>▪ Remove the cartridge from the autoloader and replace it with one that is compatible with the tape drive.</li> <li>▪ If you were attempting to import a cleaning cartridge, insert a cartridge with cleaning cycles remaining on it.</li> </ul>
<b>Command Failed Check Ship Lock</b>	The cartridge loader could not move because it may be locked in place by the shipping key.	Remove the shipping key (see <a href="#">page 8</a> ).
<b>Command Failed Drive is Full</b>	A command was issued from the operator panel to load a cartridge into the tape drive when the drive already contained a cartridge.	Wait until the current cartridge is unloaded by the application, or use the operator panel to unload it from the tape drive (see <a href="#">page 69</a> ).
<b>Command Rejected Carousel Full</b>	A command was issued from the operator panel to insert a cartridge into the autoloader when all of the cartridge cells were already full.	Export a cartridge from the autoloader to make room for a new cartridge (see <a href="#">page 66</a> ).
<b>Command Rejected Empty Carousel</b>	A command was issued from the operator panel to either load a cartridge into the tape drive or remove a cartridge from the autoloader when there were no cartridges in the cartridge carousel.	Wait until the cartridge is ejected from the tape drive, or use the operator panel to import cartridges into the autoloader (see <a href="#">page 64</a> ).
<b>Configuration Locked by Host</b>	The application is currently controlling the autoloader (a SCSI command is active) or the Remote Management utility (see <a href="#">Chapter 4</a> ) is controlling the autoloader.	Wait for the command from the application to complete.
<b>Device Not Ready</b>	The autoloader is not ready to perform the requested operation because it is performing diagnostics or its power-on self-test (POST).	Wait until the autoloader has finished, then retry the operation.

**Table C-1** Autoloader error messages (continued)

Error Message	Description	Corrective Action
<b>Drive CMD Error</b>	The tape drive received an invalid command.	<ol style="list-style-type: none"> <li>1. If possible, use the operator panel to unloaded any cartridge that is in the tape drive (see <a href="#">page 69</a>).</li> <li>2. Power the autoloader off and back on to reset the tape drive.</li> <li>3. If the error persists, contact Exabyte Technical Support (see <a href="#">page iii</a>) or your service provider.</li> </ol>
<b>Drive Load Fail</b>	The cartridge couldn't be loaded into the tape drive because of a mechanical problem or because of a broken tape.	<ol style="list-style-type: none"> <li>1. Export the tape from the autoloader (see <a href="#">page 66</a>) and verify that it is in good condition, then retry the operation. Replace the cartridge if necessary.</li> <li>2. If the error persists, contact Exabyte Technical Support (see <a href="#">page iii</a>) or your service provider.</li> </ol>
<b>Drive Timeout</b>	The tape drive took too long to load or unload a tape, or the tape drive is not responding.	<ol style="list-style-type: none"> <li>1. If possible, use the operator panel to unloaded any cartridge that is in the tape drive (see <a href="#">page 69</a>).</li> <li>2. Power the autoloader off and back on to reset the tape drive.</li> <li>3. If the error persists, contact Exabyte Technical Support (see <a href="#">page iii</a>) or your service provider.</li> </ol>
<b>Drv Unload Fail</b>	The cartridge couldn't be unloaded from the tape drive because of a mechanical problem.	<ol style="list-style-type: none"> <li>1. Power the autoloader off and back on to reset the tape drive.</li> <li>2. Retry the unload operation once.</li> <li>3. If the error persists, contact Exabyte Technical Support (see <a href="#">page iii</a>) or your service provider.</li> </ol>
<b>H/W Inoperable</b>	An operation couldn't be completed because of a mechanical problem.	<ol style="list-style-type: none"> <li>1. Reset the autoloader and retry the operation. See <a href="#">page 74</a> for reset instructions.</li> <li>2. If the error persists, contact Exabyte Technical Support (see <a href="#">page iii</a>) or your service provider.</li> </ol>
<b>Hardware Error</b>	An operation couldn't be completed because of a mechanical problem.	<ol style="list-style-type: none"> <li>1. Reset the autoloader and retry the operation. See <a href="#">page 74</a> for reset instructions.</li> <li>2. If the error persists, contact your service provider.</li> </ol>

**Table C-1** Autoloader error messages (continued)

Error Message	Description	Corrective Action
<b>In Enet Mode</b>	The autoloader is executing a command issued from the Remote Management utility (see <a href="#">Chapter 4</a> ) when a command is issued from the operator panel.	Wait until the autoloader has finished its current operation, then retry the operation.
<b>In Security Mode Choice Rejected</b>	Autoloader security has been set from the application.	Disable autoloader security from the application.
<b>Library is BUSY</b>	The autoloader is executing a command issued from the application when a command is issued from the operator panel.	Wait until the autoloader has finished its current operation, then retry the requested operation.
<b>Media Removal is Locked by Host</b>	Media removal from the autoloader has been prevented through the application.	Turn off media removal prevention from the application and retry the operation.
<b>Over Temperature</b>	The tape drive's temperature limit has been exceeded, and the cartridge has been ejected from the drive.	<ul style="list-style-type: none"> <li>▪ Wait until the autoloader has cooled, then unload the cartridge to a cell and re-load it into the tape drive.</li> <li>▪ Check the room temperature. The ambient temperature must be no more than 40°C (104°F).</li> <li>▪ Provide additional air flow around the autoloader to improve cooling.</li> </ul>
<b>POST Failed</b>	The autoloader encountered an error during its power-on self-test.	<ol style="list-style-type: none"> <li>1. Reset the autoloader and retry the operation. See <a href="#">page 74</a> for reset instructions.</li> <li>2. If the error persists, contact Exabyte Technical Support (see <a href="#">page iii</a>) or your service provider.</li> </ol>
<b>Sequential Mode</b>	An application tried to issue commands to the autoloader while it was in Sequential mode.	Set the autoloader to Random mode (see <a href="#">page 38</a> ).
<b>Servo Error</b>	The autoloader carousel has experienced a problem.	<ol style="list-style-type: none"> <li>1. Reset the autoloader and retry the operation. See <a href="#">page 74</a> for reset instructions.</li> <li>2. If the error persists, contact Exabyte Technical Support (see <a href="#">page iii</a>) or your service provider.</li> </ol>
<b>Servo Jammed</b>	The autoloader carousel has experienced a problem.	<ol style="list-style-type: none"> <li>1. Reset the autoloader and retry the operation. See <a href="#">page 74</a> for reset instructions.</li> <li>2. If the error persists, contact Exabyte Technical Support (see <a href="#">page iii</a>) or your service provider.</li> </ol>



**Table C-1** Autoloader error messages (continued)

Error Message	Description	Corrective Action
<b>Servo Timeout</b>	The autoloader carousel has experienced a problem.	<ol style="list-style-type: none"> <li>1. Reset the autoloader and retry the operation. See <a href="#">page 74</a> for reset instructions.</li> <li>2. If the error persists, contact Exabyte Technical Support (see <a href="#">page iii</a>) or your service provider.</li> </ol>
<b>System Error</b>	The autoloader has experienced a fatal error.	<ol style="list-style-type: none"> <li>1. Reset the autoloader and retry the operation. See <a href="#">page 74</a> for reset instructions.</li> <li>2. If the error persists, contact Exabyte Technical Support (see <a href="#">page iii</a>) or your service provider.</li> </ol>
<b>System Timeout</b>	An autoloader operation took too long.	<ol style="list-style-type: none"> <li>1. Reset the autoloader and retry the operation. See <a href="#">page 74</a> for reset instructions.</li> <li>2. If the error persists, contact Exabyte Technical Support (see <a href="#">page iii</a>) or your service provider.</li> </ol>
<b>Tape Alert Halt</b>	The autoloader has experienced a Tape Alert event.	<ol style="list-style-type: none"> <li>1. Reset the autoloader and retry the operation. See <a href="#">page 74</a> for reset instructions.</li> <li>2. If the error persists, contact Exabyte Technical Support (see <a href="#">page iii</a>) or your service provider.</li> </ol>
<b>Tape incorrectly inserted. RETRY</b>	A tape was inserted through the cartridge access port in the wrong orientation.	Position the cartridge with the hub down and the side with the bar code label and write-protect switch towards the door (see <a href="#">page 65</a> ) and re-insert it. Do not insert cartridges with the label and write-protect switch toward you. The arrow on the cartridge must face toward the outside.
<b>Wait for Command To Complete</b>	The autoloader is executing a command issued from the application or the Remote Management utility when a command is issued from the operator panel.	Wait until the autoloader has finished its current operation, then retry the operation.

## NOTES

# INDEX

## #

210 Emulation mode [31](#)

## A

accessories [9 to 10](#)

acoustic noise limits [124](#)

advanced troubleshooting [112](#)

agency compliance [125 to 127](#)

agency declarations

    Australia and New Zealand [127](#)

    Canadian Verification [126](#)

    European Community [126](#)

    FCC notice [126](#)

    GS mark [125](#)

    RoHS [127](#)

    Underwriters Laboratory [125](#)

    VCCI Class A [127](#)

    WEEE [127](#)

altitude limits [123](#)

application

    See software

Autoclean option [34](#)

autoloader configuration

    See configuration

automatic drive cleaning [32 to 35](#)

## B

back panel components [3 to 4](#)

bar code labels

    preparing [10](#)

    re-scanning [87](#)

    viewing contents [51, 86](#)

bar code scanner [2, 5](#)

bus

    See SCSI bus

## C

capacity, autoloader [119](#)

cartridge

    See also WORM media

cartridge access port

    description [3](#)

    operating manually [67 to 68](#)

    using [62 to 68](#)

cartridge carousel [5](#)

cartridge inventory

    after exporting cartridges [67](#)

    after power-on [19](#)

    after reset [74](#)

    time required [121](#)

    updating [87](#)

    viewing on LCD [86 to 88](#)

    viewing through Remote Management utility [51](#)

cartridge loader [5](#)

cartridges

    inserting [64 to 65](#)

    preparing [63](#)

    purchasing [10](#)

    removing (power off) [67](#)

    removing (power on) [66](#)

    selecting [10](#)

    storing [78](#)

    viewing inventory [51, 86 to 88](#)

cleaning

    autoloader [99](#)

    setting up automatic drive cleaning [32 to 35](#)

    tape drive [70 to 73](#)

cleaning cartridge  
 activating cleaning cartridge cell 32  
 enabling Autoclean option 32 to 35  
 inserting when cleaning is required 71 to 73  
 requirements 63  
 storing in autoloader 62, 70 to 72  
 using 70 to 73

code load  
 See firmware

code version  
 autoloader 49, 79  
 tape drive 49, 85

compatible tape cartridges 63

components  
 back panel 3 to 4  
 front panel 2 to 3  
 internal 4 to 5

configuration  
 accessing options 21 to 25  
 automatic drive cleaning 32 to 35  
 changing from operator panel 26 to 44  
 changing through Remote Management utility 55  
 checking setup 45  
 emulation mode 31 to 32, 56  
 Ethernet 35 to 38  
 LCD contrast 28  
 LCD language 27  
 menu overview 24 to 25  
 password 40 to 44  
 restore default configuration 44 to 44  
 restoring default values 44 to 44  
 SCSI IDs 29 to 31  
 sequential mode 38 to 40  
 SNMP 57  
 using operator panel 21 to 23  
 using Remote Management utility 47 to 60

contrast, LCD 28

control modes 38 to 40

## D

data cartridge  
 supported by tape drive 63

data cartridges  
 See cartridges

Data Protect (SK 7h) error, WORM media 132

data transfer rate 120

demos, running 75 to 76

DHCP  
 specifying 35 to 38  
 viewing address 79

diagnostic listings, creating for  
 troubleshooting 100 to 102

diagnostics  
 generating log files 112  
 running from operator panel 77  
 running through Remote Management utility 59

dimensions  
 autoloader 119  
 shipping container 125

drive  
 See tape drive

dump  
 See diagnostic listings

## E

electrostatic discharge (ESD) 11

emulation mode  
 changing from operator panel 31 to 32  
 changing using Remote Management utility 56  
 description 31

environmental specifications 123

error messages on the LCD 133 to 137

errors  
 Data Protect (SK 7h) error with WORM media 132  
 Medium Error (SK 3h) with WORM media 132  
 reported in software 108 to 109

Ethernet  
 cable requirements 9  
 configuring interface 35 to 38  
 connecting autoloader to 18  
 creating diagnostic listings via  
 FTP 100 to 102  
 FTP user name and password 57  
 upgrading firmware via FTP 100 to 101  
 using Remote Management utility 47 to 60

Ethernet configuration  
 changing from operator panel 35 to 38  
 changing through Remote Management utility 56

Ethernet port, connecting to 18

event log, viewing 90

- Exabyte LibTool 102, 112
  - Exabyte LTOTool 102, 112
  - Exabyte, contacting iii
  - EZ17 Autoloader emulation mode 31
- ## F
- fan 4
  - features 1 to 2
  - firmware
    - upgrading for autoloader via
      - FTP 100 to 101
    - upgrading for autoloader via SCSI 102
    - viewing autoloader code level 79
    - viewing tape drive code level 85
    - WORM requirements 131
  - front panel components 2 to 3
  - FTP
    - connecting to interface 100
    - diagnostic logs 112
    - setting user name and password 57
    - using to create diagnostic listings 102
    - using to upgrade firmware 100 to 101
- ## G
- gateway address 35 to 38
- ## H
- history
    - See event log
  - Home screen 22
  - humidity specifications 123
- ## I
- IDs
    - See SCSI IDs
  - inserting cartridges 64 to 65
  - installation
    - accessories and equipment for 9 to 11
    - application software 11
    - connecting the power cord 19
    - connecting to Ethernet 18
    - connecting to SCSI 15 to 18
    - environment 11
    - powering on 19
    - preparing for 10
    - rack-mounting 11 to 15
    - troubleshooting 103 to 105
    - verifying the hardware setup 20
  - installation (directions)
    - connecting to SCSI 15 to 18
  - internal components 4 to 5
  - inventory
    - See viewing cartridge inventory
  - IP address 35 to 38
- ## K
- keypad
    - description 3
    - using 21 to 23
- ## L
- language, LCD 27
  - LCD
    - changing contrast 28
    - changing language 27
    - description 3
    - error messages 133 to 137
    - See also operator panel
  - LED, status 3, 3, 61
  - LibTool
    - advanced troubleshooting 112
    - creating diagnostic logs 102
    - upgrading autoloader firmware 102
  - loader, cartridge 5
  - LTO-3 terminator requirements 16
  - LTOTool
    - advanced troubleshooting 112
    - creating diagnostic logs 102
    - upgrading tape drive firmware 102
  - LVD SCSI 2, 9, 15, 104
- ## M
- maintenance
    - cleaning autoloader 99
    - cleaning tape drive 70 to 73
    - creating diagnostic listings 100 to 102
    - replacing the tape drive 91 to 99
    - upgrading firmware 100 to 102
  - media
    - See WORM media
  - media related errors 130

Medium Error (SK 3h), WORM media 132

menu overview 24 to 25

## N

Native emulation mode 31

noise limits 124

## O

operating environment specifications 123

operation

cleaning the tape drive 70 to 73

inserting cartridges 62 to 65

loading cartridge in tape drive 68

powering on autoloader 19

preparing cartridges 63

Random mode 38

removing cartridges (power off) 67

removing cartridges (power on) 66

resetting autoloader and tape drive 74 to 75

running demos 75 to 76

Sequential mode 38 to 40

unloading cartridge from tape drive 69

using cartridge access port 62 to 68

using operator panel 21 to 23

using Remote Management utility 47 to 60

viewing autoloader and tape drive information 79 to 90

operator panel

Home screen 22

location 3

menu overview 24 to 25

preventing access to menus 40 to 42

using 21 to 23

## P

packing for shipment 115 to 118

particulate limits 123

password

accessing password-protected menus 42

disabling for operator panel 42

setting for FTP 57

setting for operator panel 40 to 42

setting for Remote Management utility 58

performance specifications 120 to 122

power consumption 122

power cord

connecting 19

specifications 122

power switch 4

powering on the autoloader 19

preparing cartridges 63

product warranty caution iii

## R

rack mounting

installation 11 to 15

removing from rack 114

Random mode

*See also* Sequential mode 38

Random operating mode 38

regulatory agency compliance 125 to 127

reliability specification 121

Remote Management option 18

Remote Management utility 2, 47 to 60

accessing 47

setting Ethernet configuration 35

removing cartridges

with power off 67

with power on 66

resetting autoloader and tape drive 74 to 75

returning autoloader for service 113 to 118

RMA number, obtaining 113

## S

safety agency compliance 125 to 127

SCSI (cable)

connecting 15 to 18

SCSI bus

cable requirements 9

connecting autoloader to 15 to 18

length restrictions 16

LVD configuration 15

terminator requirements 9

troubleshooting 110

SCSI cables

connecting 15 to 18

requirements 9

SCSI connectors 4

SCSI host bus adapter card 10

- SCSI IDs
    - changing 29 to 31
    - default for autoloader 30
    - default for tape drive 31
  - SCSI terminator
    - installing 16 to 18
    - requirements 9
  - security
    - accessing password protected menus 42
    - disabling operator panel password 42
    - setting operator panel password 40 to 42
    - setting Remote Management utility password 58
    - setting through application 43
  - sensors, viewing readings 82 to 85
  - Sequential mode 38 to 40
  - serial number
    - autoloader 49, 79
    - tape drive 49, 85
  - service, returning the autoloader iii, 113 to 118
  - shipping key, removing 8
  - shipping specifications 125
  - shipping the autoloader 113 to 118
  - shock limits 124
  - single-character display
    - error codes and messages with WORM media 130
  - size
    - autoloader 119
    - shipping container 125
  - SNMP configuration 57
  - software
    - doesn't support autoloader 31
    - installing 11
    - LibTool 102
    - Remote Management utility 47 to 60
    - setting security through application 43
  - specifications
    - agency compliance 125 to 127
    - capacity 119
    - data transfer rate 120
    - environmental 123
    - performance 120 to 122
    - power 122
    - reliability 121
    - shipping 125
    - size 119
    - weight 119
  - statistics
    - autoloader 79 to 82
    - cartridge cell 88 to 89
    - viewing through Remote Management utility 58
  - status LED 3, 3, 61
  - storage capacity, autoloader 119
  - storing cartridges 78
  - subnet mask 35 to 38
  - system sensors 82 to 85
- ## T
- tape drive
    - cleaning 70 to 73
    - code version 85
    - description 1
    - firmware requirements for using WORM 131
    - loading and unloading cartridges 68 to 70
    - location 4
    - replacing 91 to 99
    - resetting 74 to 75
    - serial number 85
    - setting SCSI ID 30
    - viewing information about 85
  - tape drive cover plate
    - location 4
    - removing 93
  - TapeAlert flags 131
  - tapes
    - See cartridges
  - Technical Support iii
    - gather required information before contacting 110 to 112
  - temperature, operating 123
  - termination, SCSI
    - installing terminator 16 to 18
    - LTO-3 requirements 16
    - terminator requirements 9
  - transfer rate 120
  - troubleshooting 103 to 112
- ## V
- viewing cartridge inventory 51, 86 to 88
  - VXA Autopak 1x10 emulation mode 31

**W**

warranty

product warranty caution [iii](#)

weight

autoloader [119](#)

shipping [125](#)

wide SCSI [4, 9, 15](#)

worldwide cartridge identifier (WWCID) [129](#)

Write Once, Read Many (WORM) capability

firmware requirements [131](#)

overview [129, 133](#)

Write Once, Read Many (WORM) media

characteristics [129](#)

data security [130](#)

errors [130](#)

specifications [130](#)



## PRODUCT LIMITED WARRANTY

Exabyte Corporation ("Exabyte") warrants to the original End User ("Purchaser") that this computer product purchased from Exabyte or an authorized Exabyte dealer ("Product") is free from manufacturing defects in material and workmanship for the applicable warranty period set forth below and as stated in the Product Specification, from the date of shipment to Exabyte's authorized dealer. In order to receive warranty services, contact the appropriate Exabyte location shown at the following web address, [www.exabyte.com/contact](http://www.exabyte.com/contact). Do not return Product to place of purchase. Product returns must reference an Exabyte Return Material Authorization Number ("RMA #") and any Product received by Exabyte without an RMA# will be refused and returned to Purchaser. Purchaser will need to provide the following information:

- ▶ Date hardware was purchased
- ▶ Hardware type
- ▶ Serial number of hardware
- ▶ Company name and address; name, email address and telephone number; name of reseller where hardware was purchased
- ▶ Description of the problem with as much detail as possible
- ▶ Computer type, Operating System, Backup Application used
- ▶ Whether Product is used as a single drive or in a library and type of library

Purchaser may be required to perform certain diagnostics tests on Product prior to Exabyte issuing an RMA #. Exabyte, at its discretion, may use new, refurbished, or reconditioned replacements parts to perform any warranty repair or replacement of Products. Exabyte also reserves the option to replace the entire Product with a comparable Product or refund the then-current purchase price of the Product. Exabyte Products or parts that are replaced or repaired under this warranty are warranted for the remaining unexpired portion of the original warranty period. This constitutes Purchaser's sole and exclusive remedy in the event of a defect. Warranty registration must be completed and verified prior to any warranty claims.

This limited warranty covers defects encountered in the normal use of the Product during the warranty period and does not apply under the following conditions: Product is damaged due to physical abuse, mishandling, accident, negligence or failure to follow operating instructions; Product is modified by Purchaser in any manner other than that for which it was intended or otherwise approved by Exabyte, including, but not limited to tempering, ruggedizing, and/or militarizing the Product; damage or defects caused by the use of unauthorized parts or by unauthorized service; the Product has been subject to unsuitable operating or physical conditions outside those recommended in Product specifications as provided by Exabyte; Product has its serial numbers altered or removed; or Product is damaged due to improper packaging of the warranty return to the Exabyte dealer or Exabyte.

With respect to items manufactured or supplied by a third party which are sold by Exabyte, you shall be the beneficiary of the manufacturer's warranty, if any, SUBJECT TO THE LIMITATIONS STATED THEREIN. Copies of such manufacturer's warranties will be made available upon request. EXABYTE DISCLAIMS AND EXCLUDES ALL WARRANTIES WITH RESPECT TO SUCH ITEMS.

In the event software is provided hereunder, Exabyte warrants that, for a period of ninety (90) days from the date of shipment to Exabyte's authorized dealer, the media on which any software is provided are free from defects in material and workmanship under normal use and that the software recorded therein is properly recorded. Exabyte does not warrant that the functions contained in the software will meet customer's requirements, that software will be free from defects or that the operation of the software will be uninterrupted or error free. Software is provided on an "AS IS" basis.

EXCEPT FOR THE EXPRESS WARRANTY STATED ABOVE, EXABYTE MAKES NO OTHER WARRANTIES, WHETHER EXPRESS OR IMPLIED, WITH RESPECT TO THIS EXABYTE PRODUCT. ALL IMPLIED WARRANTIES, INCLUDING THOSE OF MERCHANTABILITY AND FITNESS FOR A PARTICULAR PURPOSE ARE EXPRESSLY DISCLAIMED.

EXABYTE DOES NOT WARRANT THAT PRODUCT WILL MEET ALL OF PURCHASER'S REQUIREMENTS OR THAT OPERATION OF PRODUCTS WILL BE UNINTERRUPTED OR ERROR FREE.

Exabyte shall have no liability or responsibility to Purchaser or any other person for any loss or damage or any special, incidental or consequential damages caused or alleged to be caused directly or indirectly by Product or those items supplied or sold by Exabyte hereunder, including, but not limited to, any interruption of service, loss of data, loss of customer goodwill, loss of business, anticipatory profits or consequential damages resulting from the use or operation of the Product.

In no event shall Exabyte be liable for loss of profits or any indirect, special, incidental, or consequential damages arising out of any breach of this warranty or in any manner arising out of or connected with the sale or anticipated use of the product. In no event shall Exabyte be liable for any damages whatsoever in excess of the purchase price of the Product. This warranty gives you specific legal rights, and you may also have other rights that vary from state to state. Some states do not allow the exclusion or limitation of incidental or consequential damages, so the above limitation or exclusion may not apply to you. For products sold in North America, the warranty term is one year. Outside North America, the Product Warranty term is three years.

Go to [www.exabyte.com/warranty](http://www.exabyte.com/warranty) for current limited warranty terms and conditions.

## ON SITE SERVICE (OSS)

OSS is provided for the first year at no charge in North America. OSS is available Monday-Friday, 8AM-5PM OSS (next business day) 7AM-6PM MST Technical Support is provided in an effort to keep Product in, or return Product to, good working order. Exabyte shall, at its option, repair or replace Product, including spare parts. OSS does not assure uninterrupted operation of Customer's Product or guarantee that Product can be returned to good working order. OSS includes the replacement of defective parts. Unless specified otherwise, OSS shall be performed during normal business hours of 8:00 a.m. to 5:00 local time, excluding Exabyte holidays. OSS does not cover accessories or consumable parts and supplies, missing parts, or those items identified by the manufacturer as being Customer's responsibility, nor does it cover Product installation, relocation services, systems engineering services, programming, reinstallation of Customer's operating system or application software, firmware or code updates, or operational procedures of any sort. Customer shall provide Exabyte with full and free access to Product to allow Exabyte to perform OSS.

Exabyte requires a credit card number prior to shipping an OSS unit. **You must agree to ship the original unit back to Exabyte, using the OSS packaging which includes the return ship label, within 10 calendar days from the time you receive your replacement.** If Exabyte does not receive your original unit within 10 days we will charge your credit card for the OSS unit at the retail purchase price.

## ADVANCED EXCHANGE SERVICE OPTION

The ADvanced EXchange (ADEX) Service is available at no charge during the first year of the warranty period for customers needing a replacement unit at the time they receive a Return Material Authorization (RMA) number from Exabyte Service Support.

With the ADvanced EXchange Service option, Exabyte will ship a completely reconditioned replacement unit (same configuration as customer's purchased unit) to the customer before receiving the defective unit back from the customer. This ADEX unit will become the customer's unit; Exabyte will not return the original unit to the customer. The remaining warranty on the original unit will apply to the ADEX unit.

The ADEX unit will usually ship within 48 hours, subject to availability. Although Exabyte will ship the ADEX unit to you by best way, Exabyte cannot guarantee the arrival of the ADEX unit on the following business day. Exabyte can provide waybill numbers so you can work with the carrier on any delivery problems. All deliveries shall be F.O.B. Exabyte's shipping point.

Exabyte requires a credit card number prior to shipping an ADEX unit. **You must agree to ship the original unit back to Exabyte, using the ADEX packaging which includes the return ship label, within 10 calendar days from the time you receive your replacement.** If Exabyte does not receive your original unit within 10 days we will charge your credit card for the ADEX unit at the retail purchase price.

**The ADEX Service Option is available in North America, Australia, and Europe and applies to Exabyte-branded products purchased from authorized Exabyte resellers only.**

To take advantage of the ADvanced EXchange Service Option you need only ask for the ADEX option when speaking to the Service Support representative while processing your RMA.

For more information about Exabyte Service Support, see [www.exabyte.com/warranty](http://www.exabyte.com/warranty).

EXABYTE CORPORATION  
2108 55TH STREET  
BOULDER, COLORADO 80301 USA  
(303) 442-4333

## NOTES

## Free Manuals Download Website

<http://myh66.com>

<http://usermanuals.us>

<http://www.somanuals.com>

<http://www.4manuals.cc>

<http://www.manual-lib.com>

<http://www.404manual.com>

<http://www.luxmanual.com>

<http://aubethermostatmanual.com>

Golf course search by state

<http://golfingnear.com>

Email search by domain

<http://emailbydomain.com>

Auto manuals search

<http://auto.somanuals.com>

TV manuals search

<http://tv.somanuals.com>