



Excalibur Electronics

Mini Cooper **Full Function Radio Control Car** **1:8 Scale**

Instruction Manual

www.ExcaliburElectronics.com

Model No. 9366

MINI COOPER Model No. 9366

1:8 SCALE
For over 7 years of age

EXCALIBUR

Instruction Manual

9.6V FULL FUNCTION RADIO CONTROL

PLEASE BE SURE TO REMOVE ALL ACCESSORIES AND COMPONENTS FROM THE PACKAGING.

Charging the battery:

Insert the charger plug into a suitable household outlet.
Connect the battery pack to the charger clip.

Charging time - First charge 7 hours (not more than 8 hours)
- Recharge 4 hours.

- REMARKS:**
1. New battery packs need charging and a pack will be fully charged after 7 hours.
 2. Extended charging does not improve or increase running time.
 3. 4 hours is required for recharging the battery.
 4. After charging, please disconnect the battery pack and unplug the charger.
 5. The battery pack can be charged up to 1001 times.
 6. The running time is between 20-30 minutes, but can vary from 10-20 minutes depending on the terrain and the size, weight and speed of the vehicle.
 7. The vehicle will slow down and stop when the battery is drained. Wait for 20-25 minutes for the pack to cool. Remove from the vehicle and then re-charge.

CAUTION !

1. Leakage may occur if the battery is not used for an extended period of time.
2. Be careful when disconnecting the unit as improper handling may damage the unit.
3. We suggest that you wait for 20-25 minutes after use before recharging the battery pack. This will give the battery pack time to cool off.
4. Recharging a warm battery pack will shorten its life.
5. Keep the unit away from fire or high temperatures.
6. Do not charge leaking or damaged batteries.
7. Unplug the battery pack when not in use.
8. Do not dispose of the battery pack in a fire as this may cause an explosion and serious injury.
9. Dispose of NiCd batteries properly. Do not disassemble the batteries.
10. You must always remove the battery pack from the vehicle prior to charging.
11. The battery charger is not for any other use except as instructed.
12. We suggest that adults periodically check the wires and plugs.

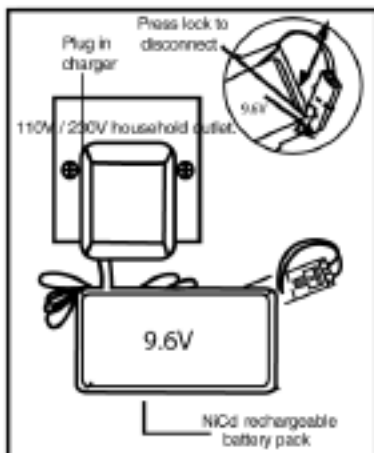

OPERATION-

Switch the vehicle "ON." The indicator light will come on, but if it doesn't, check the batteries.
Extend the antenna to its full length.
Switch off the vehicle and the transmitter after use. Remove the 9V battery and rechargeable pack for storage.

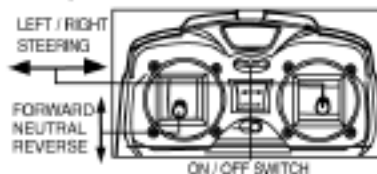

TRIM SWITCH CONTROL

The switch is located on the underside of the vehicle between the two front wheels and is used to align the wheels for consistent straight-line driving.

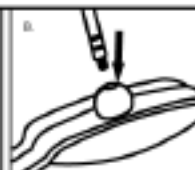
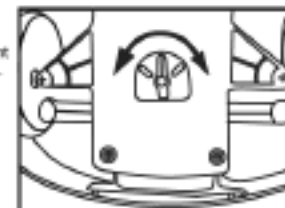

TRANSMITTER BATTERY INSTALLATION AND ASSEMBLY

1. Install the 9V battery into the transmitter.
2. In a clockwise direction, screw the threaded end of the antenna into the cavity located on top of the transmitter. The antenna should have a light fit for good transmission.

OPERATION

1. Switch the vehicle "ON," the switch is located on the underside of the vehicle. It is now ready to run.

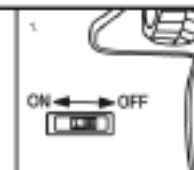

The BMW logo, the BMW wordmark and the BMW model designations are trademarks of BMW Group and are used under license.

HINTS FOR MAINTENANCE

Interference from radio waves may affect the behavior of the vehicle. Special care for your vehicle is mentioned below.

Do not abuse your vehicle.

- Avoid heat, water, sand and high impact collisions. Off-road vehicles run easily on grassy surfaces.
- Avoid using the vehicle on wet surfaces.
- Avoid using the vehicle on sandy or dusty areas.
- Avoid using the vehicle for long periods under direct sunlight. Sunlight or excessive heat may damage sensitive or electronic instruments.
- Store the vehicle transmitter in a dry, cool place away from heaters or warm areas.
- Collisions with hard surfaces may damage the vehicle.
- The vehicle cannot operate on thick carpets or dusty floors.
- If you wish to operate more than one vehicle at the same time, you must purchase another vehicle on another frequency.
- Always brush your vehicle after use to remove dust, dirt, or other foreign objects. Keep the vehicle clean.
- Clean using only a soft rag or cloth. Avoid cleaning the vehicle with water or any chemical agents.

TROUBLE SHOOTING :

IF THE VEHICLE DOES NOT MOVE:

1. Are the battery contacts correctly matched in the transmitter?
2. Are the metal contact tabs touching, rusty or dirty in the transmitter?
3. Are there batteries in the transmitter?
4. Is the power switch on the transmitter turned on?
5. Are the batteries exhausted?

IF THE VEHICLE RUNS SLOWLY:

1. Are the batteries in the vehicle and transmitter worn out ?
2. Is there something obstructing the movement of the vehicle ?

POWER PACK

For the highest performance, we recommend that you start with a fully charged pack. During installation, make sure that the connector plugs are securely locked. When disconnecting, do not pull the wire as it may short circuit the system.

RANGE

When the vehicle goes beyond radio signal contact, loss of control or slowness will occur. Extend the transmitting antenna higher for recontact. Make sure the antenna is screwed on tightly for a good fit.

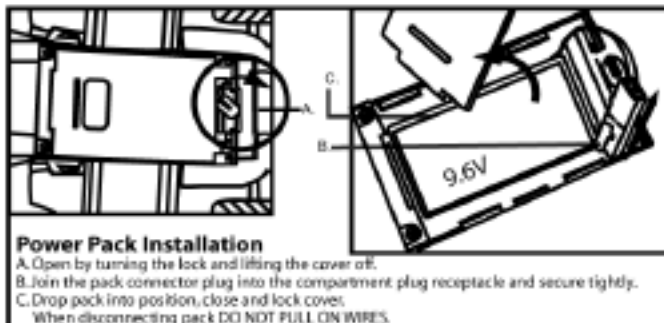

Power Pack Installation

1. Open by turning the lock and lifting the cover off.
 2. Join the pack connector plug into the compartment plug receptacle and secure tightly.
 3. Drop pack into position, close and lock covers.
- When disconnecting pack DO NOT PULL ON WIRES.



INSTALLATION OF VEHICLE ANTENNA

1. Insert the antenna wire through the plastic tube.
2. Insert the tube into the hole of the vehicle.
3. Tie a knot at the end of the wire to secure it.

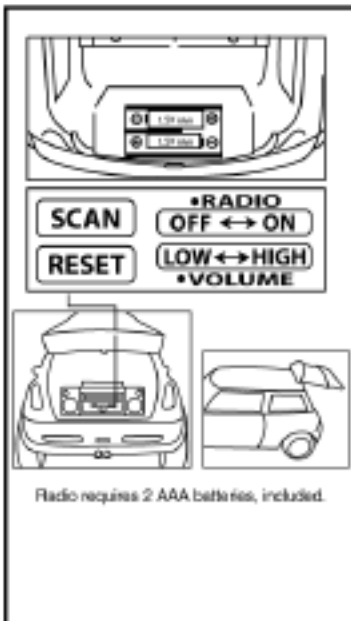

NOTE: This equipment has been tested and found to comply with the limits for a Class B digital device, pursuant to Part 15 of FCC Rules and R&TTE Directive 1999/5/EC. These limits are designed to provide reasonable protection against harmful interference in a residential installation. This equipment generates, uses and can radiate radio frequency energy and, if not installed and used in accordance with the instructions, may cause harmful interference with radio communications.

However, there is no guarantee that interference will not occur in a particular installation. If this equipment does cause harmful interference to radio or television reception, which can be determined by turning the equipment off and on, the user is encouraged to try to correct the interference by one or more of the following measures:

- Reorient or relocate the receiving antenna.
- Increase the separation between the equipment and receiver.
- Connect the equipment and the receiver into different outlets.
- Consult the dealer or an experienced radio/TV technician for help.

THIS PRODUCT IS FOR USE IN U.K., SPAIN, GERMANY, FRANCE, BELGIUM, ITALY, SWITZERLAND, CANADA, THE NETHERLANDS, DENMARK, PORTUGAL AND U.S.

For Transmitter



Excalibur Electronics, Inc.
13755 SW 119th Avenue
Miami, Florida 33186
Phone: (305) 477-8080
Fax: (305) 477-9516
www.ExcaliburElectronics.com

CE 0197

Battery Information

- CAUTION: Batteries should be removed and replaced by adults only.
- Turn unit off when installing batteries.
- Mini Cooper uses 1 9.6V, 1 9V and 2 AAA batteries, included.
- Do not mix alkaline, standard (carbon-zinc) or rechargeable (nickel-cadmium) batteries.
- Do not mix old and new batteries.
- Do not use rechargeable batteries.
- Remove exhausted batteries from the unit.
- Do not short circuit battery terminals.
- Remove batteries and store them in a cool, dry place when not in use.
- To avoid explosion or leakage, do not dispose of batteries in a fire or attempt to recharge alkaline or other non-rechargeable batteries.
- Install batteries so that the polarity (+ and -) matches the diagram in the battery compartment.
- Use only batteries of the same type and equivalency.

Limited 90-Day Warranty

EXCALIBUR ELECTRONICS, INC., warrants to the original consumer that its products are free from any electrical or mechanical defects for a period of 90 DAYS from the date of purchase. If any such defect is discovered within the warranty period, EXCALIBUR ELECTRONICS, INC., will repair or replace the unit free of charge upon receipt of the unit, shipped postage prepaid and insured to the factory address shown at right.

The warranty covers normal consumer use and does not cover damage that occurs in shipment or failure that results from alterations, accident, misuse, abuse, neglect, wear and tear, inadequate maintenance, commercial use, or unreasonable use of the unit. Removal of the top panel voids all warranties. This warranty does not cover cost of repairs made or attempted outside of the factory.

Any applicable implied warranties, including warranties of merchantability and fitness, are hereby limited to 90 DAYS from the date of purchase. Consequential or incidental damages resulting from a breach of any applicable express or implied warranties are hereby excluded. Some states do not allow limitations on the duration of implied warranties and do not allow exclusion of incidental or consequential damages, so the above limitations and exclusions in

these instances may not apply.

The only authorized service center in the United States is:

Excalibur Electronics, Inc.
13755 SW 119th Ave
Miami, Florida 33186 U.S.A.
Phone: 305.477.8080
Fax: 305.477.9516

Play games live at:
www.ExcaliburElectronics.com

Ship the unit carefully packed, preferably in the original carton, and send it prepaid, and adequately insured. Include a letter, detailing the complaint and including your daytime telephone number, inside the shipping carton.

If your warranty has expired and you want an estimated fee for service, write to the above address, specifying the model and the problem.

PLEASE DO NOT SEND
YOUR UNIT WITHOUT
RECEIVING AN ESTIMATE FOR SERVICING.
WE CANNOT
STORE YOUR UNIT!

Due to continuing improvements,
actual product may differ slightly
from the product described herein.

Free Manuals Download Website

<http://myh66.com>

<http://usermanuals.us>

<http://www.somanuals.com>

<http://www.4manuals.cc>

<http://www.manual-lib.com>

<http://www.404manual.com>

<http://www.luxmanual.com>

<http://aubethermostatmanual.com>

Golf course search by state

<http://golfingnear.com>

Email search by domain

<http://emailbydomain.com>

Auto manuals search

<http://auto.somanuals.com>

TV manuals search

<http://tv.somanuals.com>