

PowerCage FOX 4G Tx/Rx DVI and VGA Setup Guide

This guide provides instructions for an experienced installer to set up and operate the Extron® PowerCage FOX 4G Tx/Rx DVI and PowerCage FOX 4G Tx/Rx VGA fiber optic video and audio extenders.

NOTES: PowerCage transmitters (Tx) can output signals to any PowerCage Fox 4G, FOXBOX 4G, or FOX 500 VGA or DVI device.
PowerCage receivers (Rx) can accept signals from any PowerCage 4G, FOXBOX 4G, or FOX 500 VGA or DVI device.

IMPORTANT:
Refer to www.extron.com for the complete user manual and installation instructions before connecting the product to the power source.

Installation

Step 1 — Mounting

Install the Tx, Rx, or both in PowerCage enclosures as required.

NOTES:

- PowerCage boards are hot-swappable.
- Ensure the boards are flush with the rear of the enclosure and the screws tightened securely before applying power.

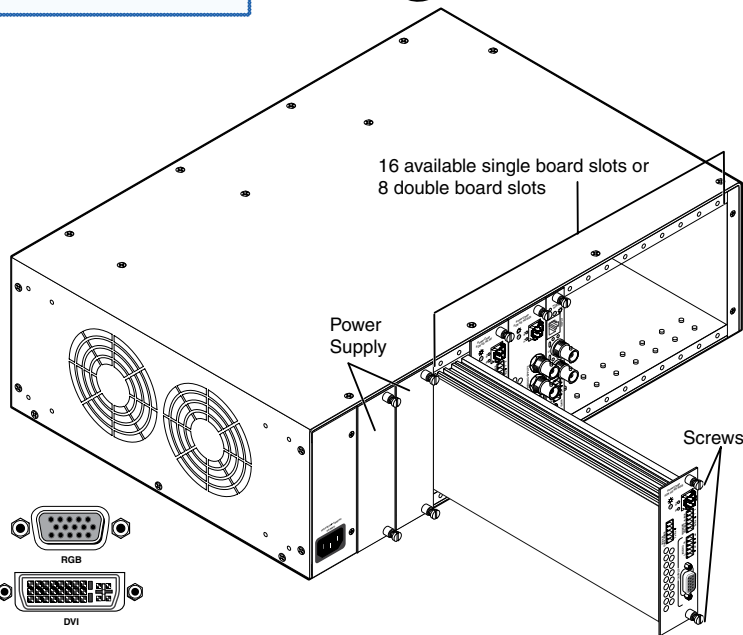

Step 2 — Input and Output Connections

- Connect an RGB or DVI video source to the Input connector on the transmitter.
- Connect an RGB or DVI display to the Output connector on the receiver.
- Connect a balanced or unbalanced, stereo or mono audio input to the transmitter via the Audio Input captive screw connector and a balanced or unbalanced stereo or mono audio device to the receiver via the Audio Output captive screw connector. See the drawing below.

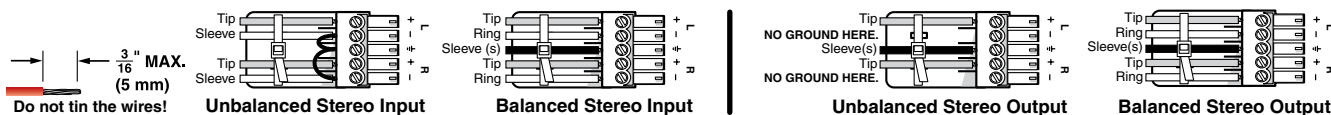

CAUTION: For unbalanced audio, connect the sleeves to the ground contact. **DO NOT** connect the sleeves to the negative (-) contacts).

- If you want the PowerCage FOX 4G units to pass serial data or control signals, such as for serial control of a projector, connect the master device to the transmitter and the slave device to the receiver via the first three poles of the RS-232 Over Fiber captive screw connectors on **both** units.

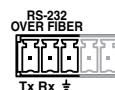

NOTE: For RS-232 responses (from the receiver to the transmitter), you must install the cable in step 2d and leave the receiver in normal configuration.

- For serial control of the transmitter and receiver, connect a host device, such as a computer, to the Remote RS-232 port on **either** unit via three poles (Tx, Rx, and \oplus) of the Remote RS-232/Alarm 5-pole captive screw connector on either unit. The protocol for these ports is as follows:

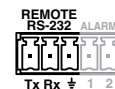

- 9600 baud
- no parity
- 8 data bits
- 1 stop bit
- no flow control

Refer to the *PowerCage FOX 4G Tx/Rx User Guide* for detailed information about using the Simple Instruction Set (SIS™) commands and the Windows®-based FOX Extender program to set up and operate the transmitter and receiver and to take advantage of the various adjustments and test patterns available on the PowerCage FOX 4G units.

- For remote monitoring of the status of the Rx optical link on either the transmitter or receiver, connect a locally constructed or obtained device to the two Alarm poles of the Remote RS-232/Alarm 5-pole captive screw connector on that unit. The two poles are shorted together when no light is detected.

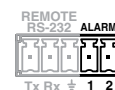

PowerCage FOX 4G Tx/Rx DVI and VGA Setup Guide (Continued)

Step 3 — Throughput Connections

NOTE: See the two fiber cable connection drawings below. You can connect the transmitter and one or more receivers in one of three ways:

- One way (transmitter to receiver) only, perform step 3a.
- Two way (transmitter to receiver and return), perform steps 3a and 3b.
- One way (transmitter to receiver) with daisy chain (receiver to receiver), perform steps 3a and 3c.

- Connect the fiber between the Tx port on the transmitter and the Rx port on the receiver.
- If you want the receiver to send return serial data (such as responses from a controlled device) to the transmitter, connect a cable between the receiver's Tx and transmitter's Rx ports.
- If you want a receiver to daisy chain the optical signal to another receiver (up to 10 receivers in a daisy chain):
 - Connect the receiver's Tx fiber cable to Rx on another receiver.
 - Set each receiver to daisy chain mode. See [Normal and Daisy Chain Modes](#), below.

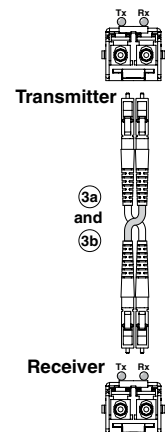
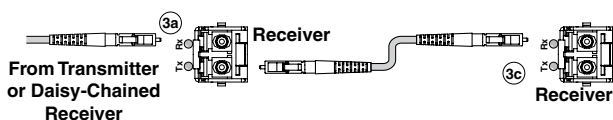

Step 4 — PowerCage Configuration Port

If desired, connect a host device to PowerCage enclosure Configuration connector via the 9-pin D to 2.5 mm mini jack TRS RS-232 cable that is included with the PowerCage enclosure or available separately using part #70-335-01. Repeatedly press the Comm Select button until the Comm LED lights for the slot where the transmitter or receiver is installed. The protocol for this port is as follows:

- 9600 baud
- no parity
- 8 data bits
- 1 stop bit
- no flow control

Refer to the *PowerCage FOX 4G Tx/Rx User Guide* for detailed information about using the SIS commands and the Windows®-based FOX Extender program to set up and operate the transmitter and receiver and to take advantage of the various adjustments and test patterns available on the PowerCage FOX 4G units.

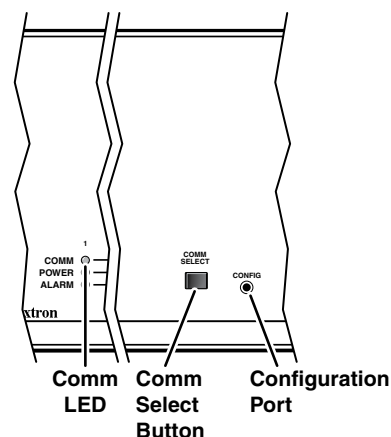

Operation

After all receivers, the transmitter, and their connected devices are powered up, the system is fully operational. If any problems are encountered, verify that the cables are routed and connected properly and that all display devices have identical resolutions and refresh rates. If your problems persist, call the Extron S³ Sales & Technical Support Hotline at the number shown below that is closest to you.

Normal and Daisy Chain Modes

The receiver operates on one of two modes:

- **Normal mode** — The receiver outputs RS-232 and SIS commands and responses on its Tx LC connector.
- **Daisy chain mode** — The receiver daisy chains its Rx connector input through to its Tx connector output.

Use SIS commands issued to the connected unit to toggle between normal and daisy chain modes. Connect a PC to the Remote RS-232 port of either unit or to the Configuration port on the PowerCage enclosure and issue the following command:

66*0*n#

where:

- $n = 2$ = enable daisy chain mode
- $n = 1$ or 0 = disable daisy chain mode

NOTE: Up to 10 receivers, each in daisy chain mode, can be connected in a daisy chain to a single transmitter.

Extron **USA - West**
Headquarters
+800.633.9876
Inside USA / Canada Only
+1.714.491.1500
+1.714.491.1517 FAX

Extron **USA - East**
+800.3987.6676
Inside USA / Canada Only
+1.919.863.1794
+1.919.863.1797 FAX

Extron **Europe**
+800.3987.6676
Inside Europe Only
+31.33.453.4040
+31.33.453.4050 FAX

Extron **Asia**
+800.7339.8766
Inside Asia Only
+65.6383.4400
+65.6383.4664 FAX

Extron **Japan**
+81.3.3511.7655
+81.3.3511.7656 FAX

Extron **China**
+400.883.1568
Inside China Only
+86.21.3760.1568
+86.21.3760.1566 FAX

Extron **Middle East**
+971.4.2991800
+971.4.2991880 FAX

68-1911-50
Rev **A**
05 10 **2**

Free Manuals Download Website

<http://myh66.com>

<http://usermanuals.us>

<http://www.somanuals.com>

<http://www.4manuals.cc>

<http://www.manual-lib.com>

<http://www.404manual.com>

<http://www.luxmanual.com>

<http://aubethermostatmanual.com>

Golf course search by state

<http://golfingnear.com>

Email search by domain

<http://emailbydomain.com>

Auto manuals search

<http://auto.somanuals.com>

TV manuals search

<http://tv.somanuals.com>