

Setup Guide

For complete user's manual
go to
www.extron.com



VersaTools® MTP Series Video and Audio Mini Twisted Pair Transmitters and Receivers

Precautions

Safety Instructions • English



This symbol is intended to alert the user of important operating and maintenance (servicing) instructions in the literature provided with the equipment.



This symbol is intended to alert the user of the presence of uninsulated dangerous voltage within the product's enclosure that may present a risk of electric shock.

Caution

Read Instructions • Read and understand all safety and operating instructions before using the equipment.

Retain Instructions • The safety instructions should be kept for future reference.

Follow Warnings • Follow all warnings and instructions marked on the equipment or in the user information.

Avoid Attachments • Do not use tools or attachments that are not recommended by the equipment manufacturer because they may be hazardous.

Consignes de Sécurité • Français



Ce symbole sert à avertir l'utilisateur que la documentation fournie avec le matériel contient des instructions importantes concernant l'exploitation et la maintenance (réparation).



Ce symbole sert à avertir l'utilisateur de la présence dans le boîtier de l'appareil de tensions dangereuses non isolées posant des risques d'électrocution.

Attention

Lire les instructions • Prendre connaissance de toutes les consignes de sécurité et d'exploitation avant d'utiliser le matériel.

Conservier les instructions • Ranger les consignes de sécurité afin de pouvoir les consulter à l'avenir.

Respecter les avertissements • Observer tous les avertissements et consignes marqués sur le matériel ou présents dans la documentation utilisateur.

Éviter les pièces de fixation • Ne pas utiliser de pièces de fixation ni d'outils non recommandés par le fabricant du matériel car cela risquerait de poser certains dangers.

Sicherheitsanleitungen • Deutsch



Dieses Symbol soll dem Benutzer in der im Lieferumfang enthaltenen Dokumentation besonders wichtige Hinweise zur Bedienung und Wartung (Instandhaltung) geben.



Dieses Symbol soll den Benutzer darauf aufmerksam machen, daß im Inneren des Gehäuses dieses Produktes gefährliche Spannungen, die nicht isoliert sind und die einen elektrischen Schock verursachen können, herrschen.

Achtung

Lesen der Anleitungen • Bevor Sie das Gerät zum ersten Mal verwenden, sollten Sie alle Sicherheits- und Bedienungsanleitungen genau durchlesen und verstehen.

Aufbewahren der Anleitungen • Die Hinweise zur elektrischen Sicherheit des Produktes sollten Sie aufbewahren, damit Sie im Bedarfsfall darauf zurückgreifen können.

Befolgen der Warnhinweise • Befolgen Sie alle Warnhinweise und Anleitungen auf dem Gerät oder in der Benutzerdokumentation.

Keine Zusatzgeräte • Verwenden Sie keine Werkzeuge oder Zusatzgeräte, die nicht ausdrücklich vom Hersteller empfohlen wurden, da diese eine Gefahrenquelle darstellen können.

Instrucciones de seguridad • Español



Este símbolo se utiliza para advertir al usuario sobre instrucciones importantes de operación y mantenimiento (o cambio de partes) que se desean destacar en el contenido de la documentación suministrada con los equipos.



Este símbolo se utiliza para advertir al usuario sobre la presencia de elementos con voltaje peligroso sin protección aislante, que puedan encontrarse dentro de la caja o alojamiento del producto, y que puedan representar riesgo de electrocución.

Precución

Leer las instrucciones • Leer y analizar todas las instrucciones de operación y seguridad, antes de usar el equipo.

Conservar las instrucciones • Conservar las instrucciones de seguridad para futura consulta.

Obedecer las advertencias • Todas las advertencias e instrucciones marcadas en el equipo o en la documentación del usuario, deben ser obedecidas.

Evitar el uso de accesorios • No usar herramientas o accesorios que no sean específicamente recomendados por el fabricante, ya que podrían implicar riesgos.

Warning

Power sources • This equipment should be operated only from the power source indicated on the product. This equipment is intended to be used with a main power system with a grounded (neutral) conductor. The third (grounding) pin is a safety feature, do not attempt to bypass or disable it.

Power disconnection • To remove power from the equipment safely, remove all power cords from the rear of the equipment, or the desktop power module (if detachable), or from the power source receptacle (wall plug).

Power cord protection • Power cords should be routed so that they are not likely to be stepped on or pinched by items placed upon or against them.

Servicing • Refer all servicing to qualified service personnel. There are no user-serviceable parts inside. To prevent the risk of shock, do not attempt to service this equipment yourself because opening or removing covers may expose you to dangerous voltage or other hazards.

Slots and openings • If the equipment has slots or holes in the enclosure, these are provided to prevent overheating of sensitive components inside. These openings must never be blocked by other objects.

Lithium battery • There is a danger of explosion if battery is incorrectly replaced. Replace it only with the same or equivalent type recommended by the manufacturer. Dispose of used batteries according to the manufacturer's instructions.

Avertissement

Alimentations • Ne faire fonctionner ce matériel qu'avec la source d'alimentation indiquée sur l'appareil. Ce matériel doit être utilisé avec une alimentation principale comportant un fil de terre (neutre). Le troisième contact (de mise à la terre) constitue un dispositif de sécurité : n'essayez pas de la contourner ni de la désactiver.

Déconnexion de l'alimentation • Pour mettre le matériel hors tension sans danger, déconnectez tous les cordons d'alimentation de l'arrière de l'appareil ou du module d'alimentation de bureau (s'il est amovible) ou encore de la prise secteur.

Protection du cordon d'alimentation • Achémener les cordons d'alimentation de manière à ce que personne ne risque de marcher dessus et à ce qu'ils ne soient pas écrasés ou pincés par des objets.

Réparation-maintenance • Faire exécuter toutes les interventions de réparation-maintenance par un technicien qualifié. Aucun des éléments internes ne peut être réparé par l'utilisateur. Afin d'éviter tout danger d'électrocution, l'utilisateur ne doit pas essayer de procéder lui-même à ces opérations car l'ouverture ou le retrait des couvercles risquent de l'exposer à de hautes tensions et autres dangers.

Fentes et orifices • Si le boîtier de l'appareil comporte des fentes ou des orifices, ceci sert à empêcher les composants internes sensibles de surchauffer. Ces ouvertures ne doivent jamais être bloquées par des objets.

Lithium Batterie • Il a danger d'explosion s'il y a un remplacement incorrect de la batterie. Remplacer uniquement avec une batterie du même type ou d'un équivalent recommandé par le constructeur. Mettre au rebut les batteries usagées conformément aux instructions du fabricant.

Vorsicht

Stromquellen • Dieses Gerät sollte nur über die auf dem Produkt angegebene Stromquelle betrieben werden. Dieses Gerät wurde für eine Verwendung mit einer Hauptstromleitung mit einem geerdeten (neutralen) Leiter konzipiert. Der dritte Kontakt ist für einen Erdschluß, und stellt eine Sicherheitsfunktion dar. Diese sollte nicht umgangen oder außer Betrieb gesetzt werden.

Stromunterbrechung • Um das Gerät auf sichere Weise vom Netz zu trennen, sollten Sie alle Netzkabel aus der Rückseite des Gerätes, aus der externen Stromversorgung (falls dies möglich ist) oder aus der Wandsteckdose ziehen.

Schutz des Netzkabels • Netzkabel sollten stets so verlegt werden, daß sie nicht im Weg liegen und niemand darauf treten kann oder unmittelbar dagegen gestellt werden können.

Wartung • Alle Wartungsmaßnahmen sollten nur von qualifiziertem Servicepersonal durchgeführt werden. Die internen Komponenten des Gerätes sind wartungsfrei. Zur Vermeidung eines elektrischen Schocks versuchen Sie in keinem Fall, dieses Gerät selbst öffnen, da beim Entfernen der Abdeckungen die Gefahr eines elektrischen Schlags und/oder anderer Gefahren bestehen.

Schlitze und Öffnungen • Wenn das Gerät Schlitze oder Löcher im Gehäuse aufweist, dienen diese zur Vermeidung einer Überhitzung der empfindlichen Teile im Inneren. Diese Öffnungen dürfen niemals von anderen Objekten blockiert werden.

Lithium-Batterie • Explosionsgefahr, falls die Batterie nicht richtig ersetzt wird. Ersetzen Sie verbrauchte Batterien nur durch den gleichen oder einen vergleichbaren Batterietyp, der auch vom Hersteller empfohlen wird. Entsorgen Sie verbrauchte Batterien bitte gemäß den Herstelleranweisungen.

Advertencia

Alimentación eléctrica • Este equipo debe conectarse únicamente a la fuente/tipo de alimentación eléctrica indicada en el mismo. La alimentación eléctrica de este equipo debe provenir de un sistema de distribución general con conductor neutro a tierra. La tercera pata (puesta a tierra) es una medida de seguridad, no puentearla ni eliminarla.

Desconexión de alimentación eléctrica • Para desconectar con seguridad la conectada de alimentación eléctrica al equipo, desconectar todos los cables de alimentación en el panel trasero del equipo, o desenchufar el módulo de alimentación (si fuera independiente), o desenchufar el cable del receptáculo de la pared.

Protección del cables de alimentación • Los cables de alimentación eléctrica se deben instalar en lugares donde no sean pisados ni apretados por objetos que se puedan apoyar sobre ellos.

Reparaciones/mantenimiento • Solicitar siempre los servicios técnicos de personal calificado. En el interior no hay partes a las que el usuario debe acceder. Para evitar riesgo de electrocución, no intentar personalmente la reparación/mantenimiento de este equipo, ya que al abrir o extraer las tapas puede quedar expuesto a voltajes peligrosos u otros riesgos.

Ranuras y aberturas • Si el equipo posee ranuras o orificios en su caja/alojamiento, es para evitar el sobrecalentamiento de componentes internos sensibles. Estas aberturas nunca se deben obstruir con otros objetos.

Batería de litio • Existe riesgo de explosión si esta batería se coloca en la posición incorrecta. Cambiar esta batería únicamente con el mismo tipo (o su equivalente) recomendado por el fabricante. Desachar las baterías usadas siguiendo las instrucciones del fabricante.

Precautions, cont'd

安全须知 • 中文



这个符号提示用户该设备用户手册中有重要的操作和维护说明。



这个符号警告用户该设备机壳内有暴露的危险电压，有触电危险。

注意

阅读说明书 • 用户使用该设备前必须阅读并理解所有安全和使用说明。

保存说明书 • 用户应保存安全说明书以备将来使用。

遵守警告 • 用户应遵守产品和用户指南上的所有安全和操作说明。

避免追加 • 不要使用该产品厂商没有推荐的工具或追加设备，以避免危险。

警告

电源 • 该设备只能使用产品上标明的电源。设备必须使用有地线的供电系统供电。第三条线（地线）是安全设施，不能不用或跳过。

拔掉电源 • 为安全地从设备拔掉电源，请拔掉所有设备后或桌面电源的电源线，或任何接到市电系统的电源线。

电源线保护 • 妥善布线，避免被踩踏，或重物挤压。

维护 • 所有维修必须由认证的维修人员进行。设备内部没有用户可以更换的零件。为避免出现触电危险不要自己试图打开设备盖子维修该设备。

通风孔 • 有些设备机壳上有通风槽或孔，它们是用来防止机内敏感元件过热。不要用任何东西挡住通风孔。

锂电池 • 不正确的更换电池会有爆炸的危险。必须使用与厂家推荐的相同或相近型号的电池。按照生产厂的建议处理废弃电池。

FCC Class A Notice

This equipment has been tested and found to comply with the limits for a Class A digital device, pursuant to part 15 of the FCC Rules. Operation is subject to the following two conditions: (1) this device may not cause harmful interference, and (2) this device must accept any interference received, including interference that may cause undesired operation. The Class A limits are designed to provide reasonable protection against harmful interference when the equipment is operated in a commercial environment. This equipment generates, uses, and can radiate radio frequency energy and, if not installed and used in accordance with the instruction manual, may cause harmful interference to radio communications. Operation of this equipment in a residential area is likely to cause harmful interference, in which case the user will be required to correct the interference at his own expense.

NOTE

This unit was tested with shielded cables on the peripheral devices. Shielded cables must be used with the unit to ensure compliance with FCC emissions limits.



Table of Contents

Chapter One • Installation	1-1
About the MTP Transmitters and Receivers	1-2
Signal Jumpers for Generational Compatibility	1-3
Mounting Options	1-4
Frame mounting (AAP models)	1-4
Furniture or projector mounting (except AAP models)	1-4
Rack mounting (all except AAP models)	1-4
Rack mounting instructions	1-4
Tabletop use (all except AAP models)	1-4
UL Guidelines	1-4
Panel Features and Connections	1-5
Power connection (all models)	1-8
Receiver output connections	1-10
Transmitter input connections	1-5
Transmitter/receiver throughput connections	1-7
Twisted Pair cable termination	1-7
Chapter Two • Operation	2-1
Front Panel Features	2-2
Troubleshooting — Skew Delay Compensation	2-2
Appendix A • Reference Information	A-1
Specifications	A-2
Part Numbers	A-2
AAP accessories	A-3
Accessories	A-2
Cables/connectors	A-4
MTP receivers	A-3
MTP transmitters	A-3
Skew compensation solutions	A-4

Table of Contents, cont'd

All trademarks mentioned in this manual are the properties of their respective owners.

68-732-50 Rev. A
09 08



VersaTools® MTP Series Series

1 Chapter One

Installation

About the MTP Transmitters and Receivers

Signal Jumpers for Generational Compatibility

Mounting Options

Panel Features and Connections

Installation

About the MTP Transmitters and Receivers

The Extron MTP transmitters and receivers provide a system for long-distance distribution of A/V signals over Category (CAT) 5 shielded (STP), unshielded (UTP), or foil shielded (FTP) twisted pair cable. They are part of the Extron VersaTools® line of basic distribution amplifiers, switchers, transmitters, receivers, and associated video accessories.

An MTP transmitter converts input video and stereo or mono audio signals to proprietary signals and outputs them to a compatible MTP receiver via TP (twisted pair) cabling.

The MTP Series Features table shows the video and audio capabilities of each model, transmitter/receiver compatibility, and Architectural Adapter Plate (AAP) mountability.

		MTP Series Features				
		Video Format	Audio Connection		mounted	AAP
Transmitters	S-video	Composite video	Captive screw	RCA	mounted	AAP
	MTP T SV	●				
MTP T SV A	●		●			
MTP T SV A RCA	●			●		
MTP T SVA AAP	●			●		●
MTP T CV		●				
MTP T AV		●	●			
MTP T AV RCA		●		●		
MTP T AV AAP		●		●		●
Receivers						
MTP R SV	●					
MTP R SV A	●		●			
MTP R SV A RCA	●			●		
MTP R CV		●				
MTP R AV		●	●			
MTP R AV RCA		●		●		

NOTE The video format of the transmitter (S-video or composite video) must match the video format of the receiver.

NOTE The transmitter audio output, whether captive screw or RCA input connectors, is compatible with any receiver in the MTP Series if the transmitter and receiver jumper configuration is compatible. See "Signal Jumpers for Generational Compatibility".

Signal Jumpers for Generational Compatibility

The latest generation MTP transmitters convert stereo audio to mono before outputting it to the receiver. Remote powering of either the transmitter or receiver has also been eliminated. While the default setup of a new generation (mono audio) MTP transmitter/receiver is not compatible with older generation (stereo audio) units, internal jumpers provide backward compatibility and also allow new generation units to utilize the two features (stereo audio and remote powering) when necessary.

Shift the **new** transmitter and/or receiver jumper **if**:

- The installation mixes a transmitter/receiver pair with stereo and mono audio (old and new generation).
- Stereo audio is required.
- Remote power is needed.

The table below identifies the generation of transmitter and/or receiver. If any of the above scenarios are true, consult the *VersaTools MTP Series User's Manual* or www.extron.com for instructions on properly setting the jumper.

NOTE *Only new generation units have jumpers.*

Transmitter	Old generation (stereo audio)	New generation (mono audio)
MTP T SV	60-540-02	60-540-42
MTP T SV A	60-540-22	60-540-52
MTP T SV A RCA	60-541-32	60-540-62
MTP T SV A AAP	70-362-02, -03	70-362-22, -23
MTP T CV	60-540-01	60-540-41
MTP T AV	60-540-21	60-540-51
MTP T AV RCA	60-540-31	60-540-61
MTP T AV AAP	70-361-02, -03	70-361-22, -23

Receiver	Old generation (stereo audio)	New generation (mono audio)
MTP R SV	60-541-02	60-541-42
MTP R SV A	60-541-22	60-541-52
MTP R SV A RCA	60-541-32	60-541-62
MTP R CV	60-541-01	60-541-41
MTP R AV	60-541-21	60-541-51
MTP R AV RCA	60-541-31	60-541-61

Mounting Options

Tabletop use (all except AAP models)

The non-AAP MTP units come with self-adhesive rubber feet attached to the four corners of the bottom. Set the MTP on a horizontal surface.

Rack mounting (all except AAP models)

For rack mounting, use any of the rack shelves listed in the "Accessories" table in the Appendix, page A-2.

UL Guidelines

Refer to the *VersaTools MTP Series User's Manual* for Underwriters Laboratories (UL) guidelines pertaining to the installation of electronic equipment into a rack.

Rack mounting instructions

Refer to the installation manual for the specific rack mount kit.

Furniture or projector mounting (except AAP models)

Use the optional mounting kit (furniture, part #70-212-01, or projector, part #70-217-01) to mount the MTP. Refer to the installation manual of the kit for detailed instructions.

Frame mounting (AAP models)

The AAP-mountable transmitters (MTP T SVA AAP and MTP T AV AAP) can be mounted to any Extron AAP mounting frame that accepts a double space (double height) AAP module. See "AAP accessories" in the appendix for a partial list of AAP devices.

NOTE *The rear panel MTP connections will be inaccessible after installation. Make all connections (see "Transmitter/ receiver throughput connections", page 1-7) and test the twisted pair system (apply a video source and observe that transmitted video is displayed satisfactorily) before installing the panel-mounted transmitter.*

Panel Features and Connections

Transmitter input connections

Figure 1-1 shows the video and audio input connectors of the MTP Series transmitters.

NOTE Some transmitters do not have audio connections.

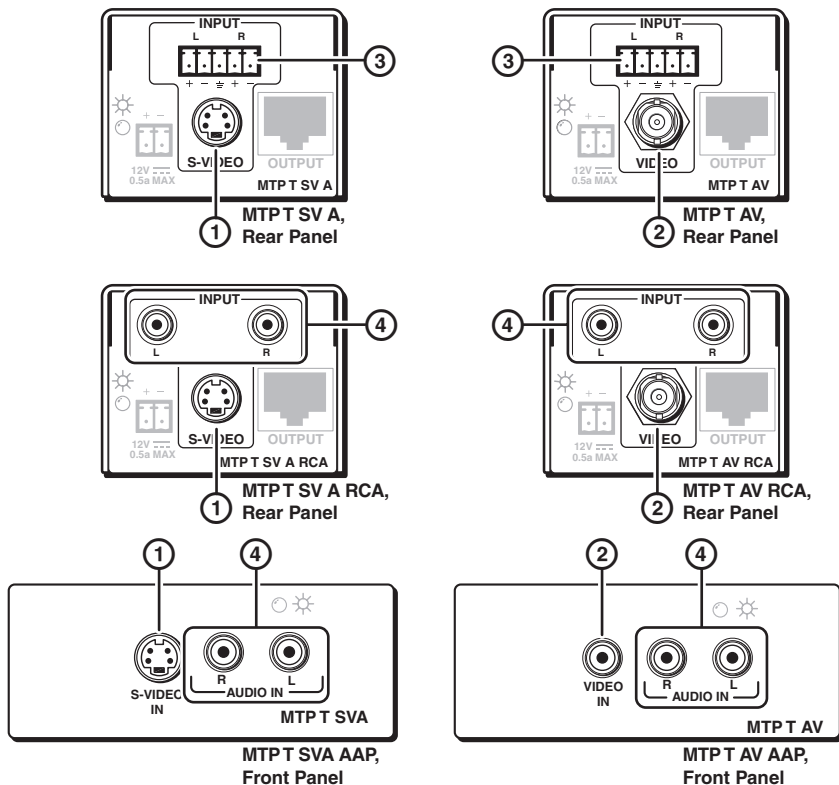

Figure 1-1 — Video and audio input connections

- ① **S-video connector (SV models)** — Connect an S-video input to this 4-pin mini DIN connector.
- ② **Composite video connector (CV and AV models)** — Connect a composite video input to this connector (female RCA on the MTP T AV AAP, female BNC on all other models).

Installation, cont'd

- ③ **Audio input captive screw connector (MTP T SV A, MTP T AV)** — Connect a balanced or unbalanced audio input to this 3.5 mm, 5-pole captive screw connector. Connectors are included with each MTP. See Figure 1-2 to wire a connector for the appropriate input type. Use the supplied tie-wrap to strap the audio cable to the extended tail of the connector. High impedance is generally over 800 ohms.

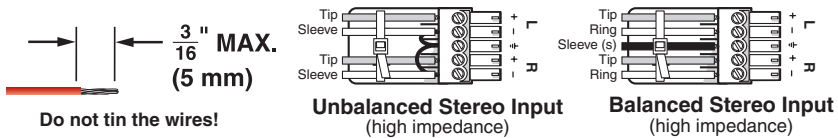

Figure 1-2 — Captive screw input connector wiring

CAUTION The length of exposed wires is critical. Ideal length is $3/16$ " (5 mm). If the stripped section of wire is longer than $3/16$ ", the exposed wires may touch, causing a short circuit. If the stripped section of wire is shorter, wires can easily be pulled out even if tightly fastened by the captive screws.

NOTE When making connections from existing audio cables see Figure 1-3. A mono audio connector consists of the tip and sleeve. A stereo audio connector consists of the tip, ring, and sleeve.

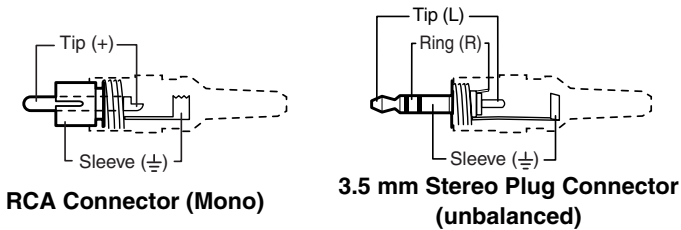

Figure 1-3 — Typical audio connectors

- ④ **Audio input RCA connectors (RCA and AAP models)** — Connect an unbalanced stereo audio source to these L(ef) and R(ight) RCA connectors (Figure 1-4).

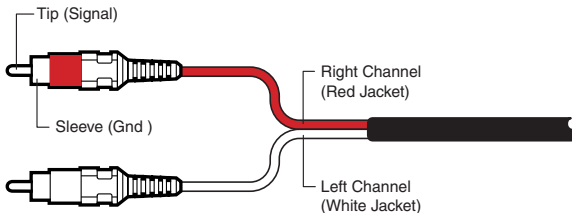

Figure 1-4 — RCA audio connectors

Transmitter/receiver throughput connections

See Figure 1-5 to identify the connections between the transmitter and receiver.

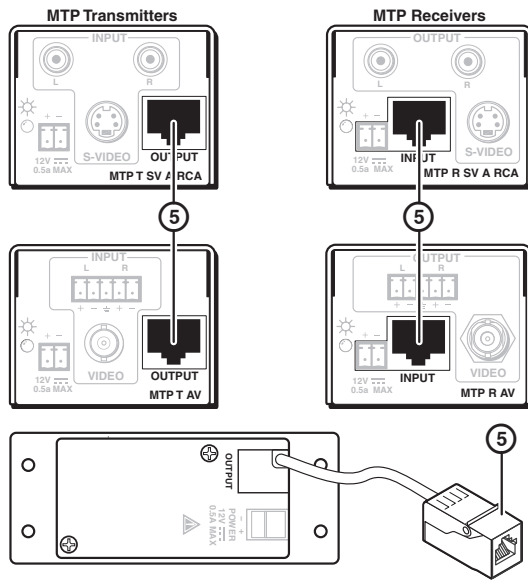

Figure 1-5 — Throughput connections

CAUTION Do not connect these devices to a computer data or telecommunications network.

NOTE RJ-45 termination must comply with the TIA/EIA T 568A or TIA/EIA T 568B wiring standards for all connections.

- ⑤ **Transmitter output and receiver input connector** — Connect one end of a TP cable to this RJ-45 female connector on the transmitter. Connect the free end of the same TP cable from the transmitter to the RJ-45 female connector on the receiver.

Twisted Pair cable termination

Terminate TP cables with RJ-45 connectors in accordance with the TIA/EIA T 568A or TIA/EIA T 568B wiring standards. Use either standard, but ensure the same is used on both cable ends.

When using Enhanced Skew-Free™ A/V cable, use **only** the TIA/EIA T 568A standard.

NOTE Enhanced Skew-free A/V cable is specially designed for compatibility with Extron Twisted Pair products using the TIA/EIA 568 A standard. It is **not recommended** for Ethernet/LAN applications.

Installation, cont'd

Power connection (all models)

See Figure 1-6 to identify the power connections and indicators.

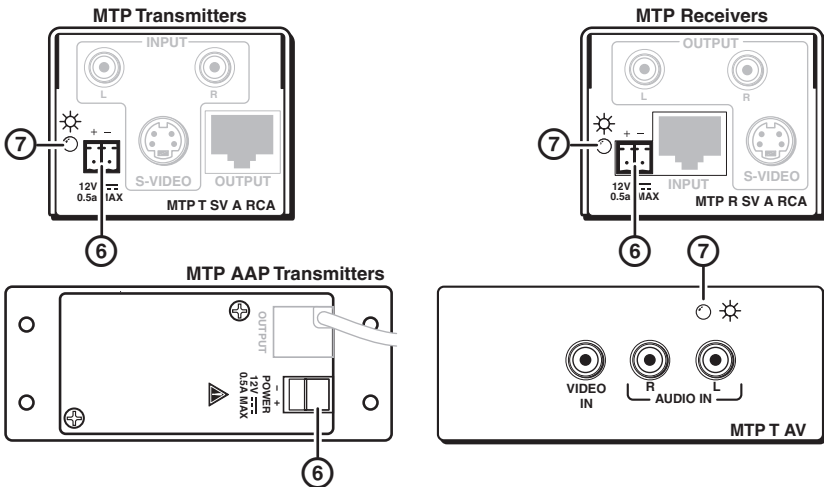

Figure 1-6 — Power connections and indicators

- ⑥ **Power connector** — Plug the external 12 VDC power supply into this 2-pole captive screw connector on both the transmitter and the receiver. Figure 1-7 shows how to wire the connectors.

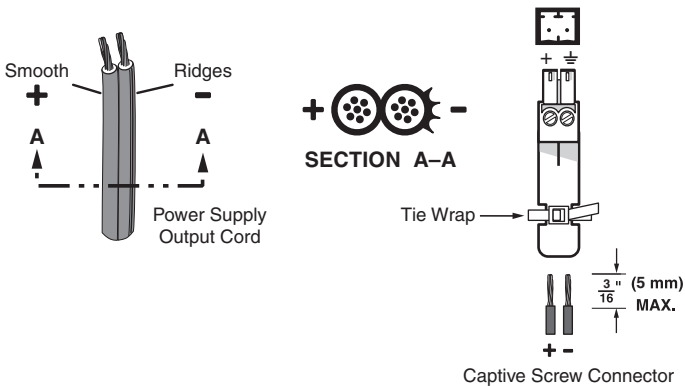

Figure 1-7 — Power connector wiring

CAUTION Power supply voltage polarity is critical. Incorrect voltage polarity can damage the power supply or MTP. Identify the power cord negative lead by the ridges on the side of the cord (Figure 1-7).

CAUTION The length of exposed wires is critical. Ideal length is 3/16" (5 mm). If the stripped section of wire is longer than 3/16" the exposed wires may touch, causing a short circuit. If the stripped section of wire is shorter, wires can easily be pulled out even if tightly fastened by the captive screws.

NOTE Do not tin the stripped leads! Tinned wires are not as secure in the captive screw and direct insertion connectors and could be pulled out.

Verify the polarity before connection! Plug in the power supply in with no load and check the output with a voltmeter.

WARNING The two power cord wires must be kept separate while the power supply is plugged in. Remove power before wiring.

Use the supplied tie-wrap to strap the power cord to the extended tail of the connector.

NOTE The transmitter/receiver pair may have shipped with a blue captive screw connector. This connector does not include the extended tail or tie-wrap but can be plugged into either a blue or an orange power receptacle.

Transmitter/receiver combinations containing new generation, non-jumpered (mono audio) units cannot be powered from a single supply. The following table shows the combination of old and new generation MTP units (jumper configured to the stereo audio position) capable of remote powering (See "Signal Jumpers for Generational Compatibility" on page 1-3).

Single Power Supply (remote powering)	
Transmitter	Receiver
Old Generation	Old Generation
Old Generation	New Generation, Jumpered*
New Generation, Jumpered*	Old Generation
New Generation, Jumpered*	New Generation, Jumpered*

*Configured for stereo audio

NOTE When configured for stereo audio, a single power supply connected to either the transmitter or receiver can power both units if there is less than 500 feet (150 meters) of STP/UTP/FTP cable between the two. If the transmitter and receiver are separated by greater than 500 feet, connect a power supply to both units regardless of the model and jumper configuration.

⑦ **Power LED** — Indicates power is applied to the MTP.

Installation, cont'd

Receiver output connections

Figure 1-8 shows all combinations of rear panel output connections for the MTP receivers.

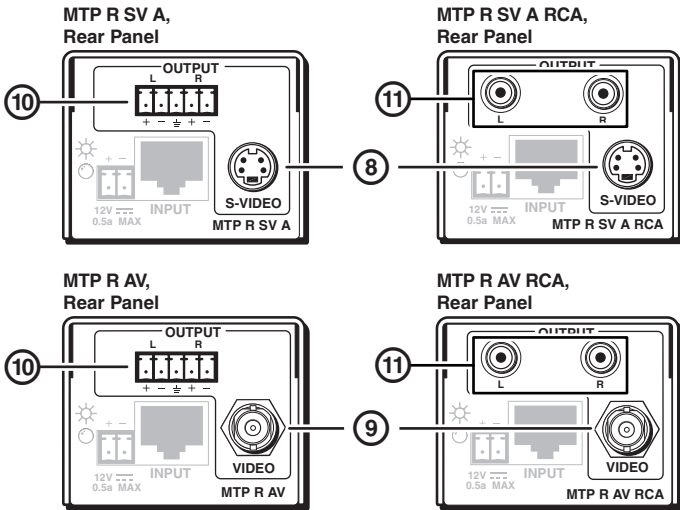

Figure 1-8 — Output connector wiring

- ⑧ S-video connector (SV models) — Connect an S-video device to this 4-pin mini DIN connector.
- ⑨ Composite video connector (CV and AV models) — Connect a composite video device to this BNC connector.
- ⑩ Captive screw audio connector (MTP R SV A, MTP R AV) — Connect a balanced or unbalanced audio device, such as an audio amplifier, to this 3.5 mm, 5-pole captive screw connector. See Figure 1-9 to properly wire the output connector.

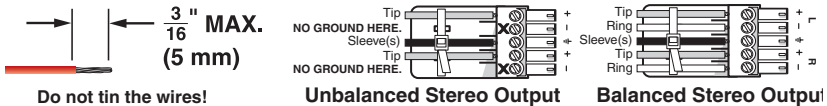

Figure 1-9 — Audio Output connector wiring

CAUTION Connect the sleeve to ground (\oplus). Connecting the sleeve to a negative (-) terminal will damage the audio output circuits.

- ⑪ RCA audio connectors (RCA models) — Connect a stereo audio device to these L(left) and R(ight) RCA connectors.



VersaTools® MTP Series Series

2

Chapter Two

Operation

Front Panel Features

Troubleshooting — Skew Delay Compensation

Front Panel Operation

Front Panel Features

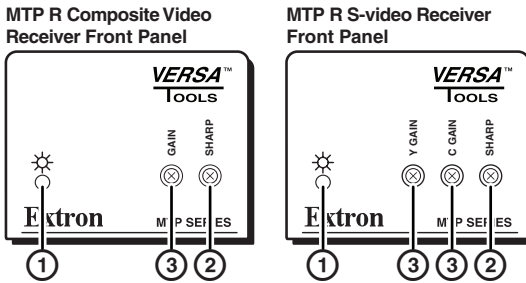

Figure 2-1 — MTP receiver front panels

- ① **Power LED** — When lit, this LED indicates power is applied to the MTP.
- ② **Sharpness** — Adjusts output image sharpness to compensate for long cable runs.
- ③ **Gain control** — Adjusts the brightness of the output image to compensate for long cable runs.

S-video receivers — There are separate controls for luminance (Y) and chrominance (C) on S-video MTP receivers. If the chrominance setting on the MTP receiver's S-video output is too low, the image may appear in monochrome. Adjust S-video gain until color appears.

Composite video receivers — There is only one gain control on composite video MTP receivers.

NOTE *All control knobs are removable to prevent unauthorized access to the adjustments.*

Troubleshooting — Skew Delay Compensation

CAT 5 TP cable can cause registration errors (luminance leads or lags chrominance) between the Y and C video signals on S-video transmitter/receiver pairs. Try using the following methods to minimize or eliminate pair skew:

- Switch to Extron Enhanced Skew-Free A/V UTP cable.
- Install an S-video-to-BNC adapter and an SEQ 100 BNC Skew Equalizer on the receiver video output. Adjust the skew for the leading video image.



VersaTools® MTP Series Series

A

Appendix A

Reference Information

Specifications

Part Numbers

Specifications, Part Numbers, and Accessories

Specifications

Consult the VersaTools User's Manual on the included CD ROM or at www.extron.com for a complete list of specifications.

Please consult the *VersaTools User's Manual* found at www.extron.com or on the included CD ROM for a complete list of optional accessories, pre-cut cables, connectors and bulk cable.

For highest quality, reliability and compatibility always use Extron cable, connectors, and bulk cable.

Extron provides adapters for most common configurations required to connect audio, video and display devices to the BNC, VGA, DVI and Audio captive connectors of the VersaTools products. Adapters for a specific installation may be found in the current Extron Product Catalog or at www.extron.com.

Part Numbers

Accessories

Accessory		Part number
PS 123	Universal 12 VDC, 3.0 Amp multiple output Power Supply	60-814-01
RSU 129	1U 9.5" Deep Universal Rack Shelf Kit	60-190-01
RSB 129	1U 9.5" Deep Basic Rack Shelf	60-604-01
RSU 126	1U 6" deep Universal Rack Shelf Kit	60-190-10
RSB 126	1U 6" Deep Basic Rack Shelf	60-604-10
RSF 123	VersaTools 1U 3.5" Deep Rack Shelf Kit	60-190-20
RSB 123	VersaTools 1U 3.5" Deep Basic Rack Shelf	60-604-20
MBU 123	VersaTools Mini Under-Desk Mount Kit	70-212-01
PMK 100	VersaTools 1/4 Rack Width Pole Mount Kit	70-217-01

MTP transmitters

Description	Part number
MTP T SV	60-540-42
MTP T SV A	60-540-52
MTP T SV A RCA	60-540-62
MTP T SV A AAP (black, white)	70-362-22, 23
MTP T CV	60-540-41
MTP T AV	60-540-51
MTP T AV RCA	60-540-61
MTP T AV AAP (black, white)	70-361-22, 23

MTP receivers

Description	Part number
MTP R SV	60-541-42
MTP R SV A	60-541-52
MTP R SV A RCA	60-541-62
MTP R CV	60-541-41
MTP R AV	60-541-51
MTP R AV RCA	60-541-61

AAP accessories

Accessory	Part number
AAP 102 panel (gray, black, white)	60-300-01, 02, 03
AAP 104 panel (black, white)	60-301-02, 03
AAP 106 panel (gray, black, white)	60-531-01, 02, 03
AAP 201 panel - half rack width, 1U (gray, black, white)	60-302-01, 02, 03
AAP 202 panel - half rack width, 2U (black, white)	60-303-02, 03
AAP 301 panel - full rack width, 1U (black, white)	60-632-02, 03
AAP 302 panel - full rack width, 2U (gray, black white)	60-633-01, 02, 03

Specifications, Part Numbers, Accessories, cont'd

Cables/connectors

NOTE *Enhanced Skew-Free™ A/V UTP cables are not recommended for Ethernet/LAN applications.*

Enhanced Skew-Free™ A/V cable	Part number
Enhanced Skew-Free A/V UTP Cable (various lengths)	26-569-xx
Enhanced Skew-Free A/V UTP, 1000' bulk	22-141-03
Plenum Enhanced Skew-Free A/V UTP, 1000' bulk	22-142-03

RJ-45 connector	Part number
CAT 6 jack (black)	100-476-01
CAT 6 jack (red)	100-477-01
CAT 6 jack (blue)	100-478-01
CAT 6 jack (orange)	100-479-01
CAT 6 jack (gray)	100-480-01
CAT 6 jack (white)	100-481-01
CAT 6 jack (ivory)	100-482-01

S-video to BNC adapter	
S-video male to 2 female BNC (8"/0.2 m)	26-353-01
S-video male to 2 male BNC (1'/0.3 m)	26-353-02

Skew compensation solutions

Skew equalizer	
SEQ 100 15HD	60-676-01

Extron's Warranty

Extron Electronics warrants this product against defects in materials and workmanship for a period of three years from the date of purchase. In the event of malfunction during the warranty period attributable directly to faulty workmanship and/or materials, Extron Electronics will, at its option, repair or replace said products or components, to whatever extent it shall deem necessary to restore said product to proper operating condition, provided that it is returned within the warranty period, with proof of purchase and description of malfunction to:

**USA, Canada, South America,
and Central America:**

Extron Electronics
1001 East Ball Road
Anaheim, CA 92805, USA

Asia:

Extron Electronics, Asia
135 Joo Seng Road, #04-01
PM Industrial Bldg.
Singapore 368363

**Europe, Africa, and the Middle
East:**

Extron Electronics, Europe
Beeldschermweg 6C
3821 AH Amersfoort
The Netherlands

Japan:

Extron Electronics, Japan
Kyodo Building,
16 Ichibancho
Chiyoda-ku, Tokyo 102-0082
Japan

This Limited Warranty does not apply if the fault has been caused by misuse, improper handling care, electrical or mechanical abuse, abnormal operating conditions or non-Extron authorized modification to the product.

If it has been determined that the product is defective, please call Extron and ask for an Applications Engineer at (714) 491-1500 (USA), 31.33.453.4040 (Europe), 65.6383.4400 (Asia), or 81.3.3511.7655 (Japan) to receive an RA# (Return Authorization number). This will begin the repair process as quickly as possible.

Units must be returned insured, with shipping charges prepaid. If not insured, you assume the risk of loss or damage during shipment. Returned units must include the serial number and a description of the problem, as well as the name of the person to contact in case there are any questions.

Extron Electronics makes no further warranties either expressed or implied with respect to the product and its quality, performance, merchantability, or fitness for any particular use. In no event will Extron Electronics be liable for direct, indirect, or consequential damages resulting from any defect in this product even if Extron Electronics has been advised of such damage.

Please note that laws vary from state to state and country to country, and that some provisions of this warranty may not apply to you.

Extron USA - West Headquarters +800.633.9876 Inside USA / Canada Only +1.714.491.1500 +1.714.491.1517 FAX	Extron USA - East +800.633.9876 Inside USA / Canada Only +1.919.863.1794 +1.919.863.1797 FAX	Extron EMEA +800.3987.6673 Inside Europe Only +31.33.453.4040 +31.33.453.4050 FAX	Extron Asia +800.7339.8766 Inside Asia Only +65.6383.4400 +65.6383.4664 FAX	Extron Japan +81.3.3511.7655 +81.3.3511.7656 FAX	Extron China +400.883.1568 Inside China Only +86.21.3760.1568 +86.21.3760.1566 FAX	Extron Middle East +971.4.2991800 +971.4.2991880 FAX
---	---	--	--	---	---	---

Free Manuals Download Website

<http://myh66.com>

<http://usermanuals.us>

<http://www.somanuals.com>

<http://www.4manuals.cc>

<http://www.manual-lib.com>

<http://www.404manual.com>

<http://www.luxmanual.com>

<http://aubethermostatmanual.com>

Golf course search by state

<http://golfingnear.com>

Email search by domain

<http://emailbydomain.com>

Auto manuals search

<http://auto.somanuals.com>

TV manuals search

<http://tv.somanuals.com>