

User's Manual



RGB 160 and RGB 164xi
Universal Interfaces

Precautions

Safety Instructions • English



This symbol is intended to alert the user of important operating and maintenance (servicing) instructions in the literature provided with the equipment.



This symbol is intended to alert the user of the presence of uninsulated dangerous voltage within the product's enclosure that may present a risk of electric shock.

Caution

Read Instructions • Read and understand all safety and operating instructions before using the equipment.

Retain Instructions • The safety instructions should be kept for future reference.

Follow Warnings • Follow all warnings and instructions marked on the equipment or in the user information.

Avoid Attachments • Do not use tools or attachments that are not recommended by the equipment manufacturer because they may be hazardous.

Consignes de Sécurité • Français



Ce symbole sert à avertir l'utilisateur que la documentation fournie avec le matériel contient des instructions importantes concernant l'exploitation et la maintenance (réparation).



Ce symbole sert à avertir l'utilisateur de la présence dans le boîtier de l'appareil de tensions dangereuses non isolées posant des risques d'électrocution.

Attention

Lire les instructions • Prendre connaissance de toutes les consignes de sécurité et d'exploitation avant d'utiliser le matériel.

Conservier les instructions • Ranger les consignes de sécurité afin de pouvoir les consulter à l'évent.

Respecter les avertissements • Observer tous les avertissements et consignes marqués sur le matériel ou présentés dans la documentation utilisateur.

Éviter les pièces de fixation • Ne pas utiliser de pièces de fixation ni d'outils non recommandés par le fabricant du matériel car cela risquerait de poser certains dangers.

Sicherheitsanleitungen • Deutsch



Dieses Symbol soll dem Benutzer in der im Lieferumfang enthaltenen Dokumentation besonders wichtige Hinweise zur Bedienung und Wartung (Instandhaltung) geben.



Dieses Symbol soll den Benutzer darauf aufmerksam machen, daß im Inneren des Gehäuses dieses Produktes gefährliche Spannungen, die nicht isoliert sind und die einen elektrischen Schock verursachen können, herrschen.

Achtung

Lesen der Anleitungen • Bevor Sie das Gerät zum ersten Mal verwenden, sollten Sie alle Sicherheits- und Bedienungsanleitungen genau durchlesen und verstehen.

Aufbewahren der Anleitungen • Die Hinweise zur elektrischen Sicherheit des Produktes sollten Sie aufbewahren, damit Sie im Bedarfsfall darauf zurückgreifen können.

Befolgen der Warnhinweise • Befolgen Sie alle Warnhinweise und Anleitungen auf dem Gerät oder in der Benutzerdokumentation.

Keine Zusatzgeräte • Verwenden Sie keine Werkzeuge oder Zusatzgeräte, die nicht ausdrücklich vom Hersteller empfohlen wurden, da diese eine Gefahrenquelle darstellen können.

Instrucciones de seguridad • Español



Este símbolo se utiliza para advertir al usuario sobre instrucciones importantes de operación y mantenimiento (o cambio de partes) que se desean destacar en el contenido de la documentación suministrada con los equipos.



Este símbolo se utiliza para advertir al usuario sobre la presencia de elementos con voltaje peligroso sin protección aislante, que puedan encontrarse dentro de la caja o alojamiento del producto, y que puedan representar riesgo de electrocución.

Precaucion

Leer las instrucciones • Leer y analizar todas las instrucciones de operación y seguridad, antes de usar el equipo.

Conservar las instrucciones • Conservar las instrucciones de seguridad para futura consulta.

Obedecer las advertencias • Todas las advertencias e instrucciones marcadas en el equipo o en la documentación del usuario, deben ser obedecidas.

Evitar el uso de accesorios • No usar herramientas o accesorios que no sean específicamente recomendados por el fabricante, ya que podrían implicar riesgos.

Warning

Power sources • This equipment should be operated only from the power source indicated on the product. This equipment is intended to be used with a main power system with a grounded (neutral) conductor. The third (grounding) pin is a safety feature, do not attempt to bypass or disable it.

Power disconnection • To remove power from the equipment safely, remove all power cords from the rear of the equipment, or the desktop power module (if detachable), or from the power source receptacle (wall plug).

Power cord protection • Power cords should be routed so that they are not likely to be stepped on or pinched by items placed upon or against them.

Servicing • Refer all servicing to qualified service personnel. There are no user-serviceable parts inside. To prevent the risk of shock, do not attempt to service this equipment yourself because opening or removing covers may expose you to dangerous voltage or other hazards.

Slots and openings • If the equipment has slots or holes in the enclosure, these are provided to prevent overheating of sensitive components inside. These openings must never be blocked by other objects.

Lithium battery • There is a danger of explosion if battery is incorrectly replaced. Replace it only with the same or equivalent type recommended by the manufacturer. Dispose of used batteries according to the manufacturer's instructions.

Avertissement

Alimentations • Ne faire fonctionner ce matériel qu'avec la source d'alimentation indiquée sur l'appareil. Ce matériel doit être utilisé avec une alimentation principale comportant un fil de terre (neutre). Le troisième contact (de mise à la terre) constitue un dispositif de sécurité : n'essayez pas de la contourner ni de la désactiver.

Déconnexion de l'alimentation • Pour mettre le matériel hors tension sans danger, déconnectez tous les cordons d'alimentation de l'arrière de l'appareil ou du module d'alimentation de bureau (s'il est amovible) ou encore de la prise secteur.

Protection du cordon d'alimentation • Acheminer les cordons d'alimentation de manière à ce que personne ne risque de marcher dessus et à ce qu'ils ne soient pas écrasés ou pincés par des objets.

Réparation-maintenance • Faire exécuter toutes les interventions de réparation-maintenance par un technicien qualifié. Aucun des éléments internes ne peut être réparé par l'utilisateur. Afin d'éviter tout danger d'électrocution, l'utilisateur ne doit pas essayer de procéder lui-même à ces opérations car l'ouverture ou le retrait des couvercles risquent de l'exposer à de hautes tensions et autres dangers.

Fentes et orifices • Si le boîtier de l'appareil comporte des fentes ou des orifices, ceux-ci servent à empêcher les composants internes sensibles de surchauffer. Ces ouvertures ne doivent jamais être bloquées par des objets.

Lithium Batterie • Il a danger d'explosion s'il y a remplacement incorrect de la batterie. Remplacer uniquement avec une batterie du même type ou d'un type équivalent recommandé par le constructeur. Mettre au rebut les batteries usagées conformément aux instructions du fabricant.

Vorsicht

Stromquellen • Dieses Gerät sollte nur über die auf dem Produkt angegebene Stromquelle betrieben werden. Dieses Gerät wurde für eine Verwendung mit einer Hauptstromleitung mit einem geerdeten (neutralen) Leiter konzipiert. Der dritte Kontakt ist für einen Erdschluß, und stellt eine Sicherheitsfunktion dar. Diese sollte nicht umgangen oder außer Betrieb gesetzt werden.

Stromunterbrechung • Um das Gerät auf sichere Weise vom Netz zu trennen, sollten Sie alle Netzkabel aus der Rückseite des Gerätes, aus der externen Stromversorgung (falls dies möglich ist) oder aus der Wandsteckdose ziehen.

Schutz des Netzkabels • Netzkabel sollten stets so verlegt werden, daß sie nicht im Weg liegen und niemand darauf treten kann oder Objekte darauf- oder unmittelbar dagegengestellt werden können.

Wartung • Alle Wartungsmaßnahmen sollten nur von qualifiziertem Servicepersonal durchgeführt werden. Die internen Komponenten des Gerätes sind wartungsfrei. Zur Vermeidung eines elektrischen Schocks versuchen Sie in keinem Fall, dieses Gerät selbst öffnen, da beim Entfernen der Abdeckungen die Gefahr eines elektrischen Schlags und/ oder andere Gefahren bestehen.

Schlitze und Öffnungen • Wenn das Gerät Schlitze oder Löcher im Gehäuse aufweist, dienen diese zur Vermeidung einer Überhitzung der empfindlichen Teile im Inneren. Diese Öffnungen dürfen niemals von anderen Objekten blockiert werden.

Lithium-Batterie • Explosionsgefahr, falls die Batterie nicht richtig ersetzt wird. Ersetzen Sie verbrauchte Batterien nur durch den gleichen oder einen vergleichbaren Batterietyp, der auch vom Hersteller empfohlen wird. Entsorgen Sie verbrauchte Batterien bitte gemäß den Herstelleranweisungen.

Advertencia

Alimentación eléctrica • Este equipo debe conectarse únicamente a la fuente/tipo de alimentación eléctrica indicada en el mismo. La alimentación eléctrica de este equipo debe provenir de un sistema de distribución general con conductor neutro a tierra. La tercera pata (puesta a tierra) es una medida de seguridad, no puenterarla ni eliminarla.

Desconexión de alimentación eléctrica • Para desconectar con seguridad la acometida de alimentación eléctrica al equipo, desenchufar todos los cables de alimentación en el panel trasero del equipo, o desenchufar el módulo de alimentación (si fuera independiente), o desenchufar el cable del receptáculo de la pared.

Protección del cables de alimentación • Los cables de alimentación eléctrica se deben instalar en lugares donde no sean pisados ni apretados por objetos que se puedan apoyar sobre ellos.

Reparaciones/mantenimiento • Solicitar siempre los servicios técnicos de personal calificado. En el interior no hay partes a las que el usuario deba acceder. Para evitar riesgo de electrocución, no intentar personalmente la reparación/mantenimiento de este equipo, ya que al abrir o extraer las tapas puede quedar expuesto a voltajes peligrosos u otros riesgos.

Ranuras y aberturas • Si el equipo posee ranuras o orificios en su caja/alojamiento, es para evitar el sobrecalentamiento de componentes internos sensibles. Estas aberturas nunca se deben obstruir con otros objetos.

Batería de litio • Existe riesgo de explosión si esta batería se coloca en la posición incorrecta. Cambiar esta batería únicamente con el mismo tipo (o su equivalente) recomendado por el fabricante. Desachar las baterías usadas siguiendo las instrucciones del fabricante.

安全须知 • 中文



这个符号提示用户该设备用户手册中有重要的操作和维护说明。



这个符号警告用户该设备机壳内有露的危险电压，有触电危险。

注意

阅读说明书 • 用户使用该设备前必须阅读并理解所有安全和使用说明。

保存说明书 • 用户应保存安全说明书以备将来使用。

遵守警告 • 用户应遵守产品和用户指南上的所有安全 and 操作说明。

避免追加 • 不要使用该产品厂商没有推荐的工具或追加设备，以避免危险。

FCC Class A Notice

This equipment has been tested and found to comply with the limits for a Class A digital device, pursuant to part 15 of the FCC Rules. Operation is subject to the following two conditions: (1) this device may not cause harmful interference, and (2) this device must accept any interference received, including interference that may cause undesired operation. The Class A limits are designed to provide reasonable protection against harmful interference when the equipment is operated in a commercial environment. This equipment generates, uses, and can radiate radio frequency energy and, if not installed and used in accordance with the instruction manual, may cause harmful interference to radio communications. Operation of this equipment in a residential area is likely to cause harmful interference, in which case the user will be required to correct the interference at his own expense.

NOTE

This unit was tested with shielded cables on the peripheral devices. Shielded cables must be used with the unit to ensure compliance with FCC emissions limits.

This page is intentionally left blank

Table of Contents

Chapter 1 • Introduction	1-1
About this Manual	1-2
About the Interfaces	1-2
Features	1-2
Chapter 2 • Controls and Installation	2-1
Front Panel Features	2-2
Rear Panel Features	2-3
Installation	2-4
Installation overview.....	2-4
Mounting the interface	2-5
Rack mounting (RGB 164 _{xi} only)	2-5
Under desk mounting	2-6
Through desk mounting	2-7
Cabling	2-8
Setting the DIP switches	2-10
Rear panel switches	2-10
Front panel switches	2-11
Setting internal jumpers.....	2-12
Appendix A • Reference Information	A-1
Specifications	A-2
Accessories and Part Numbers	A-5
Mounting Templates	A-7

All trademarks mentioned in this manual are the properties of their respective owners.



This page is intentionally left blank

1 Chapter One

Introduction

About this Manual

About the Interfaces

Features

Introduction

About this Manual

This manual documents two universal interfaces: RGB 160xi and RGB 164xi. Unless otherwise specified, any references to “the interface” refers to the features or operation of both interfaces.

About the Interfaces

The RGB 160xi and 164xi are universal interfaces with a video bandwidth of 300 MHz and a horizontal frequency range of 15-160 kHz.

Features

- 2-color power/signal LED** — When the interface is on, the power/signal LED lights amber. When the interface is on and a signal is present, the LED lights green.
- Gain/peak control**— Increases signal voltages to compensate for signal degradation caused by long cable lengths.
- Stereo audio** — Front panel audio input and a 3.5 mm captive screw output connector on the rear panel.
- Horizontal shift** — The picture can be shifted horizontally. A min/max LED indicator lights red whenever the shifting reaches its lower or upper limits.
- ADSP™ (Advanced Digital Sync Processing)** — Allows sync processing operations, such as horizontal centering, to occur without affecting the signal’s sync timing. This allows horizontal centering to be applied to signals that are output to digital display devices, such as LCD projectors, DLP (digital light processor) projectors, and plasma displays.
- Dual outputs (RGB 164xi only)** — Provides two identical interfaced outputs.
- Buffered local monitor outputs** — Provides a buffered local monitor output.
- Under/through desk mounting** — The interfaces can be mounted either under or through a desk, or other suitable surface, using the optional mounting kit.
- Rack mounting (RGB 164xi only)** — The RGB 164xi can be mounted on a standard 1U Universal rack shelf.



RGB 160xi and RGB 164xi

Chapter Two

Controls and Installation

Front Panel Features

Rear Panel Features

Installation

Front Panel Features

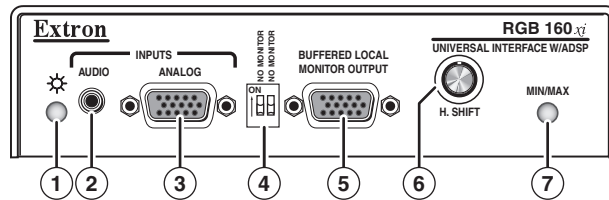

Figure 2-1 — RGB 160xi front panel

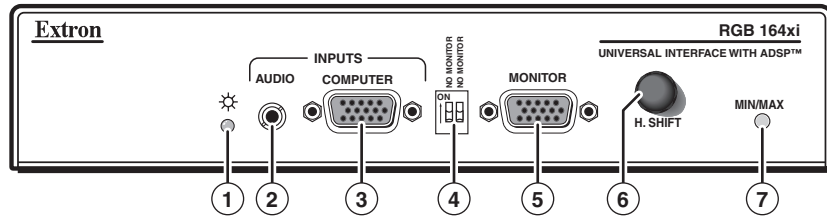

Figure 2-2 — RGB 164xi front panel

- ① **2-color power/signal LED** — Lights amber to indicate power on only; lights green to indicate power on with video signal present.
 - ② **Audio input jack** — 3.5 mm stereo input.
 - ③ **Analog input connector** — 15-pin HD female analog video input connector.
 - ④ **ID bit termination DIP switches** — Provides proper ID bit termination on the local monitor output for a laptop computer that is not attached to a local monitor port.
 - ⑤ **Buffered local monitor output (RGB 160xi and RGB 164xi only)** — 15-pin HD female for output to a local monitor.
 - ⑥ **Horizontal shift control knob** — Adjusts horizontal shifting of the remote output display device.
- NOTE** DDSP disables horizontal shift.
- ⑦ **Min/max LED** — Lights red whenever the lower or upper limits of the horizontal shift control is reached.

Rear Panel Features

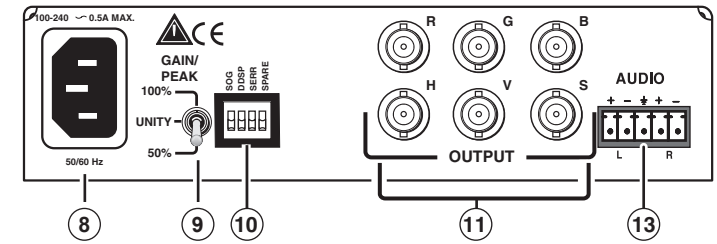

Figure 2-3 — RGB 160xi rear panel

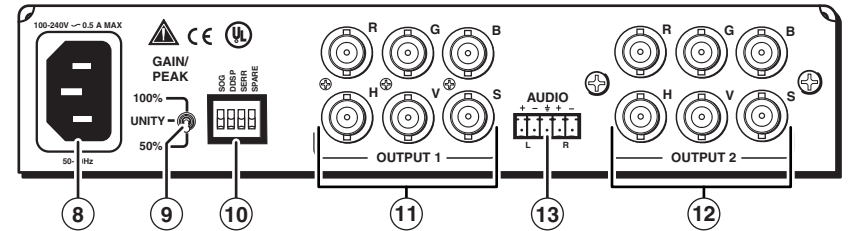

Figure 2-4 — RGB 164xi rear panel

- ⑧ **AC power input** — Standard IEC AC power connector (100 - 240 VAC, 50/60 Hz).
- ⑨ **3-position gain/peak switch** — Unity; gain with 50% peaking; and gain with 100% peaking. Unity sets the output level equivalent to the input, with no added peaking.

NOTE If the cable between the interface and the display device is shorter than 125 feet, and the Gain/Peak switch is set to a value other than Unity, image overcompensation can occur. If the edges of the image seem to exceed their boundaries, or if thin lines and sharp edges look thick and fuzzy, adjust the Gain/Peak switch setting.

- ⑩ **DIP switches** — 4 switches to control sync on green on output, Digital Display Sync Processing, and serration pulses. The fourth DIP switch is a spare (see "Setting the DIP switches" in this chapter).

NOTE DDSP disables horizontal shift.

- ⑪ ⑫ **Output 1 and Output 2** — 6 BNC connectors each to output RGsB, RGbS, and RGBHV. There is only one output on the RGB 160xi
- ⑬ **Stereo audio output** — 3.5 mm captive screw audio connector.

Installation

Installation overview

Except where noted, the installation procedures for the various interface models are the same. See "Cabling" in this chapter for additional information.

- 1 If desired, mount the interface to an equipment rack (RGB 164xi only) or to or through a desk or other suitable surface using Extron's optional mounting kit. See "Mounting the interface" in the next section.
- 2 Turn off power to the computer and its monitor. Turn off power to the projector or display device. Disconnect the power cord from the interface.
- 3 If a local computer monitor is being used, connect the monitor to the Buffered Local Monitor Output connector.
- 4 For audio connections, see the "Cabling" section in this chapter.
- 5 Connect the projector or other output display device(s) to the interface's BNC output connectors, as described in the "Cabling" section in this chapter.
- 6 Set the interface's DIP switches. See "Setting the DIP switches" at the end of this chapter.
- 7 Power on the computer, monitor, projector/display device, and the interface. The image should now display on screen. If it does not, double check steps 2 through 7 and make adjustments as needed. To adjust horizontal sync polarity and to set vertical sync pulse width, see "Setting internal jumpers" section at the end of this chapter.

Mounting the interface

The RGB 164xi can be mounted on a rack. Both the RGB 160xi and the RGB 164xi can be mounted under or through a desk or other surface using optional mounting kits.

Rack mounting (RGB 164xi only)

If desired, mount the RGB 164xi on an optional Extron RSU 129 1U universal rack shelf kit (part #60-190-01) or RSB 129 1U basic rack shelf (part #60-604-01) and in an equipment rack (figure 2-5) as follows:

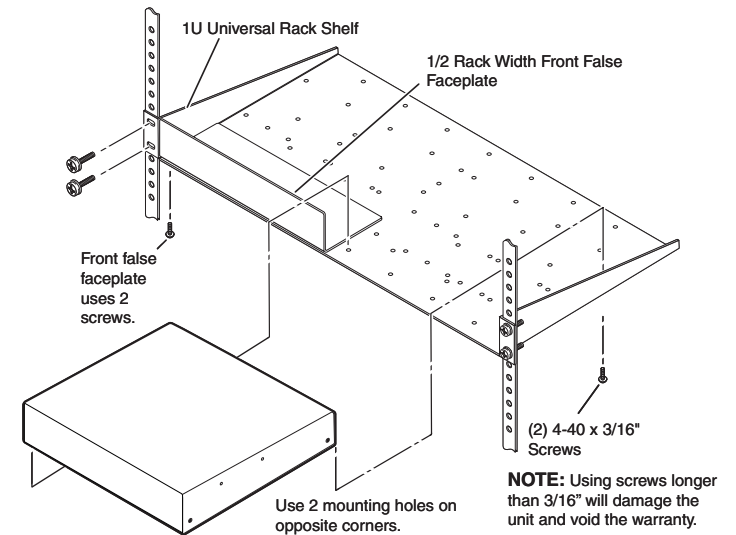

Figure 2-5 — Rack mounting the RGB 164xi

1. Remove the feet from the bottom of the case if installed.
2. Mount the converter on the rack shelf, using two 4-40 x 3/16" screws in opposite (diagonal) corners.
3. Install a blank panel (not included with the basic rack shelf) or another 1U half-rack unit on the unused side of the rack.

Under desk mounting

Mount the interface under a desk or in a podium, using an optional Extron MBU 125 Under-desk mount kit (part #70-077-01) as follows:

1. Attach the mounting brackets to the interface using four machine screws supplied with the mounting kit (figure 2-6).

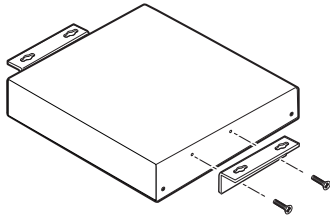

Figure 2-6 — Attaching the under desk brackets

2. Using the **not-to-scale** template at the back of this manual or the device with mounting brackets installed to guide you, mark the four screw holes on the underside of the surface to which you are mounting the interface.
3. Drill four pilot holes, each 3/32" (2 mm) in diameter by 1/4" (6 mm) deep, where marked.
4. Using the four wood screws provided, attach the brackets under the mounting surface (figure 2-7).

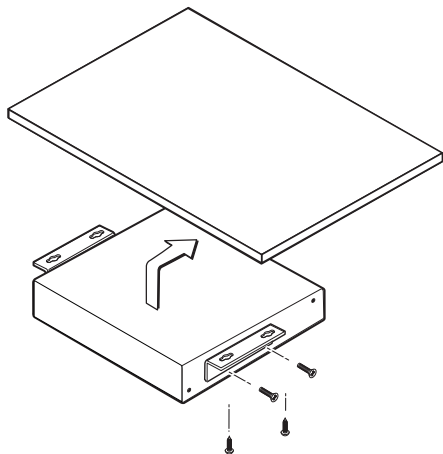

Figure 2-7 — Securing the interface to the surface

Through desk mounting

Mount the interface through a desk or table, as follows:

1. Attach the mounting brackets to the interface using four machine screws and washers (supplied with the mounting kit), as indicated in figure 2-8.

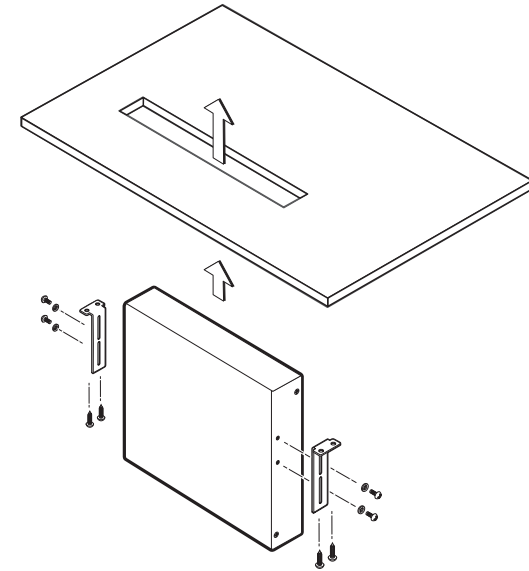

Figure 2-8 — Attaching the through desk brackets

2. Using the **not-to-scale** template at the back of this manual to guide you or the device with mounting brackets installed to guide you, mark the four screw holes on the underside of the surface to which you are mounting the interface.
3. Cut the hole.
4. Drill four pilot holes, each 3/32" (2 mm) in diameter by 1/4" (6 mm) deep, where marked.
5. Using the four wood screws provided, attach the brackets to the mounting surface.

Cabling

Figure 2-9 and figure 2-10 show how to connect the interfaces.

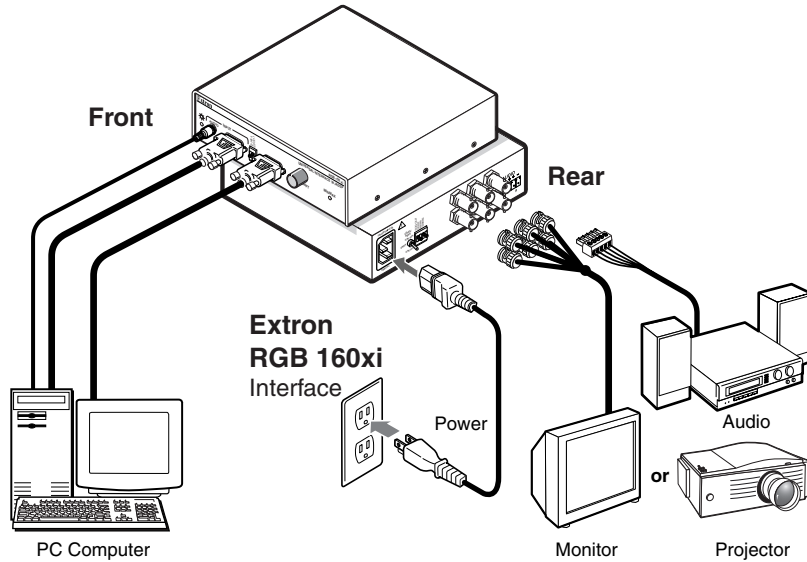

Figure 2-9 — RGB 160xi installation

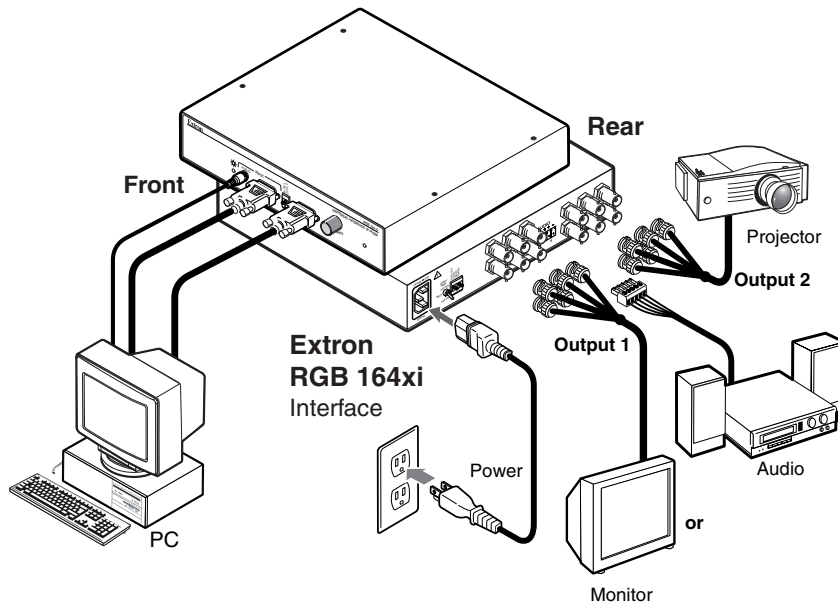

Figure 2-10 — RGB 164xi installation

Each interface can connect to the computer or workstation's local monitor and to a projector or other display device.

1. Connect the computer to the interface's "Analog" connector (RGB 160xi) or "Computer" connector (RGB 164xi).

NOTE Extron does not guarantee the performance of the interface if a low quality input cable is used.

2. Connect the unbalanced stereo audio sources (computer or other devices such as a CD player) to the front panel Audio Input jack.

Wire the audio jack as shown in figure 2-11.

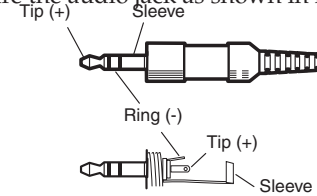

Figure 2-11 — Audio input connection wiring

3. Use cables with BNC connectors to connect the interface to a projector or other display device(s) (figure 2-12).

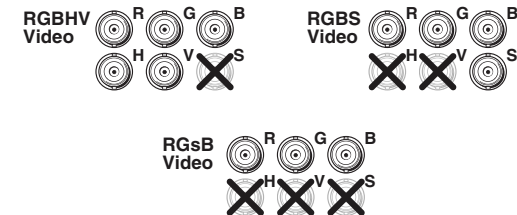

Figure 2-12 — Video output wiring pin assignments

RGBHV – If both the H & V cables are connected, the interface outputs separate horizontal and vertical sync signals.

RGBS – If the S (composite sync) cable is connected, the interface outputs composite sync.

RGSB – If coax cables are connected and terminated (75 ohms) to the red, green, and blue channels only, and the SOG OUT switch is set to on (see "Setting the DIP switches" in this chapter), the interface outputs sync on green.

- Before connecting audio, determine whether your audio system is unbalanced or balanced. Connect an audio device, such as powered speakers, to the rear panel stereo audio output connector for balanced or unbalanced audio output. Following the wiring guide (figure 2-13), insert the wires into the appropriate openings in the captive screw connector. Tighten the screws on top to fasten the wires, then insert the wired audio connector into the audio output connector on the interface rear panel.

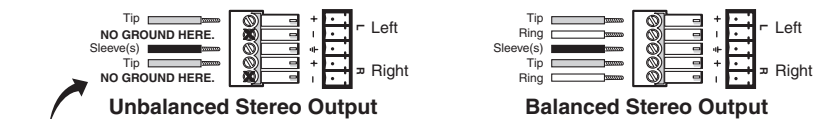

CAUTION

For unbalanced audio, connect the sleeve(s) to the center contact ground. **DO NOT** connect the sleeve(s) to the negative (-) contacts.

Figure 2-13 — Captive screw connector wiring for audio output

Setting the DIP switches

Four DIP switches on the rear panel and two DIP switches on the front panel of the interfaces configure the interface. The DIP switches control:

- Sync on green output
- Digital display sync processing
- Serration pulses
- ID bit termination

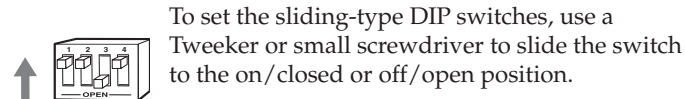

Rear panel switches

SOG (sync on green output)

- On** — If this switch is set to on (up), the interface outputs a composite sync signal on top of the green video signal via the G output connector (RGsB).
- Off** — If the SOG feature is set to off (down), output is RGBS or RGBHV, depending on how the interface and projector are cabled.



DDSP™ (digital display sync processing)

- On** — If this switch is set to on (up), the interface does not perform sync processing. This may be necessary for digital display devices, such as LCD (liquid crystal display), DLP (digital light processor) and plasma displays.
- Off** — If this switch is set to off (down), the interface performs sync processing operations, such as horizontal shift, using Extron's ADSP™.

NOTE

Turning on the DDSP feature disables the horizontal shift control.

SERR (serration pulses)

Many display devices, such as LCD and DLP projectors and plasma displays, must not have serration pulses present in the sync signal in order to display images properly. Flagging or bending at the top of the video image is a sign that the serration pulses should not be present.

- On** — When this switch is set on (up), serration pulses are present with sync signal output.
- Off** — When this switch is set off (down), serration pulses are not present with sync signal output.

Front panel switches

The RGB 160xi and RGB 164xi have two pin termination DIP switches to provide proper ID bit termination for a laptop computer that is not attached to a local monitor.

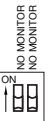

No Monitor

- On** — Set both pins to on (up) if you are using the interface with a laptop computer that is *not* connected to a local monitor.
- Off** — Set both pins to off (down) if you are connecting a local monitor to the interface.

Setting internal jumpers

The jumpers inside the interfaces are set at the factory for optimal use by most systems. However, you can change a jumper setting to meet the needs of a particular system.

WARNING Changes to internal jumper settings must be performed by authorized service personnel only.

The user-configurable, internal jumpers control the following functions:

- Horizontal and vertical sync polarity
- Vertical sync pulse width

Follow these steps to change the jumper settings. The RGB 164xi is shown for illustration, but the steps apply to both interfaces.

1. Remove power from the interface by disconnecting the AC power cord from the unit.
2. Open the cover of the interface (the top half of the enclosure) as follows:
 - a. Remove the screws from the top cover of the enclosure (figure 2-14).
 - b. Remove the three screws that are in the Output 1 BNC group.
 - c. Lift the cover straight up.

CAUTION Do not touch any switches or electronic components inside the interface. Doing so could damage the interface.

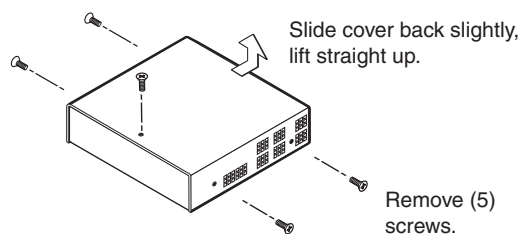

Figure 2-14 — Opening the interface cover

3. Note the positions of jumpers J20 and J40 before changing jumper settings. Figure 2-15 shows the locations of the J20 and J40 jumpers and the two possible setting combinations for 3-pin jumpers.

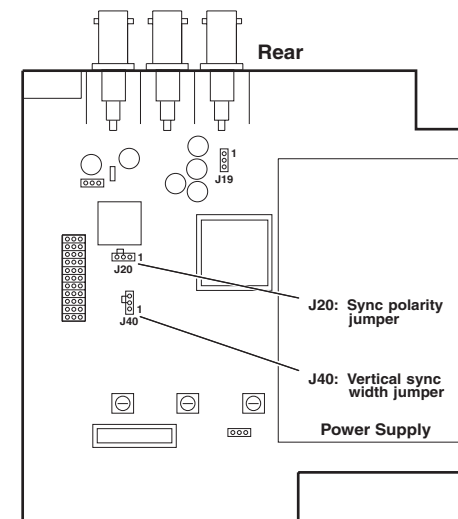
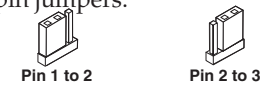

Figure 2-15 — Circuit board jumper locations

4. Configure the jumpers as defined on the next page. To configure the jumpers, use pliers to pull the jumper shunt off the pins, then place the jumper on the appropriate pins (figure 2-16).

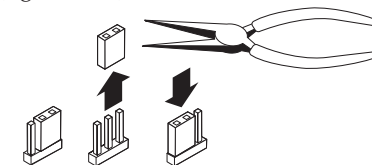
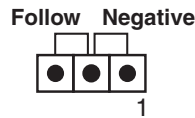

Figure 2-16 — Changing jumper settings

The jumpers perform the following functions:

J20: Sync polarity jumper — This jumper adjusts the output sync polarity. Horizontal (H) and vertical (V) sync output can either follow input sync polarity, or be forced to negative.



- If the jumper is placed on pins 1 and 2, output H and V sync polarities is forced to negative.
- If the jumper is placed on pins 2 and 3, output sync polarity follows input sync polarity; the output sync signal's polarity is the same as the input polarity. This is the default setting.

J40: Vertical sync width jumper — This jumper adjusts the vertical sync pulse width. Some digital display devices have very specific requirements for incoming sync pulse width. If no picture displays, the picture cuts in and out, or the picture is scrambled, try adjusting the vertical sync pulse width or switching from ADSP™ to DDSPT™.

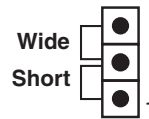

- If the jumper is placed on pins 1 and 2, the output vertical sync pulse is short (narrow).
 - If the jumper is placed on pins 2 and 3, the output vertical sync pulse is wide. This is the default setting.
5. Replace and fasten the enclosure cover, reversing step 2.



RGB 160_{xi} and RGB 164_{xi}

Appendix A

Reference Information

Specifications

Accessories and Part Numbers

Mounting Templates

Reference Information

Specifications

Video

Gain	Unity, (0.725 V _{p-p}) 50% peaking, (0.75 V _{p-p}) 100% peaking
Bandwidth	300 MHz (-3 dB)

Video input

Number/signal type.....	1 analog RGBHV, RGBS, RGSB, RsGsBs
Connectors	1 female 15-pin HD
Nominal level	0.7 V _{p-p} for RGB
Minimum/maximum levels.....	Analog: 0.3 V to 1.5 V _{p-p} with no offset at unity gain
Impedance	75 ohms
Horizontal frequency.....	Autoscan 15 kHz to 130 kHz
Vertical frequency.....	Autoscan 30 Hz to 120 Hz
Return loss	-30 dB @ 5 MHz
DC offset (max. allowable).....	4.0 V

Video output

Number/signal type	
RGB 160xi	1 analog RGBHV, RGBS, RGSB
RGB 164xi	2 analog RGBHV, RGBS, RGSB
Connectors	
RGB 160xi	6 female BNC 1 female 15-pin HD local monitor buffered output
RGB 164xi	2 x 6 female BNC 1 female 15-pin HD local monitor buffered output
Nominal level	0.7 V _{p-p} for RGB
Minimum/maximum levels	Analog: 0.7 V to 0.75 V _{p-p} with 0.70 V _{p-p} input
Impedance	75 ohms
Return loss	-30 dB @ 5 MHz

Sync

Input type	RGBHV TTL (±), RGBS TTL (±), RGSB 0.3 V (-), RsGsBs 1.3 V (-)
Output type.....	RGBHV (±), RGBS (±), RGSB (-)
Input level	2 V to 5.5 V _{p-p} with ±0.2 VDC offset (max.)
Output level	4 V to 5 V _{p-p} , unterminated

Input impedance	510 ohms
Output impedance	75 ohms
Max. propagation delay	48 ns
Max. rise/fall time	3.5 ns
Polarity.....	RGBHV: when RGBHV is input, polarity follows input; otherwise negative RGBS, RGSB: negative

Audio

Gain	Unbalanced output: 0 dB; balanced output +6 dB
Frequency response	20 Hz to 20 kHz, ±0.05 dB
THD + Noise	0.03% @ 1 kHz, 0.3% @ 20 kHz at nominal level
S/N	>72 dB, at maximum output (14 dBu), balanced (unweighted)
Stereo channel separation	>66 dB @ 1 kHz to 20 kHz

Audio input

Number/signal type	1 PC level stereo, unbalanced
Connectors	(1) 3.5 mm stereo jack, 2 channel; tip (L), ring (R), sleeve (ground)
Impedance	5k ohms, DC coupled
Nominal level	-10 dBV (316 mV _{rms})
Maximum level	+4.2 dBu, (unbalanced) at 1% THD+N

NOTE 0 dBu = 0.775 V_{rms}, 0 dBV = 1 V_{rms}, 0 dBV ≈ 2 dBu

Audio output

Number/signal type	1 stereo (2 channel), balanced/unbalanced
Connectors	(1) 3.5 mm captive screw connector, 5 pole
Impedance	50 ohms unbalanced, 100 ohms balanced
Gain error	±0.1 dB channel to channel
Maximum level (600 ohm)	>+8.8 dBm, balanced at 1% THD+N

General

Power	100 VAC to 240 VAC, 50/60 Hz, 15 watts, internal, autoswitchable
MBC power jack.....	9.0 VDC, 150 mA

Reference Information, cont'd

Temperature/humidity.....	Storage: -40 to +158 °F (-40 to +70 °C) / 10% to 90%, noncondensing Operating: +32 to +104 °F (0 to +40 °C) / 10% to 90%, noncondensing
Rack mount	
RGB 160xi	No
RGB 164xi	Yes, with optional rack shelf, #60-190-01
Furniture mount.....	Yes, with optional kits, #70-077-01 and #70-077-02
Enclosure type	Metal
Enclosure dimensions	
RGB 160xi	1.75" H x 6.4" W x 6.0" D 4.4 cm H x 16.3 cm W x 15.2 cm D (Depth excludes connectors.)
RGB 164xi	1.75" H x 8.75" W x 6.0" D (1U high, half rack wide) 4.4 cm H x 22.2 cm W x 15.2 cm D (Depth excludes connectors.)
Product weight	RGB 164xi 1.7 lbs (0.8 kg) RGB 160xi... 1.4 lbs (0.6 kg)
Shipping weight	RGB 160xi 3 lbs (2 kg) RGB 164xi 4 lbs (2 kg)
Vibration	ISTA 1A in carton (International Safe Transit Association)
Listings.....	UL
Compliances.....	CE, FCC Class A
MTBF.....	30,000 hours
Warranty	3 years parts and labor

NOTE All nominal levels are at $\pm 10\%$.

NOTE Specifications are subject to change without notice.

Accessories and Part Numbers

Universal Interfaces	Part number
RGB 160xi	60-378-01
RGB 164xi	60-485-01

Mounting Kits	Part number
RSU 129 1U 9.5" Universal Rack Shelf Kit	60-190-01
MBU 125 Under-desk mounting kit	70-077-01
MBD 129 Through-desk mounting kit	70-077-02

Signal Input Cable Kits	Part number
VGA-A M-M MD/3: Male to Male VGA cable with audio connector (3 feet/90 cm)	26-490-01
VGA M-M MD/3: Male to Male VGA cable (3 feet/90 cm)	26-238-14
VGA-A M-M MD/6: Male to Male VGA cable with audio connector (6 feet/1.8 m)	26-490-02
VGA M-M MD/6: Male to Male VGA cable (6 feet/1.8 m)	26-238-01
Mac 15-HD: 15-pin D to 15-pin HD adapter cable with Audio (6 feet/1.8 m)	70-156-01
13W3-15HD: 13W3 to 15-pin HD adapter cable with Audio (6 feet/1.8 m)	70-157-03

BNC Cables	Part number
MHR-5 BNC Series: 5 Male to Male BNC connector, Mini High Resolution Cable (3 feet/90 cm to 100 feet/30.4 m)	26-260-xx
MHR-5P BNC Series: 5 Male to Male BNC connector, Mini High Resolution Cable Plenum (3 feet/90 cm to 100 feet/30.4 m)	26-378-xx

Miscellaneous	Part number
3.5 mm captive screw connector (five pole)	10-319-10

Mounting Templates

NOTE All dimensions are in inches. Drawings not to scale.

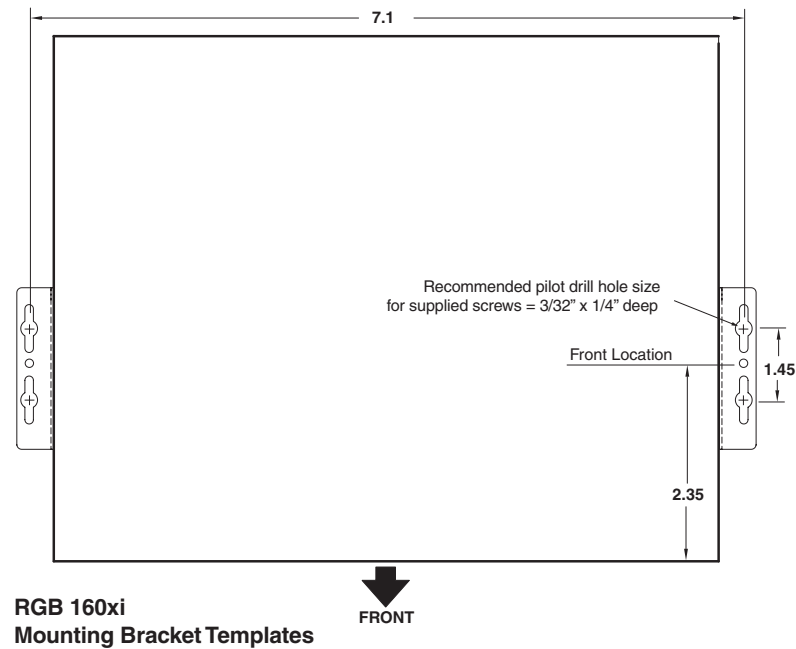
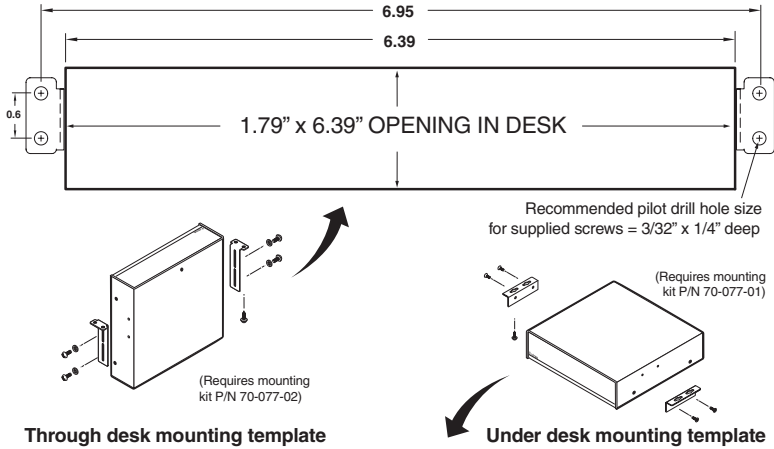

Figure A-1 — RGB160xi templates

NOTE All dimensions are in inches. Drawings not to scale.

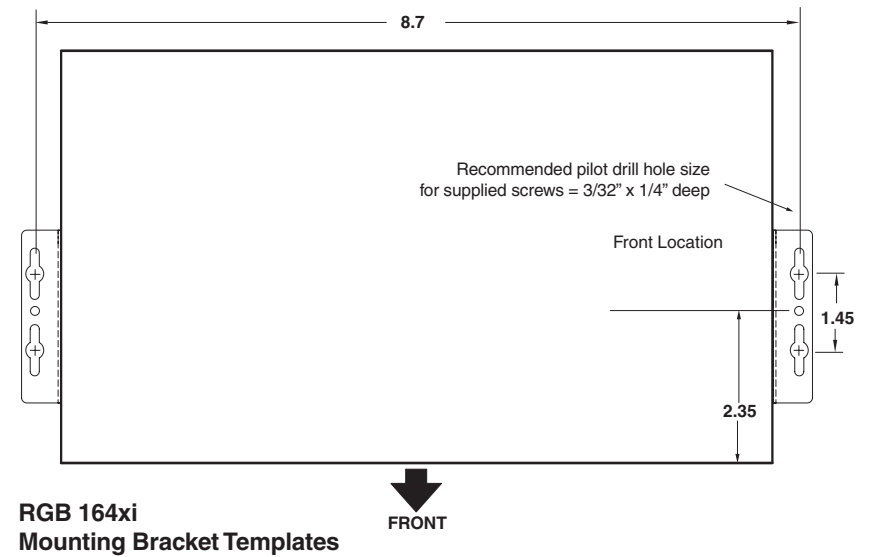
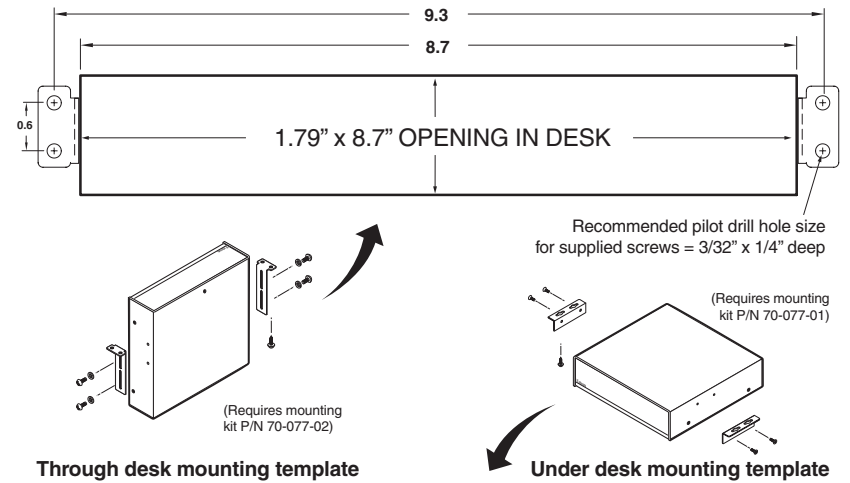

Figure A-2 — RGB164xi templates

Extron's Warranty

Extron Electronics warrants this product against defects in materials and workmanship for a period of three years from the date of purchase. In the event of malfunction during the warranty period attributable directly to faulty workmanship and/or materials, Extron Electronics will, at its option, repair or replace said products or components, to whatever extent it shall deem necessary to restore said product to proper operating condition, provided that it is returned within the warranty period, with proof of purchase and description of malfunction to:

**USA, Canada, South America,
and Central America:**

Extron Electronics
1230 South Lewis Street
Anaheim, CA 92805, USA

Asia:

Extron Electronics, Asia
135 Joo Seng Road, #04-01
PM Industrial Bldg.
Singapore 368363

Europe, Africa, and the Middle East:

Extron Electronics, Europe
Beeldschermweg 6C
3821 AH Amersfoort
The Netherlands

Japan:

Extron Electronics, Japan
Kiyodo Building,
16 Ichibancho
Chiyoda-ku, Tokyo 102-0082
Japan

This Limited Warranty does not apply if the fault has been caused by misuse, improper handling care, electrical or mechanical abuse, abnormal operating conditions or non-Extron authorized modification to the product.

If it has been determined that the product is defective, please call Extron and ask for an Applications Engineer at (714) 491-1500 (USA), 31.33.453.4040 (Europe), 65.6383.4400 (Asia), or 81.3.3511.7655 (Japan) to receive an RA# (Return Authorization number). This will begin the repair process as quickly as possible.

Units must be returned insured, with shipping charges prepaid. If not insured, you assume the risk of loss or damage during shipment. Returned units must include the serial number and a description of the problem, as well as the name of the person to contact in case there are any questions.

Extron Electronics makes no further warranties either expressed or implied with respect to the product and its quality, performance, merchantability, or fitness for any particular use. In no event will Extron Electronics be liable for direct, indirect, or consequential damages resulting from any defect in this product even if Extron Electronics has been advised of such damage.

Please note that laws vary from state to state and country to country, and that some provisions of this warranty may not apply to you.



Extron Electronics, USA
1230 South Lewis Street
Anaheim, CA 92805
800.633.9876 714.491.1500
FAX 714.491.1517

Extron Electronics, Europe
Beeldschermweg 6C
3821 AH Amersfoort, The Netherlands
+800.3987.6673 +31.33.453.4040
FAX +31.33.453.4050

Extron Electronics, Asia
135 Joo Seng Rd. #04-01
PM Industrial Bldg., Singapore 368363
+800.7339.8766 +65.6383.4400
FAX +65.6383.4664

Extron Electronics, Japan
Kyodo Building, 16 Ichibancho
Chiyoda-ku, Tokyo 102-0082
Japan
+81.3.3511.7655 FAX +81.3.3511.

Free Manuals Download Website

<http://myh66.com>

<http://usermanuals.us>

<http://www.somanuals.com>

<http://www.4manuals.cc>

<http://www.manual-lib.com>

<http://www.404manual.com>

<http://www.luxmanual.com>

<http://aubethermostatmanual.com>

Golf course search by state

<http://golfingnear.com>

Email search by domain

<http://emailbydomain.com>

Auto manuals search

<http://auto.somanuals.com>

TV manuals search

<http://tv.somanuals.com>