

## CARE & INSTRUCTIONS MANUAL GUIDE D'UTILISATION ET D'ENTRETIEN MANUAL DE INSTRUCCIONES Y MANTENIMIENTO

24" CONVECTION OVEN  
60 CM FOUR À CONVECTION  
24" HORNO DE CONVECCIÓN

5HA-196 X

5HA-200 LX  
5HA-200 RX



**NOTE:** To avoid accident and damage, please read these instructions carefully before operating the appliance.

**NOTE:** Veuillez lire ces instructions attentivement a fin d'éviter accidents et dommages.

**NOTA:** Por favor, lea este manual de instrucciones atentamente para evitar posibles daños o accidentes.

# PRODUCT WARRANTY

## **ONE-YEAR LIMITED WARRANTY**

For one year from the date of purchase, provided this product is operated and maintained in accordance with the instructions attached to or furnished with the product, Fagor America Inc. will replace parts and provide labor to correct defects in materials or workmanship. Service has to be provided by a Fagor America Inc. designated service company. Please contact Fagor America at 1 800 207 0806 or by email at [infoappliances@fagoramerica.com](mailto:infoappliances@fagoramerica.com)

## **THIS LIMITED WARRANTY DOES NOT COVER**

1. Repairs when the product is used in other than normal, single family household use.
2. Damage resulting from accident, alteration, misuse, abuse, fire, acts of God, improper installation, installation not in accordance with local electrical and plumbing codes, or use not approved by Fagor America.
3. Replacement parts or repair labor costs if the product is operated outside of the United States/Canada
4. Pick up/delivery. This product is designated to be repaired at home.

## **FAGOR AMERICA WILL NOT BE LIABLE FOR INCIDENTAL OR CONSEQUENTIAL DAMAGES**

Some states do not allow the exclusion or limitation of incidental or consequential damages so this exclusion or limitation may not apply to you. This warranty gives you specific legal rights and you may also have other rights which vary from state to state.

## **IF YOU NEED SERVICE**

Please contact Customer Care at Fagor America at 1.800.207.0806 or email Fagor America at [infoappliances@fagoramerica.com](mailto:infoappliances@fagoramerica.com)

## **CUSTOMER SERVICE**

Write the model and serial number on the lines below, you'll need them in the event of a service call. The model and serial number are located inside the door at the bottom

Model: \_\_\_\_\_

Serial: \_\_\_\_\_

Date Purchased: \_\_\_\_\_

Store: \_\_\_\_\_

Should you need service or have any questions about this product, don't hesitate to contact FAGOR AMERICA Customer Service at 1-800-207-0806

# OVENS

## ▶ CONTENTS

### GREETING

<b>1. IMPORTANT SAFETY NOTICES</b> .....	6
<b>2. INSTALLATION AND ASSEMBLY</b> .....	9
2.1. Unpacking .....	9
2.2. Connection to the mains electricity .....	9
<b>3. USING THE OVEN AND PRACTICAL TIPS</b> .....	12
3.1. Before using the oven for the first time .....	12
3.2. General description .....	13
3.3. Operating the oven .....	15
3.4. Accessories .....	16
3.5. Practical advice and cooking table .....	19
<b>4. OVEN CLEANING AND MAINTENANCE</b> .....	24
4.1. Cleaning .....	24
4.1.1. The outside of the oven .....	24
4.1.2. The inside of the oven .....	25
4.1.3. Accessories .....	28
4.1.4. Side grilles .....	28
4.2. Replacing the bulb of the interior light .....	29
<b>5. TROUBLESHOOTING</b> .....	30
<b>6. ENERGY-SAVING TIPS</b> .....	32
<b>7. STOP/START DIGITAL TIMER</b> .....	33
7.1. Clock .....	34
7.2. Timer Functions .....	35
7.3. Safety Functions .....	39
7.4. Timer Beeping .....	41





# GREETING

Dear client,

You are now the proud owner of a **FAGOR** oven and we would like to thank you for the confidence you have shown in us.

**FAGOR** provides you with a new generation of domestic appliances that contribute to an improvement in your quality of life thanks to our range of innovative, easy to use and environmentally-friendly products.

The range of **FAGOR** products offers you a wide selection of cooking hobs, range hoods, microwave ovens, dishwashers, washing machines, and refrigerators that you can combine with your new oven.

Before using your oven for the first time, we recommend you read the user manual carefully. You will find information you will need to make the most of your new **FAGOR** oven. Please pay special attention to all the safety advice and to the comments on how to use and care for your oven correctly.

At the same time, we recommend you keep this manuals in a safe place as you may find it useful in the future if you need to consult it. If you pass the appliance on to another person, please be sure to enclose the manual.

Warm greetings and welcome to the family of **FAGOR** clients.

**FAGOR** America Inc.

# ▶ 1. IMPORTANT SAFETY INSTRUCTIONS

When properly cared for, your new Fagor oven has been designed to be a safe, reliable appliance. Read all instructions carefully before using this oven. These precautions will reduce the risk of burns, electric shock, fire and injury to persons. When using kitchen appliances, basic safety precautions must be followed, including the following:

- This appliance must be properly installed and grounded by a qualified technician. Connect only to properly grounded outlet. See electric preparation and connection instructions in the Installation Instructions.
- This appliance should be serviced only by a qualified service technician. Contact the nearest authorized service center for inspection, repair or adjustment.
- Do not repair or replace any part of the oven unless specifically recommended. Refer service to an authorized service center.
- Do not operate this appliance if it is not working properly or if it has been damaged, until an authorized technician has inspected it.
- Install or locate this appliance only in accordance with the Installation Instructions.
- Use this oven only as intended by the manufacturer. If you have any questions, contact the manufacturer.
- Do not cover or block any openings on this appliance.
- Use this appliance only for its intended use as described in this manual. Do not use corrosive chemicals, vapors, or nonfood products in this appliance. This type of oven is specifically designed to heat or cook. It is not designed for industrial or laboratory use. The use of corrosive chemicals in heating or cleaning will damage the appliance.
- In the event that personal clothing or hair catches fire, DROP AND ROLL IMMEDIATELY to extinguish flames.
- This oven is intended for residential use only. It is not approved for outdoor use.

### **REGARDING PET BIRDS**

Birds have very sensitive respiratory systems. Keep pet birds out of the kitchen or other rooms where kitchen fumes could reach them. During Self- Clean mode, fumes that may be harmful to birds are released. Other kitchen fumes, such as from overheating margarines and cooking oils, may also be harmful.

- Do not allow children to use this appliance unless closely supervised by an adult. Children and pets should not be left alone or unattended in the area where the appliance is in use. Never allow children to sit or stand on any part of the oven.
- Do not store items of interest to children above the oven. If children should climb onto the appliance to reach these items, they could be seriously injured.

To reduce the risk of fire in the oven cavity:

1. Do not store flammable materials in or near the oven.
2. Do not use water on a grease fire. Smother fire or use a dry chemical or foam-type extinguisher.
3. Have a fire extinguisher readily available and highly visible next to any cooking appliance. Be sure you know how to use it.
4. Do not overcook food. Carefully attend oven if paper, plastic or other combustible materials are placed inside the oven.
5. Do not use the cavity for storage purposes. Do not leave paper products, cooking utensils or food in the cavity when not being used.
6. If materials inside the oven should ignite, keep oven door closed. Turn oven off and disconnect the circuit at the circuit breaker box.
7. Do not block any vent openings.
8. Be sure the blower fan runs when the oven is in operation. If the fan does not operate, do not use the oven. Call an authorized service center.
9. Never use the oven to warm or heat a room. This can damage the oven parts.
10. For personal safety, wear proper clothing. Loose fitting garments or garments with hanging sleeves should never be worn while using this appliance.

## **SAFETY PRECAUTIONS**

- Tie long hair so that it doesn't hang loose.
- The heating elements may be hot even though they are dark in color. Interior surfaces of an oven become hot enough to cause burns.
- During and after use, do not press or let clothing or other flammable materials contact the heating elements or the interior surfaces of the oven until they have had sufficient time to cool.
- The trim on the top and sides of the oven door may become hot enough to cause burns.
- Use care when opening the door. Open the door slightly to let hot air or steam escape before removing or replacing food.
- Do not heat unopened food containers. Buildup of pressure may cause the container to burst and result in injury.
- Always place oven racks in desired location while oven is cool. If a rack must be moved while oven is hot, do not let potholder contact the heating elements.
- Use only dry potholders. Moist or damp potholders on hot surfaces may result in burns from steam. Do not let potholders touch hot heating elements. Do not use a towel or other bulky cloth.



## 2. INSTALLATION AND ASSEMBLY

### 2.1. UNPACKING

1. Cut the plastic film covering the entire package.
2. Carefully remove all the oven's protective elements: top cover, edge protection and polystyrene base.

With respect to the conservation of the environment, we recommend you follow the advice given in section "6. Environmental Note".

### 2.2. CONNECTION TO THE ELECTRICAL MAINS

#### a Free-Standing Ovens 5HA-196 X

1. The measurements of the furniture unit in which the oven is to be mounted must coincide with those indicated in the diagrams, depending on whether the unit is wall-mounted or floor-based.

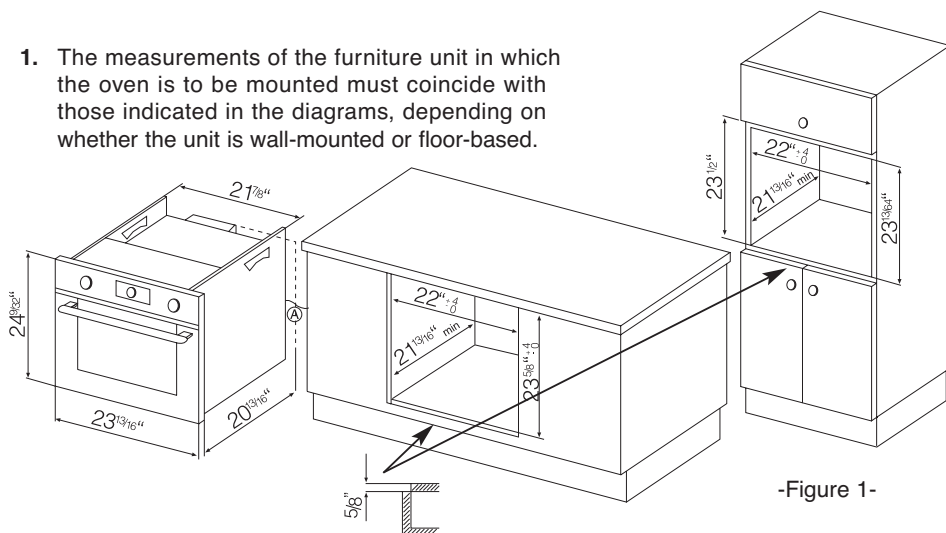

**b****Free-Standing Ovens 5HA-200 LX 5HA-200 RX****IMPORTANT:**

- The measurements of the figure 1 or 2 must be taken in consideration to mount the oven
- Once the oven is placed in the space, fasten it to the unit with the 2 "A"screws like in the figure.
- Do not hang from the door when it is opened.

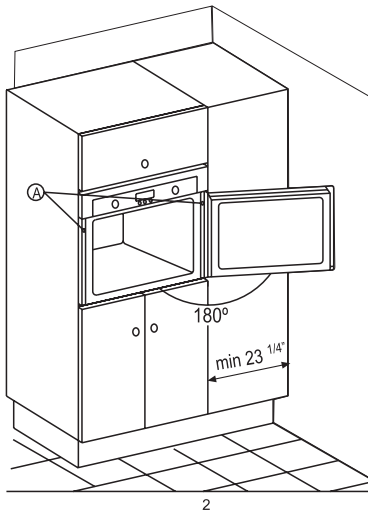
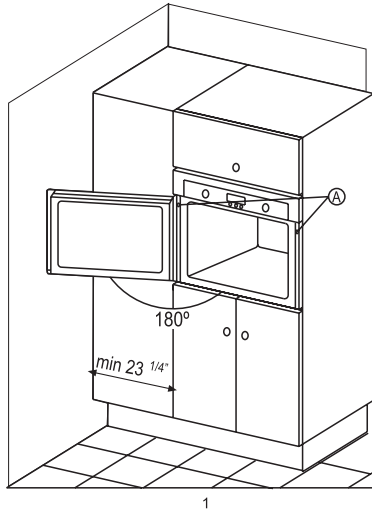

- At the back of the oven you will find cable “A” which is used to make the electrical connection in this way:

Oven Wire Color	House Wire Color
Black	Black (L1)
White	Red (L2)
Green/Yellow	White (Neutral) & Green/Cooper (Ground)

**WARNING:** before starting to make any connections, check the following:

- that the mains voltage corresponds to the voltage indicated on the feature identification plate **B**, figure 2.
- that the electrical mains the oven is to be connected to is powerful enough for the maximum power the oven absorbs, indicated on the feature identification plate.

ELECTRICAL SPECIFICATIONS			
Model	Volts	Watts	Amps
5HA-196 X 5HA-200 LX 5HA-200 RX	240	3,6 KW	15

- After it is plugged in, place the oven into the gap, taking special care not to leave any surplus cable on top of the oven.

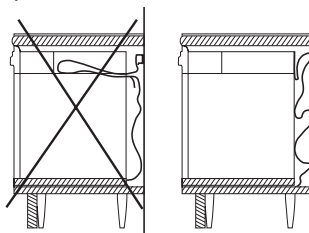

- A switch must be placed in the most accessible site possible in order to disconnect the oven, with a minimum of 3 mm between the contacts.
- Fasten the oven to the unit with the 2 screws provided.

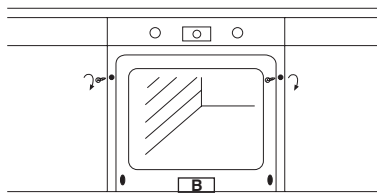

-Figure 2-

- If the cooking function selector is not at position “0”, turn it to “0” and set the time on the oven( section 7.1).

## ▶ 3. USING THE OVEN AND PRACTICAL TIPS

### 3.1. BEFORE USING THE OVEN FOR THE FIRST TIME

#### Adjusting the Clock

If the programmer on your new oven includes a clock, we recommend that you set the correct time (section 7.1) after connecting the oven to the electrical mains or after a cut in the power supply.

#### First Cleaning

Before using your new oven for the first time, make sure you have removed any possible labels or protective plastic. Heat it up with nothing in it for about 30 minutes, with the door closed. Adjust the cooking functions selector in position  and set a temperature of 500°F.

At the beginning, the oven may give off a strange smell. Furthermore, you may notice a little smoke. All of this is normal. This is the way to remove any possible remains of grease from the inside of the oven left over from the manufacturing process. Once the oven has cooled down, clean it following the instructions given in section "4. Cleaning and Maintenance".

Before using any of the accessories for the first time, clean with water, a little soap and a cloth.

## 3.2. GENERAL DESCRIPTION

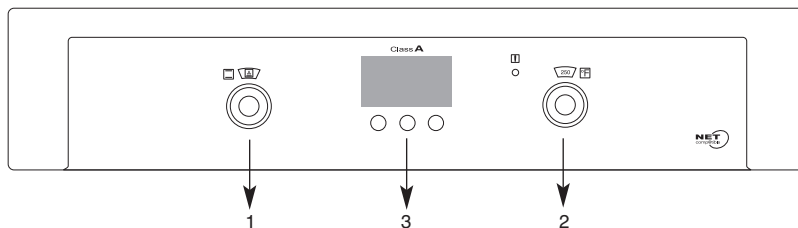

1. Function Selector
2. Temperature Selector
3. Programmer

### a Cooking Function Selector





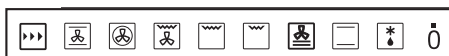



Your oven offers different cooking functions. With the cooking function selector, you will be able to select the most suitable cooking function at any time for the preparation of the food in question.

If your oven has retractable controls, the cooking function selector can be turned to the left or right without any problem. These controls can be hidden and revealed again in any position by just pushing the control.



\*Number of functions differ depending on the model.

Read below only the description of those functions coinciding with the symbols appearing on your function selector:

-  **Traditional Heat:** With this function, the heat comes from both above and below, heating the food in the traditional way.
  
-  **Gentle Grill or Gentle Grill with rotating spit:** Only the central part of the grill resistance is connected, allowing you to save power when toasting smaller portions of food. Place the items in the central part of the grill.
  
-  **Strong Grill:** The action of the grill covers the entire surface of the tray, allowing you to toast large trays or several items of food at the same time. This setting is suitable for cooking the same food as with the gentle grill but covering the whole entire surface of the tray. Very appropriate for all types of toasting.
  
-  **Strong Grill with Fan:** Special option that allows toasting of food and an even distribution of the heat with a fan. Ideal for grilling large roasts. In this way, roast meats take on a golden colour all over
  
-  **Traditional Heat with Fan:** The heat comes from both the top and the bottom of the oven and the fan distributes the temperature evenly. You can cook different dishes on different levels at the same time without mixing smells or flavours.
  
-  **Thawing:** This heats the resistances to a very low temperature, so as to achieve an even and fast thawing of frozen food. The thawing function can be used with any type of frozen food.
  
-  **Turbo Plus:** The oven is heated with the circular resistance located at the back. The fan drives the hot air around the oven to distribute the heat more evenly. Ideal for working with different trays at various heights.
  
-  **Pizza:** The strong heat coming from the bottom and the even distribution of the temperature from the fan gives pizzas a particularly crispy base.
  
-  **Celeris:** Suitable for those dishes that need the oven to be pre-heated. With this function the oven is heated to the chosen temperature in as little time as possible. Once the oven has reached the temperature set, the thermostat pilot light goes out, indicating that the oven is ready to be used for any other cooking function.

The **general power pilot light** will remain on whenever any cooking function is selected.



## b Temperature Selector

With the temperature selector, you can adjust the cooking temperature at any time to the most suitable for preparing the food in question. The controls turn to the right from 100°F up to 500°F.

The **thermostat pilot light** will go out when the selected temperature is reached and then it will come on and off from time to time while cooking to keep the right temperature.

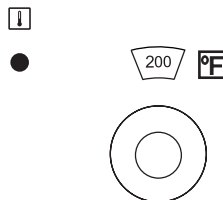

## 3.3. OPERATION OF THE OVEN

Follow these steps to turn on your oven:

1. Place the food in the oven, on the recommended tray and level (see tables on pages 20-23).

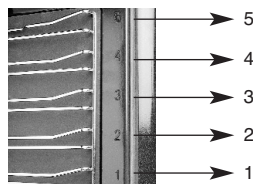

2. Select a cooking function using the cooking function selector (see tables on pages 20-23). For example: 



3. Set a temperature by turning the temperature selector or following the instructions given in the timer operating section (see tables on pages 20-23). For example: 400°F.

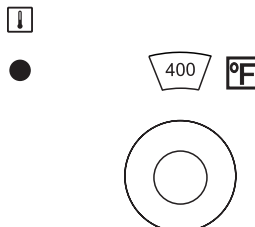

4. To set the programmer, follow the instructions provided in the specific user manual.
5. Once the cooking is finished, do not forget to turn the function selector back to the "0" position and the temperature selector to the lowest position "■"

## 3.4. ACCESORIES

The oven has 5 different levels on which to place the accessories. These levels are engraved at the entrance to the cavity. If you wish, you can acquire additional accessories by requesting them from our Official Technical Service.

Your oven comes from the factory with some of the accessories described below:

### Baking Tray

Aluminium tray ideal for baking.



### Standard Tray

For all kinds of food.



### Deep Tray

The new deep tray is suitable for cooking dishes with a large amount of sauce or gravy, ideal for juicy cakes, frozen food and large roasts.





## Grille with Non-Tip Safety Catch

The new grille with its non-tip safety catch can be slid out of its housing about three quarters of the way without it tipping over.

You will be able to remove food easily from inside the oven. In addition, it gives you the possibility of using it at any of the 5 levels available in the oven.

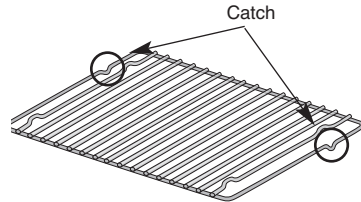

This grille can be used to hold any kind of container with food to be roasted or toasted. It is also used for making roasts directly on the slats of the grille, in which case we recommend you place a tray underneath the grille to collect any juices given off by the meat and to keep your oven clean.

The grille has to be slid into place on the side slots with the catches facing down, as indicated in the figure.

## Removable tray, Total Accessibility

With the new "Removable tray, Total Accessibility", food handling is more convenient and easier thanks to the carefully studied design allowing the trays to slide in and out smoothly.

The trays can be taken completely out of their housing for total accessibility. In addition, they remain totally stable so that you can work and handle them in total safety, reducing the risk of burns.

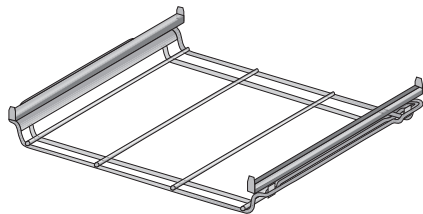

This will make it easier for you to remove food from inside the oven.

This new total extraction system can be placed on any of the bottom 4 levels of the oven, multiplying the cooking potential even more.

### Inserting the trays inside the oven:

1. Insert the “Removable tray, Total Accessibility” onto the side slots as far as it will go; you will have to raise it lightly to get past the catches. Bear in mind that the round pegs go on the back.
2. Next, pull out the telescopic runners as far as they will go.
3. Then fit any of the trays inside the 4 upper catches on the telescopic runners.

If you wish you can also insert the grille with its non-tip safety feature on top of the combination of the “Removable Tray”, but with the catches facing upwards.

4. Insert the whole set inside the oven completely.

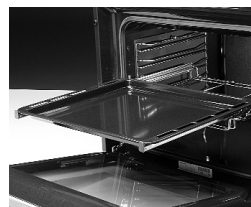
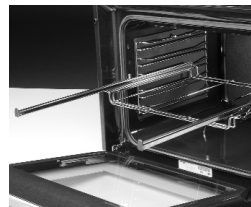

### Removing the trays from inside the oven:

Once cooking has been completed, slide the tray and grille set out, you can then do one of two things, as required:

- a. Remove only the tray from inside the oven.
- b. Remove the whole set from inside the oven. To do so, you will have to lift the “Removable tray, Total Accessibility” slightly to get past the catches that prevent it from tipping over.

Remember that the “Removable tray, Total Accessibility” set of tray and/or grille with its non-tip safety feature can be placed on any of the 5 lower levels.





















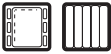

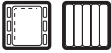













## 3.5. PRACTICAL ADVICE AND COOKING TABLE











































### a Suggestions and Practical Tips for Baking











































PROBLEM	POSSIBLE REASON	SOLUTION
Cakes and pastries do not rise enough	<ul style="list-style-type: none"><li>•Wrong function selected</li><li>•The oven has not been pre-heated enough</li></ul>	<ul style="list-style-type: none"><li>•Check the function selected against the temperature shown in the table</li><li>•Check the table for any pre-heating recommendations</li></ul>
The roast or the baking is very pale	<ul style="list-style-type: none"><li>•Temperature too low</li><li>•Inappropriate mold material</li></ul>	<ul style="list-style-type: none"><li>•Check the temperature selected against the temperature shown in the table; increase it slightly if necessary</li><li>•Use only dark molds</li></ul>
The roast or the baking is very dark	<ul style="list-style-type: none"><li>•Temperature too high</li></ul>	<ul style="list-style-type: none"><li>•Check the temperature selected against the temperature shown in the table; reduce it slightly if necessary</li></ul>
The roast or the baking is very dry	<ul style="list-style-type: none"><li>•The cooking time is very long because the temperature selected is too low</li></ul>	<ul style="list-style-type: none"><li>•Check the temperature selected against the temperature shown in the table</li></ul>
The roast or the baking is very wet	<ul style="list-style-type: none"><li>•Too much liquid in the dough</li></ul>	<ul style="list-style-type: none"><li>•Check the temperature selected against the temperature shown in the table; increase it slightly if necessary.</li><li>•Prepare the dough with less liquid.</li></ul>











































## b

## Tables

FOOD	PROGRAM	TEMPERATURE	TIME	FOOD POSITION	PRE-HEATING	ACCESSORIES
<b>MEAT AND POULTRY</b>						
Veal 3,31 lb		210°C 410°F	50-60 min	 1	No	
Pork loin 3,31 lb		220°C 428°F	50-60 min	 2	No	
Roasted chicken 2,76 lb		230°C 446°F	50-60 min	 1	No	
Roasted rabbit 2,64 lb		210°C 410°F	25-35 min	 2	No	
Roasted lamb 2,2 lb		220°C 428°F	40-50 min	 2	No	
Pork leg 3,31 lb		180°C 356°F	85-95 min	 2	No	
Pork ribs 3,31 lb		220°C 428°F	30-40 min	 2	No	
Turkey legs (2)		170°C 338°F	40-50 min	 2	No	
Turkey 8,8 lb		190°C 374°F	115-125 min	 1	No	
<b>DESSERTS</b>						
Caramel custard		150°C 302°F	30-40 min	 1	No	
Sponge cake		180°C 356°F	25-35 min	 1	Yes	
Pears baked in wine		240°C 464°F	50-60 min	 2	No	
Pastries		220°C 428°F	8-12 min	 2	No	

FOOD	PROGRAM	TEMPERATURE	TIME	FOOD POSITION	PRE-HEATING	ACCESSORIES
<b>STARTERS AND VEGETABLES</b>						
Stuffed aubergines		220°C 428°F	12-16 min	 2	Yes	
Roasted red peppers 2,76 lb		210°C 410°F	30-40 min	 2	No	 
Stuffed tomatoes (4)		220°C 428°F	15-19 min	 2	No	
Stuffed courgettes (2)		200°C 392°F	25-35 min	 1	No	
<b>FISH AND SEAFOOD</b>						
Roast hake 3,31 lb		230°C 446°F	7-9 min	 2	Yes	
Baked prawns 2,2 lb		240°C 464°F	4 min	 4	Yes	
Trout 2,2 lb		250°C 482°F	9-11 min	 3	Yes	
Tuna fillets		230°C 446°F	10-14 min	 3	No	
Roasted fish 2,2 lb		220°C 428°F	13-17 min	 2	No	
Baked salmon (4)		250°C 482°F	8-10 min	 3	Yes	
Baked cod 3,31 lb		220°C 428°F	7-9 min	 2	Yes	
<b>VARIOUS</b>						
Pizza		220°C 428°F	18-22 min	 1	Yes	
Bread		220°C 428°F	18-22 min	 2	No	
Buns		210°C 410°F	15-19 min	 2	Yes	

FOOD	PROGRAM	TEMPERATURE	TIME	FOOD POSITION	PRE-HEATING	ACCESSORIES
<b>MEAT AND POULTRY</b>						
Veal 3,31 lb		190°C 374°F	50-60 min		No	
Pork loin 3,31 lb		200°C 392°F	50-60 min		No	
Roasted chicken 2,76 lb		210°C 410°F	50-60 min		No	
Roasted rabbit 2,64 lb		230°C 446°F	25-35 min		No	
Roasted lamb 2,2 lb		200°C 392°F	40-55 min		No	
Pork leg 3,31 lb		150°C 302°F	85-95 min		No	
Pork ribs 3,31 lb		200°C 392°F	30-40 min		No	
Turkey legs (2)		150°C 302°F	40-50 min		No	
Turkey 8,8 lb		170°C 338°F	115-125 min		No	
<b>DESSERTS</b>						
Caramel custard		150°C 302°F	30-40min		No	
Sponge cake		180°C 356°F	15-25min		No	
Pears baked in wine		220°C 428°F	50-60min		No	
Pastries		200°C 392°F	8-12min		No	
<b>THAWING</b>						
For all kinds of food		75°C 165°F			No	

FOOD	PROGRAM	TEMPERATURE	TIME	FOOD POSITION	PRE-HEATING	ACCESSORIES
<b>STARTERS AND VEGETABLES</b>						
Stuffed aubergines		200°C 392°F	12-16 min	 2	Yes	
Roasted red peppers 2,76 lb		190°C 374°F	30-40 min	 2	No	
Stuffed tomatoes (4)		200°C 392°F	15-19 min	 2	No	
Stuffed courgettes (2)		180°C 356°F	25-35 min	 1	No	
<b>FISH AND SEAFOOD</b>						
Roast ed hake 3,31 lb		210°C 410°F	7-9 min	 2	Yes	
Baked prawns 2,2 lb		220°C 428°F	4 min	 4	Yes	
Trout 2,2 lb		240°C 464°F	9-11 min	 3	Yes	
Tuna fillets		250°C 482°F	10-14 min	 3	No	 
Roasted fish 2,2 lb		200°C 392°F	13-17 min	 2	Yes	
Baked salmon (4)		240°C 464°F	8-10 min	 3	Yes	
Baked cod 3,31 lb		210°C 410°F	7-9 min	 2	Yes	
<b>VARIOUS</b>						
Pizza		200°C 392°F	18-22 min	 2	No	
Bread		200°C 392°F	18-22 min	 2	No	
Buns		220°C 428°F	13-17 min	 2	Yes	

## ▶ 4. OVEN CLEANING AND MAINTENANCE

### 4.1. CLEANING

#### 4.1.1. The Outside of the Oven

**Ovens with stainless-steel front:**

Clean the outside of the oven preferably with warm water and a little washing liquid. Abundant rinsing is recommended. Dry it immediately afterwards with a soft cloth.

If any stains are difficult to remove we recommend you use products specifically designed for stainless steel. Test the product on a small area before you apply it to the entire surface. Follow the manufacturer's indications closely.



## 4.1.2. The Inside of the Oven

In order to ensure the continued aesthetic attractiveness of your oven in the long term, you should clean the inside of it regularly, preferably every time you use it; this way you will avoid the generation of smoke and unpleasant odours in subsequent uses.

### a. Ovens with “Slide” enamel:

Our new “Slide” enamel ensures minimal adherence of any food to the internal surfaces of the oven, becoming easy to clean. Clean the inside of the oven while it is still warm using hot water with a little soap or a solution of water and vinegar; after cleaning, dry the inner walls thoroughly with a soft cloth.

For in-depth cleaning or if the dirt is particularly difficult to remove, we recommend the use of specialized oven-cleaners, following the manufacturer’s instructions. Only use specialized oven-cleaners on a cold oven.

### b. Ovens with self-cleaning panels:

In ovens with self-cleaning panels the rear plate and the side panels are coated with a self-cleaning enamel that eliminates fat and grease while the oven is operating. These side panels are reversible, which doubles the lifetime of their catalytic coating.



Sometimes, the largest splashes do not disappear until the oven has been turned on and off several times. When the self-cleaning elements of your oven no longer clean themselves well enough, it will be necessary to regenerate them. To do so, please follow the steps outlined below:

1. Remove the accessories and containers from the inside of the oven.
2. Thoroughly clean the oven surfaces that are not self-cleaning.
3. Place the function selector to position .
4. Adjust the oven temperature to 500°F.
5. We recommend you leave the oven operating for between 30 and 60 minutes, depending on the degree of dirt and grime on the self-cleaning parts.
6. Clean off any remnants of salt from the self-cleaning elements using a slightly damp sponge (water only).

The self-cleaning elements of the oven will be completely functional again.

**WARNING:** Never clean the rear plate or the side panels with special oven-cleaners.

If you wish to clean the side walls on the inside of the oven, you will first have to take out the grilles and the self-cleaning panels located behind them (follow the instructions given in the section “4.1.4. How to clean the side grilles”).

Clean the side walls on the inside of the oven while it is still warm using hot water with a little soap; dry the walls carefully with a soft cloth.

For in-depth cleaning or if the dirt is particularly difficult to remove, we recommend the use of specialised oven-cleaners, following the manufacturer's instructions. Only ever use specialized oven-cleaners on a cold oven.

**WARNING:** Never apply this product to the oven's self-cleaning surfaces.

#### **Making the cleaning of the inside of the oven easier:**

- Connect the interior lamp. To do so: turn the temperature selector to the “0” position and the function selector to any function, the light will then be on.
- If you want to clean the glass cover protecting the oven lamp: unscrew the cover and clean it, preferably with washing liquid.



Once it is clean, replace the lamp cover following the procedure described.

## Model 5HA-196 X

- It is possible to remove the oven door easily. Follow the steps described below very carefully:

Removing the door:

1. Open the door fully.

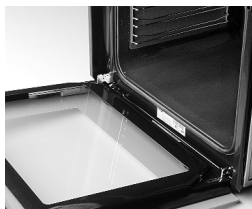

2. Completely unscrew the bolts in the hinges.

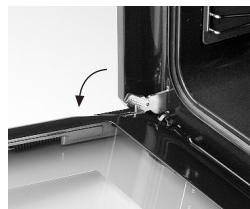

3. Close the oven door gently until you hear the catch engage; once you reach the position of the catch, take hold of the door with both hands and continue to push it closed while pulling upwards at the same time to lift the hinges from their slots. The door will then be released.

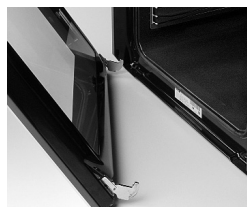

Installing the door after cleaning:

1. Align the hinges with their slots until they hook into place, as indicated in the figures.



2. Open the door fully, and push the bolts down completely to their original position. The door will then be correctly installed.

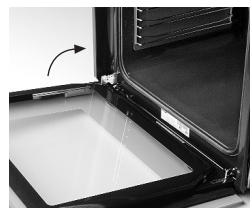

- In some ovens it is possible to fold down the grill in the roof of the oven.  
**WARNING:** the oven must be cold.

Folding the grill down:

1. Lift up the grill rod.
2. Press it in towards the back of the oven.

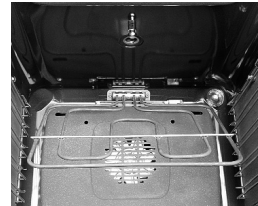

Re-inserting the grill after cleaning:

1. Press the grill's rod towards the back of the oven and hook the grill back into place in its support.

### 4.1.3. Accessories

Soak the accessories immediately after use in a normal household detergent. Any adhered food scraps can be easily removed with a sponge or a soft brush.

### 4.1.4. Side Grilles

The grilles can be removed for cleaning. To do so, follow the steps described below:

Removing the grilles:

1. Press the grille's upper rod downwards to unhook it from the support on the side panel.



2. Turn the grille as shown in the figure and pull it outwards to remove it.

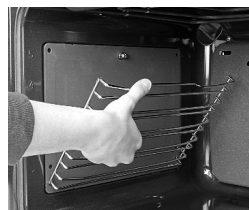

3. If your oven is self-cleaning, unhook the panel located behind the grille.

Clean the grilles in the dishwasher. To eliminate any stubborn dirt you can use rougher cleaning sponges or brushes.

Re-inserting the grilles after cleaning:

Replace the grilles on the side walls by following the steps indicated above but in reverse order.

## 4.2. REPLACING THE BULB OF THE INTERIOR LIGHT

You can replace the bulb for the oven's interior light if it stops working. You can obtain heat-resistant 25W replacement bulbs capable of withstanding 600°F from the Official Technical Service or from a specialized electrical store. To replace the bulb do the following:







1. Disconnect the oven from the power mains. If necessary, let the oven cool down.
2. Unscrew the cover over the lamp by turning it to the left.
3. Replace the bulb with one of the same type.
4. Replace the glass cover on the lamp following the procedure described.
5. Re-connect the oven to the power mains.



## 5. TROUBLESHOOTING

There may be small anomalies that do not necessarily mean the existence of a product failure and so do not require a Technical Service call.

These small anomalies are often easy to correct. In order to avoid an unnecessary call of a Service Engineer, check to see if the failure you have encountered is included in the table below:

YOU NOTICE THAT...	POSSIBLE REASONS	WHAT TO DO
The oven is NOT working. The luminous symbols are not lit.	<ul style="list-style-type: none"> <li>•No power supply.</li> <li>•The oven is not connected.</li> </ul>	<ul style="list-style-type: none"> <li>•Check the status of the electrical installation.</li> <li>•Connect the oven.</li> </ul>
The oven is NOT working.	<ul style="list-style-type: none"> <li>•The timer control is in position "0" or </li> </ul>	<ul style="list-style-type: none"> <li>•Turn the selector manually  or set the desired cooking time.</li> </ul>
The oven is making a series of beeps.	<ul style="list-style-type: none"> <li>•Several reasons.</li> </ul>	<ul style="list-style-type: none"> <li>•Read the timer's user manual carefully.</li> </ul>
The oven is NOT working.  symbol is flashing.	<ul style="list-style-type: none"> <li>•Several hours have passed with the oven operating, without any timer button being pressed.</li> <li>•Interruption of the power supply, with the function selector not in position "0".</li> <li>•Oven installed with the function selector not in position "0".</li> </ul>	<ul style="list-style-type: none"> <li>•Turn the function selector to the "0" position.</li> <li>•Turn the function selector to the "0" position and set the clock to the right time.</li> </ul>
The oven is NOT working.  symbol is flashing.	Oven just installed, or interruption in the power supply, with the function selector not in position "0".	Set the clock to the right time and the oven will start.
The oven is NOT working.  symbol is flashing.	The time pre-set for cooking has elapsed.	Turn the function selector and The temperature selector to the "0" position.
The oven is NOT working.  symbol is lit.	Oven blocked with the function selector in position "0".	Release the timer as indicated in the "Child Safety Lock" part of the timer's user manual.
The oven IS working, but the  symbol is flashing.	The time set for the oven alarm has elapsed.	Press any button.
The oven light is NOT working.	<ul style="list-style-type: none"> <li>•The lamp is not operational.</li> <li>•The oven is not connected or your electrical system has a fault and the fuse has tripped.</li> </ul>	<ul style="list-style-type: none"> <li>•Change the bulb.</li> <li>•Connect the oven or check if the fuse has tripped.</li> </ul>
Smoke comes out when in use.	<ul style="list-style-type: none"> <li>•Oven temperature is too high.</li> <li>•Greasy oven.</li> </ul>	<ul style="list-style-type: none"> <li>•Reduce the oven temperature.</li> <li>•Clean the oven.</li> </ul>
The oven makes a noise after cooking is completed.	The oven fan is operating (even with the oven off), to cool down the temperature in the surroundings.	This is absolutely normal.
The interior glass of the oven door is misted up and dripping.	An accessory (grille, tray) is in contact with the glass.	Push the accessory further in to prevent it coming into contact with the glass.

## 6. ENERGY-SAVING TIPS

- Pre-heat the oven only where this is indicated in the recipe or in the cooking table for the dish you want to make.
- It is better to use dark baking molds, preferably enamelled in black, as these materials absorb heat particularly well.
- If you wish to bake a batch of several cakes, you should do so one after the other. As the oven is already hot, the baking times of second and subsequent cakes are shorter. You can also prepare two cakes simultaneously by placing rectangular molds side by side.
- If using the oven continuously for a long time, you can switch it off 5 or 10 minutes before the time indicated and take advantage of the residual heat to finish preparing the food.
- If your oven includes the “Gentle Grill” function, use it to prepare small amounts of grilled food, placing the food in the central part of the tray or grille.



## ▶ 7. STOP/START DIGITAL TIMER

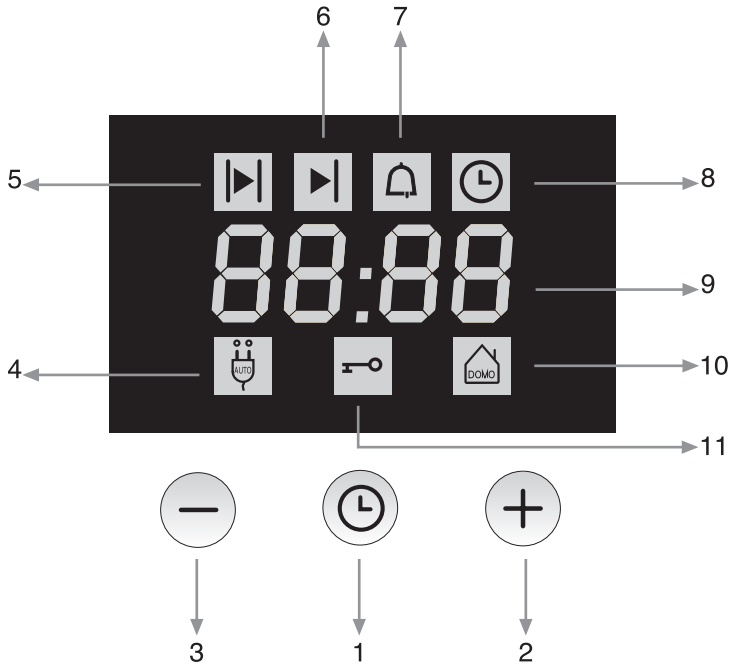

1. Timer function selector button
2. "+" button
3. "-" button
4. Automatic disconnection indicator symbol
5. Cooking duration indicator symbol
6. Stop Cooking time indicator symbol
7. Beeper indicator symbol
8. Time adjustment indicator symbol
9. Screen
10. NET Compatible oven indicator symbol
11. Child safety lock indicator symbol

Note:military time

## 7.1 CLOCK

When the oven is connected to the mains electricity or following an interruption in the power supply, the symbol  will flash, providing that the function selector is in the "0" position; if not, turn the selector to "0" and follow the procedure described below to set the time.



WRONG





RIGHT

### To set the time:

1. Press the  button and the symbol  will start flashing.



2. Set the time by pressing the  and/or  buttons.  
Example: Current time 12:30:00.

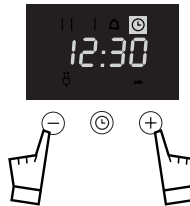



After a few seconds the  symbol will go off and the screen will display the time set. The appliance will be ready for use.

## 7.2 TIMER FUNCTIONS



### a “Cooking Duration”

With this function, the oven turns itself off automatically when the pre-set cooking time has elapsed.

**To set the cooking duration time:**

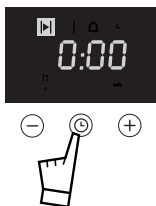
1. Select a cooking function and set a temperature.
2. Press the button  and the  symbol will start flashing.





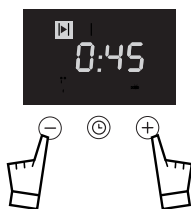

3. Set the desired duration by pressing the  and/or  buttons (maximum 10 hours).

Example: I want the timer to operate the oven automatically for 45 minutes.



After a few seconds, the function will be activated, the oven will start working, the  symbol will remain lit and the screen will display the time remaining until conclusion of the cooking.



If you wish to display the time, press the  button several times until the  symbol flashes. The screen will display the current time for a few seconds and will then go back to displaying the countdown of time remaining before cooking finishes.

Once the pre-set time has elapsed, the oven will turn itself off automatically and start to beep for 60 seconds while the symbol  flashes. After this time, the oven will stop beeping but the symbol  will continue to flash. Press any button to stop it flashing.





If you wish to stop the beeping before the 60 seconds are up, press any button.

**WARNING:** when you do this, the oven will automatically switch to manual operation and will continue working. Therefore, if you wish to stop cooking, do not forget to turn the function selector and the temperature selector to the “0” position.

### To change the cooking duration time:

Press the button  and the symbol  will start flashing. Change the time by pressing the  and/or  buttons.



### To cancel the cooking duration time:

1. Press the button  and the symbol  will start flashing.
2. Press the button  until the time displayed on the screen is “0:00”. After a few seconds the symbol  will go off and the screen will display the current time. The cooking duration function will have been cancelled.

## **b** “Auto-Stop Cooking”



With this function, you can set your oven to switch itself off automatically at a particular time. The “auto-stop cooking” function is used simultaneously with the “cooking duration” function so that the oven switches itself on and off automatically after operating for the desired time.

### To set the auto-stop cooking time:

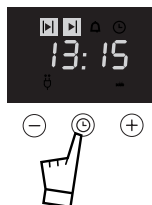

1. Select a cooking function and set a temperature.
2. After you have set the cooking duration time, press the button  and the symbol  will start flashing.

Example: Current time 12:30, cooking time pre-set for 45 minutes.







3. Set the time you want cooking to stop by pressing the  and/or  buttons. Example: I want cooking to be finished by 2:30. After a few seconds the function will be activated and the oven will start working as programmed.







Once the oven has started operating, the screen will display the time remaining until conclusion of the cooking. If you wish to display the time, press the  button several times until the  symbol flashes. The screen will display the current time for a few seconds and will then go back to displaying the countdown of time remaining before cooking finishes.

Once the pre-set time has elapsed, the oven will turn itself off automatically and start to beep while the  symbol flashes. To switch it off, press any button; **WARNING:** when you do this, the oven will automatically switch to manual operation and will continue working. Therefore, if you wish to stop cooking, do not forget to turn the function selector and the temperature selector to the "0" position.

#### To change the auto-stop cooking time:

Press the  button until the  symbol starts blinking. The screen will show the time when the cooking will finish, you can modify it pushing the  and/or  buttons.

#### To cancel the auto-stop cooking time:

1. Press the  button until the  symbol starts flashing. The screen  will display the time cooking is to stop.
2. Press the  button until the time indicated on the screen changing. It will then be showing the current time plus the pre-set cooking duration time. The auto-stop cooking function will have been cancelled but the oven will start operating in line with the pre-set cooking duration time.



## C Timer

The oven has a built-in countdown beeper function. This works with the oven on or off as it has no impact on the operation of the appliance. In this way, you can use it for any oven operation or for any other matter.

## To set the Timer:

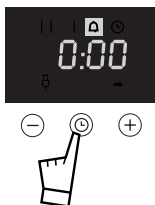
1. Press the button several times  until the  symbol starts flashing.



2. Set the countdown time by pressing the  and/or  buttons.  
Example: I want the timer to ring in 45 minutes. After a few seconds, the function will be activated, the  symbol will remain lit and the screen will go back to its previous situation.

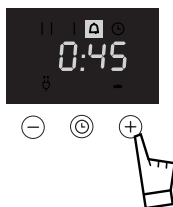





Once the time set has elapsed, the oven will start to beep for 60 seconds while the symbol flashes. After this time, the oven will stop beeping but the  symbol will continue to flash. Press any button to stop it flashing.

If you wish to stop the beeping before the 60 seconds are up, press any button.



**WARNING:** If the oven is working, remember that the beeper function does not stop it operating. Therefore, if you wish to stop cooking, do not forget to turn the function selector and the temperature selector to the "0" position.

**To change the countdown time,** follow the procedure described for setting the timer.

## To cancel the timer:

1. Press the button several times  until the symbol starts flashing  .
2. Press the  button until the time displayed on the screen is "0:00". After a few seconds the  symbol will go off and the screen will go back to its previous situation. The beeper function will have been cancelled.

**d****“Cancellation of timer functions”**

If you wish to cancel all the timer functions set, press the  button for a few seconds. The  symbols corresponding to these functions will turn off to indicate that they are not active.

If the oven is on at the time, then it will continue operating manually once the timer functions have been cancelled; if you want to switch it off, turn the selector function to the “0” position.

**WARNING:** Switching the oven off by turning the selector function to the “0” position cancels all the timer functions except the “Beeper” function as this works with the oven on or off.

## 7.3 SAFETY FUNCTIONS

**a****“Automatic Power-Off”**

If you have not pressed any timer button for few hours with the oven on, then it will turn itself off automatically for safety reasons. When the oven has been turned off in this way, it will beep to indicate the error and the  symbol will start to flash.

To disable this automatic power-off indication, turn the selector function to the “0” position and the  symbol will stop flashing.

**b****“Child Safety Lock”**

You can block the oven timer so that it cannot be manipulated by children.

### To set the timer blocking mechanism:

Press both the **+** and the **-** buttons simultaneously for a few seconds until the  symbol remains lit. The oven timer will be blocked.

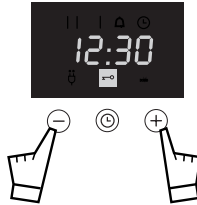

If the cooking function selector was at the "0" position when the timer was blocked, then it will not be possible to turn the oven on. If on the other hand the oven was working at the time, you will be able to change the selected cooking function and set the temperature but you will not be able to operate the timer.

### To release the timer blocking mechanism:



Press both the **-** and the **+** buttons simultaneously for a few seconds until the  symbol goes off. All of the timer functions will then be available again.



## 7.4 TIMER BEEPING



You have the option of turning off timer beeping sound. To do so, proceed as follows:

### To turn beeping off:

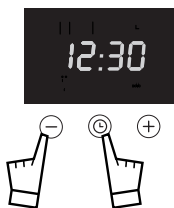
Press the  button and, holding it down, press the  button for a few seconds. Beeping will be turned off.



### To turn beeping on:

Press the  button and, holding it down, press the  button for a few seconds. Beeping will be turned on again.

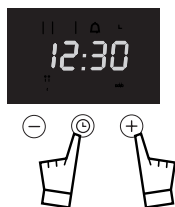



# FOURS

## SOMMAIRE

### MESSAGE DE BIENVENUE

<b>1. INSTRUCTIONS DE SÉCURITÉ IMPORTANTES</b>	.46
<b>2. INSTALLATION ET MONTAGE</b>	.49
2.1. Déballage	.49
2.2. Branchement au réseau électrique	.49
<b>3. UTILISATION DU FOUR ET CONSEILS PRATIQUES</b>	.52
3.1. Avant d'utiliser le four pour la première fois	.52
3.2. Description générale	.53
3.3. Fonctionnement du four	.55
3.4. Accessoires	.56
3.5. Conseils pratiques et table de cuisson	.59
<b>4. NETTOYAGE ET ENTRETIEN</b>	.64
4.1. Comment nettoyer	.64
4.1.1. L'extérieur du four	.64
4.1.2. L'intérieur du four	.65
4.1.3. Les accessoires	.68
4.1.4. Les grilles latérales	.68
4.2. Comment remplacer la lampe du four	.69
<b>5. LOCALISATION ET RÉOLUTION DES PROBLÈMES</b>	.70
<b>6. CONSEILS POUR ÉCONOMISER DE L'ÉNERGIE</b>	.72
<b>7. PROGRAMMATEUR DIGITAL DE MARCHE/ARRÊT</b>	.73
7.1. Horloge	.74
7.2. Fonctions de Temps	.75
7.3. Fonctions de Sécurité	.79
7.4. Signaux sonores émis par le programmeur	.81





# MESSAGE DE BIENVENUE

Cher Client,

Vous venez d'acquérir un four **FAGOR** et nous vous remercions de votre confiance. FAGOR met à votre disposition une nouvelle génération d'appareils électroménagers qui contribuent à améliorer votre qualité de vie grâce à une gamme de produits innovants, faciles à utiliser et respectueux de l'environnement.

La gamme de produits **FAGOR** vous offre un grand choix de tables de cuisson, de hottes, de micro-ondes, de lave-vaisselle, de lave-linge et de réfrigérateurs que vous pourrez combiner avec votre nouveau four.

Nous vous recommandons de lire attentivement les manuels d'utilisation avant d'utiliser le four. Vous y trouverez toute l'information nécessaire pour pouvoir utiliser les fonctions de votre four **FAGOR**. Lisez avec une attention toute particulière les conseils relatifs à la sécurité, à l'utilisation et à l'entretien appropriés du four.

En outre, nous vous conseillons de conserver ces manuels pour les consulter ultérieurement en cas de besoin. Si vous livrez cet appareil à une autre personne, n'oubliez pas d'y joindre les manuels d'utilisation.

Merci d'être un client **FAGOR**. Cordialement,

La marque **FAGOR**.

# ▶ 1. INSTRUCTIONS DE SÉCURITÉ IMPORTANTES

Lorsque entretenu adéquatement, ce nouveau four Fagor est conçu pour la fiabilité et la sécurité. Lire attentivement toutes les instructions avant d'utiliser le four. Ces précautions permettent de réduire le risque de brûlures, de chocs électriques, d'incendie et de blessures. Au moment d'utiliser un appareil de cuisine, les précautions de sécurité de base doivent être observées, incluant ce qui suit :

- Cet appareil doit être adéquatement installé et mis à la terre adéquatement par un technicien qualifié. Brancher seulement sur une prise mise à la terre. Voir les instructions de connexions et de préparation électrique dans les instructions d'installation.
- Le service de cet appareil doit être effectué seulement par un technicien qualifié. Communiquer avec un centre de service autorisé pour vérification, réparation ou réglage.
- Ne pas réparer ni remplacer toute pièce du four à moins qu'il ne soit indiqué spécifiquement indiqué. Référer tout service à un centre de service autorisé.
- Ne pas utiliser cet appareil s'il ne fonctionne pas adéquatement ou s'il a été endommagé tant qu'un technicien qualifié ne l'a pas vérifié.
- Installer cet appareil conformément aux instructions d'installation.
- Utiliser ce four seulement pour l'usage auquel il est destiné par le fabricant. Pour toute question, communiquer avec le fabricant.
- Ne pas couvrir ni obstruer les ouvertures de cet appareil.
- Utiliser cet appareil seulement pour l'usage auquel il est destiné décrit dans ce guide. Ne pas utiliser de produits chimiques corrosifs, vapeurs ou non alimentaires dans cet appareil. Ce type de four est conçu spécifiquement pour chauffer et cuire. Il n'est pas conçu pour une utilisation commerciale ou en laboratoire. L'utilisation de produits chimiques corrosifs pour le chauffage et le nettoyage endommagera cet appareil.
- Si les vêtements d'une personne ou les cheveux prennent feu, **SE LAISSER TOMBER ET ROULER IMMÉDIATEMENT** pour éteindre les flammes.

- Ce four est conçu pour une utilisation résidentielle seulement. Il n'est pas approuvé pour une utilisation extérieure.

### **CONCERNANT LES OISEAUX DOMESTIQUES**

Les oiseaux ont un système respiratoire sensible. Garder les oiseaux domestiques hors de la cuisine ou d'autres pièces où les émanations de la cuisine peuvent les atteindre. Pendant le mode autonettoyage, les émanations peuvent être nocives pour les oiseaux. D'autres émanations comme la margarine surchauffée et les huiles de cuisson peuvent aussi être dangereuses.

- Ne pas laisser les enfants utiliser cet appareil sans une supervision accrue d'un adulte. Enfants et animaux ne doivent pas être laissés seuls ou sans surveillance dans la zone où est installé le four. Ne jamais laisser les enfants s'asseoir ou se tenir debout sur toute pièce du four.
- Ne pas ranger des articles d'intérêt pour les enfants audessus du four. Si les enfants grimpent sur l'appareil pour atteindre ces objets, ils peuvent se blesser sérieusement.

Pour réduire le risque d'incendie dans la cavité du four :

1. Ne pas ranger des matériaux inflammables dans ou près du four.
2. Ne pas utiliser d'eau sur un feu de graisse. Éteindre le feu ou utiliser un extincteur de type à mousse ou chimique à sec.
3. Avoir un extincteur visible à proximité de l'appareil de cuisson. S'assurer de savoir s'en servir.
4. Ne pas surcuire les aliments. Surveiller le four si des matériaux combustibles, papier ou plastique sont placés dans le four.
5. Ne pas utiliser la cavité du four à des fins de rangement. Ne pas laisser d'articles en papier, ustensiles de cuisson ou d'aliments dans la cavité si non utilisée.
6. Si des matériaux à l'intérieur du four s'enflamment, laisser la porte fermer. Fermer le four et débrancher le circuit au coupe-circuit à la boîte du coupe-circuit.
7. Ne pas obstruer les ouvertures d'évent.
8. S'assurer que le ventilateur fonctionne lorsque le four est actionné. Si il ne fonctionne pas, ne pas utiliser le four. Téléphoner à un centre de service autorisé.
9. Ne jamais utiliser le four pour chauffer ou réchauffer une pièce. Ceci peut endommager les pièces du four.
10. Pour la sécurité personnelle, porter des vêtements appropriés. Des vêtements lâches, de grandes manches ne doivent jamais être portés si l'on utilise le four.

## PRÉCAUTIONS DE SÉCURITÉ

- Attacher les cheveux longs.
- Les éléments chauffants peuvent être chauds même s'ils sont de couleur foncée. Les surfaces intérieures deviennent assez chaudes pour causer des brûlures.
- Pendant et après l'utilisation, ne pas presser ni laisser des matériaux inflammables ou des vêtements entrer en contact avec les éléments chauffants ou les surfaces intérieures tant qu'ils n'ont pas suffisamment refroidis.
- La garniture sur le dessus et les côtés de la porte du four peut devenir suffisamment chaude pour causer des brûlures.
- Légèrement pour laisser la chaleur et la vapeur s'échapper avant d'enlever ou de remettre des aliments.
- Ne pas chauffer des contenants d'aliments non ouverts. L'accumulation de pression peut faire exploser le contenant et causer des blessures.
- Toujours placer les grilles à l'endroit désiré lorsque le four est froid. Si la grille doit être enlevée pendant que le four est chaud, les moufl es ne doivent pas entrer en contact avec les éléments chauffants.
- Utiliser seulement des moufl es sèches. Humides ou mouillées sur les éléments chauffants, cela peut causer des brûlures par la vapeur. Elles ne doivent pas entrer en contact avec les éléments chauffants. Ne pas utiliser une serviette ou un chiffon.



## ▶ 2. INSTALLATION ET MONTAGE

### 2.1. DÉBALLAGE

1. Coupez le plastique thermorétractile qui couvre l'emballage.
2. Retirez avec précaution tous les éléments de protection du four : couvercle supérieur, cornières latérales et base en polystyrène.

Nous vous recommandons de suivre les conseils fournis au chapitre " 6. Note écologique " relatif à la protection de l'environnement.

### 2.2. BRANCHEMENT AU RÉSEAU ÉLECTRIQUE

#### a Fours Indépendants 5HA-196 X

1. Les dimensions du meuble d'encastrement du four doivent correspondre à celles des figures, selon qu'il s'agit d'un meuble haut ou bas.

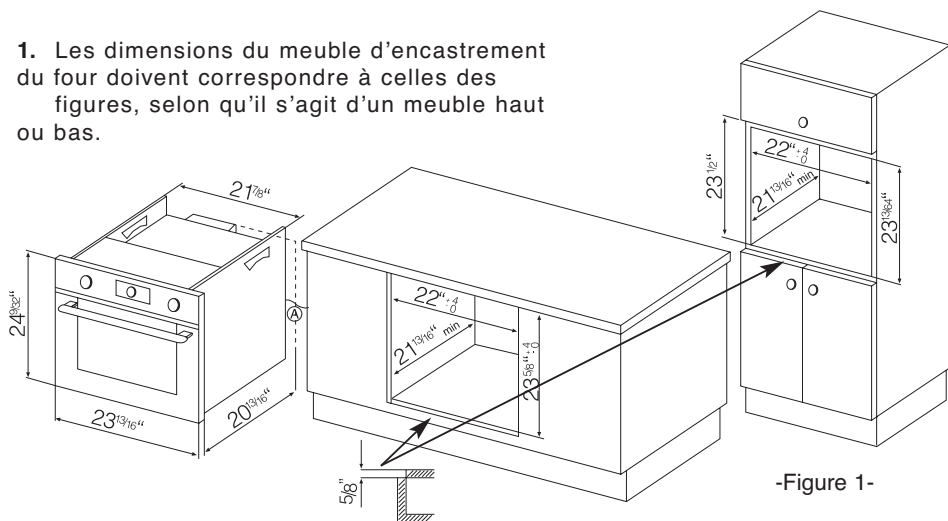

-Figure 1-

**b****Fours Indépendants 5HA-200 LX 5HA-200 RX****IMPORTANT:**

- Pour installer le four, tenir compte des dimensions de la Fig.1 ou 2.
- Une fois le four inséré dans la niche, le fixer à l'aide des boulons "A"s/figure.
- Ne pas s'appuyer sur la porte ouverte.

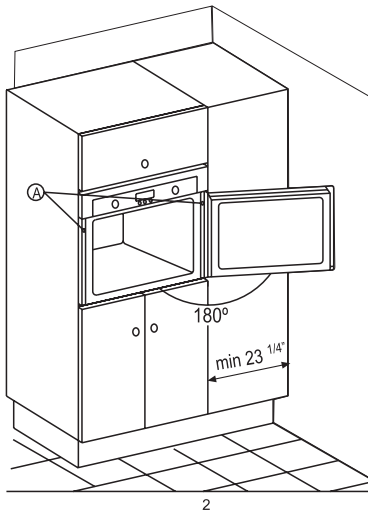
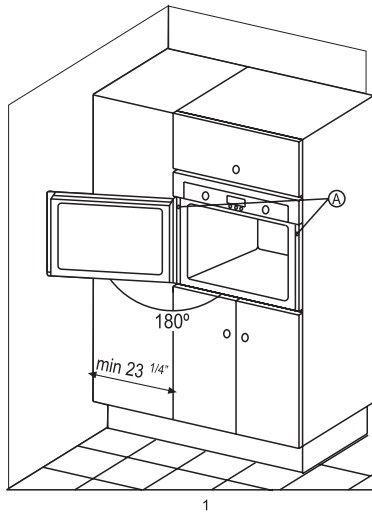

2. Dans la partie arrière du four se trouve le tuyau " A " qui permet de réaliser le branchement électrique de cette façon :

Couleur Fil Four	Couleur Fil Habitation
Noir	Noir (L1)
Blanc	Rouge (L2)
Vert/Jaune	Blanc (Neutre) et Vert/Cuivre (Terre)

**ATTENTION** : avant d'effectuer le branchement, vérifiez que :

- la tension du réseau correspond à celle indiquée sur la plaque signalétique **B**, figure 2.
- le réseau électrique auquel va être branché le four a la puissance suffisante par rapport à la puissance maximale absorbée par le four et indiquée sur la plaque signalétique.

#### DONNÉES TECHNIQUES ÉLECTRIQUES

Modèles	Volts	Watts	Ampérage
5HA-196 X 5HA-200 LX 5HA-200 RX	240	3,6 KW	15

3. Une fois branché, introduisez le four dans la niche, en prenant soin de ne pas laisser le reste du câble sur la partie supérieure du four.

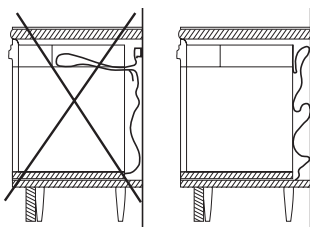

4. Un interrupteur devra être placé dans un endroit suffisamment accessible, avec un minimum de 3 mm entre les contacts.
5. Fixez le four au meuble à l'aide des 2 vis fournies dans le sac des accessoires du four.

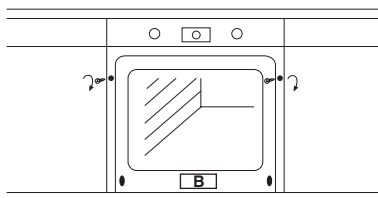

-Figure 2-

6. Si la commande de sélection des fonctions de cuisson n'est pas réglée sur " 0 ", positionnez-la sur " 0 " et mettez le four à l'heure.

## 3. UTILISATION DU FOUR ET CONSEILS PRATIQUES

### 3.1. AVANT D'UTILISER LE FOUR POUR LA PREMIÈRE FOIS

#### Réglage de l'heure

Si le programmateur de votre four intègre une horloge, nous vous recommandons de la mettre à l'heure une fois le four branché au réseau d'alimentation ou après une coupure d'électricité.

#### Nettoyage préalable

Avant la première utilisation du four, chauffez-le à vide pendant 30 minutes environ avec la porte fermée. Réglez la commande de sélection des fonctions de cuisson sur la position  et réglez la température sur 500°F. Vérifiez que vous avez retiré l'étiquetage ou le plastique de protection.

Une odeur particulière et de la fumée peuvent émaner du four. Tout cela est normal. Cette action permet d'éliminer les restes de graisse éventuels du processus de fabrication. Une fois refroidi, nettoyez le four en suivant les instructions fournies au chapitre " 4. Nettoyage et entretien du four ".

Avant d'utiliser les accessoires livrés avec le four, lavez-les à l'aide d'un chiffon légèrement savonneux.

## 3.2. DESCRIPTION GÉNÉRALE

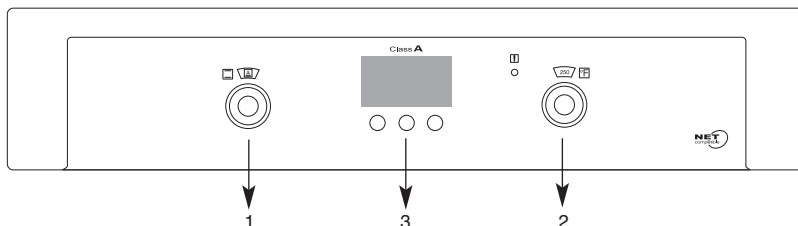

1. Commande de sélection des fonctions
2. Commande de sélection de la température
3. Programmeur

### a Commande de sélection des fonctions de cuisson





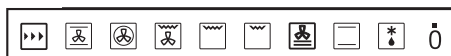



Votre four dispose de différentes fonctions de cuisson. La commande de sélection des fonctions de cuisson vous permet de sélectionner à chaque instant la fonction de cuisson la plus appropriée pour la préparation des aliments.

Si votre four dispose de commandes escamotables, vous pouvez tourner la commande de sélection des fonctions de cuisson indistinctement vers la gauche ou vers la droite. Ces commandes sont escamotables et extractibles dans n'importe quelle position d'une simple pression.



\*Nombre de fonctions différent selon modèle.

Lisez uniquement la description des fonctions dont les symboles correspondent à ceux de votre commande de sélection des fonctions de cuisson :

-  **Chaleur traditionnelle** : La chaleur émane de la partie supérieure et inférieure du four, offrant ainsi une cuisson traditionnelle.
-  **Gril doux ou Gril doux avec tournebroche** : Seule la partie centrale de la résistance du gril est connectée, ce qui permet de gratiner les plats de petite taille tout en économisant de l'énergie. Posez les aliments sur la partie centrale de la grille. (Plus tournebroche selon modèle)
-  **Gril fort** : L'action du gril couvre toute la surface du plateau permettant ainsi de gratiner des grands plats ou plusieurs préparations culinaires à la fois. Programme indiqué pour cuisiner les mêmes aliments qu'avec le gril doux mais sur toute la surface du plateau. Parfait pour tout type de gratins.
-  **Gril fort ventilé** : Programme spécial qui permet de gratiner les plats en distribuant la chaleur de façon uniforme à l'aide d'un ventilateur. Idéal pour griller de grands plats. Les viandes, par exemple, se dorment sur toute la surface.
-  **Chaleur traditionnelle ventilée** : La chaleur émane de la partie supérieure et inférieure du four, et le ventilateur distribue de manière uniforme la température. Ce programme permet de cuisiner différents plats à différents niveaux sans que les odeurs ni les saveurs se mélangent.
-  **Décongélation** : Chauffe toutes les résistances à une température très basse, ce qui permet d'obtenir la décongélation rapide et uniforme des aliments. La fonction de décongélation peut être utilisée avec n'importe quel type de produit congelé.
-  **Turbo Plus** : Le four est chauffé par la résistance circulaire située dans la partie arrière. Le ventilateur fait circuler l'air chaud à l'intérieur du four en distribuant la chaleur de façon plus uniforme. Idéal pour travailler avec différents plateaux sur plusieurs hauteurs.
-  **Pizza** : La chaleur intensive qui émane de la partie inférieure du four et le ventilateur qui distribue de manière uniforme la température permettent de réaliser des pizzas à la pâte particulièrement croustillante.
-  **Celeris** : Cette fonction est indiquée pour les plats qui requièrent le préchauffage du four. Grâce à cette fonction, le four atteint la température réglée en un temps minimum. Une fois la température atteinte, le témoin du thermostat s'éteint, indiquant que le four est prêt à passer à n'importe quelle autre fonction de cuisson.

Le témoin d'allumage général est toujours allumé lorsqu'une fonction de cuisson est sélectionnée.



## **b** Commande de sélection des températures

La commande de sélection des températures vous permet de choisir à chaque instant la température de cuisson la plus appropriée pour la préparation des aliments. La commande doit être tournée vers la droite et propose une température minimale de 100°F et maximale de 500°F.

Le témoin du thermostat s'éteint lorsque la température réglée est atteinte et s'allume et s'éteint tout au long de la cuisson pour maintenir la température.

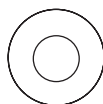
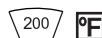

## **3.3.** FONCTIONNEMENT DU FOUR

Pour mettre votre four en marche, procédez comme suit:

1. Posez le plat à l'intérieur du four sur le plateau et au niveau recommandé (voir tables).
2. Sélectionnez une fonction de cuisson à l'aide de la commande de sélection des fonctions de cuisson (voir tables). Par exemple: 
3. Réglez la température à l'aide de la commande de sélection des températures ou bien suivez les instructions fournies dans le manuel de fonctionnement du programmeur. (voir tables). Par exemple : 400°F

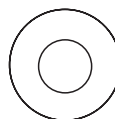
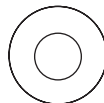
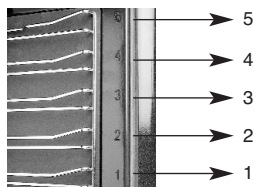

4. Utilisez le programmeur selon vos besoins, suivez les instructions fournies dans le manuel d'utilisation de celui-ci.
5. À la fin de la cuisson, n'oubliez pas de remettre la commande de sélection des fonctions sur la position " 0 " et la commande de sélection des températures sur la valeur la plus basse "■"

## 3.4. ACCESSOIRES

Le four dispose de 5 niveaux différents pour poser les accessoires. Ces niveaux apparaissent gravés à l'entrée de la cavité.. Vous pouvez, si vous le souhaitez, acquérir des accessoires supplémentaires auprès de notre Service d'assistance technique officiel.

Sont disponibles en série certains des accessoires décrits ci-dessous :

### Plateau pour pâtisserie

Plateau en aluminium idéal pour la pâtisserie.



### Plateau standard

Pour tout type d'aliments.



### Plateau profond

Le nouveau plateau profond convient pour la cuisson de plats contenant une grande quantité de sauces ou de liquides et est idéal pour la cuisson de gâteaux, d'aliments congelés et de gros morceaux de viande.





## Grille avec butoir sécurité antichute

Extractible jusqu'aux trois-quarts de son parcours, la nouvelle grille avec butoir de sécurité antichute reste stable, ce qui permet de retirer sans risques les aliments du four. De plus, elle est utilisable sur les 5 niveaux du four.

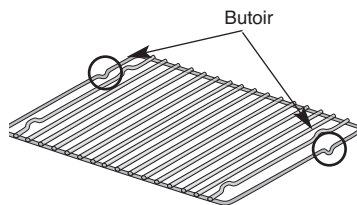

Cette grille peut recevoir tout récipient contenant des aliments à griller ou à gratiner. Elle peut également servir pour réaliser des grillades. Dans ce cas-là, nous vous recommandons de placer un plateau sous la grille pour récupérer le jus et éviter, de cette façon, de salir le four.

La grille doit être introduite dans les guides de niveau latéraux en disposant les butoirs vers le bas comme indiqué sur la figure.

## Plateau extractible. Accessibilité Totale

Grâce au nouveau "Plateau extractible. Accessibilité Totale", la manipulation des aliments est plus pratique et facile car les plateaux peuvent glisser doucement, simplifiant au maximum leur manipulation.

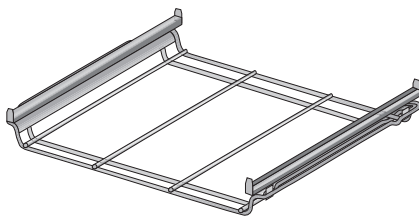

Les plateaux sont complètement extractibles, offrant une accessibilité totale. De plus, ils sont stables, ce qui vous permet de travailler et de manipuler les aliments en toute sécurité, réduisant ainsi le risque de brûlures. Vous pourrez de cette façon retirer plus facilement les aliments du four.

Ce nouveau système d'extraction totale s'adapte aux 4 niveaux inférieurs du four, ce qui multiplie les possibilités de cuisson.

### **Pour introduire les plateaux à l'intérieur du four :**

1. Introduisez le " Plateau extractible. Accessibilité Totale " dans les guides de niveau latéraux jusqu'au butoir en le levant légèrement pour sauver les butoirs. Les pivots ronds seront situés au fond.



2. Tirez au maximum les glissières télescopiques.

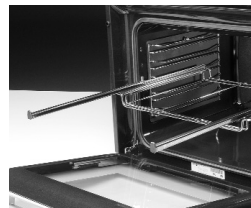

3. Coincez n'importe quel plateau entre les 4 butoirs supérieurs des glissières télescopiques.

Vous pouvez également, si vous le souhaitez, placer sur l'ensemble " Plateau extractible " et plateau, la grille avec butoirs antichute mais avec les butoirs vers le haut.



4. Faites glisser l'ensemble dans le four.



### **Pour retirer les plateaux du four :**

À la fin de la cuisson, faites glisser doucement l'ensemble vers l'extérieur, vous pourrez dès lors réaliser 2 opérations selon vos besoins :

- a. Retirer uniquement le plateau du four.
- b. Retirer l'ensemble du four. Pour cela, vous devrez lever légèrement le " Plateau extractible. Accessibilité Totale " pour sauver les butoirs qui l'empêchent de tomber.

N'oubliez pas que l'ensemble " Plateau extractible. Accessibilité Totale", plateau et/ou grille avec butoir de sécurité antichute peut être utilisé sur les 4 niveaux inférieurs.

## 3.5. CONSEILS PRATIQUES ET TABLE DE CUISSON











































### a Suggestions et conseils pratiques pour la cuisson





















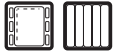



















PROBLÈME	CAUSE POSSIBLE	SOLUTION
La pâtisserie ne monte pas assez	<ul style="list-style-type: none"><li>•Sélection de fonction erronée</li><li>•Le four n'a pas été préchauffé suffisamment</li></ul>	<ul style="list-style-type: none"><li>•Vérifiez que la fonction sélectionnée correspond à celle de la table de cuisson</li><li>•Vérifiez les recommandations relatives au préchauffage fournies dans la table de cuisson</li></ul>
La pâtisserie ou les pièces rôties ne dorent pas	<ul style="list-style-type: none"><li>•Température très basse</li><li>•Matériau du moule inapproprié</li></ul>	<ul style="list-style-type: none"><li>•Vérifiez que la température sélectionnée correspond à celle de la table de cuisson, si nécessaire augmentez légèrement la température</li><li>•Utilisez uniquement des moules foncés</li></ul>
La pâtisserie ou les pièces rôties sont trop dorées	<ul style="list-style-type: none"><li>•Température trop élevée</li></ul>	<ul style="list-style-type: none"><li>•Vérifiez que la température sélectionnée correspond à celle de la table de cuisson, si nécessaire baissez-la légèrement</li></ul>
La pâtisserie ou les pièces rôties sont trop sèches	<ul style="list-style-type: none"><li>•Le temps de cuisson est trop long par rapport à la température trop basse</li></ul>	<ul style="list-style-type: none"><li>•Vérifiez que la température sélectionnée correspond à celle de la table de cuisson</li></ul>
La pâtisserie ou les pièces rôties sont trop humides	<ul style="list-style-type: none"><li>•La pâte est trop liquide</li></ul>	<ul style="list-style-type: none"><li>•Vérifiez que la température sélectionnée correspond à celle de la table de cuisson, si nécessaire augmentez-la légèrement</li><li>•Préparez une pâte moins liquide</li></ul>











































## b

## Tables de cuisson

ALIMENT	PROGRAM.	TEMPÉRATURE	TEMPS	POSITION ALIMENT	PRÉCHAUFFAGE	ACCESSOIRES
<b>VIANDES ET VOLAILLE</b>						
Veau 3,31 lb		210°C 410°F	50-60 min		Non	
Échine porc 3,31 lb		220°C 428°F	50-60 min		Non	
Poulet rôti 2,76 lb		230°C 446°F	50-60 min		Non	
Lapin rôti 2,64 lb		210°C 410°F	25-35 min		Non	
Agneau rôti 2,2 lb		220°C 428°F	40-50 min		Non	
Jambon 3,31 lb		180°C 356°F	85-95 min		Non	
Côte de porc 3,31 lb		220°C 428°F	30-40 min		Non	
Cuisses dinde pavo (2)		170°C 338°F	40-50 min		Non	
Dinde 8,8 lb		190°C 374°F	115-125 min		Non	
<b>DESSERTS</b>						
Flan		150°C 302°F	30-40 min		Non	
Gâteau		180°C 356°F	25-35 min		Oui	
Poires au vin		240°C 464°C	50-60 min		Non	
Petits gâteaux		220°C 428°F	8-12 min		Non	

ALIMENT	PROGRAM	TEMPÉRATURE	TEMPS	POSITION ALIMENT	PRÉCHAUFFAGE	ACCESSOIRES
<b>ENTRANTES Y VERDURAS</b>						
Aubergines farcies		220°C 428°F	12-16 min	 2	Oui	
Poivrons rouges grillés 2,76 lb		210°C 410°F	30-40 min	 2	Non	 
Tomates farcies (4)		220°C 428°F	15-19 min	 2	Non	
Courgettes farcies (2)		200°C 400°F	25-35 min	 1	Non	
<b>POISSONS ET FRUITS DE MER</b>						
Colin au four 3,31 lb		230°C 446°F	7-9 min	 2	Oui	
Grosses crev. au four 2,2 lb		240°C 464°F	4 min	 4	Oui	
Truites 2,2 lb		250°C 482°F	9-11 min	 3	Oui	
Thon au four		230°C 446°F	10-14 min	 3	Non	
Poissons au four 2,2 lb		220°C 428°F	13-17 min	 2	Non	
Saumon au four (4)		250°C 482°F	8-10 min	 3	Oui	
Morue au four 3,31 lb		220°C 428°C	7-9 min	 2	Oui	
<b>DIVERS</b>						
Pizza		220°C 428°F	18-22 min	 1	Oui	
Pain		220°C 428°F	18-22 min	 2	Non	
Madeleines		210°C 410°F	15-19 min	 2	Oui	

ALIMENT	PROGRAM.	TEMPÉRATURE	TEMPS	POSITION ALIMENT	PRÉCHAUFFAGE	ACCESSOIRES
<b>VIANDES ET VOLAILLE</b>						
Veau 3,31 lb		190°C 374°F	50-60 min		Non	
Échine porc 3,31 lb		200°C 392°F	50-60 min		Non	
Poulet rôti 2,76 lb		210°C 410°F	50-60 min		Non	
Lapin rôti 2,64 lb		230°C 446°F	25-35 min		Non	
Agneau rôti 2,2 lb		200°C 392°F	40-55 min		Non	
Jambon 3,31 lb		150°C 302°F	85-95 min		Non	
Côte de porc 3,31 lb		200°C 392°F	30-40 min		Non	
Cuisses dinde (2)		150°C 302°F	40-50 min		Non	
Dinde 8,8 lb		170°C 338°F	115-125 min		Non	
<b>DESSERTS</b>						
Flan		150°C 302°F	30-40min		Non	
Gâteau		180°C 356°F	15-25min		Non	
Poires au vin		220°C 428°F	50-60min		Non	
Petits gâteaux		200°C 392°F	8-12min		Non	
<b>DÉCONGÉLATION</b>						
Pour tout type d'aliments		75°C 165°F			Non	

ALIMENT	PROGRAM	TEMPÉRATURE	TEMPS	POSITION ALIMENT	PRÉCHAUFFAGE	ACCESSOIRES
<b>ENTRÉES ET LÉGUMES</b>						
Aubergines farcies		200°C 392°F	12-16 min	 2	Oui	
Poivrons rouges grillés 2,76 lb		180°C 356°F	30-40 min	 2	Non	
Tomates farcies (4)		200°C 392°F	15-19 min	 2	Non	
Courgettes farcies (2)		180°C 356°F	25-35 min	 1	Non	
<b>POISSONS ET FRUITS DE MER</b>						
Colin au four 3,31 lb		210°C 410°F	7-9 min	 2	Oui	
Grosses crev. au four 2,2 lb		220°C 428°F	4 min	 4	Oui	
Truites 2,2 lb		240°C 464°F	9-11 min	 3	Oui	
Thon au four		250°C 482°F	10-14 min	 3	Non	 
Poissons au four 2,2 lb		200°C 392°F	13-17 min	 2	Oui	
Saumon au four (4)		240°C 464°F	8-10 min	 3	Oui	
Morue au four 3,31 lb		210°C 410°C	7-9 min	 2	Oui	
<b>DIVERS</b>						
Pizza		200°C 392°F	18-22 min	 2	Non	
Pain		200°C 392°F	18-22 min	 2	Non	
Madeleines		220°C 428°F	13-17 min	 2	Oui	

## ▶ 4. NETTOYAGE ET ENTRETIEN DU FOUR

### 4.1. COMMENT NETTOYER...

#### 4.1.1. L'extérieur du four

##### **Fours avec façade en acier inoxydable:**

Nettoyez l'extérieur du four avec de préférence de l'eau tiède additionnée d'un peu de liquide vaisselle. Nous vous recommandons de rincer abondamment. Séchez immédiatement avec un chiffon doux.

Si les tâches résistent, nous vous recommandons d'utiliser des produits spécifiques pour acier inoxydable. Essayez le produit sur une petite surface avant de l'appliquer sur toute la surface. Suivez scrupuleusement les instructions du fabricant.



## 4.1.2. L'intérieur du four

Afin de conserver plus longtemps l'esthétique de votre four, nous vous conseillons de nettoyer l'intérieur du four à chaque utilisation ; vous éviterez ainsi la formation de vapeurs et de mauvaises odeurs lors des cuissons suivantes.

### a. Fours avec émail " Slide " :

Le nouvel émail " Slide " garantit une adhérence minimale des aliments sur les surfaces internes du four, ce qui facilite considérablement le nettoyage. Nettoyez l'intérieur du four lorsque celui-ci est tiède avec un peu de savon ou une solution d'eau et de vinaigre ; passez ensuite un chiffon doux propre pour sécher les parois internes.

Pour un nettoyage plus en profondeur ou si la saleté est particulièrement tenace, nous vous recommandons d'utiliser des produits nettoyants spéciaux pour fours, en suivant les instructions du fabricant. Utilisez ces produits uniquement lorsque le four est froid.

### b. Fours avec panneaux autonettoyants :

Sur les fours aux panneaux autonettoyants, la plaque arrière et les panneaux latéraux sont recouverts d'un émail autonettoyant qui élimine la graisse pendant que le four est en marche. Ces panneaux latéraux sont réversibles, ce qui permet de dupliquer la durée de vie du revêtement catalytique.



Parfois, les tâches les plus importantes ne disparaissent pas toute de suite et partent après plusieurs utilisations du four. Lorsque les éléments autonettoyants du four ne sont pas suffisamment propres, une régénération est nécessaire. Pour cela, procédez comme suit :

1. Retirez les accessoires et les récipients du four.
2. Nettoyez en profondeur les surfaces du four qui ne sont pas autonettoyantes.
3. Réglez la commande de sélection des fonctions de cuisson sur la position 
4. Réglez la température du four sur 500°C.
5. Nous vous conseillons de prolonger cette opération de 30 à 60 minutes, selon le degré de saleté des parties autonettoyantes.
6. Nettoyez les restes de sel des éléments autonettoyants avec une éponge légèrement humide.

Les éléments autonettoyants du four sont maintenant totalement fonctionnels.

**ATTENTION:** ne nettoyez jamais la plaque arrière ni les panneaux latéraux avec des produits de nettoyage spécifiques pour fours.

Si vous souhaitez nettoyer les parois latérales internes du four, vous devrez enlever d'abord les grilles et les panneaux autonettoyants situés derrière (suivez les instructions fournies au paragraphe " 4.1.4. Comment nettoyer les grilles latérales ").

Nettoyez les parois latérales de l'intérieur du four lorsqu'il est encore tiède avec de l'eau chaude et du savon ; séchez-les ensuite avec soin à l'aide d'un chiffon doux.

Pour un nettoyage plus en profondeur ou si la saleté est particulièrement tenace, nous vous recommandons d'utiliser des produits nettoyants spéciaux pour fours, en suivant les instructions du fabricant. Utilisez ces produits uniquement lorsque le four est froid.

**ATTENTION:** en aucun cas vous ne devez appliquer ce produit sur les surfaces autonettoyantes du four.

#### **Pour faciliter le nettoyage de l'intérieur du four :**

- Vous pouvez connecter la lampe. Pour cela : réglez la commande de sélection des températures sur la position " 0 " et la commande de sélection des fonctions de cuisson sur n'importe quelle fonction pour que la lampe s'allume.
- Si vous souhaitez nettoyer la tulipe en verre qui protège la lampe du four : dévissez la tulipe de la lampe et nettoyez-la de préférence avec du liquide vaisselle.



Une fois nettoyée, replacez-la sur la lampe en suivant la procédure décrite.

## Modeles 5HA-196 X

- Il est possible de retirer la porte du four facilement. Suivez scrupuleusement les étapes décrites ci-après :

Comment retirer la porte du four :

1. Ouvrez complètement la porte.

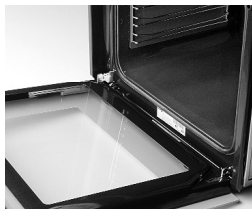

2. Soulevez le support de charnière de chaque charnière.

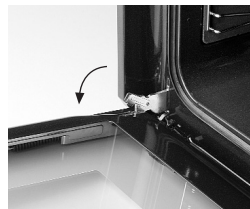

3. Fermez la porte du four doucement jusqu'à sentir un butoir, agrippez ensuite la porte des deux mains et sortez-la des fentes à charnière en tirant vers vous tout en continuant de fermer la porte. La porte est décrochée.

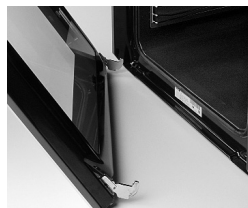

Comment monter la porte après nettoyage :

1. Glissez les charnières dans les fentes jusqu'à ce qu'elles soient accrochées, comme indiqué dans les figures.

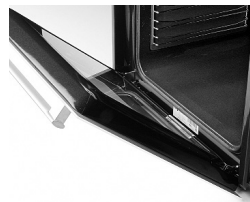

2. Ouvrez complètement la porte et baissez les supports de charnière jusqu'à ce qu'ils soient dans leur position originale. Le montage de la porte est terminé.

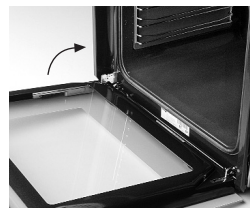

- Dans certains modèles, il est possible de rabattre le gril de la partie supérieure du four. **ATTENTION:** le four doit être froid.

Comment rabattre le gril :

1. Soulevez la tige du grill.
2. Enfoncez-là jus qu'au fond du four.



Comment remettre le gril à sa place après nettoyage :

1. Appuyez sur la baguette du gril vers le fond du four et remettez-le gril dans son support.

### 4.1.3. Les accessoires

Faites tremper les accessoires après utilisation en utilisant pour cela un produit nettoyant d'usage courant. De cette façon, les restes d'aliments s'éliminent facilement à l'aide d'une éponge ou d'une brosse souple.

### 4.1.4. Les grilles latérales

Les grilles sont extractibles pour nettoyage. Pour cela, procédez comme suit:

Comment retirer les grilles:

1. Appuyez sur la baguette supérieure de la grille vers le bas afin de la décrocher du support du panneau latéral.



- Inclinez la grille comme indiqué sur la figure et tirez-la vers l'extérieur pour l'enlever.

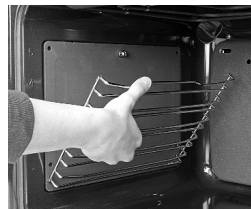

- Si votre four est autonettoyant, décrochez le panneau situé derrière la grille.

Nettoyez les grilles avec du liquide vaisselle. Pour éliminer la saleté la plus tenace, vous pouvez utiliser des éponges plus dures ou des brosses.

Comment remettre en place les grilles après nettoyage:

Insérez les grilles sur les parois latérales en suivant les étapes précédentes mais en sens inverse.

## 4.2. COMMENT REMPLACER LA LAMPE DU FOUR

En cas de panne, vous pouvez vous-même remplacer l'ampoule de la lampe qui sert à éclairer l'intérieur du four. Vous pouvez vous procurer des ampoules de rechange de 25 W et résistantes à une température de 600°F auprès du Service d'assistance technique officiel ou dans un point de vente spécialisé en électricité.. Pour changer l'ampoule procédez comme suit :





- Débranchez le four du réseau électrique. Si nécessaire, laissez le four refroidir.
- Dévissez la tulipe de la lampe en tournant vers la gauche.
- Remplacez l'ampoule par une ampoule du même type.
- Remettez la tulipe en verre sur la lampe en suivant la procédure décrite.
- Rebranchez le four au réseau électrique.



## 5. LOCALISATION ET RÉOLUTION DES PROBLÈMES

L'apparition de petites anomalies n'implique pas nécessairement l'existence de pannes, par conséquent, celles-ci ne requièrent pas l'intervention du Service d'assistance technique.

Il s'agit la plupart du temps de petites anomalies faciles à réparer. Pour éviter une intervention inutile du service technique, vérifiez si l'anomalie ou l'erreur constatée est répertoriée dans le tableau ci-dessous:

PROBLÈME	CAUSES POSSIBLES	SOLUTION
Le four NE fonctionne PAS. Les voyants sont éteints.	<ul style="list-style-type: none"> <li>•Il n'y a pas d'alimentation électrique</li> <li>•Le four n'est pas branché</li> </ul>	<ul style="list-style-type: none"> <li>•Vérifiez l'état de l'installation électrique</li> <li>•Branchez le four</li> </ul>
Le four NE fonctionne PAS	<ul style="list-style-type: none"> <li>•La commande de programmation du temps de cuisson est réglée sur la position " 0 "</li> </ul>	<ul style="list-style-type: none"> <li>•Réglez la commande sur position manuelle ou réglez le temps de cuisson souhaité</li> </ul>
Le four émet une série de signaux sonores	<ul style="list-style-type: none"> <li>•Plusieurs causes possibles</li> </ul>	<ul style="list-style-type: none"> <li>•Lisez attentivement le manuel d'utilisation du programmeur</li> </ul>
Le four NE fonctionne PAS. Le symbole  clignote	<ul style="list-style-type: none"> <li>•Le four est en marche depuis plusieurs heures et aucun bouton du temporisateur n'a été utilisé</li> <li>•Coupure d'électricité, avec la commande de sélection des fonctions hors de la position "0"</li> <li>•Four installé avec la commande de sélection des fonctions hors de la position "0"</li> </ul>	<ul style="list-style-type: none"> <li>•Réglez la commande de sélection des fonctions de cuisson sur la position "0"</li> <li>•Réglez la commande de sélection des fonctions de cuisson sur la position "0" et réglez l'heure</li> </ul>
Le four NE fonctionne PAS. Le symbole  clignote	Installation du four récente, ou coupure d'électricité, avec la commande de sélection des fonctions hors de la position "0"	Mettez l'horloge à l'heure et vous pourrez faire fonctionner le four
Le four NE fonctionne PAS. Le symbole  clignote	Le temps programmé de cuisson est terminé	Réglez les commandes de sélection des fonctions de cuisson et de température sur "0"
Le four NE fonctionne PAS. Le symbole  est allumé	Four bloqué avec commande de sélection des fonctions de cuisson sur la position "0"	Débloquez le temporisateur, selon les indications fournies au paragraphe "Blocage de sécurité pour enfants" du manuel d'utilisation du programmeur
Le four fonctionne MAIS le symbole  clignote	Le temps assigné au signal sonore du four est terminé	Appuyez sur n'importe quel bouton
La lampe du four NE fonctionne PAS	<ul style="list-style-type: none"> <li>•La lampe est hors service</li> <li>•Le four n'est pas branché ou le différentiel de son installation est hors service</li> </ul>	<ul style="list-style-type: none"> <li>•Remplacez l'ampoule</li> <li>•Branchez le four ou vérifiez le différentiel.</li> </ul>
De la fumée sort du four pendant la cuisson	<ul style="list-style-type: none"> <li>•Température du four trop élevée</li> <li>•Four gras</li> </ul>	<ul style="list-style-type: none"> <li>•Baissez la température du four</li> <li>•Nettoyez le four</li> </ul>
Le four fait du bruit après la fin de la cuisson	Le ventilateur du four fonctionne (y compris lorsque le four est éteint), pour faire baisser la température ambiante	C'est tout à fait normal
Le verre intérieur de la porte du four est embué et humide.	Un des accessoires (grille, plateau) est en contact avec le verre	Évitez le contact de l'accessoire avec le verre en l'introduisant davantage à l'intérieur du four

## ▶ 6. CONSEILS POUR ÉCONOMISER DE L'ÉNERGIE

- Préchauffez le four uniquement si la recette ou la table de cuisson l'indique.
- Utilisez de préférence des moules à pâtisserie de couleur foncée, de préférence émaillés noirs, car ces matériaux absorbent particulièrement bien la chaleur.
- Si vous souhaitez préparer plusieurs gâteaux, nous vous conseillons de le faire de façon successive. Les temps de cuisson du deuxième gâteau seront moins longs car le four est déjà chaud. Vous pouvez également préparer simultanément deux gâteaux dans des moules rectangulaires, en plaçant l'un contre l'autre.
- Si les temps de cuisson sont longs, vous pouvez arrêter le four 5 ou 10 minutes avant que le temps de cuisson prévu ne finisse, profitant ainsi de la chaleur résiduelle pour terminer de préparer le plat.
- Si votre four dispose de la fonction de cuisson " Gril doux "  , utilisez-la pour préparer des aliments au gril en petites quantités, en plaçant pour cela les aliments sur la partie centrale du plateau ou de la grille.



## ▶ 7. PROGRAMMATEUR DIGITAL DE MARCHÉ/ARRÊT

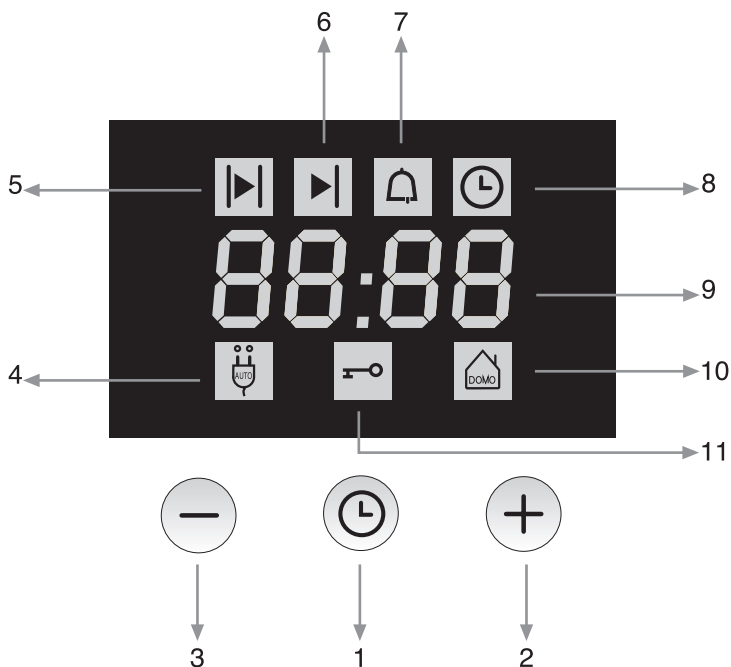

1. Bouton de sélection des fonctions du programmeur
2. Bouton "+"
3. Bouton "-" } Boutons de réglage du temps
4. Symbole de l'arrêt automatique
5. Symbole de la durée de la cuisson
6. Symbole indicateur de fin de cuisson
7. Symbole du signal sonore
8. Symbole du réglage de l'heure
9. Écran
10. Symbole indicateur de four NET Comp@tible
11. Symbole indicateur de verrouillage sécurité pour enfants

Note:Heure militar

## 7.1. HORLOGE

Si vous branchez le four au réseau électrique ou en cas de coupure d'électricité, le symbole  clignote si la commande de sélection des fonctions de cuisson est réglée sur "0". Dans le cas contraire, positionnez-la sur "0" et suivez la procédure décrite pour le réglage de l'heure.





INCORRECT





CORRECT

### Pour régler l'heure:

1. Appuyez sur le bouton . Le symbole  commence à clignoter.



2. Réglez l'heure en appuyant sur les boutons  et/ou .  
Exemple: heure actuelle 12:30.

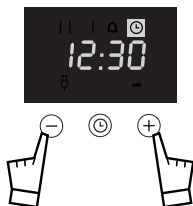

Le symbole  s'éteint au bout de quelques secondes et l'écran affiche l'heure fixée. L'appareil est prêt à être utilisé.



## 7.2. FONCTIONS DE TEMPS

**a**



### “Durée de la cuisson”

Cette fonction permet au four de s'arrêter automatiquement à la fin du temps de cuisson préalablement programmé.

#### Pour régler la durée de la cuisson:

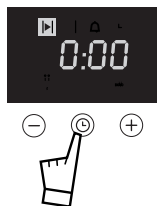

1. Sélectionnez une fonction de cuisson et réglez la température..
2. Appuyez sur le bouton . Le symbole  commence à clignoter.

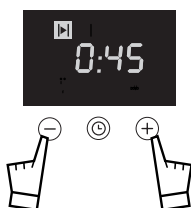

3. Réglez le temps souhaité en appuyant sur les boutons  et/ou  (10 heures maximum).  
Exemple: je souhaite programmer un temps de cuisson de 45 minutes.







Au bout de quelques secondes la fonction est activée, le four commence à fonctionner, le symbole  reste allumé et l'écran affiche les minutes qui restent avant la fin de la cuisson.

Si vous souhaitez visualiser l'heure, appuyez plusieurs fois sur le bouton  jusqu'à ce que le symbole  clignote, l'écran affiche l'heure actuelle pendant quelques secondes et affiche ensuite les minutes qui restent avant la fin de la cuisson.





À la fin du temps programmé, le four s'arrête automatiquement et commence à émettre une série de signaux sonores pendant 60 secondes alors que le symbole  clignote. Au bout des 60 secondes, le signal sonore s'arrête mais le symbole continue de clignoter. Pour que celui-ci arrête de clignoter, appuyez sur n'importe quel bouton.

Si vous souhaitez arrêter le signal sonore avant les 60 secondes, appuyez sur n'importe quel bouton. **ATTENTION:** avec cette action, le four passe automatiquement en fonctionnement manuel et continue de fonctionner. Par conséquent, si vous souhaitez arrêter la cuisson, pensez à remettre les commandes de sélection des fonctions et des températures sur "0".

### Pour modifier le temps de cuisson:

Appuyez sur le bouton . Le symbole  se met à clignoter. Changez le temps de cuisson en appuyant sur les boutons  et/ou .

### Pour annuler le temps de cuisson:



1. Appuyez sur le bouton . Le symbole  commence à clignoter.
2. Appuyez sur le bouton  jusqu'à ce que l'écran affiche "0:00". Le symbole  s'éteint au bout de quelques secondes et l'écran affiche l'heure actuelle. La fonction de temps de cuisson est annulée.

## b

### "Fin de la cuisson"



Avec cette fonction, vous pouvez régler votre four pour qu'il s'arrête automatiquement à une heure donnée. La fonction "fin de la cuisson" s'utilise simultanément avec la fonction "durée de la cuisson" pour que le four se mette en marche et s'éteigne automatiquement après avoir fonctionné le temps voulu.

### Pour régler l'heure de fin de cuisson:

1. Sélectionnez une fonction de cuisson et réglez la température.
2. Après avoir réglé la durée de la cuisson, appuyez sur le bouton . Le symbole  se met à clignoter.

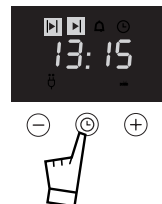

Exemple: heure actuelle 12:30, durée du temps de cuisson réglée préalablement à 45 minutes.



3. Réglez l'heure à laquelle vous souhaitez que la cuisson s'arrête en appuyant sur les boutons  et/ou .





Exemple : je veux que la cuisson finisse à 14:30. Après quelques secondes, la fonction est activée, le four commence à fonctionner selon les réglages réalisés.





Une fois que le four commence à fonctionner, l'écran affiche le temps restant pour la fin de la cuisson. Si vous souhaitez voir l'heure, appuyez plusieurs fois sur le bouton  jusqu'à ce que le symbole  clignote. L'écran affiche l'heure actuelle pendant quelques secondes et ensuite le temps de cuisson restant.

À la fin du temps programmé, le four s'arrête automatiquement et commence à émettre une série de signaux sonores pendant que le symbole  clignote. Pour l'éteindre, appuyez sur n'importe quel bouton. **ATTENTION:** avec cette action, le four passe automatiquement en fonctionnement manuel et continue de fonctionner.. Par conséquent, si vous souhaitez arrêter la cuisson, pensez à remettre les commandes de sélection des fonctions et des températures sur "0".

#### Pour modifier l'heure de fin de cuisson:

Appuyez sur le bouton . Le symbole  se met à clignoter. Réglez l'heure à laquelle vous souhaitez que la cuisson s'arrête en appuyant sur les boutons  et/ou .

#### Pour annuler l'heure de fin de cuisson:

1. Appuyez sur le bouton . Le symbole  commence à clignoter. L'écran affiche l'heure à laquelle la cuisson doit terminer.
2. Appuyez sur le bouton  jusqu'à ce que l'heure indiquée sur l'écran ne diminue plus ; il s'agira de l'heure actuelle plus le temps réglé précédemment. La fonction fin de cuisson a été annulée mais le four commence à fonctionner selon les réglages de durée de la cuisson.

## C



### "Signal sonore"

Cette fonction permet de réaliser un compte à rebours. Elle fonctionne aussi bien avec le four allumé qu'éteint car elle n'a aucune influence sur l'arrêt de l'appareil. Par conséquent, vous pourrez l'utiliser tant pour les opérations de cuisson que pour toute autre activité.

### Pour régler le signal sonore:

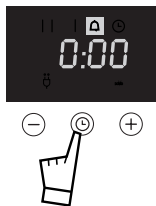
1. Appuyez plusieurs fois sur le bouton  jusqu'à ce que le symbole  clignote.



2. Réglez le temps souhaité en appuyant sur les boutons  et/ou  .  
Exemple : je souhaite être averti dans 45 minutes. Au bout de quelques secondes, la fonction est activée, le symbole  s'allume et l'écran revient à la situation antérieure.

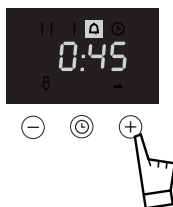





Au bout du temps programmé, le four émet une série de signaux sonores pendant 60 secondes alors que le symbole  clignote. Au bout des 60 secondes, le signal sonore s'arrête mais le symbole continue de clignoter. Pour que celui-ci arrête de clignoter, appuyez sur n'importe quel bouton.

Si vous souhaitez arrêter le signal sonore avant les 60 secondes, appuyez sur n'importe quel bouton. **ATTENTION:** si le four est en marche, n'oubliez pas que cette action n'éteint pas le four. Par conséquent, si vous souhaitez arrêter la cuisson, pensez à remettre les commandes de sélection des fonctions et des températures sur "0".

**Pour modifier le temps sélectionné dans le signal sonore**, suivez la procédure décrite pour régler le signal sonore.

### Pour annuler le signal sonore:

1. Appuyez plusieurs fois sur le bouton  jusqu'à ce que le symbole  clignote.
2. Appuyez sur le bouton  jusqu'à ce que l'écran affiche "0:00". Le symbole  s'éteint au bout de quelques secondes et l'écran revient à la situation antérieure. La fonction du signal sonore est annulée.

## d

### “Annulation des fonctions de temps”

Si vous souhaitez annuler toutes les fonctions de temps préalablement activées, appuyez pendant quelques secondes sur le bouton . Les symboles correspondant à ces fonctions s'éteindront pour indiquer qu'elles ont été désactivées.

Si le four est en marche, il continuera de fonctionner en mode manuel après annulation de ces fonctions ; si vous souhaitez l'éteindre, réglez la commande de sélection des fonctions de cuisson sur la position “0”.

**ATTENTION:** l'arrêt du four en réglant la commande de sélection des fonctions de cuisson sur la position “0” entraîne l'annulation de toutes les fonctions sauf celle de la fonction “Signal sonore” car celle-ci fonctionne aussi bien avec le four allumé qu'éteint.

## 7.3. FONCTIONS DE SÉCURITÉ

### a

#### “Arrêt automatique”

Si vous n'avez appuyé sur aucun bouton du programmateur après quelques heures de fonctionnement du four, le four s'arrête automatiquement pour des raisons de sécurité. Après l'arrêt, le four émet un signal sonore d'erreur et le symbole  commence à clignoter.



Pour désactiver l'avertissement d'arrêt automatique, réglez la commande de sélection des fonctions de cuisson sur la position “0” et le symbole  cessera de clignoter.

### b

#### “Blocage de sécurité pour les enfants”

Vous pourrez bloquer le programmateur du four pour qu'aucun enfant ne puisse le manipuler.

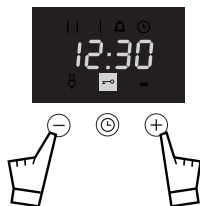

### Pour activer le blocage du programmeur:

Appuyez simultanément sur les boutons  et  pendant quelques secondes jusqu'à ce que le symbole  s'allume de façon permanente. Le programmeur du four sera alors bloqué.



Si, au moment de bloquer le programmeur, la commande de sélection des fonctions de cuisson est sur la position « 0 », le four ne peut pas se mettre en marche. Si, au contraire, le four est en cours de fonctionnement, vous pouvez modifier la fonction de cuisson choisie et régler la température, mais vous ne pouvez effectuer aucune action sur le programmeur.

### Pour débloquer le programmeur:



Appuyez simultanément sur les boutons  et  pendant quelques secondes jusqu'à ce que le symbole  s'éteigne. Toutes les fonctions du programmeur seront habilitées.



## 7.4. SIGNAUX SONORES ÉMIS PAR LE PROGRAMMATEUR



Vous avez la possibilité de désactiver les signaux sonores d'erreur, de sélection et d'acceptation émis par le programmeur. Pour cela, procédez comme suit :

### Pour désactiver les signaux sonores:

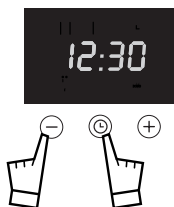
Appuyez sur le bouton  et, tout en le maintenant appuyé, appuyez sur le bouton  pendant quelques secondes. Ces signaux sont désactivés.



### Pour activer les signaux sonores :

Appuyez sur le bouton  et, tout en le maintenant appuyé, appuyez sur le bouton  pendant quelques secondes. Les signaux sonores sont de nouveau activés.

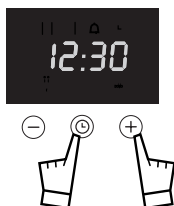



# HORNOS

## ▶ ÍNDICE

### SALUDO

<b>1. INSTRUCCIONES IMPORTANTES DE SEGURIDAD</b> . . . . .	86
<b>2. INSTALACIÓN y MONTAJE</b> . . . . .	89
2.1. Desembalado . . . . .	89
2.2. Conexión a la red eléctrica . . . . .	89
<b>3. USO DEL HORNO y CONSEJOS PRÁCTICOS</b> . . . . .	92
3.1. Antes del primer uso . . . . .	92
3.2. Descripción general . . . . .	93
3.3. Funcionamiento del horno . . . . .	95
3.4. Accesorios . . . . .	96
3.5. Consejos prácticos y tabla de cocción . . . . .	99
<b>4. LIMPIEZA y MANTENIMIENTO</b> . . . . .	104
4.1. Cómo limpiar . . . . .	104
4.1.1. El exterior del horno . . . . .	104
4.1.2. El interior del horno . . . . .	105
4.1.3. Los accesorios . . . . .	108
4.1.4. Las rejillas laterales . . . . .	108
4.2. Cómo cambiar la lámpara de su horno . . . . .	109
<b>5. LOCALIZACIÓN y SOLUCIÓN DE PROBLEMAS</b> . . . . .	110
<b>6. CONSEJOS PARA AHORRAR ENERGÍA</b> . . . . .	112
<b>7. PROGRAMADOR DIGITAL DE MARCHA-PARO</b> . . . . .	113
7.1. Reloj . . . . .	114
7.2. Funciones de Tiempo . . . . .	115
7.3. Funciones de Seguridad . . . . .	119
7.4. Señales acústicas emitidas por el programador . . . . .	121



# ▶ SALUDO

Estimado cliente,

Usted ha adquirido un **horno FAGOR** y queremos agradecerle la confianza depositada en nosotros.

**FAGOR** pone a su disposición una nueva generación de electrodomésticos que contribuyen a mejorar su calidad de vida gracias a su gama de productos innovadores, fáciles de usar y respetuosos con el medio ambiente.

La gama de productos **FAGOR** le ofrece una amplia selección de placas de cocina, campanas extractoras, microondas, lavavajillas, lavadoras y frigoríficos que podrá combinar con su nuevo horno.

Antes de emplear el horno le recomendamos que lea detenidamente los manuales de uso. En ellos usted podrá encontrar toda la información necesaria para poder utilizar al completo su nuevo **horno FAGOR**. Ponga especial atención a los consejos de seguridad y a los referidos al correcto manejo y cuidado del horno.

Al mismo tiempo, le recomendamos que conserve estos manuales ya que podrá utilizarlos en el futuro para realizar cualquier consulta que le pueda surgir. En caso de entregar el aparato a otra persona adjunte dichos manuales.

Reciba un cordial saludo como Cliente de **FAGOR**.

**FAGOR** America Inc.

# ▶ 1. INSTRUCCIONES IMPORTANTES DE SEGURIDAD

Con el uso apropiado, su nuevo horno de Fagor diseñado para ser un aparato seguro y confiable. Lea todas las instrucciones cuidadosamente antes de utilizar este aparato. Estas precauciones reducirán el riesgo de sufrir quemaduras, descargas eléctricas, fuego y lesiones. Al utilizar aparatos de cocina, se deben seguir precauciones básicas de seguridad, incluyendo las siguientes:

- Este aparato debe ser instalado y conectado a tierra correctamente por un técnico calificado. Conecte sólo a una toma de corriente con conexión a tierra. Consulte las instrucciones de preparación y conexión eléctrica en las instrucciones de instalación.
- Sólo un técnico calificado debe dar el servicio a este aparato. Contacte al centro de servicio autorizado más cercano para la inspección, reparación o ajustes.
- No repare o reemplace ninguna parte del horno a menos que fue recomendado camente. Solicite servicio en un centro de servicio autorizado.
- No opere esta unidad si no funciona bien o si fue dañada hasta que un técnico de servicio autorizado la haya revisado.
- Instale o ponga este aparato sólo de acuerdo con las instrucciones de instalación.
- Utilice este horno sólo para el uso indicado por el fabricante. Si tiene alguna pregunta, contacte al fabricante.
- No tape u obstruya ninguna abertura en este aparato.
- Use este aparato sólo para el uso indicado como se describe en este manual. No use químicos corrosivos, vapores, inflamables o productos no alimenticios en este aparato. Este tipo de horno está diseñado específicamente para calentar o cocinar alimentos. No está diseñado para uso industrial o de laboratorio. El uso de químicos corrosivos cuando calienta o limpia el horno dañará el aparato.
- En el caso de encenderse la ropa o el cabello, **ÉCHESE AL PISO Y DÉSE VUELTAS DE INMEDIATO** para apagar las llamas.

- Este horno está diseñado para uso residencial sólo. No está aprobado para el uso en exteriores.

### **CON RESPECTO A PÁJAROS**

Los pájaros tienen sistemas respiratorios muy sensibles. Mantenga los pájaros fuera de la cocina u otras habitaciones donde los puedan alcanzar los vapores de la cocina. Durante la autolimpieza, se liberan humos que pueden ser nocivos para los pájaros. Otros vapores de la cocina, como el sobrecalentar margarina y aceites para cocinar pueden ser nocivos también.

- No permita que niños utilicen este aparato a menos que estén supervisados por un adulto. Nunca se deben dejar solos a los niños y mascotas en el área donde se usa el aparato. Nunca se les debe permitir sentarse o pararse sobre ninguna parte del horno.
- No almacene cosas de interés para los niños arriba del horno. Cuando los niños se suben al aparato para alcanzar estas cosas, pueden sufrir heridas serias.

Para reducir el riesgo de un fuego dentro del horno:

1. No guarde materiales inflamables dentro o cerca del horno
2. No use agua con un incendio de grasa. Apague el fuego con un extinguidor químico de polvo o tipo espuma.
3. Tenga disponible un extinguidor de fuego apropiado, a la mano, altamente visible cerca de cualquier aparato de cocina. Sepa cómo usarlo.
4. No recueza los alimentos. Vigile el horno bien cuando utiliza cosas de papel o plástico u otros materiales combustibles dentro del horno.
5. No utilice el horno para almacenar cosas. Nunca deje productos de papel, utensilios de cocina o alimentos dentro del horno cuando no se usa.
6. En caso que se enciendan materiales dentro del horno, mantenga cerrada la puerta. Apague el horno y desconecte el circuito en la caja del cortacircuito.
7. No obstruya los ductos de ventilación del horno.
8. Asegúrese que funcione el ventilador cuando opera el horno. En caso contrario no use el horno. Llame a un centro de servicio autorizado.
9. Nunca utilice el horno para calentar una habitación. Esto puede dañar las partes del horno.
10. Use ropa apropiada por cuestión de seguridad. Nunca use prendas sueltas o los que tengan mangas largas mientras que utiliza este aparato.

## PRECAUCIONES DE SEGURIDAD

- Recoja el cabello largo.
- Los elementos de calentamiento pueden estar calientes aún si son de un color oscuro. Las superficies internas de un horno pueden estar suficientemente calientes para causar quemaduras.
- Durante y después del uso, no permita que la ropa u otros materiales inflamables tengan contacto con los elementos de calentamiento o con la superficie interna del horno hasta que se hayan enfriado.
- La moldura en la parte superior y los costados de la puerta del horno puede calentarse suficientemente para causar quemaduras.
- Tenga cuidado cuando abra la puerta del horno. Abra la puerta ligeramente para dejar escapar el aire o vapor caliente antes de sacar los alimentos.
- No caliente o recaliente contenedores de alimentos cerrados. La presión acumulada puede causar la ruptura del contenedor y causar lesiones.
- Siempre coloque las rejillas del horno en el lugar deseado cuando el horno está frío. Cuando deba mover una rejilla mientras que el horno esté caliente, evite el contacto de la agarradera de la olla con los elementos calientes.
- Siempre use agarraderas secas para las ollas. Las agarraderas mojadas o húmedas sobre superficies calientes pueden causar quemaduras por el vapor. Evite el contacto de las agarraderas con los elementos calientes. No use una toalla u otro trapo estorboso.



## 2. INSTALACIÓN Y MONTAJE

### 2.1. DESEMBALADO

1. Corte el plástico termorretráctil que cubre el embalaje.
2. Retire cuidadosamente todos los elementos de protección del horno: tapa superior, cantoneras laterales y base de poliestireno.

Le recomendamos que siga los consejos facilitados en el apartado "6. Nota Ecológica" en lo que a conservación del medio ambiente se refiere.

### 2.2. CONEXIÓN A LA RED ELÉCTRICA

#### a Hornos Independientes 5HA-196 X

1. Las medidas del mueble en el que se va a encastrar el horno han de ser las de las figuras, según sea mueble alto o bajo.

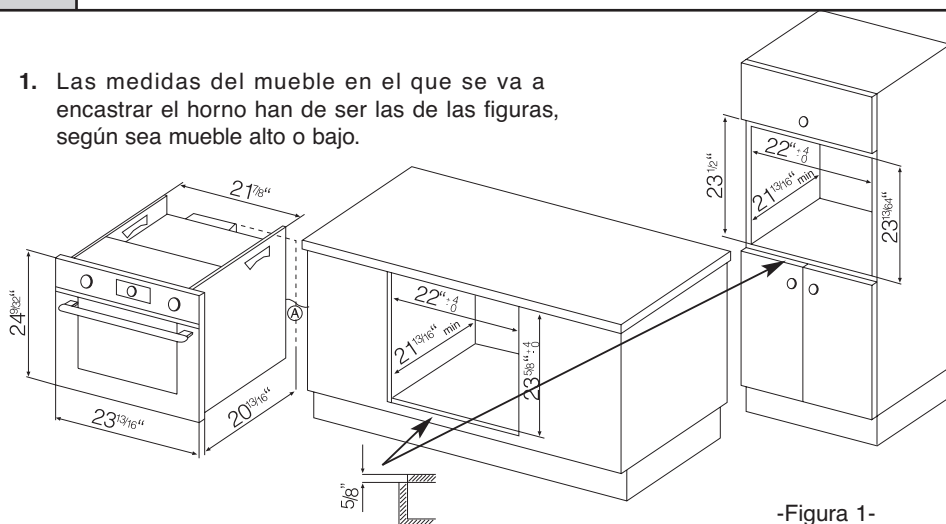

-Figura 1-

**IMPORTANTE:**

- Para instalar el horno deberá tener en cuenta las medidas de la fig.1 ó 2
- Una vez introducido el horno en el hueco, amarrar con dos tornillos "A" s/ figura.
- No colgarse de la puerta cuando está abierta.

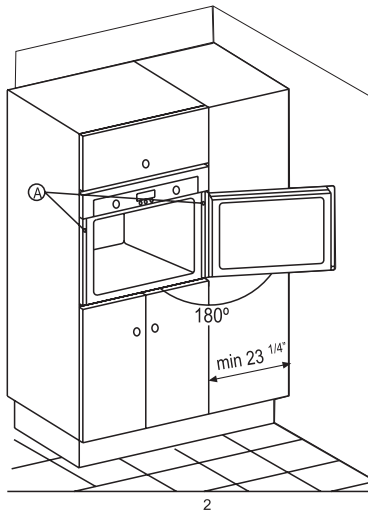
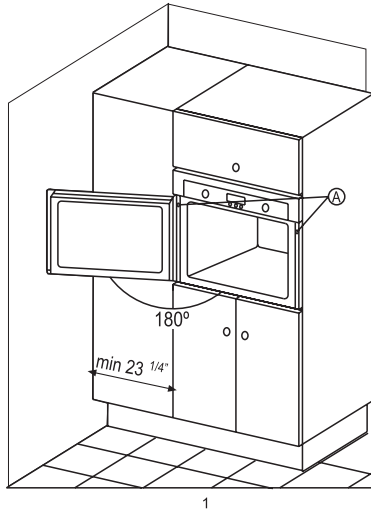

2. En la parte posterior del horno encontrará la manguera "A" a través de la cual se realiza la conexión eléctrica de la siguiente manera:

Color hilo Horno	Color hilo Vivienda
Negro	Negro (L1)
Blanco	Rojo (L2)
Verde/Amarillo	Blanco (Neutral) y Verde/Cobre (Tierra)

**ATENCIÓN:** Antes de realizar la conexión compruebe lo siguiente:

- que la tensión de la red corresponde a la indicada en la placa de características **B**, figura 2.
- que la red eléctrica a la que debe conectarse el horno tenga suficiente potencia en relación a la potencia máxima que absorbe el horno y que se indica en la placa de características.

ESPECIFICACIONES ELÉCTRICAS			
Modelo	Voltios	Wattios	Amperios
5HA-196 X 5HA-200 LX 5HA-200 RX	240	3,6 KW	15

3. Una vez enchufado, introduzca el horno en el hueco, teniendo especial cuidado de no dejar el cable sobrante en la parte superior del horno.

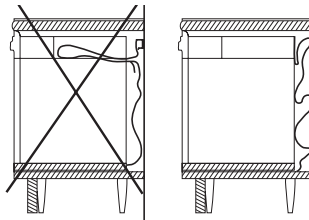

4. Se deberá colocar un interruptor para desconectar el horno en un lugar lo más accesible posible, con un mínimo de 3 mm entre contactos.
5. Sujete el horno al mueble con los 2 tornillos que encontrará en la bolsa de accesorios del horno.

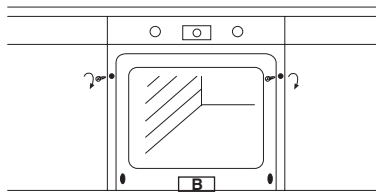

-Figura 2-

6. En caso de que el mando selector de funciones de cocinado no esté en la posición "0" sitúelo en "0" y ponga su horno en hora.

## 3. USO DEL HORNO Y CONSEJOS PRÁCTICOS

### 3.1. ANTES DEL PRIMER USO

#### Ajuste de Hora

En caso de que el programador de su nuevo horno incorpore reloj, le recomendamos que lo ponga en hora tras conectar el horno a la red eléctrica o tras un corte en el suministro eléctrico.

#### Limpieza Previa

Antes de utilizar su nuevo horno por primera vez caliéntelo en vacío durante 30 minutos aproximadamente, con la puerta cerrada. Ajuste el mando selector de funciones de cocinado en la posición  y ajuste una temperatura de 500° F. Asegúrese de haber despegado cualquier posible etiqueta o plástico protector.

Al principio puede desprender un olor particular. Así mismo, quizás constate una emanación de humo. Todo ello es normal. De esta forma eliminará del interior del horno posibles restos de grasa del proceso de fabricación. Una vez el horno se haya enfriado límpielo siguiendo las instrucciones facilitadas en el apartado “4. Limpieza y Mantenimiento”.

Antes de utilizar por primera vez los accesorios que incorpora su nuevo horno, límpielos con agua, un poco de jabón y una bayeta.

## 3.2. DESCRIPCIÓN GENERAL

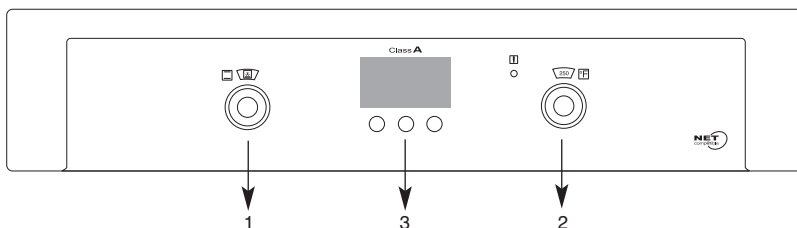

1. Mando Selector de Funciones
2. Mando Selector de Temperatura
3. Programador

### a

## Mando Selector de Funciones de Cocinado





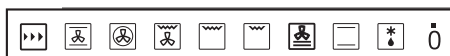



Su horno dispone de diferentes funciones de cocinado. A través del mando selector de funciones de cocinado usted podrá seleccionar en cada momento la función de cocinado más idónea para la preparación del alimento.

Si su horno dispone de mandos ocultables, el mando selector de funciones de cocinado podrá ser girado indistintamente hacia izquierda o derecha. Estos mandos se pueden ocultar y extraer en cualquier posición simplemente con la acción de pulsarlos.



\*Diferente número de funciones según modelo.

A continuación lea únicamente la descripción de aquellas funciones cuyos símbolos coincidan con los de su mando selector de funciones:

-  **Calor Tradicional:** Con esta función, el calor llega desde la parte superior e inferior, calentando al estilo de siempre.
  
-  **Grill Suave o Grill Suave con asador rotativo:** Se conecta únicamente la parte central de la resistencia del grill, permitiendo así gratinar ahorrando energía, platos de pequeño tamaño. Coloque los alimentos en la parte central de la parrilla. (Más asador rotativo según modelo)
  
-  **Grill Fuerte:** La acción del grill cubre toda la superficie de la bandeja permitiendo así gratinar grandes bandejas o diversos alimentos a la vez. Programa indicado para cocinar los mismos alimentos que con el grill suave pero abarcando toda la superficie de la bandeja. Muy apropiado para todo tipo de gratinados.
  
-  **Grill Fuerte Ventilado:** Programa especial que permite gratinar repartiendo el calor de forma uniforme con un ventilador. Ideal para realizar al grill asados de gran tamaño. De este modo los asados de carne adquieren un color dorado en toda su superficie.
  
-  **Calor Tradicional Ventilado:** El calor llega desde la parte superior e inferior del horno y el ventilador reparte uniformemente la temperatura. Pueden cocinarse al mismo tiempo diferentes platos a varios niveles sin que se mezclen sabores ni olores.
  
-  **Descongelación:** Calienta todas las resistencias a una temperatura muy baja, de esta forma se consigue una uniforme y rápida descongelación de los alimentos. La función "Descongelación" se puede realizar con cualquier tipo de alimento congelado.
  
-  **Turbo Plus:** El horno es calentado por la resistencia circular situada en la parte posterior. El ventilador hace circular el aire caliente dentro del horno repartiendo el calor más uniformemente. Ideal para trabajar con diferentes bandejas en varias alturas.
  
-  **Pizza:** El fuerte calor intensivo que llega desde la zona inferior y el ventilador que reparte uniformemente la temperatura, hacen que las pizzas adquieran una base especialmente crujiente.
  
-  **Celeris:** Indicada para aquellos platos que requieren un precalentamiento del horno. Mediante esta función el horno alcanza la temperatura ajustada en el mínimo de tiempo posible. Una vez el horno ha alcanzado la temperatura ajustada el piloto de termostato se apaga, indicando que el horno está listo para pasar a cualquier otra función de cocinado.

El **piloto indicador de encendido general** se encenderá siempre que se seleccione una función de cocinado.



## **b** Mando Selector de Temperatura

A través del mando selector de temperatura usted podrá ajustar en cada momento la temperatura de cocinado más idónea para la preparación del alimento. El mando se girará a la derecha desde 100°F hasta 500°F.

El **piloto de termostato** se apagará al alcanzar la temperatura ajustada y se encenderá y apagará a lo largo del cocinado para mantener la temperatura.

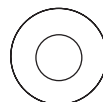

### **3.3. FUNCIONAMIENTO DEL HORNO**

Para poner su horno en marcha, debe seguir los siguientes pasos:

1. Introduzca el alimento en el horno, en la bandeja y escalón recomendado en las tablas de cocción.

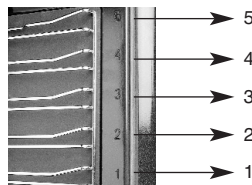

2. Seleccione una función de cocinado mediante el mando selector de funciones (ver tablas).  
Por ejemplo:

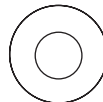

3. Ajuste una temperatura mediante el mando selector de temperatura o siguiendo las instrucciones facilitadas en el manual de funcionamiento del programador. (ver tablas).  
Por ejemplo: 400°F

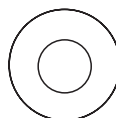

4. Utilice el programador en la forma que usted desee, siga las instrucciones facilitadas en el manual de uso del mismo.
5. Cuando finalice el cocinado, no olvide llevar el mando selector de funciones a la posición "0" y el mando selector de temperatura a la posición más baja "■".

## 3.4. ACCESORIOS

El horno posee 5 niveles distintos para colocar accesorios, estos niveles aparecerán grabados en la entrada de la cavidad. Si lo desea podrá adquirir accesorios adicionales solicitándolos en nuestro Servicio de Asistencia Técnica Oficial.

Usted dispondrá de serie de alguno de los accesorios descritos a continuación:

### Bandeja de Repostería

Bandeja de aluminio ideal para repostería.



### Bandeja Estándar

Para todo tipo de alimentos.



### Bandeja Profunda

La nueva bandeja profunda está indicada para cocinar platos con gran cantidad de salsas o líquidos, ideal para preparar pasteles jugosos, alimentos congelados y grandes piezas de asado.





## Parrilla con Topes de Seguridad Antivuelco

La nueva parrilla con tope de seguridad antivuelco se puede extraer de su alojamiento hasta aproximadamente tres cuartas partes de su recorrido sin que se vuelque.

De esta manera, usted podrá retirar con facilidad los alimentos del interior del horno. Además, le ofrece la posibilidad de usarla en cualquiera de los 5 niveles que posee el horno.

Esta parrilla puede utilizarse para soportar cualquier recipiente que contenga alimentos para asar o gratinar. Se utiliza también para realizar asados a la parrilla colocando los alimentos directamente sobre ella. En ese caso, le recomendamos que coloque una bandeja debajo de la parrilla para que recoja los jugos que desprenda la carne. De esta forma su horno se mantendrá limpio.

La parrilla se ha de introducir en las rejillas laterales con los topes hacia abajo, tal y como indica la figura.

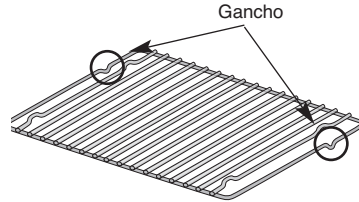

## Bandeja extraíble, Accesibilidad Total

Con la nueva "Bandeja extraíble, Accesibilidad Total" la manipulación de los alimentos resulta más cómoda y sencilla gracias a un estudiado diseño que permite que las bandejas puedan deslizarse suavemente, facilitando al máximo su manipulación.

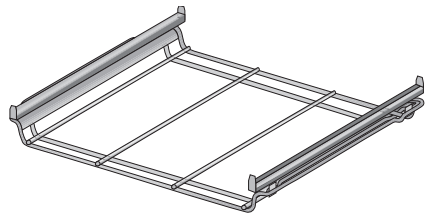

Las bandejas se pueden extraer completamente de su alojamiento, ofreciéndole una accesibilidad total. Además se mantienen totalmente estables, para que usted trabaje y manipule con total seguridad, reduciendo así el riesgo de quemaduras. De esta manera, usted podrá retirar con mayor facilidad los alimentos del interior del horno.

Este nuevo sistema de extracción total puede colocarse en cualquiera de los 4 niveles inferiores del horno, lo que multiplica aún más la posibilidad de cocinado.

### Para introducir las bandejas en el interior del horno:

1. Introduzca la “Bandeja extraíble, Accesibilidad Total” en las rejillas laterales hasta que haga tope, para ello tendrá que levantarla levemente para salvar los topes. Tenga en cuenta que al fondo irán los pivotes redondos.



2. Seguidamente extraiga al máximo las guías telescópicas.

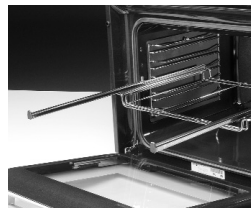

3. A continuación encaje cualquiera de las bandejas entre los 4 topes superiores de las guías telescópicas.

Si lo desea también podrá introducir sobre el conjunto de “Bandeja extraíble” y bandeja, la parrilla con topes antivuelco pero con los topes hacia arriba.



4. Introduzca por completo el conjunto en el interior del horno.



### Para extraer las bandejas del interior del horno:

Una vez finalizado el cocinado, deslice suavemente el conjunto hacia el exterior, una vez allí podrá realizar 2 operaciones según desee:

- a. Extraer únicamente la bandeja del interior del horno.
- b. Extraer todo el conjunto del interior del horno. Para ello tendrá que levantar levemente la “Bandeja extraíble” para salvar los topes que hacen que no se pueda caer.

Recuerde que el conjunto de “Bandeja extraíble”, bandeja y/o parrilla con topes de seguridad antivuelco se podrá poner en cualquiera de los 4 niveles inferiores.











































### 3.5. CONSEJOS PRÁCTICOS Y TABLA DE COCCIÓN















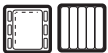

























#### a Sugerencias y Consejos prácticos para el Horneado











































PROBLEMA	POSIBLE CAUSA	SOLUCIÓN
La repostería no sube lo suficiente	<ul style="list-style-type: none"><li>•Selección de función errónea</li><li>•El horno no se ha precalentado lo suficiente</li></ul>	<ul style="list-style-type: none"><li>•Compruebe la función seleccionada con la temperatura de la tabla</li><li>•Compruebe la recomendación de precalentamiento de la tabla</li></ul>
La repostería o el asado quedan muy claros	<ul style="list-style-type: none"><li>•Temperatura muy baja</li><li>•Material de molde inadecuado</li></ul>	<ul style="list-style-type: none"><li>•Compruebe la temperatura seleccionada con la temperatura de la tabla, si es necesario aumentela ligeramente.</li><li>•Utilice únicamente moldes oscuros</li></ul>
La repostería o el asado quedan muy oscuros	<ul style="list-style-type: none"><li>•Temperatura muy alta</li></ul>	<ul style="list-style-type: none"><li>•Compruebe la temperatura seleccionada con la temperatura de la tabla, si es necesario redúzcala ligeramente</li></ul>
La repostería o el asado quedan muy secos	<ul style="list-style-type: none"><li>•El tiempo de horneado es muy largo, por haber seleccionado una temperatura muy baja</li></ul>	<ul style="list-style-type: none"><li>•Compruebe la temperatura seleccionada con la temperatura de la tabla</li></ul>
La repostería o el asado quedan muy húmedos	<ul style="list-style-type: none"><li>•Demasiado líquido en la masa</li></ul>	<ul style="list-style-type: none"><li>•Compruebe la temperatura seleccionada con la temperatura de la tabla, si es necesario aumentela ligeramente</li><li>•Prepare la masa con menos líquido</li></ul>

## b

## Tablas de Cocción

ALIMENTO	PROGRAMA	TEMPERATURA	TIEMPO	POSICIÓN ALIMENTO	PRECALENTAMIENTO	ACCESORIOS
<b>CARNES Y AVES</b>						
Ternera 3,31 lb		210°C 410°F	50-60 min	 1	No	
Lomo cerdo 3,31 lb		220°C 428°F	50-60 min	 2	No	
Pollo asado 2,76 lb		230°C 446°F	50-60 min	 1	No	
Conejo asado 2,64 lb		210°C 410°F	25-35 min	 2	No	 
Cordero asado 2,2 lb		220°C 428°F	40-50 min	 2	No	 
Pernil cerdo 3,31 lb		180°C 356°F	85-95 min	 2	No	
Costilla cerdo 3,31 lb		220°C 428°F	30-40 min	 2	No	 
Muslos pavo (2)		170°C 338°F	40-50 min	 2	No	
Pavo 8,8 lb		190°C 374°F	115-125 min	 1	No	
<b>POSTRES</b>						
Flan		150°C 302°F	30-40 min	 1	No	
Bizcocho		180°C 356°F	25-35 min	 1	Si	
Peras al vino		240°C 464°F	50-60 min	 2	No	
Pastelitos		220°C 428°F	8-12 min	 2	No	

ALIMENTO	PROGRAMA	TEMPERATURA	TIEMPO	POSICIÓN ALIMENTO	PRECALENTAMIENTO	ACCESORIOS
<b>ENTRANTES Y VERDURAS</b>						
Berenjenas rellenas		220°C 428°F	12-16 min		Si	
Pimientos rojos asados 2,76 lb		210°C 356°F	30-40 min		No	
Tomates rellenos (4)		220°C 428°F	15-19 min		No	
Calabacines rellenos (2)		200°C 392°F	25-35 min		No	
<b>PESCADOS Y MARISCOS</b>						
Merluza asada 3,31 lb		230°C 446°F	7-9 min		Si	
Langostinos al horno 2,2 lb		240°C 464°F	4 min		Si	
Truchas 2,2 lb		250°C 482°F	9-11 min		Si	
Ventresca de bonito		230°C 446°F	10-14 min		No	
Pescados asados 2,2 lb		220°C 428°F	13-17 min		No	
Salmón al horno (4)		250°C 482°F	8-10 min		Si	
Bacalao al horno 3,31 lb		220°C 428°F	7-9 min		Si	
<b>VARIOS</b>						
Pizza		220°C 428°F	18-22 min		Si	
Pan		220°C 428°F	18-22 min		No	
Magdalenas		210°C 410°F	15-19 min		Si	

ALIMENTO	PROGRAMA	TEMPERATURA	TIEMPO	POSICIÓN ALIMENTO	PRECALENTAMIENTO	ACCESORIOS
<b>CARNES Y AVES</b>						
Ternera 3,31 lb		190°C 374°F	50-60 min	 1	No	
Lomo cerdo 3,31 lb		200°C 392°F	50-60 min	 2	No	
Pollo asado 2,75 lb		210°C 410°F	50-60 min	 1	No	
Conejo asado 2,64 lb		230°C 446°F	25-35 min	 2	No	 
Cordero asado 2,2 lb		200°C 392°F	40-55 min	 2	No	
Pernil cerdo 3,31 lb		150°C 302°F	85-95 min	 2	No	
Costilla cerdo 3,31 lb		200°C 392°F	30-40 min	 2	No	
Muslos pavo (2)		150°C 302°F	40-50 min	 2	No	
Pavo 8,8 lb		170°C 338°F	115-125 min	 1	No	
<b>POSTRES</b>						
Flan		150°C 302°F	30-40min	 1	No	
Bizcocho		180°C 356°F	15-25min	 1	No	
Peras al vino		220°C 428°F	50-60min	 2	No	
Pastelitos		200°C 392°F	8-12min	 2	No	
<b>DESCONGELACIÓN</b>						
Para todo tipo de alimentos		75°C 165°F		 2	No	

ALIMENTO	PROGRAMA	TEMPERATURA	TIEMPO	POSICIÓN ALIMENTO	PRECALENTAMIENTO	ACCESORIOS
<b>ENTRANTES Y VERDURAS</b>						
Berenjenas rellenas		200°C 392°F	12-16 min		Si	
Pimientos rojos asados 2,76 lb		180°C 356°F	30-40 min		No	
Tomates rellenos (4)		200°C 392°F	15-19 min		No	
Calabacines rellenos (2)		180°C 356°F	25-35 min		No	
<b>PESCADOS Y MARISCOS</b>						
Merluza asada 3,31 lb		210°C 410°F	7-9 min		Si	
Langostinos al horno 2,2 lb		220°C 428°F	4 min		Si	
Truchas 2,2 lb		240°C 464°F	9-11 min		Si	
Ventresca de bonito		250°C 482°F	10-14 min		No	
Pescados asados 2,2 lb		200°C 392°F	13-17 min		Si	
Salmón al horno (4)		240°C 464°F	8-10 min		Si	
Bacalao al horno 3,31 lb		210°C 410°F	7-9 min		Si	
<b>VARIOS</b>						
Pizza		200°C 392°F	18-22 min		No	
Pan		200°C 392°F	18-22 min		No	
Magdalenas		220°C 428°F	13-17 min		Si	

## 4. LIMPIEZA Y MANTENIMIENTO

### 4.1. CÓMO LIMPIAR...

#### 4.1.1. El Exterior del Horno

##### **Hornos con frontal de acero inoxidable:**

Limpie el exterior del horno preferiblemente con agua tibia y un poco de lavavajillas. Se sugiere un aclarado abundante. Séquelo inmediatamente después de la limpieza con un paño suave.

Si las manchas son difíciles de eliminar le recomendamos que use productos específicos para acero inoxidable. Pruebe el producto en áreas pequeñas antes de aplicarlo a toda la superficie. Siga escrupulosamente las indicaciones del fabricante.



## 4.1.2. El Interior del Horno

Con objeto de asegurar durante largo tiempo la atractiva estética de su horno, deberá limpiar el interior del mismo, preferentemente cada vez que lo use; de esta forma evitará la generación de humos y malos olores en cocinados posteriores.

### a. Hornos con esmalte "Slide":

El nuevo esmalte "Slide" garantiza una mínima adherencia de los alimentos a las superficies del interior del horno, por ello es un esmalte de fácil limpieza. Limpie el interior del horno cuando todavía esté tibio utilizando agua caliente con un poco de jabón o una solución de agua y vinagre; tras la limpieza seque las paredes interiores cuidadosamente con un paño suave.

Para una limpieza a fondo o si la suciedad es particularmente difícil de eliminar, le recomendamos el uso de limpiadores específicos para hornos, siguiendo las instrucciones del fabricante. Utilice los limpiadores específicos para hornos sólo con el horno frío.

### b. Hornos con paneles autolimpiantes:

En los hornos con paneles autolimpiantes la placa posterior y los paneles laterales están recubiertos de un esmalte autolimpiante que elimina la grasa mientras el horno está en funcionamiento. Estos paneles laterales son reversibles, de esta forma duplican la duración de su revestimiento catalítico.



A veces, las salpicaduras más grandes no desaparecen al menos hasta que el horno se ha puesto en funcionamiento varias veces. Cuando los elementos autolimpiantes del horno no se limpien suficientemente por sí mismos será necesario regenerarlos. Para ello siga los pasos descritos a continuación:

1. Retire los accesorios y recipientes del interior del horno.
2. Limpie a fondo las superficies del horno que nos son autolimpiantes.
3. Coloque el mando selector de funciones de cocinado en la posición .
4. Ajuste la temperatura del horno a 500°F.
5. Le recomendamos que prolongue esta operación entre 30 y 60 minutos, según el grado de suciedad que presenten las partes autolimpiantes.
6. Limpie los restos de sal de los elementos autolimpiantes con una esponja ligeramente humedecida en agua.

Los elementos autolimpiantes del horno volverán a ser completamente funcionales.

**ATENCIÓN:** No limpie nunca la placa posterior ni los paneles laterales con productos de limpieza específicos para hornos.

Si desea limpiar las paredes laterales del interior del horno deberá extraer previamente las rejillas y los paneles autolimpiantes situados tras ellas (siga las instrucciones facilitadas en el subapartado “4.1.4. Cómo limpiar las rejillas laterales”).

Limpie las paredes laterales del interior del horno cuando todavía esté templado utilizando agua caliente con un poco de jabón; séquelas cuidadosamente con un paño suave.

Para una limpieza a fondo o si la suciedad es particularmente difícil de eliminar, se recomienda el uso de limpiadores específicos para hornos, siguiendo las instrucciones del fabricante. Utilice los limpiadores específicos para hornos sólo con el horno frío.

**ATENCIÓN:** En ningún caso debe aplicar este producto en las superficies autolimpiantes del horno.

#### **Para facilitar la limpieza del interior del horno:**

- Se puede conectar la lámpara de iluminación. Para ello: Sitúe el mando selector de temperatura en la posición “0” y el mando selector de funciones de cocinado en cualquier función, la luz ya estará encendida.
- Si desea limpiar la tulipa de vidrio que protege la lámpara del horno: Desenrosque la tulipa de la lámpara y límpiela preferiblemente con lavavajillas.



Tras la limpieza vuelva a colocar la tulipa en la lámpara siguiendo el procedimiento descrito.

## Modelo 5HA-196 X

- Es posible extraer la puerta del horno fácilmente. Siga escrupulosamente los pasos descritos a continuación:

Cómo extraer la puerta:

1. Abra totalmente la puerta.

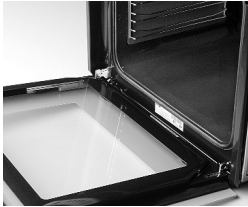

2. Suba los pestillos de las bisagras por completo.

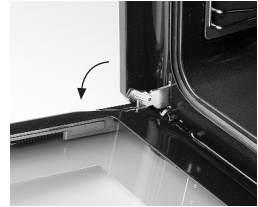

3. Cierre la puerta del horno suavemente hasta sentir un tope; una vez haya hecho tope, agarre la puerta con las 2 manos y siga cerrándola tirando de ella hacia arriba hasta extraer las bisagras de las ranuras. La puerta quedará suelta.



Cómo montar la puerta tras la limpieza:

1. Introduzca a fondo las bisagras en las ranuras hasta que queden enganchadas, tal y como indican las figuras.



2. Abra totalmente la puerta y baje los pestillos por completo hasta su posición original. La puerta estará correctamente montada.

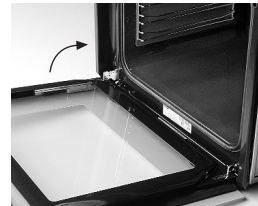

- En algunos hornos es posible abatir el grill del techo del horno. **ATENCIÓN:** el horno debe estar frío.

Cómo abatir el grill:

1. Levante la varilla del grill.

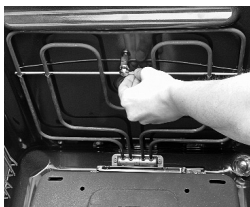

2. Presiónela hacia el fondo del horno.



Cómo volver a insertar el grill tras la limpieza:

1. Presione la varilla del grill hacia el fondo del horno y vuelva a enganchar el grill en su soporte.

### 4.1.3. Los Accesorios

Ponga los accesorios a remojo inmediatamente después de su uso, utilizando para ello un detergente de uso corriente. De este modo, los restos de alimentos adheridos pueden eliminarse fácilmente con una esponja o un cepillo suave.

### 4.1.4. Las Rejillas Laterales

Las rejillas se pueden retirar para su limpieza. Para ello siga los pasos descritos a continuación:

Cómo extraer las rejillas:

1. Presione la varilla superior de la rejilla hacia abajo hasta desengancharla del soporte del panel lateral.



2. Gire la rejilla tal y como indica la figura y tire de ella hacia fuera para extraerla.

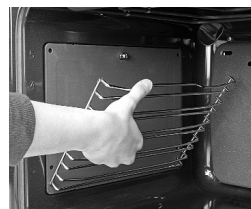

3. Si su horno es autolimpiante descuelgue el panel situado tras la rejilla.

Limpie las rejillas en el lavavajillas. Para eliminar la suciedad más resistente puede usar esponjas de limpieza más bastas o cepillos.

Cómo insertar las rejillas tras su limpieza:

Vuelva a insertar las rejillas en las paredes laterales siguiendo los pasos anteriores pero de manera inversa.

## 4.2. CÓMO CAMBIAR LA LÁMPARA DE ILUMINACIÓN DEL INTERIOR DEL HORNO

Usted mismo puede cambiar la bombilla de la lámpara de iluminación del interior del horno en caso de que esta no funcione. Podrá adquirir estas bombillas de repuesto resistentes a la temperatura hasta 600°F y de 25 W en el Servicio de Asistencia Técnica Oficial o en un comercio especializado en electricidad. Para cambiar la bombilla proceda de la siguiente forma:

1. Desconecte el horno de la red eléctrica. Si es necesario, deje que el horno se enfríe.
2. Desenrosque la tulipa de la lámpara girándola hacia la izquierda.
3. Sustituya la bombilla por una del mismo tipo.
4. Vuelva a colocar la tulipa de vidrio en la lámpara siguiendo el procedimiento descrito.
5. Vuelva a conectar el horno a la red eléctrica.













## **5. LOCALIZACIÓN Y SOLUCIÓN DE PROBLEMAS**

Hay pequeñas anomalías que no suponen necesariamente la existencia de una avería, por consiguiente, no requieren la intervención del Servicio de Asistencia Técnica.

Con frecuencia se trata de pequeñas anomalías fáciles de subsanar. Para evitar una intervención innecesaria del servicio técnico, compruebe si la avería o fallo que usted ha constatado se encuentra recogida en la siguiente tabla.

USTED ADVIERTE QUE...	POSIBLES CAUSAS	QUÉ HACER
El Horno NO funciona. Los símbolos luminosos están apagados.	<ul style="list-style-type: none"> <li>•Falta alimentación eléctrica.</li> <li>•El horno no está conectado.</li> </ul>	<ul style="list-style-type: none"> <li>•Verifique el estado de la instalación eléctrica.</li> <li>•Conecte el horno.</li> </ul>
El horno NO funciona.	<ul style="list-style-type: none"> <li>•El mando del programador está en posición "0" o </li> </ul>	<ul style="list-style-type: none"> <li>•Ponga el mando en posición manual  o ajuste el tiempo deseado de cocción.</li> </ul>
El horno emite una serie de señales acústicas.	<ul style="list-style-type: none"> <li>•Varias.</li> </ul>	<ul style="list-style-type: none"> <li>•Lea detenidamente el manual de uso del programador.</li> </ul>
El horno NO funciona. Símbolo  parpadeando.	<ul style="list-style-type: none"> <li>•Han transcurrido varias horas con el horno en funcionamiento, sin pulsar ningún botón del programador.</li> <li>•Corte en el suministro eléctrico, con el mando selector de funciones fuera de la posición "0".</li> <li>•Horno instalado con el mando selector de funciones fuera de la posición "0".</li> </ul>	<ul style="list-style-type: none"> <li>•Lleve el mando selector de funciones de cocinado a la posición "0".</li> <li>•Lleve el mando selector de funciones de cocinado a la posición "0" y ajuste la hora.</li> </ul>
El horno NO funciona. Símbolo  parpadeando.	Horno recién instalado, o corte en el suministro eléctrico, con el mando selector de funciones en la posición "0".	Ponga el reloj en hora y podrá poner el horno en marcha.
El horno NO funciona. Símbolo  parpadeando.	Ha concluido el tiempo programado de cocinado.	Lleve los mandos selectores de funciones de cocinado y de temperatura a "0".
El horno NO funciona. Símbolo  iluminado.	Horno bloqueado con mando selector de funciones de cocinado en posición "0".	Desbloquee el programador, según indica el apartado "Bloqueo de seguridad para niños" del manual de uso del programador.
El horno SÍ funciona, pero símbolo  parpadeando.	Ha transcurrido el tiempo asignado al avisador del horno.	Pulse cualquier botón.
La lámpara del horno NO funciona.	<ul style="list-style-type: none"> <li>•La lámpara está fuera de servicio.</li> <li>•El horno no está conectado o el diferencial de su instalación está fuera de servicio.</li> </ul>	<ul style="list-style-type: none"> <li>•Cambie la bombilla.</li> <li>•Conecte el horno o verifique el diferencial.</li> </ul>
Sale humo durante la cocción.	<ul style="list-style-type: none"> <li>•Temperatura del horno demasiado elevada.</li> <li>•Horno grasiento.</li> </ul>	<ul style="list-style-type: none"> <li>•Reduzca la temperatura del horno.</li> <li>•Limpie el horno.</li> </ul>
El horno hace ruido después de finalizar la cocción.	El ventilador del horno funciona (incluso con el horno apagado), para reducir la temperatura del entorno.	Es absolutamente normal.
El vidrio interior de la puerta del horno está empañado y gotea.	Algún accesorio (rejilla, bandeja) en contacto con el vidrio.	Introduzca el accesorio más al interior evitando el contacto con el vidrio.

## ▶ 6. CONSEJOS PARA AHORRAR ENERGÍA

- Precaliente el horno sólo en caso de que se indique en la receta o en la tabla de cocción del plato a cocinar.
- Utilice preferentemente moldes de repostería de color oscuro, preferiblemente esmaltados de negro, dado que estos materiales absorben particularmente bien el calor.
- En caso de querer preparar varios pasteles, se aconseja hacerlo de forma sucesiva. Al estar el horno caliente, se reducen los tiempos de horneado del segundo pastel. También se pueden preparar simultáneamente dos pasteles en moldes rectangulares, colocándolos uno junto al otro.
- En caso de largos periodos de horneado, puede desconectar el horno 5 o 10 minutos antes de transcurrir el tiempo de horneado previsto, aprovechando de este modo el calor residual para terminar de preparar el alimento.
- Si su horno dispone de la función de cocinado “Grill suave”  , utilícela para preparar alimentos al grill en pequeñas cantidades, colocando para ello los alimentos en la parte central de la bandeja o parrilla.



## 7. PROGRAMADOR DIGITAL DE MARCHA-PARO

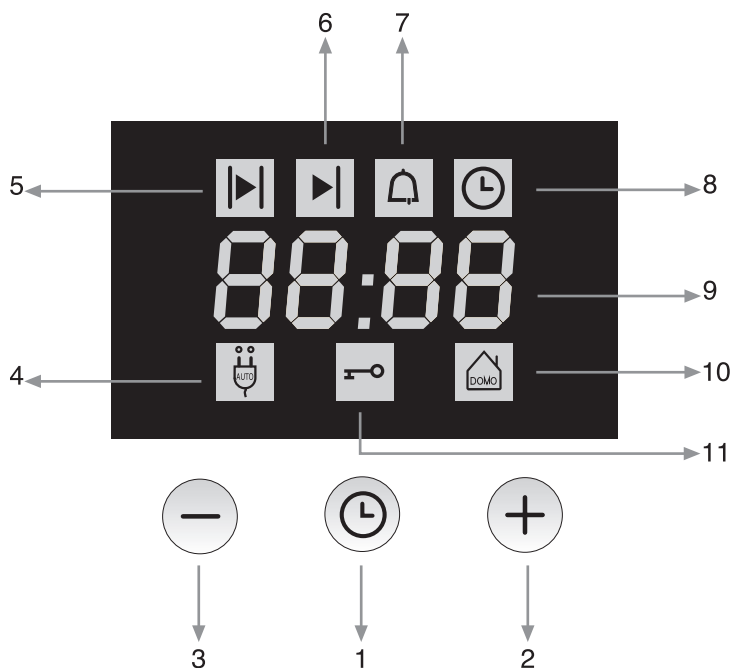

1. Botón selector de funciones del programador
2. Botón "+"
3. Botón "-" } Botones de ajuste del tiempo
4. Símbolo indicador de desconexión automática
5. Símbolo indicador de la duración del cocinado
6. Símbolo indicador de la hora de finalización del cocinado
7. Símbolo indicador del avisador
8. Símbolo indicador de ajuste de hora
9. La pantalla
10. Símbolo indicador de horno NET Comp@tible
11. Símbolo indicador de bloqueo de seguridad para niños

Nota: Hora militar

## 7.2. RELOJ

Al conectar el horno a la red eléctrica o tras un corte en el suministro eléctrico, parpadeará el símbolo , **siempre que el mando selector de funciones de cocinado esté en posición "0"**; Si no es así, llévelo a "0" y siga el procedimiento descrito para ajustar la hora.





INCORRECTO





CORRECTO

### Para ajustar la hora:

1. Pulse el botón  y comenzará a parpadear el símbolo .



2. Ajuste la hora pulsando los botones  y/o  .  
Ejemplo: Hora actual 12:30.

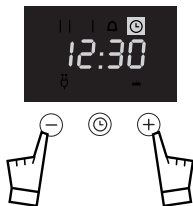

Después de unos segundos el símbolo  se apagará y la pantalla mostrará la hora fijada. El aparato estará listo para utilizar.



## 7.3. FUNCIONES DE TIEMPO

**a**



### “Duración del Cocinado”

Mediante esta función, el horno se desconecta automáticamente al finalizar el tiempo de cocción previamente programado.

**Para ajustar la duración del cocinado:**

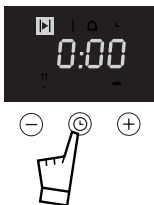

1. Seleccione una función de cocinado y ajuste una temperatura.
2. Pulse el botón  y comenzará a parpadear el símbolo .

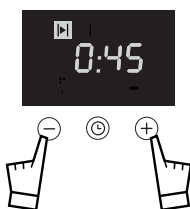

3. Ajuste el tiempo deseado pulsando los botones  y/o  (máximo 10 horas).  
Ejemplo: Deseo programar una duración de cocinado de 45 minutos.



Después de unos segundos la función se activará, el horno empezará a funcionar, el símbolo  quedará iluminado de forma fija y la pantalla pasará a mostrar los minutos que restan para que finalice el cocinado.

En caso de querer **visualizar la hora** pulse repetidas veces el botón  hasta que parpadee el símbolo , la pantalla mostrará la hora actual durante unos segundos y una vez finalizado ese tiempo volverá a mostrar los minutos que restan para que finalice el cocinado.





Al concluir el tiempo programado el horno se desconectará automáticamente y comenzará a emitir una serie de señales acústicas durante 60 segundos mientras parpadea el símbolo . Una vez finalizado ese tiempo el horno dejará de sonar pero el símbolo continuará parpadeando. Para que deje de parpadear pulse cualquier botón.

Si desea **silenciar** la señal acústica antes de los 60 segundos pulse cualquier botón. **ATENCIÓN:** al realizar esta operación, el horno pasará de forma automática a funcionamiento manual y **continuará funcionando**. Por lo tanto, si desea finalizar el cocinado no olvide llevar los mandos selector de funciones y selector de temperatura a la posición "0".

#### Para modificar la duración de cocinado:

Pulse el botón  y comenzará a parpadear el símbolo . Modifique la duración del cocinado pulsando los botones  y/o .

#### Para anular la duración de cocinado:



1. Pulse el botón  y comenzará a parpadear el símbolo .
2. Pulse el botón  hasta que el tiempo indicado en la pantalla sea "0:00". Después de unos segundos el símbolo  se apagará y la pantalla pasará a mostrar la hora actual. La función "Duración del cocinado" habrá sido anulada.

## b

### "Finalización del Cocinado"



Mediante esta función, usted puede ajustar su horno para que se desconecte automáticamente a una hora determinada. La función "Finalización del cocinado" se utiliza simultáneamente con la función "Duración del cocinado" para que el horno se conecte y desconecte automáticamente tras haber estado funcionando el tiempo deseado.

#### Para ajustar la hora de finalización del cocinado:

1. Seleccione una función de cocinado y ajuste una temperatura.
2. Previamente ajustada la duración del cocinado, pulse el botón  y el símbolo  comenzará a parpadear.

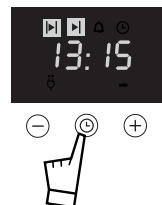
Ejemplo: Hora actual 12:30, duración de cocinado previamente ajustada 45 minutos.





3. Ajuste la hora a la que desea que finalice el cocinado pulsando los botones  y/o .

Ejemplo: Deseo que el cocinado esté listo para las 14:30.





Después de unos segundos la función se activará, el horno comenzará a funcionar de acuerdo con los ajustes realizados.





Una vez el horno haya comenzado a funcionar la pantalla mostrará el tiempo que resta para que finalice el cocinado, si desea **visualizar la hora** pulse repetidas veces el botón  hasta que parpadee el símbolo , la pantalla mostrará la hora actual durante unos segundos y una vez finalizado ese tiempo volverá a mostrar los minutos que restan para que finalice el cocinado.

Al concluir el tiempo programado el horno se desconectará automáticamente y se oír una señal acústica mientras el símbolo  comienza a parpadear. **Para silenciarlo** pulse cualquier botón; **ATENCIÓN:** al realizar esta operación, el horno pasará de forma automática a funcionamiento manual y **continuará funcionando**. Por lo tanto, si desea finalizar el cocinado no olvide llevar los mandos selector de funciones y selector de temperaturas a la posición "0".

#### Para modificar la hora de finalización del cocinado:

Pulse el botón  hasta que comience a parpadear el símbolo . La pantalla mostrará la hora a la que debe finalizar el cocinado, modifíquela pulsando los botones  y/o .

#### Para anular la hora de finalización del cocinado:

1. Pulse el botón  hasta que comience a parpadear el símbolo . La pantalla mostrará la hora en la que debe finalizar el cocinado.
2. Pulse el botón  hasta que la hora indicada en la pantalla no disminuya más, esta será la hora actual más el tiempo de duración ajustado con anterioridad. La función finalización de cocinado habrá sido anulada pero el horno comenzará a funcionar de acuerdo con los ajustes de la duración de cocinado.

## C

### “Avisador”

El avisador que incorpora el horno permite realizar una cuenta atrás. Funciona tanto con el horno encendido como apagado, ya que no tiene ninguna influencia sobre la desconexión del aparato. De esta forma usted podrá utilizarlo tanto para las operaciones del horno como para cualquier otro asunto.

## Para ajustar el avisador:

1. Pulse repetidas veces el botón  hasta que parpadee el símbolo .

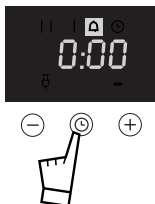

2. Ajuste el tiempo deseado pulsando los botones  y/o .

Ejemplo: Deseo que me avise dentro de 45 minutos.

Después de unos segundos la función se activará, el símbolo  quedará iluminado de forma fija y la pantalla pasará a su situación anterior.

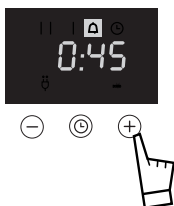





Transcurrido el periodo de tiempo ajustado, el horno emitirá una serie de señales acústicas durante 60 segundos mientras el símbolo  parpadea. Una vez finalizado ese tiempo el horno dejará de sonar pero el símbolo continuará parpadeando. Para que deje de parpadear pulse cualquier botón.

Si desea **silenciar** la señal acústica antes de los 60 segundos pulse cualquier botón. **ATENCIÓN:** En caso de que el horno estuviese en funcionamiento, recuerde que el avisador **no corta el funcionamiento del horno**. Por lo tanto, si desea finalizar el cocinado no olvide llevar los mandos selector de funciones y selector de temperaturas a la posición "0".

**Para modificar el tiempo seleccionado en el avisador**, siga el procedimiento descrito para ajustar el avisador.

## Para anular el avisador:

1. Pulse repetidas veces el botón  hasta que parpadee el símbolo .
2. Pulse el botón  hasta que el tiempo indicado en la pantalla sea "0:00". Después de unos segundos el símbolo  se apagará y la pantalla pasará a su situación anterior. La función del avisador habrá sido anulada.

**d****“Anulación de las Funciones de Tiempo”**

Si desea anular todas las funciones de tiempo previamente activadas, mantenga pulsado durante unos segundos el botón . Los símbolos correspondientes a dichas funciones se apagarán indicando que han sido desactivadas.

En caso de que el horno estuviera en funcionamiento, después de anular dichas funciones continuará funcionando de forma manual; si desea apagarlo lleve el mando selector de funciones de cocinado a la posición “0”.

**ATENCIÓN:** Apagar el horno llevando el mando selector de funciones de cocinado a la posición “0” conlleva la anulación de todas las funciones de tiempo excepto la función “Avisador” ya que ésta funciona tanto con el horno encendido como apagado.

**7.3. FUNCIONES DE SEGURIDAD****a****“Desconexión Automática”**

Si durante varias horas con el horno en funcionamiento usted no ha pulsado ningún botón del programador, por razones de seguridad el horno se desconectará de forma automática. Tras la desconexión el horno emitirá una señal acústica de error y el símbolo  comenzará a parpadear.

Para desactivar la indicación de desconexión automática lleve el mando selector de funciones de cocinado a la posición “0” y el símbolo  dejará de parpadear.

**b****“Bloqueo de Seguridad para niños”**

Usted podrá bloquear el programador del horno para que no pueda ser manipulado por niños.

### Para activar el bloqueo del programador:

Mantenga pulsados simultáneamente los botones **+** y **-** durante unos segundos hasta que el símbolo  quede iluminado de forma fija. El programador del horno habrá sido bloqueado.

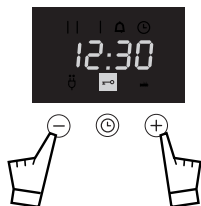

Si en el momento de bloquear el programador el mando selector de funciones de cocinado estaba en posición "0", tras el bloqueo el horno no se podrá poner en marcha. Si por el contrario el horno estaba en funcionamiento usted podrá modificar la función de cocinado seleccionada y ajustar la temperatura pero no podrá realizar ninguna actuación sobre el programador.

### Para desbloquear el programador:



Mantenga pulsados simultáneamente los botones **-** y **+** durante unos segundos hasta que el símbolo  se apague. Todas las funciones del programador estarán habilitadas.



## 7.4. SEÑALES ACÚSTICAS EMITIDAS POR EL PROGRAMADOR



Usted tiene la posibilidad de desactivar las señales acústicas de error, selección y aceptación emitidas por el programador. Para ello proceda del siguiente modo:

### Para desactivar las señales acústicas:

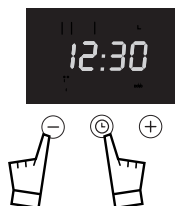
Pulse el botón  y manteniéndolo pulsado, pulse el botón  durante unos segundos. Dichas señales habrán sido desactivadas.



### Para activar las señales acústicas:

Pulse el botón  y manteniéndolo pulsado, pulse el botón  durante unos segundos. Las señales habrán sido nuevamente activadas.

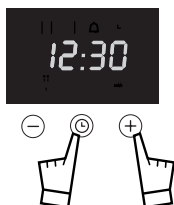



**FAGOR AMERICA, INC.**

**PO BOX 94**

**LYNDHURST, NJ 07071**

**Toll Free: 1.800.207.0806**

**Email: [infoappliances@fagoramerica.com](mailto:infoappliances@fagoramerica.com)**

**[www.fagoramerica.com](http://www.fagoramerica.com)**

**The manufacturer reserves the right to modify the items described in this manual.**

**Le producteur se réserve le droit de modifier les articles décrits dans cette guide.**

**El fabricante se reserva el derecho de modificar los productos descritos en este manual.**

## Free Manuals Download Website

<http://myh66.com>

<http://usermanuals.us>

<http://www.somanuals.com>

<http://www.4manuals.cc>

<http://www.manual-lib.com>

<http://www.404manual.com>

<http://www.luxmanual.com>

<http://aubethermostatmanual.com>

Golf course search by state

<http://golfingnear.com>

Email search by domain

<http://emailbydomain.com>

Auto manuals search

<http://auto.somanuals.com>

TV manuals search

<http://tv.somanuals.com>