

**FANTOM®**

# Programmable Air Purifier

**OWNER'S MANUAL**

**Model AP500H**

120V., 60Hz, 108 Watts



**FANTOM**

94 Main Mill Street, Door 16  
Plattsburgh, NY 12901  
Tel.: 1 (800) 275-9251



Model  
AP500H



## ONE (1) YEAR LIMITED WARRANTY

**Fantom** warrants this product to be free from defects in material and workmanship for a period of one (1) year from the date of the original purchase. This warranty applies only to normal domestic household use.

Should your appliance fail to operate properly while in use under normal household conditions within the warranty period, return the complete appliance, freight prepaid to:

**Fantom**, 94 Main Mill Street, Plattsburgh, N.Y., 12901

If the appliance is found to be defective in material or workmanship, **Fantom** will repair or replace it free of charge. Proof of purchase date must be included. \*

Non-durable parts including, without limitation, filters, uv lights, and electrical parts which normally require replacement are specifically excluded from warranty.

The liability of **Fantom** is limited solely to the cost of the repair or replacement of the unit at our option. This warranty does not cover normal wear of parts and does not apply to any unit that has been tampered with. This limited warranty does not cover damage caused by misuse, abuse, negligent handling or damage due to faulty packaging or mishandling in transit. This warranty does not cover damage or defects caused by or resulting from damages from shipping or repairs, service or alterations to the product or any of its parts, which have been performed by a repair person not authorized by **Fantom**.

This warranty is extended to the original purchaser of the unit and excludes all other legal and/or conventional warranties. The responsibility of **Fantom** if any, is limited to the specific obligations expressly assumed by it under the terms of the limited warranty. **In no event is Fantom** liable for incidental or consequential damages of any nature whatsoever. Some states or provinces do not permit the exclusion or limitation of incidental or consequential damages, so the above may not apply to you.

This warranty gives you specific legal rights, and you may also have other rights which vary from state to state or province to province.

**\*Important: Carefully pack item to avoid damage in shipping. Be sure to include proof of purchase date and to attach tag to item before packing with your name, complete address and phone number with a note giving purchase information, model number and what you believe is the problem with item. We recommend you insure the package (as damage in shipping is not covered by your warranty). Mark the outside of your package "ATTENTION CUSTOMER SERVICE". We are constantly striving to improve our products, therefore the specifications contained herein are subject to change without notice.**



## OWNERSHIP REGISTRATION CARD

Please fill out and mail the product registration card within ten (10) days of purchase. The registration will enable us to contact you in the unlikely event of a product safety notification. By returning this card you acknowledge to have read and understood the instructions for use, and warnings set forth in the accompanying instructions.

**Fantom**, 94 Main Mill Street, Door 16, Plattsburgh, NY., 12901

Model AP500H

Appliance model

Date purchased

Name of store

Owner's name

Address

City

State

Zip Code

# IMPORTANT SAFETY INSTRUCTIONS

When using electrical appliances, basic safety precautions should always be followed, including the following:

1. **Read all instructions before using.**
2. To protect against fire, electric shock and personal injury, do not immerse appliance, its cord or plug, in water or other liquid.
3. Close supervision is necessary when any appliance is used near children.
4. Unplug from outlet when not in use, before putting on or taking off parts and before cleaning or changing filter.
5. Avoid contact with moving parts.
6. **Do not** operate any appliance with a damaged cord or plug or after the appliance malfunctions or is dropped or damaged in any manner. Return appliance to **Fantom** for examination, repair or electrical or mechanical adjustment.
7. The use of accessory attachments not recommended by the appliance manufacturer may result in fire, electrical shock or personal injury.
8. **Do not** use outdoors.
9. Keep the cord out of heavy traffic areas. To avoid fire hazard, NEVER put the cord under rugs, near heat registers, radiators, stoves, or heaters.
10. To disconnect, turn the unit "OFF" and unplug from wall outlet.
11. **Never** drop or insert any object into any openings.
12. **Never** block the air openings, or place on soft surface, such as a bed or sofa, this could cause the unit to tip over, and block air flow.
13. **Do not** place your face directly on the outlet grill or look into the ultraviolet light. Direct UV light exposure to eyes can cause temporary or chronic adverse effect to your eyesight.
14. **Do not** operate this product in any greasy environment such as in the kitchen. This product is not intended to filter oil or grease from the air.
15. **Do not** operate this unit in a wet environment such as a bathroom or damp basement this could cause electric shock.
16. **Do not** operate this product in a garage or other area with oil or chemicals such as solvents or insecticides may be present.
17. **Do not** operate this appliance without the outlet grill or filter in place or if the outlet grill is broken or damaged.
18. This air purifier is equipped with safety interlock switches that turn the unit off if the intake or outlet grills are removed. **Do not** attempt to defeat or override this safety feature.
19. Be sure that the voltage indicated on the name plate matches with your home's voltage.
20. **Never** clean with scouring powders or hard implements, this may damage the unit. Use a soft damp cloth to clean the exterior of the unit.

# SAVE THESE INSTRUCTIONS FOR HOUSEHOLD USE ONLY

This appliance is for **HOUSEHOLD USE ONLY**. No user-serviceable parts inside. Power unit never needs lubrication. **Do not** attempt to service this product. **Do not** immerse the power unit in water or other liquid. An extension cord may be used with care; however the marked electrical rating should be at least as great as the electrical rating of the appliance. The extension cord should not be allowed to drape over the counter or tabletop where it can be pulled on by children or tripped over.



### POLARIZED PLUG

**WARNING:** To reduce the risk of electric shock, this appliance has a polarized plug (one blade is wider than the other). This plug will fit in a polarized outlet only one way. If the plug does not fit fully in the outlet, reverse the plug. If it still does not fit, contact a qualified electrician to install the proper outlet. Do not modify the plug in any way.

## PRECAUTIONARY MEASURES

**Important:** If the unit is not properly placed in a room it can interfere with performance of the unit or other appliances in the home. Follow these placement safe guards for optimum performance.

1. The unit must be placed at least 6 feet away from a TV set, radio or cordless phone.

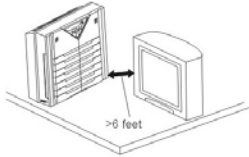

2. Do not blow air directly into the air purifier.

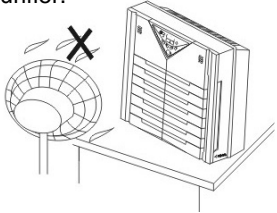

3. Keep sides of the unit more than 4 inches away from walls.

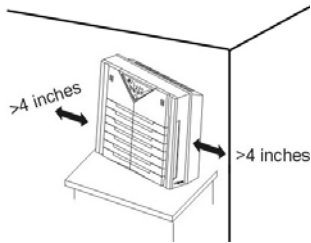

4. When pulling out the power plug from the wall outlet, pull the plug not the power cord.



5. Avoid direct sunlight on the unit. This could interfere with the signals from the remote control operation.

6. **Do not** place the unit where the air intake or outlet grill could be obstructed by curtains or drapery. Curtains, doors, or furniture could interfere with the radio signals from the remote control.

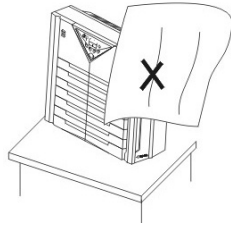

7. Place the air purifier in a well ventilated location of the room.

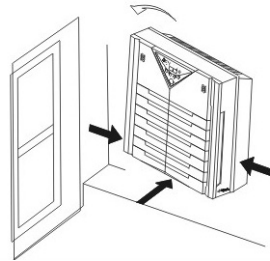

8. Placing the air purifier close to the source of the air pollution can improve the overall air quality of the room more quickly.

9. If there are lamps with remote control operation, the remote control for the air purifier may not function properly.

# FANTOM®

## TO ORDER REPLACEMENT FILTERS AND BULBS for Model AP500H

Filter Replacement Item # XAP500H

Bulb Replacement Item # 102AMI

Call: 1 (800) 275-9251

Monday to Friday 8:30 A.M. - 5:00 P.M. Eastern Standard Time

## FOR TECHNICAL SUPPORT for Model AP500H

Call: 1 (800) 275-9251

Monday to Friday 8:30 A.M. - 5:00 P.M. Eastern Standard Time

### Please Note:

The pre-filter is washable. It should however be replaced every six (6) months to ensure peak performance of your air purifier. The HEPA filter should be replaced every six (6) to nine (9) months of usage depending on household environments. Some discoloration of the HEPA filter material may occur, this is normal and will not affect the filter's performance.

It is important that when you wash the pre-filter, you allow it to air dry **COMPLETELY** before using again. We recommend 24 hours to air dry. **DO NOT DRY FILTER IN DRYER.**

### Important:

Make sure that **THE PRE-FILTER** is **completely** dry before inserting back onto the HEPA filter.

## TROUBLESHOOTING

This appliance was inspected thoroughly and was in good operating condition when it was shipped from the factory. If a minor problem occurs, it usually can be solved quite easily when the cause is found. Therefore, this checklist is provided for your convenience.

PROBLEM	POSSIBLE CAUSE	POSSIBLE SOLUTION
Unit will not operate	<ol style="list-style-type: none"> <li>1. "On/Off" power button has not been pressed.</li> <li>2. Unit is not plugged in.</li> <li>3. The air intake grill has not been installed and locked into place.</li> </ol>	<ol style="list-style-type: none"> <li>1. Press the "On/Off" power button.</li> <li>2. Check to make sure the unit is plugged in.</li> <li>3. Check to make sure the filters are properly installed and the air intake grill is installed and locked into place.</li> </ol>
Reduced air flow or poor filtering	<ol style="list-style-type: none"> <li>1. The air intake or air outlet grill may be blocked.</li> <li>2. The HEPA filter may be clogged.</li> </ol>	<ol style="list-style-type: none"> <li>1. Make sure nothing is in front of or on top of the unit.</li> <li>2. Check the HEPA filter indicator light. Replace the HEPA filter if this indicator is lit.</li> </ol>
The filter indicator is lit after the filter has been replaced.	<ol style="list-style-type: none"> <li>1. The unit has not been reset.</li> </ol>	<ol style="list-style-type: none"> <li>1. Turn on the machine, then press and hold the TIMER control button until the filter indicator is off.</li> </ol>
The power light indicator lamp flickers quickly (5 times per second).	<ol style="list-style-type: none"> <li>1. The unit needs to be reset.</li> </ol>	<ol style="list-style-type: none"> <li>1. Unplug the unit and reinsert the plug after 10 seconds.</li> </ol>
The filter indicator light flickers quickly (5 times per second)	<ol style="list-style-type: none"> <li>1. The unit needs to be reset</li> </ol>	<ol style="list-style-type: none"> <li>1. Unplug the unit and insert the plug after 10 seconds.</li> </ol>

## FEATURES OF YOUR PROGRAMABLE AIR PURIFIER

- HEPA Filter**  
 The HEPA filter will stop most dust particles and airborne allergens that pass through the filter. It will capture 99.97% of particles as small as 0.3 microns – many times smaller than a human hair.
- Ultraviolet Lamp**  
 The ultraviolet lamp can help kill bacteria and molds that pass through the filter. The result is a cleaner air output from the air purifier.
- Ionizer**  
 Filling the air with negative ions helps to freshen the air.  
**NOTE:** The ionizer function is a silent feature, the only way to know if it is "On" is with the indicator light.
- Built-in Dust Sensor**  
 Automatically adjusts the air flow through the air cleaner to help clean the air more efficiently.
- Built-In Odor Sensor**  
 This sensor monitors the air quality in the room and can detect tobacco, pet, cosmetic and alcohol-aerosol odors.
- Neutralize**  
 The UV and photo-catalysis process helps decompose odors in the air like formaldehyde, alcohol and ammonia.  
**NOTE:** The neutralize function is a silent feature, the only way to know if it is "On" is with the indicator light.
- Fan Speed Settings**  
 There are four fan speeds and an auto fan speed setting to clean your air more efficiently.
- Timer**  
 Set the air purifier to shut off after a specified number of hours.
- Set-Up**  
 Pre-program the unit to turn "On", turn "Off", and select the fan speed that would be desired.
- Change Filter Indicator**  
 This indicator reminds you when filters require replacing.

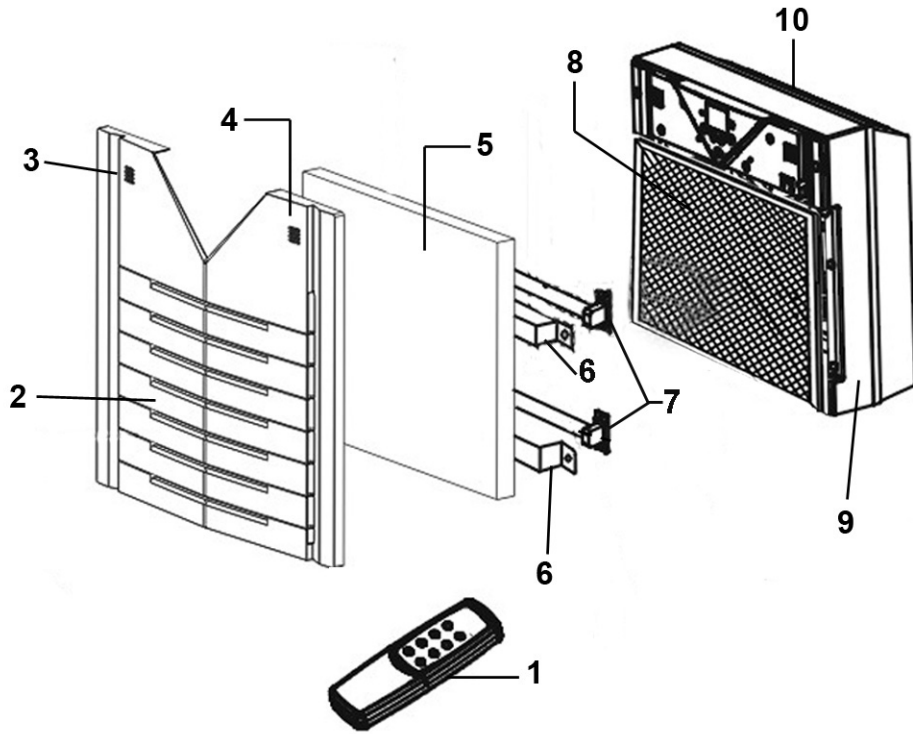

- |                             |                       |
|-----------------------------|-----------------------|
| 1. Remote Control*          | 6. UV Light Protector |
| 2. Air Intake Grill         | 7. UV Light           |
| 3. Dust Sensor              | 8. Neutralizer        |
| 4. Odor Sensor              | 9. Main Unit          |
| 5. Pre-Filter & HEPA Filter | 10. Air Outlet Grill  |

### Technical Specifications

Voltage: 120V., 60Hz.  
 Power: 108 Watts  
 Area Coverage: 300 sq ft

**Note:** Illustrations may differ from actual unit.

\* Please note that the 2 AAA batteries required for the remote control are not included.

### Replacing the UV Bulb

The Air Purifier is equipped with two UV bulbs. These bulbs will last approximately 8,000 hours (almost one (1) year of continuous use with the neutralizer activated).

1. Lay the unit down with face of unit upwards.
2. Grasp both corners of the bottom of the air intake grill and pull upwards. (Fig. 14)

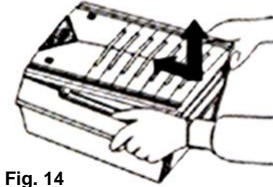

Fig. 14

3. Lift air intake grill gently towards top of unit to remove.
4. To remove the HEPA filter, pull up on the tags on either side of the filter and lift upwards. (Fig.15)

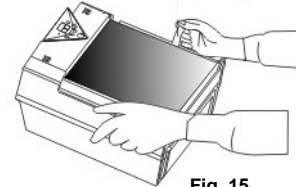

Fig. 15

5. There is a protective shade covering the UV bulbs. To remove the protective shade use a Phillips #2 screw driver to remove the screw on either end of the shade, then lift the shade off. (Fig. 16)

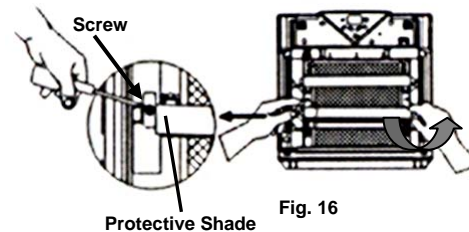

Fig. 16

**CAUTION:** Use care when removing the bulb. Always turn bulb from the base and not the light bulb.

6. Gently rotate the bulb one quarter turn clockwise until the bulb pins unlock from the socket. (Fig. 17)
7. Pull the pins out of the sides of the socket one end at a time.

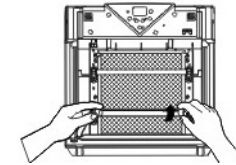

Fig. 17

8. Unpack the new bulb carefully, handling only the base and not the bulb. Place the new bulb into the socket with the pins pointing upwards. (Fig. 18)

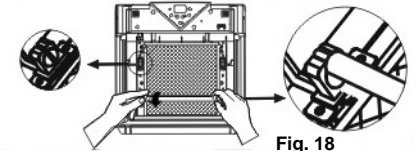

Fig. 18

- Important:** Oil from hands left on the bulb could interfere with the germicidal action and life of the bulb.
9. Rotate the new bulb one quarter turn counter clockwise to lock bulb into place.
  10. Replace protective shade and screw in the screws. (Fig. 19)

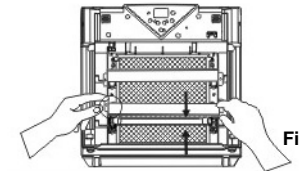

Fig. 19

**NOTE:** Ensure that no packing material has been left in the unit before replacing the HEPA filter.

11. Replace HEPA filter and cover on unit.

### Bulb Replacement:

Philips TUV 8 Watt T5 base. (Fig. 20)  
 Call Customer Service at 1 (800) 275-9251 for more information on bulb replacements.



Fig. 20

T5 Base



## MAINTENANCE INSTRUCTIONS

### Cleaning the Air Purifier

Disconnect the unit from the outlet before performing maintenance or troubleshooting.

It is recommended that you regularly clean the air intake grill and pre-filter between filter changes. Every 30 days is the recommended schedule.

1. Lay the unit down with face upwards.
2. Grasp both corners of the bottom of the air intake grill and pull upwards. (Fig. 8)



Fig. 8

3. Lift air intake grill gently towards top of unit, to remove.
4. To remove the HEPA filter, pull up on the tags on either side of the filter and lift upwards. (Fig. 9)

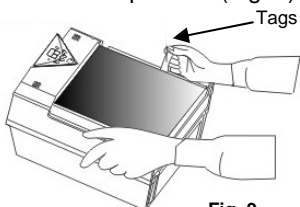

Fig. 9

5. To clean the pre-filter, pull the pre-filter up to remove it from the HEPA filter. (Fig. 10)

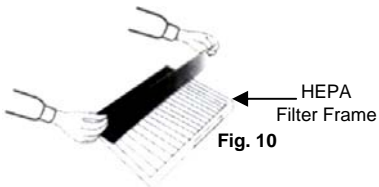

Fig. 10

6. Run under tap water until water runs clear. Allow to air dry for 24 hrs before replacing onto the HEPA filter frame. (Fig. 11)



Fig. 11

7. To clean the air intake grill, you may use a vacuum with a crevice tool to get trapped dust out from between the gaps. Then clean with a damp cloth to remove any extra dirt and dust. (Fig. 12)



Fig. 12

8. To replace the air intake grill, first attach the top of the grill and then snap in the lower part of the grill.

### Replacing the HEPA Filter

The HEPA filter should last approximately six (6) to nine (9) months depending on usage and household environment. The change filter indicator will illuminate when the filter requires replacing. Disconnect the unit from the power source before performing any maintenance or troubleshooting.

**WARNING:** Do not attempt to wash or vacuum the HEPA filter as this will cause damage to the filter.

1. Lay the unit down with face upwards.
2. Grasp both corners of bottom of the air intake grill and pull upwards. (Fig. 8)
3. To remove the HEPA filter, pull up on the tags on either side of the filter and lift upwards. (Fig. 9)
4. Remove the new HEPA filter from the bag.
5. There is a sticker located on the base and top of the HEPA filter, fill in the date that this filter was installed into the unit. This helps you keep track of when a new filter will be needed.
6. Insert the new HEPA filter into the air purifier with the arrow pointing down. (Fig. 13)

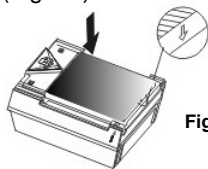

Fig. 13

7. To replace the air intake grill, first attach the top of the grill and then snap in the lower part of the grill.
8. To reset the clean filter indicator plug the unit in, turn the unit "On", then press and hold the timer button until the clean filter indicator turns off.

## OPERATING INSTRUCTIONS

### Before Using the Air Purifier

Remove all parts from packaging. Insert 2 AAA batteries into the remote control. Before use verify that the HEPA filter is in place:

1. Lay the unit down with face upwards.
2. Grasp both corners of the bottom of the air intake grill and pull upwards. (Fig. 1)

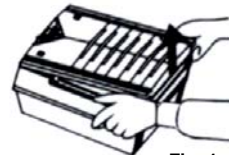
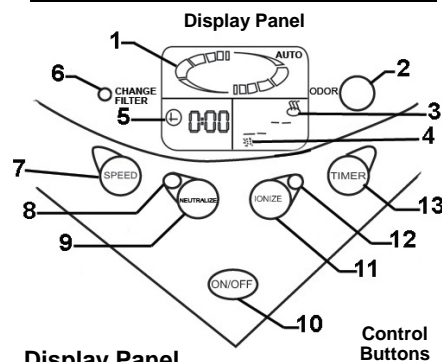

Fig. 1

3. To replace the air intake grill—insert the top of the air intake grill first and then snap in the lower part of the grill.
4. Plug the unit into an electric outlet, the unit will be ready to run.
5. Press the "On/Off" button on the display panel to turn the unit "On".

### Description of the Display Panel



### Display Panel

1. Fan Speed Indicator
2. Infra-Red Receptor
3. Odor Detected in Air Indicator
4. Dust Detected in Air Indicator
5. Timer Display
6. Change Filter Indicator

### Control Buttons

7. Fan Speed Control Button
8. Neutralize "On/Off" Indicator
9. Neutralize "On/Off" Control Button
10. "On/Off" Power Button
11. Ionizer Control Button
12. Ionizer "On/Off" Indicator
13. Timer Control Button

### Using the Air Purifier

1. Plug the unit into an electric outlet, the unit will be ready to run.
2. Press the "On/Off" button on the display panel to turn the unit "On". Repress the button to turn the unit "Off".

### Fan Speed

**NOTE:** There will be approximately a one (1) second delay between pressing the fan speed button and the unit changing speed.

1. When the unit is turned on, the fan will automatically start at medium speed for about 3 seconds and then default to low speed. The fan speed is indicated on the control panel.
2. To change the fan speed, press the fan speed control button on the front of the unit. Each time it is depressed the fan speed changes ranging from quiet to auto. (Fig. 2)



Fig. 2

Fan Settings:

- |           |         |
|-----------|---------|
| 1= Quiet  | 2= Low  |
| 3= Medium | 4= High |
|           | Auto    |

3. If you select the auto fan speed, the dust and odor sensors will detect the air quality in the room and will automatically adjust the fan speed.

**NOTE:** When the fan speed is in the "AUTO" mode, AUTO will appear at the top right hand corner of the display panel. The fan speed will appear after the sensors select the required fan speed for the most efficient cleaning.

## OPERATING INSTRUCTIONS

### The Odor Sensor

If the air purifier senses odors in the air, the indicator bar will increase to a maximum of four (4) bars. Adjust the fan speed to a desired level. The air purifier will automatically adjust the fan speed when it is in "AUTO" mode. (Fig. 3)

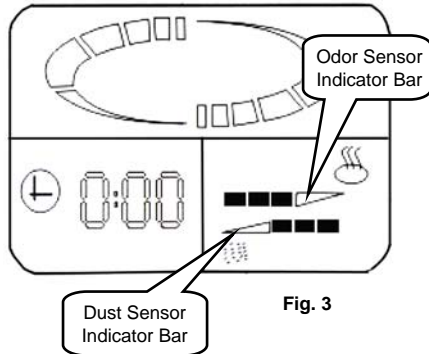

### The Dust Sensor

When more dust is detected in the air the indicator bar will increase to a maximum of four (4) bars. Adjust the fan speed to desired level. The air purifier will automatically adjust the fan speed when it is in "AUTO" mode. (Fig. 3)

### Ionizer

**NOTE:** The neutralize and the ionizer functions are silent features, the only way to know if they are "On" is with the indicator lights.

1. To turn the ionizer "On", press the ionizer button on the control panel or the remote control. The ionizer "On/Off" indicator will illuminate when "On".
2. To turn this feature "Off", depress the ionizer control button or remote button again. The ionizer "On/Off" indicator will no longer be illuminated. (Fig. 4)

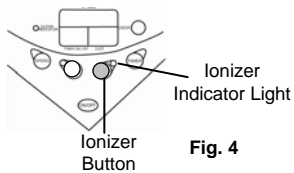

### Neutralize

The neutralize button turns the UV light "On" and begins the photo-catalysis process.

1. To turn the neutralize feature "On", press the neutralize button on the control panel or the remote control. The neutralize indicator light will illuminate when the feature is "On". (Fig. 5)
2. To turn this feature "Off" depress the neutralize button again on control panel or remote. The neutralize indicator light will no longer be illuminated.

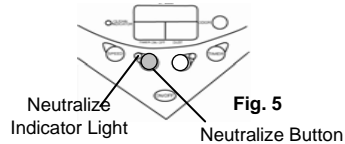

### Using the Timer

The timer button has 5 different cycles for automatic shut off. To use the timer button:

1. Depress the timer control button to preset when the unit will turn "Off".
2. With this feature, you have a choice of 1hr, 2 hrs, 4 hrs or 8 hrs. (Fig. 6)

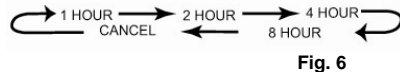

## OPERATING INSTRUCTIONS

### The Remote Control

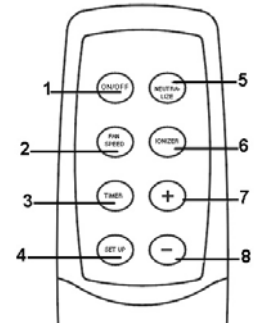

1. On/Off Button
2. Fan Speed Button
3. Timer
4. Set-Up
5. Neutralize Button
6. Ionizer Button
7. Increase Button
8. Decrease Button

**IMPORTANT:** The remote control requires two (2) AAA batteries which are not included with the unit. Do not mix old and new batteries. Do not mix alkaline, standard (carbon-zinc) or rechargeable (nickel-cadmium) batteries together.  
**NOTE:** The remote control functions best at a distance of less than 20 feet (6 meters).

1. **On/Off Power Button**  
This controls the power to the unit.
2. **Fan Speed Button**  
Each time this button is pressed it will cycle through the options for the fan speed. (See Using the Air Purifier.)
3. **Timer Button**  
This button only controls when the unit will shut-off automatically.
4. **Set Up Button (Pre-Program)**  
This allows you to pre-program "On" time, "Off" time, and fan speed. This feature can be used even if the air purifier is "Off".
5. **Neutralize**  
This button will turn on or turn off the photo-catalysis and UV light functions remotely.
6. **Ionizer Button**  
This button will turn on or turn off the ionizer function remotely.
7. **Increase Button ("+")**  
This button will increase time selected in the set up feature by half hour increments.
8. **Decrease Button ("-")**  
This button will decrease time selected in the set up feature by half hour increments.

### To Pre-Program Your Air Purifier

Use the set up control button on the remote to preset when the unit will turn "On", "Off", and which fan speed is desired when the unit is running.

1. Each time the set up button is pressed it goes through one of three cycles. (Fig. 7)

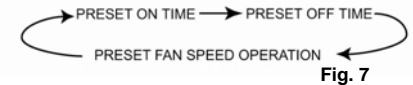

2. While the unit is "Off", press the set up button on the remote control. The "On" will flash on the timer display panel.
3. Press the "+" or the "-" button on the remote control to set the time. Each time you press the "+" button, the time will increase or decrease up to a maximum of 9 hours and 30 minutes. The "+" button will increase the time by 30 minute increments and the "-" button will decrease by 30 minute increments.
4. To set the time when the unit will turn "Off", depress the set up button again. The "Off" will flash on the display panel. Repeat step #3 to select desired "Off" time.
5. Depress the set up button on the remote control again to set the fan speed that is desired. The fan speed will flash indicating that fan speed will now be adjusted.
6. Depress the fan speed button or the increase ("+") to the required fan speed.
7. Once the fan speed is selected, after a moment a single "beep" will indicate a successful set-up and the display panel will display how many hours and minutes remain until the unit turns "On".

**IMPORTANT:** Three (3) "beeps" and a blank panel indicates incorrect data entry. Repeat set-up process.

**NOTE:** Auto fan speed is the only setting the dust sensors use to adjust the fan speed to what is required to clean the air. Manual adjustment is required if the unit is not in auto mode.



## Free Manuals Download Website

<http://myh66.com>

<http://usermanuals.us>

<http://www.somanuals.com>

<http://www.4manuals.cc>

<http://www.manual-lib.com>

<http://www.404manual.com>

<http://www.luxmanual.com>

<http://aubethermostatmanual.com>

Golf course search by state

<http://golfingnear.com>

Email search by domain

<http://emailbydomain.com>

Auto manuals search

<http://auto.somanuals.com>

TV manuals search

<http://tv.somanuals.com>