

# FANTOM®

## Commercial Stainless Steel Wet/Dry Vacuum

### OWNER'S MANUAL

Model CW233H  
120V., 60Hz., 8.3 Amps



**FANTOM**  
94 Main Mill Street, Door 16  
Plattsburgh, NY 12901  
Tel. :1 (800) 275-9251

**FOR HOUSEHOLD OR COMMERCIAL USE**



# IMPORTANT SAFETY INSTRUCTIONS

When using your **Wet/Dry Vacuum**, basic safety precautions should always be observed, including the following:

1. Read all instructions before using your vacuum.
2. Use the vacuum only for its intended use.
3. To protect against a risk of electric shock, do not immerse any part of the vacuum in water or other liquids.
4. **Never** yank cord to disconnect from outlet; instead, grasp plug and pull to disconnect.
5. **Do not** allow cord to touch hot surfaces.
6. **Do not** run appliance over cord.
7. **Do not** operate the vacuum with a damaged cord or plug, or if the appliance or any other part of the vacuum has been dropped or damaged. To avoid the risk of electric shock, do not disassemble or attempt to repair the vacuum. Return the vacuum to **FANTOM** (see warranty) for examination and repair. Incorrect re-assembly or repair can cause a risk of electrical shock or injury to persons when the vacuum is used.
8. Close supervision is necessary for any appliance being used by or near children. **Do not** leave the vacuum unattended while connected.
9. Keep hair, loose clothing, fingers and all parts of body away from any opening and moving parts.
10. **Do not use to pick up flammable or combustible liquids such as gasoline or use in areas where they may be present.**
11. **Do not** pick up anything that is burning or smoking such as cigarettes, matches or hot ashes.
12. Use extra care when cleaning on stairs.
13. This unit should not be used to pick up liquids from containers, sinks, tubs, etc.
14. **Do not** use on uneven surfaces. **Do not** tip/tilt unit over when in use.
15. Intended for indoor or outdoor use and for wet pick-up, but not intended to be exposed to rain.

## To reduce the risk of fire, electric shock, or injury:

- **Do not** leave the vacuum plugged in when unattended. Unplug the electrical cord when not in use and before servicing.
- **Do not** allow to be used as a toy. Close attention is necessary when used by or near children, pets or plants.
- Use only as described in this manual. Use only manufacturer's recommended accessories.
- **Do not** pull cord, use cord as a handle, close a door on cord, or pull cord around sharp edges or corners.
- **Do not** run unit over power cord. Keep cord away from heated surfaces.
- Use **only** extension cords UL-rated or cUL at 15 amperes. Extension cords rated for less amperage may overheat. Care should be taken to arrange the cord so that the cord cannot be pulled or tripped over.
- Turn off unit before unplugging from electrical outlet.
- **Do not** handle plug or vacuum with wet hands or operate without shoes.
- **Do not** put any objects into openings. Do not use with any opening blocked. Keep free of dust, lint, hair and anything else that may reduce air flow.
- Store your appliance indoors in a cool, dry area.
- Keep your work area well lit.
- **Do not** immerse the vacuum into water or other liquids.
- Keep end of hose, wands and other openings away from your face and body.
- Using improper voltage may result in damage to the motor and possible injury to the user. Correct voltage is listed on rating label.

**WARNING:** The power cord on this product contains lead, a chemical known to the State of California to cause birth defects or other reproductive harm. **Wash hands after handling.**

# SAVE THESE INSTRUCTIONS

## For Household or Commercial Use Only

### GROUNDING INSTRUCTIONS

This appliance must be grounded. If it should malfunction or breakdown, grounding provides a path of least resistance for electric current to reduce the risk of electric shock. This appliance is equipped with a cord having an equipment-grounding conductor and grounding plug. The plug must be inserted into an appropriate outlet that is properly installed and grounded in accordance with all local codes and ordinances.

**WARNING:** Improper connection of the equipment-grounding conductor can result in a risk of electric shock. Check with a qualified electrician or service person if you are in doubt as to whether the outlet is properly grounded. Do not modify the plug provided with the appliance - if it will not fit the outlet, have a proper outlet installed by a qualified electrician.

This appliance is for use on a nominal 120-volt circuit, and has a grounding attachment plug that looks like the plug illustrated at right. Make sure that the appliance is connected to an outlet having the same configuration as the plug. No adaptor should be used with this appliance.



# PARTS AND COMPONENTS

Note: Verify that all parts and components are included before assembly.

## Vacuum Parts



### Vacuum

1. Canister
2. Hose Intake
3. Locking Clasp
4. Canister Handle (x2)
5. Power Cord and Hose Storage
6. On/Off Power Switch

7. Flexible Hose
8. Extension Tubes (x2)
9. Crevice Tool
10. Floor to Carpet Brush
11. Squeegee Brush
12. Filter Cartridge
13. Dust Bag
14. Foam Filter

## Caddy Parts

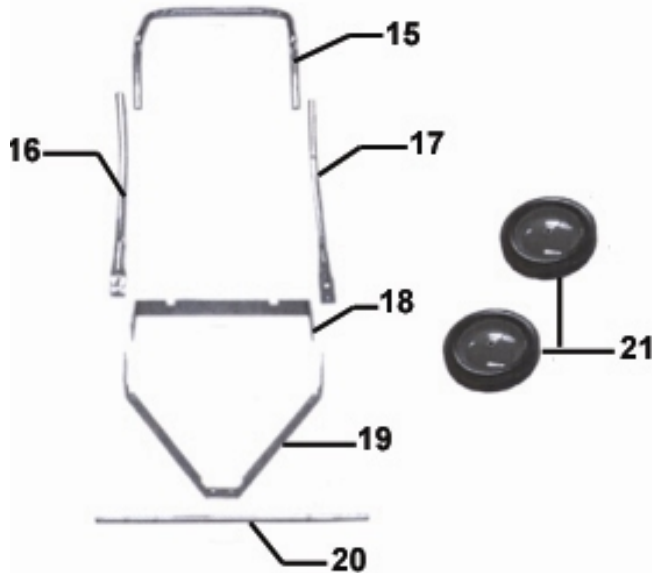

### Caddy Parts

15. Caddy Handle
16. Caddy Support (Left)
17. Caddy Support (Right)
18. Rear Caddy Frame
19. Front Caddy Frame
20. Axel
21. Rear Wheels (x2)

## Caddy Hardware

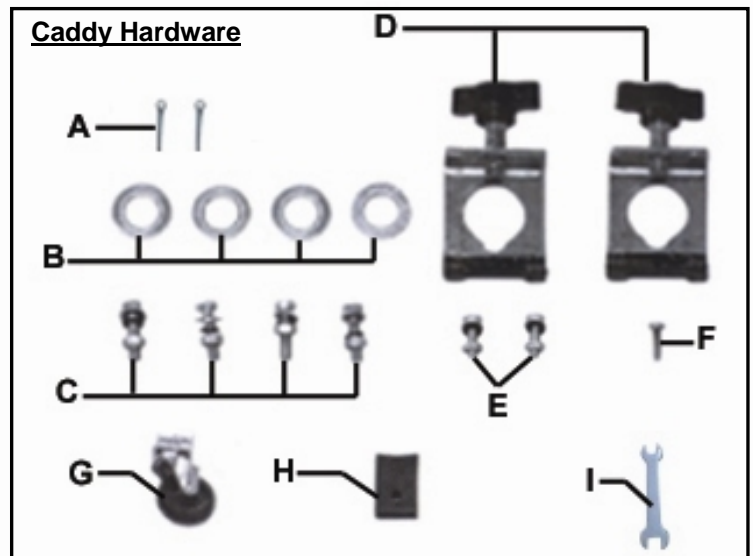

### Caddy Hardware

- A. Cotter Pins (x2)
- B. Flat Washers (x4)
- C. Bolt / Lock Washer / Nut (x4)
- D. Caddy Support Brackets (x2)
- E. Bolt / Lock Washer / Nut for Caster (x2)
- F. Hex. Slot Head Screw
- G. Caster Assembly
- H. Bracket Cover
- I. Wrench

## Technical Specifications

Voltage: 120V., 60Hz.  
Power: 8.3 Amps, 1000 Watts

\* Illustrations may differ from actual product.

# ASSEMBLING THE CADDY

## Assembling the Caddy

Your vacuum cleaner requires some assembly. Ensure that all parts listed on the "Parts and Components" page are included in the packaging.

## Tools Required for Assembly



Phillips Screwdriver  
(not included)



Wrench  
(included)

1. Assemble the caddy frame first. Parts required for this step:

- caddy support (left)
- caddy support (right)
- rear caddy frame and front caddy frame
- 4 Bolt / Lock Washer / Locking Nut (Fig. 1)

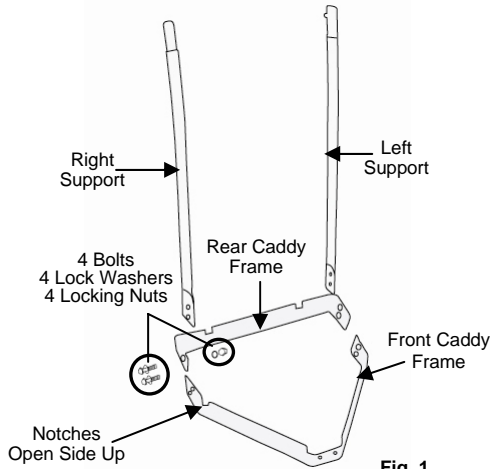

Fig. 1

2. Make sure the notches on the caddy frame pieces are sitting open side up. Fit the front caddy frame into the rear caddy frame. (Fig. 2)
3. Place the right support on the inside of the right side of the caddy frame, aligning all openings.

- Note:** The front caddy support will have to be squeezed to join with rear caddy support.
4. Secure the right support with bolt and lock washer. [C]
  5. On the inside place a washer onto the bolt and fasten with locking nut [C]. (Fig. 2)

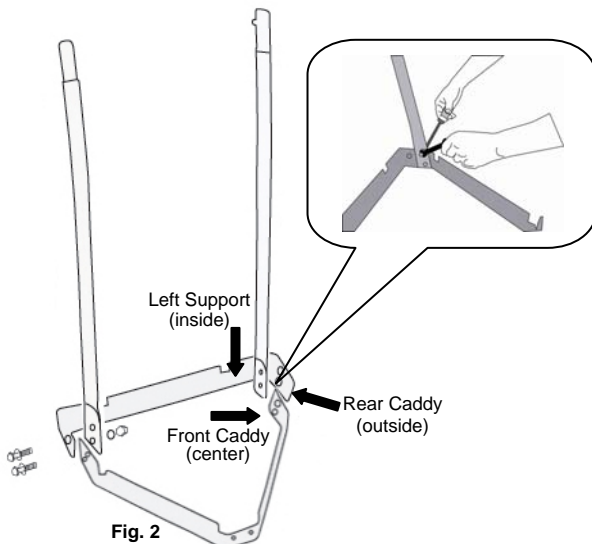

Fig. 2

6. Repeat with the left support securing to the caddy frame.
7. Ensure all fastenings are tight using a Phillips screw driver (not included) and the wrench (included).
8. Slide the axel through the holes in the rear frame. (Fig. 4)
9. On the outside side of the axel, place a washer in the groove nearest to the frame. (Fig. 3)

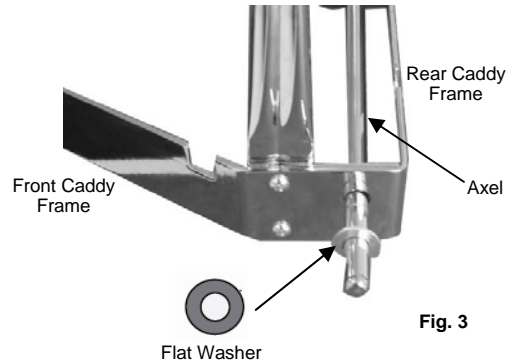

Fig. 3

10. Slide a rear wheel onto each side of the axel.
11. Place a flat washer against the outside of each wheel onto the axel. Repeat on the opposite side wheel.
12. Secure each wheel with a cotter pin placed in the hole and wrapped around the axel to secure the wheel to the axel. (Fig. 4)

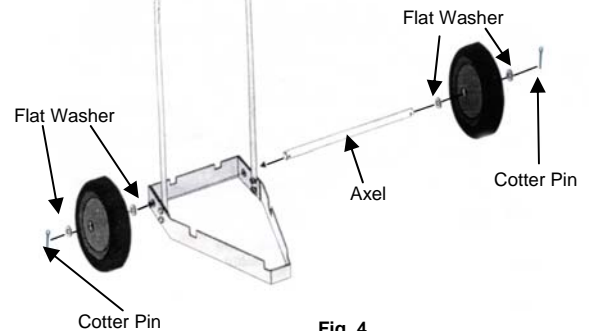

Fig. 4

13. Assemble the bracket cover [I] on the caster bracket and then use the screw [F] to fasten. (Fig. 5)



Fig. 5

# ASSEMBLING THE CADDY

## Assemble the Vacuum to the Caddy

1. Make sure that the hose intake is facing forwards and the wheels are at the rear of the unit. Using the handles on the canister, carefully lower it onto the frame aligning the canister edge with the notches in the frame. (Fig. 6)

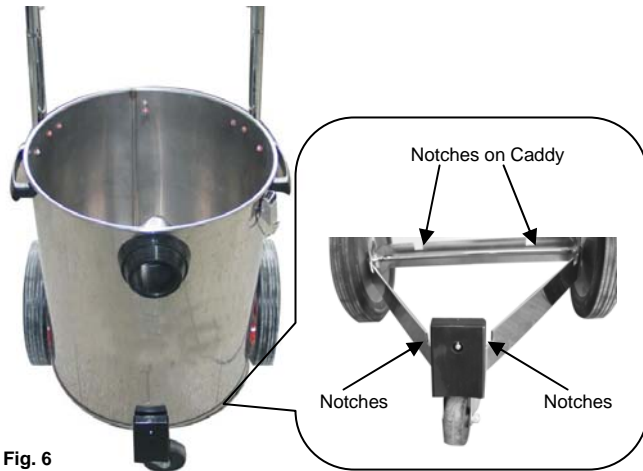

Fig. 6

2. To attach the canister to the handle supports, align the canister brackets on each side of canister with the supports. (Fig. 7)
3. With the clamp assembly tabs facing downwards, slide a clamp assembly onto the right and left caddy support. (Fig. 7)

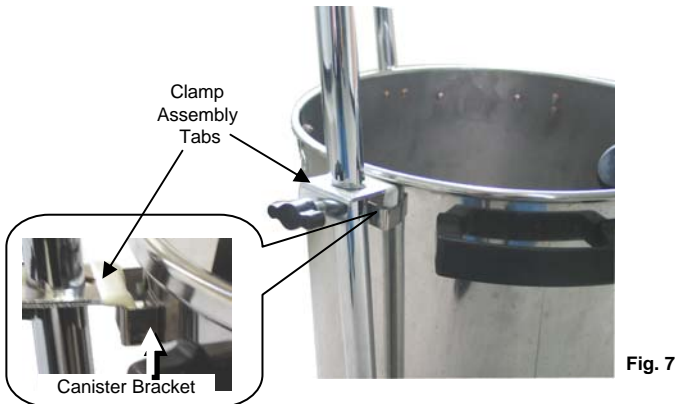

Fig. 7

4. Place the clamp assembly tabs onto the canister brackets on each side of the canister.
5. Tighten the clamp assembly by turning the hand nut clockwise until it is secured on the supports. (Fig. 8)



Fig. 8

6. To insert the caddy handle onto the right and left caddy supports, fit the ends of the caddy handle into the openings of the left and right caddy supports and push down until the caddy handle clicks into place. (Fig. 9)



Fig. 9

## Filter Assembly

This wet/dry vacuum requires different filter assembly for wet or dry pick-up. The filter cartridge and dust bag are required for dry pick-up. (Fig. 10) The foam filter is required for wet pick-up. (Fig. 11)

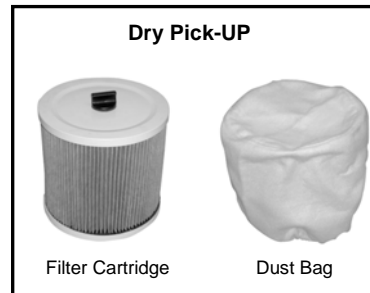

Fig. 10



Fig. 11

## For Dry Pick-Up

**Warning:** To reduce risk of electric shock - unplug before cleaning, assembly or emptying canister.

1. To assemble the filter for dry pick up, turn the filter holder upside down on a level surface. (Fig. 12)
2. Place the filter cartridge onto the filter holder, ensuring that the locking tab inside the filter cartridge is aligned with the slot on the filter holder and turn the locking knob until it stops. (Fig. 13)



Fig. 12

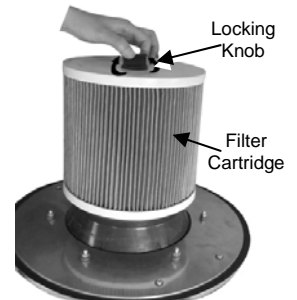

Fig. 13

**Important:** Do not operate the vacuum without the filter cartridge and dust bag in place for dry pick-up



# OPERATING INSTRUCTIONS

- Place the dust bag onto the filter cartridge, ensuring that the elastic at the bottom of the bag is at the bottom of the filter. (Fig. 14)
- Turn the filter holder over and place in the vacuum canister with the power cord in the rear.

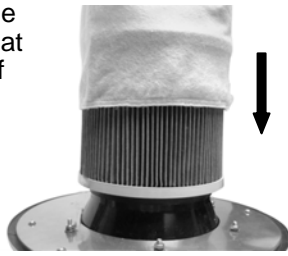

Fig. 14

**Warning:** Grasp the power cord and hose storage on the filter holder to place the assembly into the canister, as cuts may occur from edge of filter holder.

- Secure the filter holder with the three (3) locking clasps. (Fig. 12)

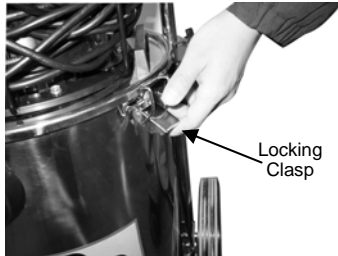

Fig. 15

## For Wet Pick-Up

**Warning:** To reduce risk of electric shock - unplug before cleaning, assembly or emptying canister.

- To assemble the filter for wet pick up, turn the filter holder upside down on a level surface. (Fig. 12)
- Remove the dust bag and filter cartridge from the filter holder.
- Place the foam filter over the filter holder. (Fig. 16)

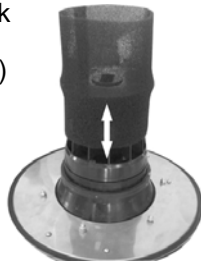

Fig. 16

**Important:** Do not use the filter cartridge or the dust bag for wet pick-up.

- Ensure that the foam filter is all the way down on the filter holder.
- Follow the instructions from the "For Dry Pick-Up" section to assemble the filter holder onto the canister.

**Warning:** If water is seen to be coming from the exhaust - immediately turn the unit off and unplug from electrical outlet. Empty canister and clean.

**Important:** This unit is supplied with a safety feature that will stop air flow if the tank is overfilled or tips over. If the airflow is stopped, turn the vacuum off, empty the canister, then reassemble the vacuum and continue vacuuming.

## Assemble the Hose

- Insert the wide end of the hose into the hose intake. (Fig. 17)
- Attach one of the extension tubes onto the handle part of the flexible hose. (Fig. 18)



Fig. 17

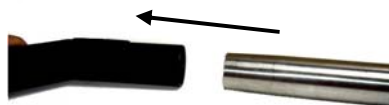

Fig. 18

- For a longer reach you can attach the other extension tube to the first one.
- Attach the desired attachment for the task onto the end of the extension tube or directly onto the handle of the flexible hose. (Fig. 19)



Fig. 19

## Operating Your Wet/Dry Vacuum

**Warning:** To reduce the risk of fire or explosion, **do not** operate this unit in areas with flammable gases, vapors or explosive dust in the air. Flammable gases or vapors include but are not limited to: lighter fluid, solvent type cleaners, oil base paints, gasoline, alcohol or aerosol sprays. Explosive dusts include but are not limited to; coal, magnesium, grain or gun powder. **Do not** vacuum explosive dust, flammable or combustible liquids or hot ashes. To reduce the risk of health hazards from vapors or dusts, **do not** vacuum toxic materials.

## Attachments

**Floor to Carpet Brush** – Used for dry pick-up. To use for carpets press toggle switch down to the front of the brush to raise the bristles; to switch to bare floor setting press the toggle switch to the back of the brush to lower the bristles.



**Crevice Tool** – Use for wet or dry pick-up in tight corners, good for automobiles etc.



**Squeegee** - Use for wet pick-up on flat surfaces to pick up liquids and dry the surface quicker.



**Extension Tubes** – For an extended reach insert one or two of the extension tubes onto the flexible hose. Slide one tube into the other, then slide the extension tube assembly into the handle end of the flexible hose. Attachments slide easily onto the handle end of the flexible hose or the extension tubes.



# OPERATING INSTRUCTIONS

## Dry Material Vacuuming

**Warning:** To reduce risk of electric shock - unplug before cleaning or emptying canister.

**Caution:** To reduce the risk of hearing damage wear ear protectors when using the unit for extended periods of time or when in a noisy area. The operation of any utility vacuum can result in foreign objects being blown into the eyes, which can result in severe eye damage. Always wear safety goggles complying with ANSI Z87.1 (or in Canada CSA Z94-3-M88) shown on the package before commencing operation.

**Caution:** To avoid damage to the motor only use the filter cartridge and dust bag for dry pick-up.

**Note:** To dry the unit if your vacuum was recently used for wet pick-up, run the vacuum with the filter cartridge and dust bag in place without the hose attached for approximately 10 minutes. The air circulating through the unit will dry it.

1. Ensure that the filter cartridge and dust bag are correctly installed to avoid leaks and possible motor damage to the vacuum.
2. Attach the flexible hose, extension tube(s) and desired attachment.
3. Plug unit into electrical wall outlet. Turn the power On/Off switch to the "On" position.
4. To keep your unit in good running order, empty the canister and clean the dust bag and filter cartridge frequently, especially when using to pick up fine dust or fine debris. This will prevent a build up of mold or mildew.

## Liquid or Wet Vacuuming

**Warning:** Do not vacuum up flammable or combustible liquids such as gasoline or use in areas where they may be present.

**Caution:** To avoid damage to the unit always use the foam filter for wet pick-up.

1. Unplug unit from electrical wall outlet.
2. Place the foam filter on the filter holder and secure the filter holder into place on the canister.
3. Attach the flexible hose, extension tube(s) and desired attachment.
4. Plug unit into electrical wall outlet, and turn the On/Off power switch to the "On" position.
5. When vacuuming up large amounts of liquid, make sure that the canister is not too full to avoid injury when emptying the canister.

**Caution:** Avoid tipping the unit when full of water.

6. If the liquid being vacuumed passes a specified amount, a float valve will rise automatically and cut off the airflow to the unit. If this occurs, turn the unit "Off" and unplug the power cord. Empty the canister of any liquid. The float valve will go down after the unit is turned off.
7. When finished vacuuming up the liquids, empty the canister, remove the flexible hose and run the vacuum for approximately 10 minutes to dry the foam filter. This will prevent a build up of mold or mildew.

## Cleaning and Maintenance

**Warning:** To reduce risk of electric shock - unplug before cleaning, assembly or emptying canister.

**Warning:** To reduce the risk of back injuries or falls, never lift the vacuum if the canister is full of liquid or debris because it is heavy. Scoop or drain enough of the contents to lighten the canister enough so that it can be lifted comfortably.

1. Turn the unit "Off".
2. Unplug unit from electrical wall outlet.
3. To empty the canister, first remove the filter holder from the canister.
4. Lift canister off of the caddy and empty into the appropriate waste container.
5. When emptying liquids from the canister it is suggested that the canister be tipped over carefully so that liquid could spill into a drain pipe.

**Warning:** Be careful not to empty any liquid onto the power cord or the filter holder as this could damage the motor.

**Warning:** Lifting heavy objects can cause injury. Empty frequently to avoid excessive weight.

## Cleaning / Replacing Foam Filter

1. Turn the unit "Off".
2. Unplug the unit from the electrical outlet.
3. Remove the filter holder from the canister
4. Remove the foam filter from the filter holder.
4. The foam filter should be cleaned after every use. A severely soiled or clogged filter should be thoroughly washed with fresh tepid water. A mild detergent may be used if required. (Fig. 20)
5. Let the foam filter air dry completely before replacing into the vacuum. (Fig. 21) **Do not** use a washing machine to wash or rinse the filter. **Do not** use a hair dryer to dry it. Air dry only. **Never** operate the vacuum for wet pickup without the foam filter in place.



Fig. 20

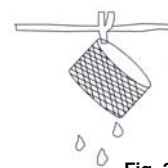

Fig. 21



# OPERATING INSTRUCTIONS

## Cleaning / Replacing Filter Cartridge / Dust Bag

**Warning:** To reduce risk of electric shock - unplug before cleaning, assembly or emptying canister.

**Warning:** If picking up any type of renovating dust a protective mask should be worn.

The filter cartridge is washable. It should, however, be replaced every three (3) to six (6) months depending on usage to ensure peak performance of your vacuum.

### **Cleaning and Replacing the Filter Cartridge:**

1. Turn the unit "Off".
2. Unplug the unit from the electrical outlet.
3. Remove the filter holder from the canister.
4. Remove the dust bag from the filter holder.
5. Turn the locking knob to unlock the filter cartridge from the filter holder. (Fig. 22)

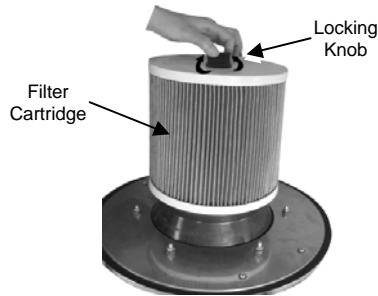

Fig. 22

6. Vigorously "TapClean" the filter cartridge on a hard surface until no more dust is observed falling out from between the pleats of the filter.
7. Replace the dust bag over the filter cartridge.
8. Replace the filter cartridge and reinstall the filter holder in the vacuum. (not shown)
9. Turn the locking knob to lock the filter cartridge from the filter holder. (Fig. 22)

### **Cleaning and Replacing the Dust Bag:**

1. Turn the unit "Off".
2. Unplug the unit from the electrical outlet.
3. Remove the filter holder from the canister.
4. Remove the dust bag from the filter holder.
5. Wash the dust bag in lukewarm water.
6. Let the dust bag air dry completely before reinstalling onto the filter holder.

**Note:** The dust bag is washable but it should be replaced every three (3) to six (6) months depending on usage.

## Motor Thermostat

**Important:** This unit is equipped with a motor protective thermostat. If some reason the wet/dry vacuum should overheat, the thermostat will automatically turn the unit off. Should this occur:

- Push the On/Off switch once.
- Disconnect the plug from the power source.
- Check the source of overheating problem. (i.e. clogged hose or filter).
- Wait at least 45 minutes before attempting to reuse the vacuum.
- After unit has cooled down for 45 minutes, plug in the vacuum and push the On/Off switch to the "On" position. The vacuum should start again.
- If the vacuum still does not start, contact customer service at 1 (800) 275-9251.

## TROUBLESHOOTING GUIDE

PROBLEM	POSSIBLE REASON	POSSIBLE SOLUTION
<b>VACUUM WILL NOT OPERATE</b>	<ol style="list-style-type: none"> <li>1. Power cord not firmly plugged into outlet.</li> <li>2. No power in wall outlet.</li> <li>3. Needs servicing.</li> <li>4. Thermostat has tripped.</li> </ol>	<ol style="list-style-type: none"> <li>1. Plug unit in firmly.</li> <li>2. Check fuse or breaker. Replace fuse/reset breaker.</li> <li>3. Call 1 (800) 275-9251.</li> <li>4. Turn the unit off and unplug from outlet. Allow unit to cool down, then restart.</li> </ol>
<b>VACUUM WILL NOT PICK-UP OR SUCTION POWER IS WEAK</b>	<ol style="list-style-type: none"> <li>1. Canister is full.</li> <li>2. Unit clogged.</li> <li>3. Flexible hose / extension tube clogged.</li> </ol>	<ol style="list-style-type: none"> <li>1. Empty canister.</li> <li>2. Turn unit off and unplug from wall outlet. Check for object(s) in air duct and remove.</li> <li>3. Turn unit off and unplug from wall outlet. Check for objects in flexible hose / extension tube.</li> </ol>
<b>WATER ESCAPING FROM THE EXHAUST</b>	<ol style="list-style-type: none"> <li>1. The canister is full.</li> </ol>	<ol style="list-style-type: none"> <li>1. Empty the canister.</li> </ol>

## ORDERING REPLACEMENT PARTS

### TO ORDER REPLACEMENT FILTER CARTRIDGE, FOAM FILTER OR DUST BAGS OR FOR TECHNICAL SUPPORT for Model CW233H

Tel.: 1 (800) 275-9251  
Monday to Friday 8:30 A.M. - 5:00 P.M. Eastern Standard Time

**Please Note:** Filter cartridge, foam filter and dust bag are washable. They should, however, be replaced every three (3) to six (6) months, depending on usage, to ensure peak performance of your vacuum.

**Important:** Make sure that dust bag and the foam filter have completely air dried before re-installing back into the vacuum.

Model  
CW233H



## THREE (3) YEAR LIMITED WARRANTY

**FANTOM** warrants this product to be free from defects in material and workmanship for a period of three (3) years from the date of the original purchase. This warranty applies only to normal domestic household use.

Should your appliance fail to operate properly while in use under normal commercial or household conditions within the warranty period, return the complete appliance and accessories, freight prepaid to:

**FANTOM**, 94 Main Mill Street, Door 16, Plattsburgh, NY 12901

If the appliance is found by **FANTOM** to be defective in material or workmanship, **FANTOM** will repair or replace it free of charge. Proof of purchase date must be included. \*

Non-durable parts including, without limitation, dust bags, filters, brushes and electrical parts which normally require replacement are specifically excluded from warranty.

The liability of **FANTOM** is limited solely to the cost of the repair or replacement of the unit at our option. This warranty does not cover normal wear of parts and does not apply to any unit that has been tampered with or used for commercial purposes. This limited warranty does not cover damage caused by misuse, abuse, negligent handling or damage due to faulty packaging or mishandling in transit. This warranty does not cover damage or defects caused by or resulting from damages from shipping or repairs, service or alterations to the product or any of its parts, which have been performed by a repair person not authorized by **FANTOM**.

This warranty is extended to the original purchaser of the unit and excludes all other legal and/or conventional warranties. The responsibility of **FANTOM** if any, is limited to the specific obligations expressly assumed by it under the terms of the limited warranty. **In no event is FANTOM liable for incidental or consequential damages of any nature whatsoever.** Some states do not permit the exclusion or limitation of incidental or consequential damages, so the above may not apply to you.

This warranty gives you specific legal rights, and you may also have other rights which vary from state to state.

**\*Important: Carefully pack item to avoid damage in shipping. Be sure to include proof of purchase date and to attach tag to item before packing with your name, complete address and phone number with a note giving purchase information, model number and what you believe is the problem with item. We recommend you insure the package (as damage in shipping is not covered by your warranty). Mark the outside of your package "ATTENTION CUSTOMER SERVICE".**

We are constantly striving to improve our products, therefore the specifications contained herein are subject to change without notice.



## OWNERSHIP REGISTRATION CARD

Please fill out and mail the product registration card within ten (10) days of purchase. The registration will enable us to contact you in the unlikely event of a product safety notification. By returning this card you acknowledge to have read and understood the instructions for use, and warnings set forth in the accompanying instructions.

**RETURN TO FANTOM: 94 Main Mill Street, Door 16, Plattsburgh, NY 12901**

**Model CW233H**

Appliance model

Date purchased

Name of store

Owner's name

Address

City

State

Zip Code

## Free Manuals Download Website

<http://myh66.com>

<http://usermanuals.us>

<http://www.somanuals.com>

<http://www.4manuals.cc>

<http://www.manual-lib.com>

<http://www.404manual.com>

<http://www.luxmanual.com>

<http://aubethermostatmanual.com>

Golf course search by state

<http://golfingnear.com>

Email search by domain

<http://emailbydomain.com>

Auto manuals search

<http://auto.somanuals.com>

TV manuals search

<http://tv.somanuals.com>