



CYCLONIC BAGLESS UPRIGHT

OWNER'S MANUAL
Model FM718
120V., 60Hz., 12 Amps



FANTOM
94 Main Mill Street, Door 16
Plattsburgh, NY 12901
Tel.: 1 (800) 275-9251
www.fantom.com



ONE (1) YEAR LIMITED WARRANTY

FANTOM warrants this product to be free from defects in material and workmanship for a period of one (1) year from the date of the original purchase. This warranty applies only to normal domestic household use. Should your appliance fail to operate properly while in use under normal household conditions within the one (1) year warranty period, return the complete appliance and accessories, freight prepaid to:

FANTOM 94 Main Mill Street, Door 16, Plattsburgh, NY 12901

Should the appliance is found to be defective in material or workmanship, **FANTOM** will repair or replace it free of charge. Proof of purchase date and \$16.95 to cover the cost of return shipping and handling must be included. * Non-durable parts including, without limitation, drive belts, rotating brushes, bulbs and electrical parts which normally require replacement are specifically excluded from warranty.

The liability of **FANTOM** is limited solely to the cost of the repair or replacement of the unit at our option. This warranty does not cover normal wear of parts and does not apply to any unit that has been tampered with or used for commercial purposes. This limited warranty does not cover damage caused by misuse, abuse, negligent handling or damage due to faulty packaging or mishandling in transit. This warranty does not cover damage or defects caused by or resulting from damages from shipping or repairs, service or alterations to the product or any of its parts, which have been performed by a repair person not authorized by **FANTOM**.

This warranty is extended to the original purchaser of the unit and excludes all other legal and/or conventional warranties. The responsibility of **FANTOM** if any, is limited to the specific obligations expressly assumed by it under the terms of the limited warranty. **In no event** is **FANTOM** liable for incidental or consequential damages of any nature whatsoever. Some states do not permit the exclusion or limitation of incidental or consequential damages, so the above may not apply to you.

This warranty gives you specific legal rights, and you may also have other rights which vary from state to state.

***Important: Carefully pack item to avoid damage in shipping. Be sure to include proof of purchase date and to attach tag to item before packing with your name, complete address and phone number with a note giving purchase information, model number and what you believe is the problem with item. We recommend you insure the package (as damage in shipping is not covered by your warranty). Mark the outside of your package "ATTENTION CUSTOMER SERVICE". We are constantly striving to improve our products, therefore the specifications contained herein are subject to change without notice.**

IMPORTANT SAFETY INSTRUCTIONS

When using your *Bagless Upright Vacuum*, basic safety precautions should always be observed, including the following:

- WARNING:** To reduce the risk of fire, electrical shock, or injury:
1. Do **NOT** leave vacuum cleaner unattended when it is plugged in. Unplug from outlet when not in use and before removing filters.
 2. To reduce the risk of electric shock – do **NOT** use outdoors or on wet surfaces.
 3. Do **NOT** allow children to use as a toy. Close attention is necessary when used by or near children.
 4. Use only as described in this manual. Use only manufacturer's recommended attachments.
 5. Do **NOT** use with damaged cord or plug. Do **NOT** use vacuum cleaner if it has been dropped, damaged, left outdoors, or dropped into water. Return appliance to **FANTOM** for examination, repair or adjustment.
 6. Do **NOT** pull or carry by cord. Do **NOT** use cord as a handle, close a door on cord, or pull cord around sharp edges or corners. Do **NOT** run appliance over cord. Keep cord away from heated surfaces.
 7. Do **NOT** unplug by pulling on cord. To unplug, grasp the plug, not the cord.
 8. Do **NOT** handle plug or vacuum cleaner with wet hands.
 9. Do **NOT** use the vacuum cleaner to pick up large objects or objects that are likely to damage the vacuum cleaner.
 10. Keep hair, loose clothing, fingers, feet and all parts of body away from openings, rotating agitator and other moving parts. Do **NOT** operate cleaner in bare feet or when wearing open toe shoes.
 11. Do **NOT** pick up hot coals, cigarette butts, matches or any hot, smoking, or burning objects.
 12. Do **NOT** pick up hard or sharp objects such as glass, nails, screws, coins, etc.
 13. Do **NOT** use without filters in place. Use **ONLY** filters and accessories provided by FANTOM. Failure to do so will void the warranty.
 14. Turn off all controls before plugging or unplugging vacuum cleaner into electrical outlet.
 15. Use extra care when vacuuming on stairs.
 16. Do **NOT** pick up flammable or combustible materials (lighter fluid, gasoline, kerosene, etc.) or use in the presence of explosive liquids or vapor.
 17. Do **NOT** pick up toxic material (chlorine bleach, ammonia, drain cleaner, etc.).
 18. Do **NOT** use in an enclosed space filled with vapors given off by oil based paints, paint thinner, moth proofing substances, flammable dust, or other explosive or toxic vapors.
 19. Use only on dry, indoor surfaces.
 20. Do **NOT** use for any purpose other than described in this user's guide.
 21. The use of an extension cord is not recommended.
 22. Do **NOT** put any objects into openings. Do **NOT** use with any opening blocked. Keep free of dust, lint, hair and anything else that may reduce air flow.
 23. Store your appliance indoors in a cool, dry area.
 24. Keep your work area well lit.
 25. Do **NOT** immerse the vacuum into water or other liquids.
 26. Keep end of hose, wands and other openings away from your face and body.
 27. To avoid damaging the carpet, keep the vacuum cleaner head moving at all times.

SAVE THESE INSTRUCTIONS For Household Use Only

WARNING: To reduce the risk of electric shock, this appliance has a polarized plug (one blade is wider than the other). This plug will fit in a polarized outlet only one way. If the plug does not fit fully in the outlet, reverse the plug. If it still does not fit, contact a qualified electrician to install the proper outlet. Do **NOT** modify the plug in any way.

PRECAUTIONARY MEASURES

Important: If the suction opening in the unit, the hose or the extension tube become blocked, switch off the vacuum cleaner and remove the blocking substance before you start the unit again.

1. Do not operate the vacuum cleaner to close too heaters, or radiators.



2. Before inserting the power plug into the wall outlet, make sure that your hands are dry.

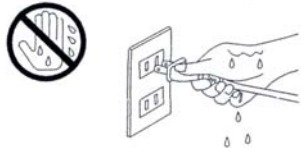

3. Do not vacuum any liquids.



4. Keep hair, loose clothing, fingers, feet and all parts of body away from openings, rotating agitator and other moving parts.

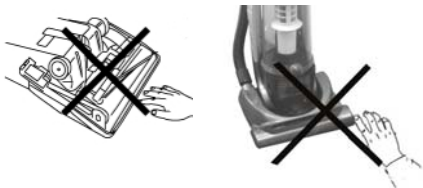

5. When pulling out the power plug from the wall outlet, pull the plug not the power cord.

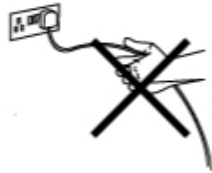

6. Do not pick up anything that is burning or smoking such as cigarettes, matches or hot ashes.

7. Do not run appliance over power cord.



8. Do not use without dust cup filter or filters in place.

9. Before you start vacuuming, make sure to remove large or sharp objects that might damage the vacuum.



Fantom

CYCLONIC BAGLESS UPRIGHT TO ORDER REPLACEMENT FILTERS OR BELTS OR FOR TECHNICAL SUPPORT for Model FM718

Call: 1 (800) 275-9251

Monday to Friday 8:30 A.M. - 5:00 P.M. Eastern Standard Time
or

visit our website: www.fantom.com

Please Note:

Filter Ring, Pre-Motor, Secondary and Exhaust Filters are washable. They should however be replaced every three (3) months to ensure peak performance of your vacuum.

The HEPA Dust Cup Filter may be washed. It should, however, be replaced every three (3) to six (6) months, depending on amount of use, to ensure peak performance of your vacuum. We recommend washing it once a month or when suction appears to be reduced. To wash your HEPA Dust Cup Filter, hold filter cartridge by frame flange and rinse under a tap until all observable dirt has been removed. Some discoloration of the HEPA filter material may occur, this is normal and will not affect the filter's performance. When finished, shake off excess water. Do **NOT** wash in dishwasher.

It is important that when you wash the HEPA dust cup filter, filter ring, secondary filter, pre-motor filter or the exhaust filter you allow them to dry **COMPLETELY** before using again. We recommend 24 hours to air dry. **DO NOT DRY IN DRYER.**

Important:

Make sure that ALL washable Filters are **completely** dry before inserting back in the vacuum.

PROBLEM SOLVING

This appliance was inspected thoroughly and was in good operating condition when it was shipped from the factory. If a minor problem occurs, it usually can be solved quite easily when the cause is found. Therefore, this checklist is provided for your convenience.

PROBLEM	POSSIBLE CAUSE	POSSIBLE
Cleaner Won't Run	<ol style="list-style-type: none"> 1. Not properly plugged into wall outlet. 2. No electricity in wall outlet. 3. On/Off switch not turned on. 4. Motor thermostat tripped. 5. Blown fuse/tripped breaker. 	<ol style="list-style-type: none"> 1. Plug in firmly. 2. Check fuse or breaker. 3. Push on/off switch to on. 4. Reset motor thermostat. (page 8) 5. Reset circuit breaker or replace fuse.
Cleaner Won't Pick Up	<ol style="list-style-type: none"> 1. Full or clogged dust cup. 2. Wrong pile height setting. 3. Clogged nozzle. 4. Clogged dust inlet port. 5. Clogged hose. 6. Broken belt. 7. Hose not inserted fully. 8. Dirty filters. 9. HEPA filter needs cleaning or replacing. 10. HEPA filter frame needs cleaning. 	<ol style="list-style-type: none"> 1. Clean dust cup. (page 5) 2. Adjust setting. (page 5) 3. Remove obstruction. 4. Remove power head cover and remove obstruction. 5. Remove obstruction. 6. Replace belt. (page 8) 7. Push hose in securely. 8. Clean / change filters. (page 7) 9. Clean or replace HEPA filter. (page 6) 10. Clean HEPA filter frame. (page 6)
Cleaner Picks Up Moveable Rugs Or Pushes Too Hard	<ol style="list-style-type: none"> 1. Wrong pile height setting. 	<ol style="list-style-type: none"> 1. Adjust setting. (page 5)
Agitator Does Not Turn	<ol style="list-style-type: none"> 1. Broken belt. 2. Belt installed incorrectly. 	<ol style="list-style-type: none"> 1. Replace belt. (page 8) 2. Check belt changing and agitator cleaning. (page 8)
Air Flow Restricted With Attachment Use Sound Changes	<ol style="list-style-type: none"> 1. Attachment use restricts air flow. 2. New carpet debris clogging air path. 	<ol style="list-style-type: none"> 1. Check attachment. (page 4) 2. Remove obstruction.

GETTING TO KNOW YOUR CYCLONIC BAGLESS UPRIGHT

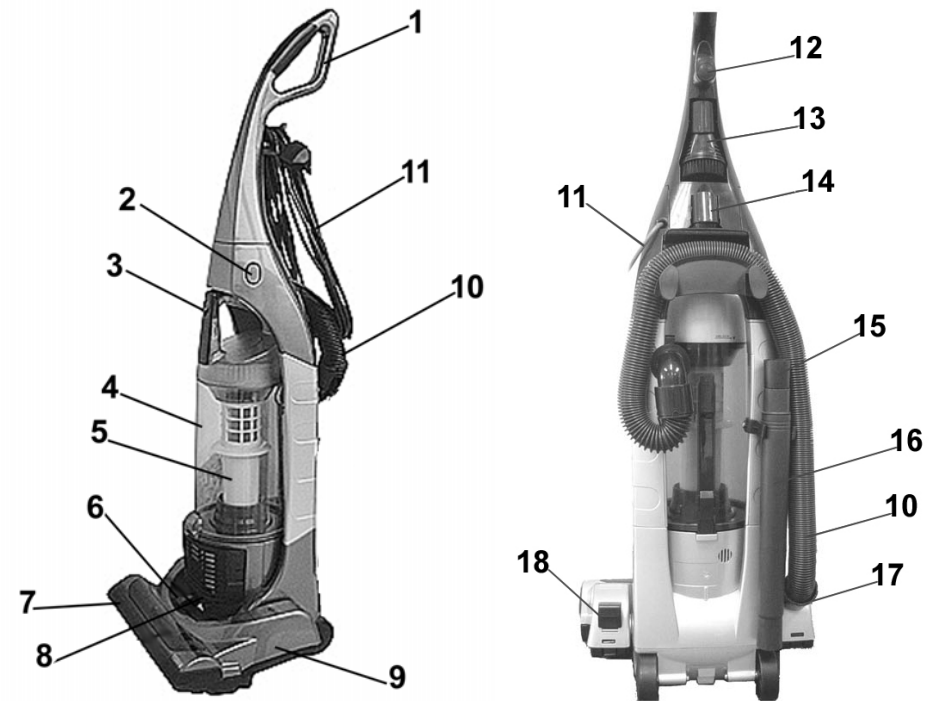

- | | |
|----------------------------|-------------------------------------|
| 1. Upper Handle | 10. Flexible Hose |
| 2. On/Off Switch | 11. Power Cord |
| 3. Dust Cup Release Button | 12. Quick Release Power Cord Holder |
| 4. Dust Cup | 13. Round Brush |
| 5. HEPA Filter Frame | 14. Upholstery Brush |
| 6. Carpet Height Selector | 15. Crevice Tool |
| 7. Furniture Guard | 16. Extension Tubes (x2) |
| 8. Head Light | 17. Hose Connector |
| 9. Motorized Power Head | 18. Carpet-to-Floor Selector |

Technical Specifications

Voltage: 120V., 60Hz.
Power: 12 Amps

Note: Illustrations may differ from actual unit.

OPERATING INSTRUCTIONS

Assembling Your Vacuum Cleaner

Note: Do not plug the power cord into an electrical outlet until the vacuum is fully assembled.

Handle Assembly

1. Carefully unpack all components, set aside packaging.
2. Lift vacuum body to upright position.
3. Remove the screw (1) that comes attached to the body.
4. From the rear of the vacuum, align the handle with groove and slide onto vacuum. If necessary, use thumb and finger pressure to slide handle into position.
5. Once handle is in place, secure the handle with the screws (2). (Fig. 1)

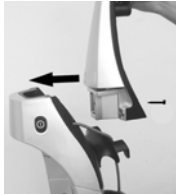

Fig. 1

Caution: Do not over tighten. Over tightening could strip the screw holes. Do not operate the vacuum without the handle screws in place.

Cord Assembly

1. Make sure that the quick release cord holder is in the upright position.
2. Remove the wire tie from the power cord.
3. Wrap the cord into place by wrapping it in a clockwise direction around the quick release cord holder and the lower cord holders. (Fig. 2)
4. Turn the quick release cord holder to the left or to the right to unwrap the power cord. (Fig. 2)

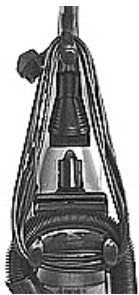

Fig. 2

Warning: Always make sure that the vacuum is turned off before unplugging.

Using the Attachments

1. Place vacuum in its upright position. Make sure that the vacuum cleaner is **NOT** plugged into the electrical outlet when adding or removing accessories.
2. **Turn the carpet height selector to the highest position and set the Carpet to Floor selector to the "Floor" position.**
3. Remove the hose connector from the rear of the unit and push in the desired attachment firmly onto the end of the hose.
4. If additional length is required, attach the extension tubes to the end of the hose and then attach the crevice tool, round brush or upholstery brush to the end of the extension tube.

Warning: Avoid tipping the vacuum or setting it on furniture, fringed area rugs or carpeted stairs while you are using the hose with the attachments. When using the unit to vacuum floors or with attachments, set the Carpet to Floor Selector to the "Floor" position. This will stop the beater brush from rotating. When vacuuming carpets, avoid leaving the vacuum in one place for an extended period of time, particularly on thick carpet.

Caution: Do **NOT** pull the vacuum cleaner around the room by the hose as it could tip over and cause damage. When using the attachments, do **NOT** over extend the hose length when reaching. Trying to reach beyond the hose reach could cause the vacuum to tip over.

How to Start

The upright vacuum can be used on multiple types of carpeting, bare floors or upholstery with attachments. When using the attachment tools such as the crevice tool, round brush or the upholstery brush, place the handle of the vacuum in the upright position.

1. Turn the quick release cord holder to either side 180° to release the power cord.
2. Plug the power cord into the electrical outlet.
3. Push the On/Off button to the "On" position to turn the vacuum on.
4. To release the handle, step on the power head and pull the handle back.
5. When using the attachments, the vacuum must be in the upright position. (Fig. 3)

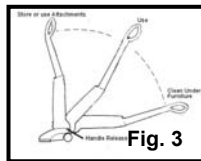

Fig. 3

OPERATING INSTRUCTIONS

6. Remove the belt cover (Fig. 22, #1)
7. Lift the right side of the brush bar first and then lift the left hand side. (Fig. 22 #2, #3)
8. Remove the brush bar from the power head. (Fig. 22, #4)
9. Carefully remove any belt residue that may exist in the belt area before replacing with a new belt.
10. Remove the worn or broken belt from the motor drive shaft.
11. Loop the new belt first over the motor drive shaft and then over the agitator pulley.

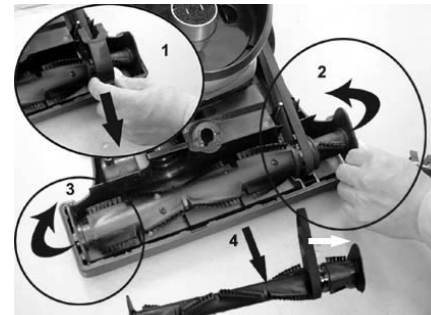

Fig. 22

12. Insert the right side of the brush bar in first by placing the end cap down into the slot and then do the same with the left side. Press firmly to make sure that each end is completely inserted.
13. Check to make sure that the belt is centered on the agitator pulley and that the brush bar turns.
14. Replace the belt cover.
15. Replace the power head cover and turn the unit over carefully.
16. Replace the lower plate, screwing in the four (4) outer screws first.
17. When screwing in the center screw, hold the carpet height adjustment knob from the outside and screw in the last screw.
18. Replace the lower plate.
19. Once the lower plate is attached, replace the base plate with the four (4) screws.

Changing the Headlight Bulb

Warning: To reduce the risk of electric shock, the power cord must be disconnected before removing the dust cup, HEPA filter, changing the filters or performing maintenance/trouble shooting checks.

1. Turn unit "Off" and unplug from wall outlet.
2. With a flat head screw driver, snap off the lens cover by pressing down on the two notches on the lens cover. (Fig. 23)
3. Lift off the head light lens.



Fig. 23

4. Remove the light bulb by pulling it out carefully.
5. Replace the new bulb by pushing it in.
6. Replace the head light lens by pushing it in so that it snaps back in place.

OPERATING INSTRUCTIONS

Cleaning the Dust Cup

Warning: To reduce the risk of electric shock, the power cord must be disconnected before removing the dust cup, HEPA filter, changing the filters or performing maintenance/trouble shooting checks.

The dust cup can be washed in lukewarm water. Do not use strong detergents. Ensure that the dust cup is fully dry before putting back on the vacuum cleaner.

(Fig. 18) Do not wash in dishwasher.



Fig. 18

Motor Thermostat

Important: This unit is equipped with a motor protective thermostat. If for some reason the vacuum cleaner should overheat, the thermostat will automatically turn the unit off. Should this occur:

- Push the On/Off button once.
- Disconnect the plug from the power source.
- Check the source of overheating problem. (i.e. clogged hose or filter)
- If clogged hose or filter is found, unclog the hose and replace the filters.
- Wait at least 45 minutes before attempting to reuse the vacuum.
- After unit has cooled down for 45 minutes, plug in the cleaner and push the On/Off button. The vacuum should start again.
- If the vacuum still does not start, contact **FANTOM** customer service at 1 (800) 275-9251.

Cleaning & Changing the Belt

Warning: To reduce the risk of electric shock, the power cord must be disconnected before removing the dust cup, HEPA filter, changing the filters or performing maintenance/trouble shooting checks.

Occasionally the power nozzle drive belt will require changing, the frequency will depend upon the amount of use your vacuum sees.

1. Turn the vacuum "Off" and unplug from power supply.
2. Turn the vacuum upside down on a flat level surface.
3. Using a Philips screw driver, remove the four (4) screws that attach the base plate to the lower plate. (Fig. 19)

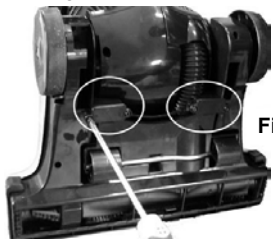

Fig. 19

4. After you have removed the base plate, remove the remaining five (5) screws from the lower plate using a Philips screw driver. (Fig. 20)

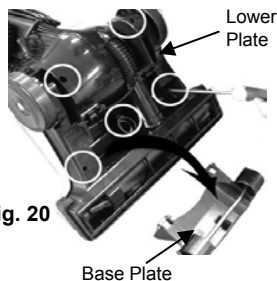

Fig. 20

5. With the unit still lying down, turn the unit over and lift the power head cover starting from the back of the power head. (Fig. 21)



Fig. 21

OPERATING INSTRUCTIONS

Carpet Height Selector

This upright vacuum can be used on multiple types of carpeting, bare floors or upholstery with attachments.

To select a pile height setting:

1. Turn vacuum cleaner "Off".
2. Select a pile height setting by sliding the carpet height selector to the desired setting. (Fig. 4)

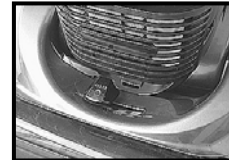

Fig. 4

Suggested Pile Height Setting:

You may need to raise the height of the vacuum to make some jobs easier, such as scatter rugs and longer pile carpets. Suggested settings are:



HIGH: shag carpet, long pile, plush scatter rugs, tools

MED: medium to long pile

LOW: short to medium pile, bare floors

FLOOR: very low pile, bare floors

Place unit in "HIGH" setting when using attachments to prevent possible floor damage. Always set the Carpet to Floor selector to "Floor" setting when using the accessories. (Fig. 5)

Attention: Special care is required when vacuuming certain types of carpet or floor covering. Always check the carpet or floor covering manufacturer's recommended cleaning instructions before vacuuming.



Fig. 5

Removing & Emptying Dust Cup

Warning: To reduce the risk of electric shock, the power cord must be disconnected before removing the dust cup, dust cup filter, changing the filters or performing maintenance/trouble shooting checks.

The "Dust Cup" must always be emptied when the dirt level reaches the "FULL" line on the dust cup. To remove the dust cup from the vacuum:

1. Press down on the dust cup release button that is located on the handle of the dust cup. (Fig. 6)
2. Holding the dust cup from the handle, pull the dust cup out from the vacuum. (Fig. 7)
3. To empty the dust cup, hold it by the handle over a garbage can and press on the trap door release button to empty. (Fig. 8)



Fig. 6



Fig. 7



Fig. 8

Cleaning the HEPA Dust Cup Filter

IMPORTANT, Please Note : The Rinseable "TapClean" HEPA Dust Cup Filter will stop most of the tiniest dust particles and airborne allergens from re-entering the air you breathe. In fact, it stops 99.97% of all particles as small as 0.3 microns - many times smaller than a human hair!!! Because of this incredible filtration performance, the HEPA Dust Cup Filter will quickly accumulate many fine dust particles inside the white filter folds that are difficult to see but which will eventually block or reduce your suction power - if not cleaned properly. Clean the HEPA Filter after each use as described in this section.

1. To remove the HEPA filter, remove the dust cup from the unit.
2. To remove the dust cup cover, hold the cover by the handle, turn counter clockwise and lift the cover off. (Fig. 9)
3. Remove the HEPA Rinseable "Tap Clean" filter from the dust cup. (Fig. 10)
4. Remove the filter ring that is around the HEPA filter. Vigorously "TapClean" the HEPA dust cup filter on a hard surface until no more dust is observed falling out. (Fig. 11) The HEPA filter may also be washed by running it under the tap allowing the water to run on the dirty side. (Fig. 12) We recommend washing it once a month or when suction appears reduced. Always allow 24 hours for air drying before replacing into the vacuum.



Fig. 9



Fig. 10



Fig. 11



Fig. 12

Please Note: The white material in the HEPA filter will discolor over time - This is NORMAL and will NOT affect the performance of the filter.

Warning: Always empty the dust cup and clean the HEPA dust cup filter before each use and during prolonged usage. Never over fill the dust cup - remove dirt and clean the HEPA dust cup filter each time the dust cup is emptied during prolonged usage or risk motor damage.

Cleaning the HEPA Filter Frame

1. Before replacing the HEPA filter in the HEPA Filter frame, you can (should) rinse the frame in lukewarm water by just running it under the tap to remove any dust that is adhering to the frame. (Fig. 13) Do NOT place in dishwasher.

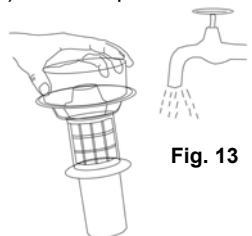

Fig. 13

2. Make sure that the filter frame is completely dry before replacing into the dust cup. Always air dry.

Cleaning the Filter Ring

1. Around the HEPA filter there is a filter ring. This is washable in lukewarm water. (Fig. 14) To remove the filter ring, slide it off the HEPA filter.
2. We recommend washing the filter ring when you are washing your HEPA filter. Always allow the filter ring to air dry for 24 hours before replacing onto the HEPA filter. Never run the vacuum without all the filters in place.

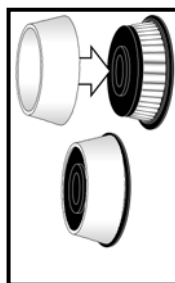

Fig. 14

Note: This is a washable filter, but we recommend replacing it every three (3) months.

Cleaning the Secondary Filter

1. Underneath the HEPA filter there is a secondary filter. This is washable in lukewarm water. (Fig. 15) We recommend washing it when you are washing your HEPA filter. Always allow the secondary filter to air dry for 24 hours before replacing into the vacuum. Never run the vacuum without the secondary filter in place. Fig. 15



Changing & Cleaning the Pre-Motor Filter

Warning: To reduce the risk of electric shock, the power cord must be disconnected before removing the dust cup, HEPA filter, changing the filters or performing maintenance/trouble shooting checks.

The pre-motor filter is located in the vacuum underneath the dust cup. Please note that this filter is a washable filter and can be cleaned by rinsing under lukewarm water. Always allow the pre-motor filter to air dry for 24 hours before replacing in the vacuum. Do not use a hair dryer to dry it. Air dry only. To remove the pre-motor filter:

1. Remove the dust cup. (See instructions on page 5 for removing the dust cup).
2. Hold the Pre-Motor filter cover and turn counter-clockwise to unlock and lift to remove. (Fig. 16)
3. Remove the pre-motor filter and clean by rinsing under lukewarm water.
4. After air drying for 24 hours, replace in the vacuum.
5. To replace the pre-motor filter cover, insert the locking lugs into the lug holes and turn clockwise to lock.

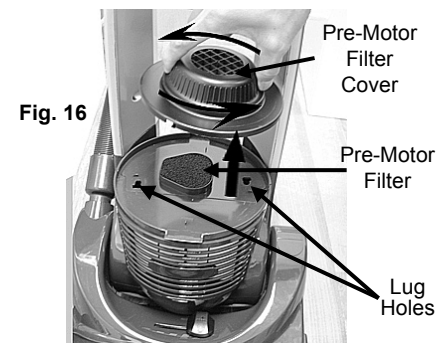

Fig. 16

Changing & Cleaning the Exhaust Filter

Warning: To reduce the risk of electric shock, the power cord must be disconnected before removing the dust cup, HEPA filter, changing the filters or performing maintenance/trouble shooting checks.

The exhaust filter is located on the front of the unit below where the dust cup is. To remove the exhaust filter, you must first remove the filter cover.

1. Check the exhaust filter frequently and replace with new filters when dirty.
2. Remove the exhaust filter cover. (Fig. 17)
3. Remove the exhaust filter.
4. Rinse in lukewarm water and let the filter air dry for 24 hours before re-installing into the vacuum. Do not use a washing machine to rinse the filter. Do not use a hair dryer to dry the filter. Air dry only. Never operate the vacuum without ALL the filters in place.
5. When the filter is dry, replace into the vacuum and replace the filter cover.

Note: A severely soiled or clogged filter should be thoroughly washed with fresh tepid water. A mild detergent may be used if required.

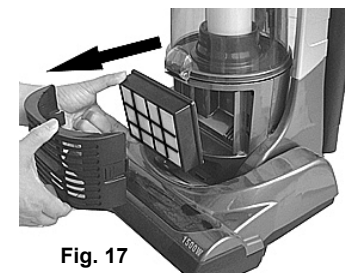

Fig. 17

Free Manuals Download Website

<http://myh66.com>

<http://usermanuals.us>

<http://www.somanuals.com>

<http://www.4manuals.cc>

<http://www.manual-lib.com>

<http://www.404manual.com>

<http://www.luxmanual.com>

<http://aubethermostatmanual.com>

Golf course search by state

<http://golfingnear.com>

Email search by domain

<http://emailbydomain.com>

Auto manuals search

<http://auto.somanuals.com>

TV manuals search

<http://tv.somanuals.com>