

EVINRUDE®

Johnson®

GENUINE PARTS

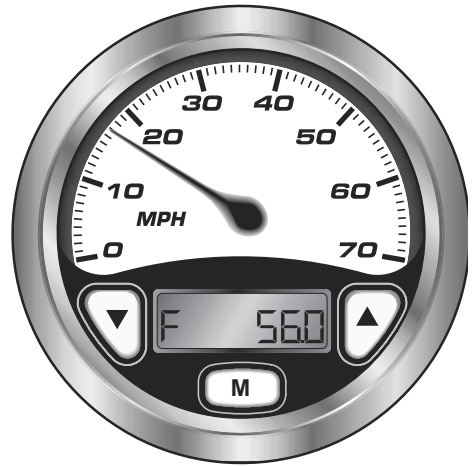

Owner's Manual

SystemCheck® Commander™

Speedometer/ Depth Sounder

- Digital Speedometer with Analog Appearance
- Digital displays for
 - Depth in Feet, Meter, or Fathoms
 - Shallow or Deep Water Alarms
 - Alarms are Audible and Visual
 - Programmable Keel Offset
 - Trip Log

Installation

Two Wire Connector	Page 1
Four Wire Connector	Page 1
Figure 1 Installation Diagram	Page 1

Operation

Speedometer	Page 2
-------------	--------

Description

Trip Log	Page 2
Reset	Page 3
Units	Page 3
Depth Sounder	Page 3
Shallow Alarm	Page 4
Deep Alarm	Page 4
Keel Offset	Page 4
Units	Page 4
Loss of Signal	Page 5
Calibration	Page 5

Figure 2 Speedometer LCD Display Modes	Page 6
Quick Reference Guide	

Set-Up Mode

Speedometer Scale Selection	Page 7
-----------------------------	--------

Figure 3 Set- Up Mode	Page 7
Quick Reference Guide	

Figure 4 - HN0353 , 4 Wire Connection Wire Diagram	Page 8
---	--------

Figure 5 - HN0357 , 2 Wire Connection Wire Diagram	Page 9
---	--------

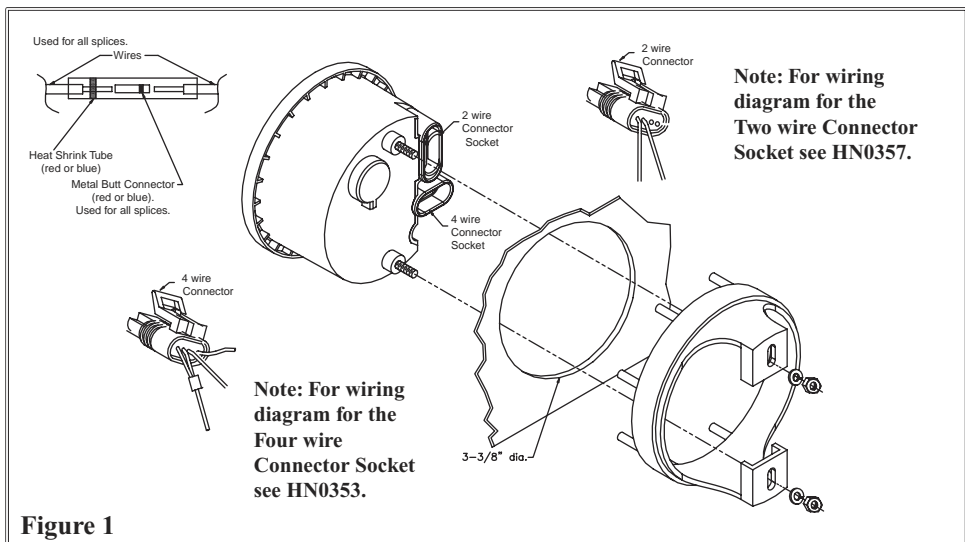

Figure 1

Use with:
SystemCheck® Commander™
Speedometer with Depth Sounder

Installation:

CAUTION: Disconnect the battery during installation. Tighten nuts on the backclamp only slightly more than you can tighten with your fingers. **Six inch-pounds** of torque are sufficient. Over-tightening could result in damage to the instrument and may void your warranty.

Mounting

1. Cut a 3-3/8" diameter hole in the dash and mount the gauge with the backclamp supplied.

The butt connectors have a heat activated waterproofing. Once the butt connections have been crimped, slowly apply heat with a heat gun until you see sealant coming out of the connector ends. It is recommended to wrap the connections together with electrical tape for further protection.

Two Wire Connector Socket

Follow the wiring diagram at the end of this manual for wiring connections. (See Diagram HN0357, **Figure 4**, page 8).

Four Wire Connector Socket

Connections for Speed input, Ignition and Ground. Follow the wiring diagram at the end of this manual for wiring connections. (See Diagram HN0353, **Figure 5**, page 9).

Operation

Speedometer

The speedometer is a digital instrument with the appearance of an analog instrument. The speedometer is designed to be operated from a “paddle wheel” sensor. A microprocessor controlled stepper motor moves the pointer to display boat speed using a linear dial.

The microprocessor and stepper motor provide excellent accuracy. Variations in the operation of the “paddle wheel” sensor are however fairly common. These variations may be caused by the mounting location of the “paddle wheel” on the hull, which affects water flow characteristics, or turbulence and air bubbles in the area of the “paddle wheel”. Therefore, calibration of the speedometer may be required and is easily accomplished by using the Trip Log display or the pointer.

Description

The SystemCheck® Commander™ Speedometer has three push buttons;

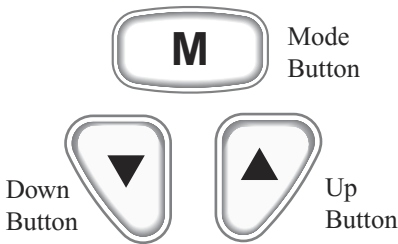

The “Mode” button is used to change the function of the LCD display and to access sub menus and adjustable settings. The “Down” and “Up” buttons are used to modify the settings.

In normal operation mode, pressing the “Mode” button for a short period of time causes the display to cycle between the Depth Sounder display and the Trip Log

display. Pressing and holding the “Mode” button causes the display to change to the “settings” sub menu (see Figure 2, page 6).



When the settings menus have been selected, pressing the “Mode” button for a short period of time causes the display to cycle through the setting options. Within each setting selection, pressing the “Down” and “Up” buttons causes the affected setting to change. The microprocessor will automatically record the new settings as you adjust them.



When in a setting menu, pressing and holding the “Mode” button returns to the main function.



Trip Log



The Trip Log is similar to the trip odometer in an automobile. The distance traveled, as recorded by the speedometer “paddle wheel”, is displayed.



The Trip Log may be reset to zero, the units of measure changed, or the

calibration adjusted using the sub menus.

Pressing and holding the “Mode” button while the Trip Log is displayed will change the display to the “settings” menu (see **Figure 2**, page 6).



Trip Log “Settings” Menu

There are three items in the Trip Log “Settings” Menu: Reset, Units, and Calibration. Briefly pressing the “Mode” button cycles through the menu items.



The microprocessor will automatically record the new settings as you adjust them.

Reset



Pressing the “Up” and “Down” button resets the Trip Log to zero.



Units



Pressing the “Up” or “Down” button cycles the units of measurement for the Trip Log between miles (MI) and nautical

miles (NM).

Miles



Nautical Miles



Calibration



This menu item is used to simultaneously adjust the calibration of the Speedometer and the Trip Log. Two methods of calibration are possible. These methods will be discussed in the Calibration Section.

Depth Sounder

The Depth Sounder displays the depth of the water under the boat.



The depth can be displayed in feet, meters, or fathoms. Audible and visual alarms can be set to warn of shallow or deep water conditions. A “keel offset” setting allows the operator to adjust for the difference in the location of the Depth Sounder transducer compared to the deepest part of the boat’s hull. The various settings are accessed by pressing and holding the “Mode” button while the Depth Sounder is displayed (see **Figure 2**, page 6).





Depth Sounder “Settings” Menu

There are four items in the Depth Sounder “Settings” Menu: Shallow Alarm, Deep Alarm, Keel Offset, and Units. Briefly pressing the “Mode” button cycles through the menu items.



The microprocessor will automatically record the new settings as you adjust them.

Shallow Alarm



Pressing the “Up” or “Down” button changes the setting for the Shallow Alarm.



Setting the Shallow Alarm to zero turns off the alarm. To have this alarm indicate the depth of water under the deepest part of the hull, the Keel Offset must be properly set.

Deep Alarm



Pressing the “Up” or “Down” button changes the setting for the Deep Alarm.

Setting the Deep Alarm to zero turns off the alarm.



Keel Offset



Pressing the “Up” or “Down” button changes the setting for the Keel Offset.



Negative numbers indicate that the Depth Sounder transducer is located ABOVE the deepest part of the hull (typical). Allow for worst case boat loading when adjusting the Keel Offset as this setting affects the Shallow Alarm.

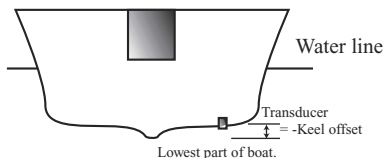

Units



Pressing the “Up” or “Down” button cycles the units of measurement for the Depth Sounder between



feet (FT),



meters (m),



and fathoms (FA).



Loss of Signal

When the Commander™ loses signal from the transducer, the LCD display will flash the following:

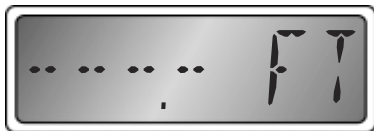

Calibration

Speedometer / Distance Traveled

Calibration is done in the Trip Log “settings menu”. (See Figure 2)

Calibrate

Press the “Mode” button to display the Trip Log.



Quickly press the “Mode” button three (3) times to select and enter the Calibrate “settings menu”.



There are two methods of calibration;

1) A GPS or radar gun can be used to obtain a fixed speed. While holding the boat at the selected speed press the “Up” or “Down” buttons to adjust the speedometer pointer reading to match the GPS or radar gun indicated speed.



2) The Trip Log can be set to zero and then a course of known distance run, such as between two buoys or by using a GPS. At the end of the run access the Calibration menu item.

Press the “Up” or “Down” buttons to adjust the recorded Trip Log distance to match the known distance. This will calibrate both Trip Log and the Speedometer.



Quick Reference Guide

Speedometer LCD Display Modes

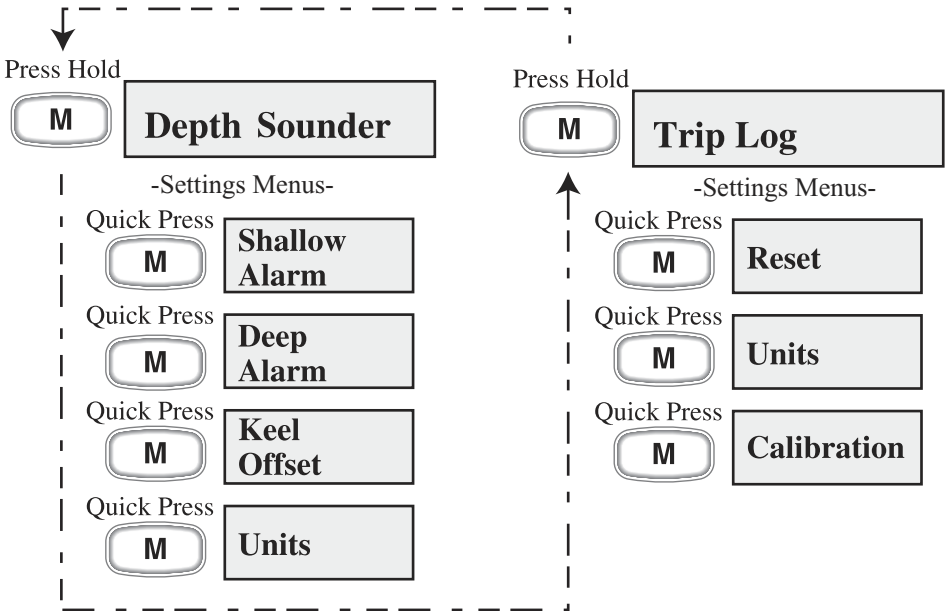

Figure 2

Setup Mode

The speedometer full scale deflection setting can be changed using the Setup Mode (see Figure 1). Use this option only if you have reason to believe that your setting is wrong. Setting an incorrect value in this menu can result in extremely inaccurate performance of the speedometer. To access the Setup Mode, **press and hold** both the “Up” and “Down” buttons while turning on the instrument.



The display will show “*SETUP*”.



Briefly pressing the “Mode” button will change the display to the setting menu.



The “Up” and “Down” buttons are used to modify the setting.



The microprocessor will automatically record the new setting as you modify it.

Pressing and holding the “Mode” button sets the instrument to normal operation.



Speedometer Full Scale Selection



Refer to Figure 3 (below) for an explanation of each of the speedometer

full scale selections.

This is normally a factory setting that needs no adjustment. The setting adjusts the “full scale” operating range of the speedometer to match the dial on the instrument. Using the “Up” and “Down” buttons,



adjust the setting to match the maximum reading on the speedometer dial: 50 or 70 MPH.

Quick Reference Guide

Set-Up Mode

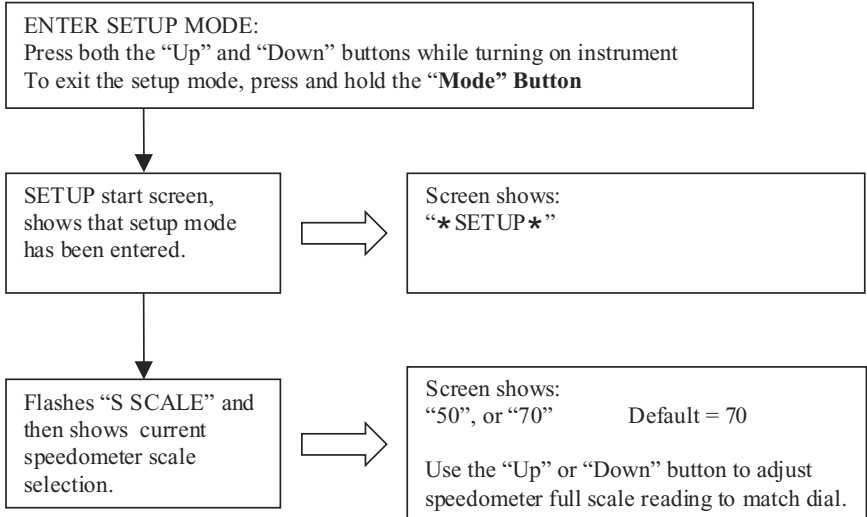

Figure 3

Figure 4

Harness HN0353

Four Wire Connector

To Commander™

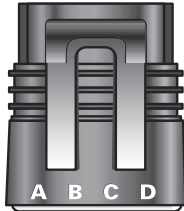

Small Plug (CN0082)

Pin A	Purple	+12 Ignition Power
Pin B	Purple	+12 Ignition Power
Pin C	Black	Ground
Pin D	White/Blue	Speedometer Input

ECR 1903 12/21/01

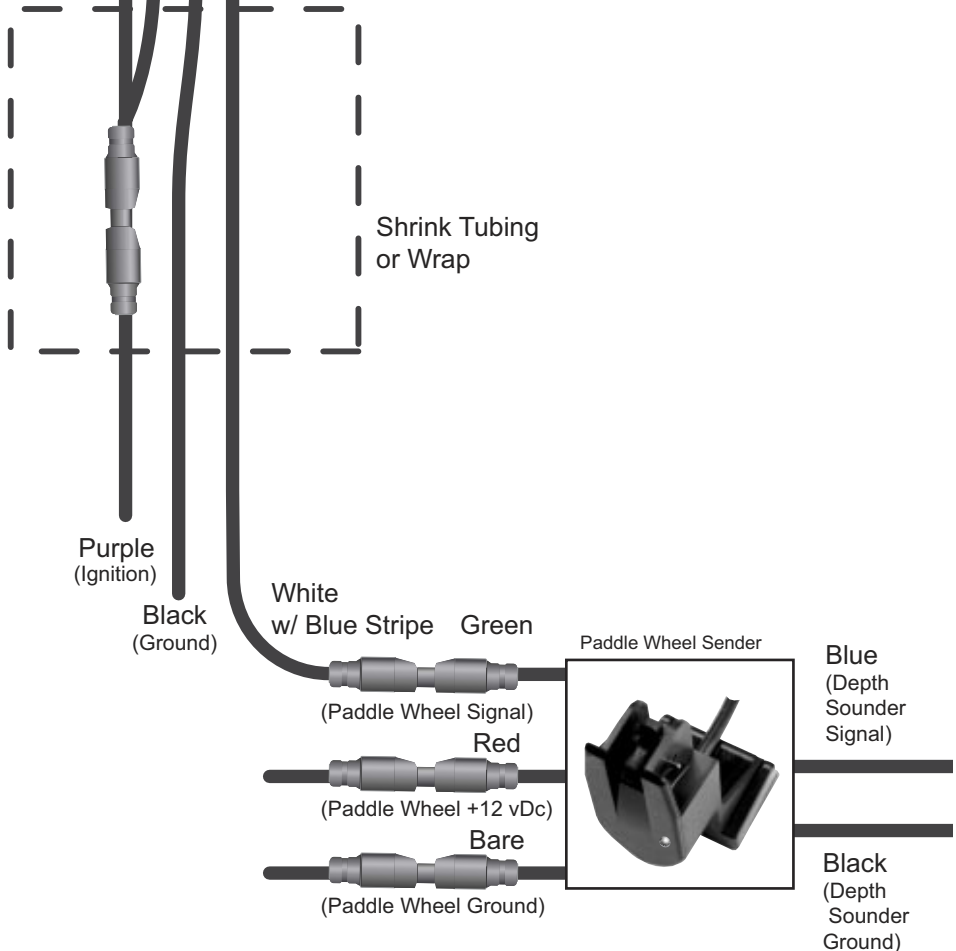
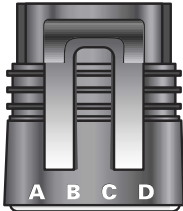

Figure 5 Harness HN0357 Two Wire Connector

To Commander™



Small Plug(CN0082)

Pin A	Blue	Depth Sounder Signal
Pin B	Black	Depth Sounder Ground
Pin C		Not Used
Pin D		Not Used

ECR 1903 12/21/01

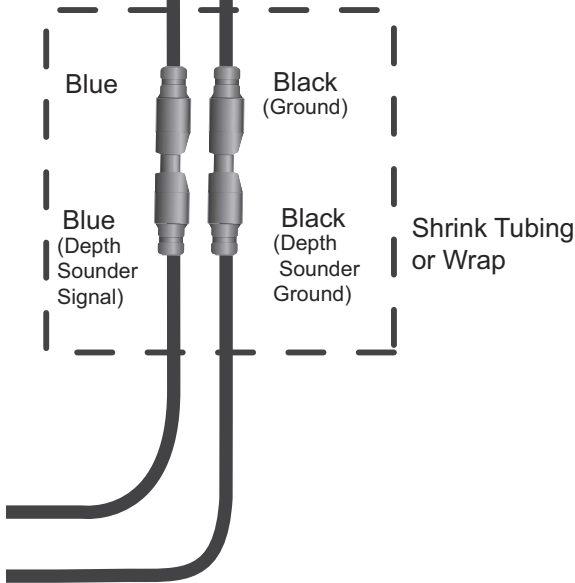

Notes:

Free Manuals Download Website

<http://myh66.com>

<http://usermanuals.us>

<http://www.somanuals.com>

<http://www.4manuals.cc>

<http://www.manual-lib.com>

<http://www.404manual.com>

<http://www.luxmanual.com>

<http://aubethermostatmanual.com>

Golf course search by state

<http://golfingnear.com>

Email search by domain

<http://emailbydomain.com>

Auto manuals search

<http://auto.somanuals.com>

TV manuals search

<http://tv.somanuals.com>