

FESTOOL

Kapex® KS 120

Miter Saw



Sliding Dual Compound Miter Saw Supplemental User's Manual



WARNING *To reduce the risk of serious or fatal injury, read and understand all safety precautions and instructions in this manual before using this tool.*

Limited Warranty

30 Day Money Back Guarantee

We are so confident that you will thoroughly enjoy our tools, that we offer a 30 day money back guarantee. If you are not

completely satisfied, your full purchase price will be refunded, excluding all freight charges.

1 + 2 Limited Warranty

Festool USA offers a 3-year limited warranty, one of the longest in the industry. This warranty is valid on the pre-condition that the tool is used and operated in compliance with the Festool

operating instructions. Festool USA warrants that the specified tool will be free from defects in materials and workmanship for a term of 3 years from the date of purchase.

Conditions of 1 + 2 Limited Warranty

You are entitled to a free extended limited warranty (1 year + 2 years = 3 Years) for your Festool power tool. Festool USA is responsible for all shipping costs during the first year of the warranty. During the second and third year of the warranty, the customer is responsible for shipping the tool to Festool. Festool will pay for return shipping to the customer using UPS Ground Service. All warranty service is valid 3 years from the date of purchase on your receipt or invoice.

Excluded from the coverage under this warranty are: normal wear and tear, damages caused by misuse, abuse, or neglect; damage caused by anything other than defects in material and workmanship. This warranty does not apply to accessory items such as circular saw blades, drill bits, router bits, jigsaw blades, sanding belts, and grinding wheels. Also excluded are "wearing parts," such as carbon brushes, lamellas of air tools, rubber collars and seals, sanding discs and pads, batteries, and Festool gear (hats and t shirts).

The obligations of Festool USA in its sole discretion under this warranty shall be limited to repair or replacement or a refund of the purchase price for any Festool portable power tool that is found to have a defect in materials or workmanship during the

warranty period. FESTOOL USA SHALL NOT BE LIABLE FOR ANY CONSEQUENTIAL, INCIDENTAL OR SPECIAL DAMAGES REGARDLESS OF THE THEORY OF LAW ON WHICH THE CLAIM IS BASED. ALL WARRANTIES IMPLIED BY STATE LAW, INCLUDING THE IMPLIED WARRANTIES OR MERCHANTABILITY AND FITNESS FOR A PARTICULAR PURPOSE ARE HEREBY LIMITED TO THE DURATION OF THREE YEARS.

Some states in the U.S. and some Canadian provinces do not allow the limitations on how long an implied warranty lasts, so the above limitation may not apply to you. This warranty gives you specific legal rights, and you may also have other rights that vary from state to state in the U.S. and from province to province in Canada.

With the exception of any warranties implied by state or province law as limited above, the foregoing express limited warranty is exclusive and in lieu of all other warranties, guarantees, agreements, and similar obligations of Festool USA. Festool USA makes no other warranty, express or implied, for Festool portable power tools. No agent, representative, distributor, dealer, or employee of Festool USA has the authority to increase or otherwise change the obligations or limitations of this warranty.

Repairs

If your Festool power tools require repair, you must contact our Service Department at (800) 554-8741 for authorization and address details. No collect shipments will be accepted. No Festool

hats, t-shirts or other wearables may be returned. Also contact our Service Department at the telephone number listed above if you have any questions about warranty claim procedures.

Returns

If you need to return your Festool tools for any reason, please return it to the dealer from which you originally bought the tool.

Liability Statement

This product has been built to the high standards of Festool. Please do not attempt to operate or repair this equipment without adequate training. Any use, operation, or repair in contravention of this document is at your own risk. By acceptance of this system you hereby assume all liability consequent to your use or

misuse of this equipment. Festool USA assumes no liability for incidental, special, or consequential damage of any kind. Equipment specifications, applications, and options are subject to change at the sole discretion of Festool USA without notice.

Proprietary Notice

All drawings and information herein are the property of Festool, TTS Tooltechnic Systems AG & Co. KG. All unauthorized use and reproduction is prohibited.

Written and Illustrated by Rick Christopherson.

© 2008 TTS Tooltechnic Systems AG & Co. KG

All rights reserved. Printed in the United States of America and Germany.

Festool USA is a division of Tooltechnic Systems, LLC.

Festool is a trademark and service mark of TTS Tooltechnic Systems AG & Co. KG

Kapex and FastFix are registered trademarks of TTS Tooltechnic Systems AG & Co. KG

MiterFast is a trademark of TTS Tooltechnic Systems AG & Co. KG

www.festoolusa.com





Contents

Limited Warranty	2	Power Trigger and Plunge Release	11
30 Day Money Back Guarantee	2	Using the Hold Down Clamp	12
1+2 Limited Warranty	2	Setting the Miter Angle	12
Conditions of 1+2 Limited Warranty	2	Setting the Bevel Angle	13
Repairs	2	Using the Auxiliary Fence	13
Returns	2	Setting the Depth Limit	14
Liability Statement	2	Using the Tall Miter Latch	14
Proprietary Notice	2	Using the MiterFast Tool	15
About This Manual	3	Using the Bed Extensions and Crown Stops	16
Tool Symbols	3	Cutting Techniques	17
General Power Tool Safety Warnings	4	Miter Cuts	18
Work Area Safety	4	Bevel Cuts	18
Electrical Safety	4	Depth Limited (Dado/Half-Lap) Cuts	19
Personal Safety	4	Compound Miter Cuts	20
Power Tool Use and Care	4	Calculating Compound Angles	21
Service	5	Compound Angle Calculator	21
Specific Safety Rules for Miter Saws	5	Crown Moulding	22
Respiratory Exposure Safety Warnings	5	Adding Auxiliary Fence Faces	23
Tool Description	5	Making a Zero-Clearance Insert	23
Technical Specifications	5	Calibration and Adjustment	24
Intended Use	6	Calibrating the Miter Angle	24
Functional Description	6	Calibrating the Bevel Angle	26
Setup	8	Calibrating the Lasers	28
Setting Up a New Miter Saw	8	Troubleshooting	29
Changing Sawblades	9	Optional Accessories	30
Transporting the Saw	10	Sawblades	30
Dust Extraction	10	MFT/3-Kapex Table	31
Basic Operation	11	Bolt Down (Clamping) Kit	31
Setting the Motor Speed	11	Crown Stop	31
Using the Laser Guides	11		

About This Manual

Save These Instructions

It is important for you to read and understand this manual. The information it contains relates to protecting YOUR SAFETY and PREVENTING PROBLEMS. The symbols below are used to help you recognize this information.

	WARNING!	Indicates a potentially hazardous situation which, if not avoided, could result in death or serious injury.
	CAUTION!	Indicates a potentially hazardous situation which, if not avoided, could result in minor or moderate injury.
	Laser Radiation	This symbol is used on the machine and in this manual to signify the possibility of laser radiation.
	NOTICE:	Indicates a potential situation which, if not avoided, can result in property damage or damage to the tool.
	Note:	Indicates information, notes, or tips for improving your success using the tool.

Tool Symbols

V	Volts
W	Watts
Hz	Hertz
~	Alternating Current (AC)
n _o	No-load Speed
∅	Diameter
	Class II Double Insulated



Designated Danger Zone.
Avoid positioning hands, fingers, or arms in the area designated by this symbol.

General Power Tool Safety Warnings



WARNING! Read all safety warnings and instructions. Failure to follow the warnings and instructions may result in electric shock, fire, and serious or fatal injury.



CAUTION! Laser Radiation. This product contains a Class II laser. Do not look directly into the laser beam. Power ≤ 1mW, Wavelength: 640 to 660 nm

Save all warnings and instructions for future reference.

Work Area Safety

- ▶ **Keep your work area clean and well lit.** Cluttered or dark work areas invite accidents.
- ▶ **Do not operate power tools in explosive atmospheres, such as in the presence of flammable liquids, gases, or dust.** Power tools create sparks which may ignite the dust or fumes.
- ▶ **Keep children and bystanders away while operating a power tool.** Distractions can cause you to lose control.

Electrical Safety

- ▶ **Power tool plugs must match the outlet. Never modify the plug in any way. Do not use any adapter plugs with power tools.** Unmodified plugs and matching outlets will reduce risk of electric shock.
- ▶ **Avoid body contact with earthed or grounded surfaces such as pipes, radiators, ranges and refrigerators.** There is an increased risk of electric shock if your body is earthed or grounded.
- ▶ **Do not expose power tools to rain or wet conditions.** Water entering a power tool will increase the risk of electric shock.
- ▶ **Do not abuse the cord. Never use the cord for carrying, pulling, or unplugging the power tool. Keep cord away from heat, oil, sharp edges or moving parts.** Damaged or entangled cords increase the risk of electric shock.
- ▶ **When operating a power tool outdoors, use an extension cord suitable for outdoor use.** Use of a cord for outdoor use reduces the risk of electric shock.
- ▶ **If operating a power tool in a damp location is unavoidable, use a ground fault circuit interrupter (GFCI) protected supply.** Use of a GFCI reduces the risk of electric shock.
- ▶ **Never use an extension cord that is damaged, including cuts, exposed wires, or bent/missing prongs.** Damaged extension cords increase the risk of fire or electric shock.
- ▶ **Use only extension cords rated for the purpose.**
- ▶ **Use only extension cords rated for the amperage of this tool and the length of the cord.** Using too small of an extension cord can cause the cord to overheat.

Extension Cord Ratings	
Cord Length	Size (AWG)
<25 Ft.	14
25-50 Ft.	12
50-100 Ft.	10
>100 Ft.	Not recommended

Personal Safety

- ▶ **Stay alert, watch what you are doing, and use common sense when operating a power tool. Do not use a power tool while tired or under the influence of drugs, alcohol, or medication.** A moment of inattention while operating power tools may result in serious personal injury.
- ▶ **Use personal protective equipment. Always wear eye protection.** Protective equipment such as dust mask, non-skid safety shoes, hard hat, or hearing protection used for appropriate conditions will reduce the risk of personal injuries. (Eye protection must comply with ANSI Z87.1)
- ▶ **Prevent unintentional starting. Ensure the switch is in the off-position before connecting to power source, picking up, or carrying the tool.** Carrying power tools with your finger on the switch or energizing power tools that have the switch on invites accidents.
- ▶ **Remove adjusting key or wrench before turning the power tool on.** A wrench or a key that is left attached to a rotating part of the tool may result in personal injury.
- ▶ **Do not overreach. Keep proper footing and balance at all times.** This enables better control of the tool in unexpected situations.
- ▶ **Dress properly. Do not wear loose clothing or jewelry. Keep your hair, clothing, and gloves away from moving parts.** Loose clothes, jewelry, or long hair can be caught in moving parts.
- ▶ **If devices are provided for the connection of dust extraction and collection facilities, ensure these are connected and properly used.** Use of dust collection can reduce dust-related hazards.

Power Tool Use and Care

- ▶ **Do not force the power tool. Use the correct power tool for your application.** The correct power tool will do the job better and safer at the rate for which it is designed.
- ▶ **Do not use the power tool if the switch does not turn it on and off.** Any power tool that cannot be controlled with the switch is dangerous and must be repaired.
- ▶ **Disconnect the plug from the power source before making any adjustments, changing accessories, transporting, or storing the tool.** Such preventive safety measures reduce the risk of starting the tool accidentally.
- ▶ **Store idle tools out of reach of children and do not allow persons unfamiliar with the power tool or these instructions to operate the power tool.** Power tools are dangerous in the hands of untrained users.
- ▶ **Maintain power tools. Check for misalignment or binding of moving parts, breakage of parts and any other condition that may affect the power tool's operation. If damaged, have the power tool repaired before use.** Many accidents are caused by poorly maintained power tools.
- ▶ **Keep cutting tools sharp and clean.** Properly maintained tools with sharp cutting edges are less likely to bind and are easier to control.
- ▶ **Use the power tool, accessories, and tool bits etc. in accordance with these instructions, taking into account the working conditions and the work to be performed.** Use of the power tool for operations different from those intended could result in a hazardous situation.

Service

- ▶ To reduce the risk of serious or fatal injury, never open the motor housing. Have your power tool serviced only by a qualified repair person using only identical replacement parts.
- ▶ Any repairs to the laser must be carried out by the laser manufacturer or by an authorized agent of the laser manufacturer. Never attempt to replace the laser on this tool with a different type of laser.

Specific Safety Rules for Miter Saws

- ▶ To reduce the risk of serious or fatal injury, never alter or misuse the power tool.
 - ▶ Be certain the miter saw is mounted or securely placed on a level, firm work surface before using. A level and firm work surface reduces the risk of the miter saw becoming unstable or tipping.
 - ▶ Make sure all controls and clamping handles are secured before starting any operation. Unsecured clamps or adjustment handles can cause the saw and/or workpiece to move unexpectedly.
 - ▶ Always unplug the saw before servicing or changing the sawblade.
 - ▶ Never remove or disable the blade guard. Inspect the blade guard before use. Repair or replace a damaged or improperly functioning blade guard before further use.
 - ▶ Keep hands out of the path of the sawblade. Never cross your hand over intended line of cutting. Supporting the workpiece "cross handed" e.g. holding the left side of the workpiece with your right hand, is very dangerous.
 - ▶ Do not reach in back of the moving saw blade with either hand to remove wood scraps, hold down or support the workpiece, or for any other reason. The proximity of the spinning saw blade to your hand may not be obvious and you may be seriously injured.
 - ▶ Use clamps to support workpiece whenever possible. Do not use this saw to cut pieces that are too small to be securely clamped.
 - ▶ Clamp the offcut side of the workpiece when using a length stop. An unsecured offcut can bind between the length stop and the saw blade.
 - ▶ If securing the workpiece by hand, you must always keep hands outside of "No Hand" area as marked with a symbol on the base. Your hand, if placed inside the "No Hands" region, can easily slip or be pulled into the blade.
 - ▶ Support long workpieces to prevent them from tipping.
- A tipping workpiece can lift up and contact the spinning sawblade, or bring the operator's hand upward into the blade.
- ▶ For proper control, never "pull" the saw through the cut, always chop or push cut. See page 17 of this manual.
 - ▶ Cut only one workpiece at a time. Multiple workpieces cannot be adequately clamped or braced and may bind on the blade or shift during cutting.
 - ▶ Keep workpieces firmly against the rear fence when cutting. Never cut workpieces that do not lay flat or are curved in any way. A curved workpiece can be grabbed by the blade and propelled back against the fence.
 - ▶ Inspect workpieces for nails or foreign objects. Make sure there are no tools or foreign objects on the saw.
 - ▶ Do not cut round stock unless it is clamped in such a way as to prevent rotation. Round stock will tend to roll while it is being cut.
 - ▶ Use only sawblades recommended by the manufacturer and designed for use with the saw, with a 30mm arbor bore, a 260mm diameter, and a maximum thickness of 2mm. Be sure that the speed marked on the saw blade is at least equal to the speed marked on the saw. Do not use high speed steel saw blades.
 - ▶ Select the correct saw blade for the material to be cut. Do not use the saw to cut materials other than those recommended by the manufacturer. Never force the tool or attachment to do a job for which it was not designed.
 - ▶ Never use this saw for cutting ferrous metals.
 - ▶ Never use saw blades that are damaged or deformed. Never use a dull sawblade. A dull sawblade places undue stress on the saw and the workpiece and can increase the risk of kickback.
 - ▶ Make sure the sawblade is securely installed and is not backward. The arrow on the blade should match the direction of the arrow marked on the tool.

Respiratory Exposure Safety Warnings

Substantial or repeated inhalation of dust and other airborne contaminants, in particular those with a smaller particle size, may cause respiratory or other illnesses. Various dusts created by power sanding, sawing, grinding, drilling and other construction activities contain chemicals or substances known (to the State of California and others) to cause cancer, birth defects or other reproductive harm. Some examples of these chemicals/substances are:

- ▶ lead from lead-based paints;
- ▶ crystalline silica from bricks, cement, and other masonry products;

- ▶ arsenic and chromium from chemically-treated lumber; and
- ▶ some wood dusts, especially from hardwoods, but also from some softwoods such as Western Red Cedar.

The risk from these exposures varies, depending on how often you do this type of work. To reduce your exposure to these chemicals: work in a well ventilated area and use a properly functioning dust extraction system. When the inhalation of dust cannot be substantially controlled, i.e., kept at or near the ambient (background) level, the operator and any bystanders should wear a respirator approved by NIOSH for the type of dust encountered.

Tool Description

Technical Specifications

Power Consumption	1600 Watts (13 amps @ 120 volts)
Motor Speed	1400 - 3400 RPM (no load)
Arbor Diameter	30 mm
Max. Blade Size	260 mm (10.25") dia., 2mm (⁵ / ₆₄ ") thick
Max. Depth (std.)	88 mm (3.46")

Max. Depth (tall)	120 mm (4.75") at 60 mm (2.3")
Max. Depth at 45° Bevel	55mm (2.2")
Max. Width at 90° Miter	305mm (12")
Max. Width at 45° Miter	210mm (8.25")
Weight	21.5 kg (47.3 lbs)

All metric dimensions are controlling. The arbor diameter is critical for safe operation, and is presented in metric only.

Supplemental User's Manual

Intended Use

The Kapex miter saw is intended to cut wood, plastic, aluminum, and similar materials. All applications beyond this are regarded as improper use. The tool should not be altered or used for any other purpose other than as specified in these operating instructions. Using the tool in

contravention to this manual may lead to injury and will void your warranty. The user shall be responsible and liable for accidents, injuries, and property damage resulting from misuse or abuse of this tool.

Functional Description



Item	Name or Description	Ref. Page(s)
A	Bevel Gauge and Pointer (both sides)	12, 18
B	Power Cord Storage	10
C	Tall Miter Latch	14, 22
D	Tall Miter Release	14, 22
E	Bevel Lock	12, 18
F	Bevel Range Selector	12, 18
G	Dust Extraction Port	10
H	FastFix® Arbor Lock	9
I	Trigger Lock	11

Item	Name or Description	Ref. Page(s)
J	Power Switch/Trigger	9, 10, 11
K	Main Handle	11, 17
L	Laser Dust Lens	28
M	Blade Guard	9
N	Miter Stop Release Lever	12, 15, 18, 20
O	Miter Lock Lever	12, 15, 18, 20
P	Miter Gauge and Pointer	12, 15,
Q	MiterFast™ Angle Tool and Storage	15

Functional Description (continued)



Item	Name or Description	Ref. Page(s)
A	Bevel Gauge and Pointer (both sides)	12, 18
I	Trigger Lock	9, 10, 11
J	Power Switch/Trigger	9, 10, 11
K	Main Handle	11, 17
L	Laser Dust Lens	28
M	Blade Guard	9
N	Miter Stop Release Lever	12, 15, 18, 20
O	Miter Lock Lever	12, 15, 18, 20
R	Bevel Adjustment Knob	12, 18

Item	Name or Description	Ref. Page(s)
S	Speed Control Dial (see inset)	11
T	Laser On/Off Button (see inset)	11
U	Depth Limit Adjustment Knob	13
V	Slide Lock Knob	10
W	Head Lock Knob	10
X	Auxiliary Fence	13
Y	Main Fence	13, 23
Z	Table Inserts	23

Setup

Setting Up a New Miter Saw

Congratulations on your purchase of a new Kapex Sliding Dual Compound Miter Saw. Before using your new miter saw, make sure you fully read and understand all of the instructions, precautions, and safety information presented in this manual.



WARNING! To avoid tipping the miter saw during use, the miter saw must be placed on a stable surface.



Note: There is a 2.5 mm hex key needed for making adjustments located in the Styrofoam packing material. Take care not to lose it.



Note: You may want to save the original box and packing material in case you ever need to send in the saw for service.

The KS120 miter saw is ready to use right out of the box, but there are several placement options available, depending on the intended use. These options include:

- ▶ For truly portable use, the KS120 may be used directly on a jobsite floor. The height of the cutting bed was specifically designed to coincide with the height of a Festool #1 Systainer, which can be used as an outfeed support.



- ▶ The KS120 can also be used on a level and stable jobsite work table. The saw must be securely clamped to the table to help prevent it from tipping or falling off.



- ▶ For a more permanent installation, the Kapex saw is equipped with 4 bolt holes, to be used with 1/4-20 (M6) bolts to securely bolt the saw to a work table.



- ▶ The Kapex saw was specifically designed to be compatible for operation on a Festool Multi-Function Table (MFT). The four feet under the saw coincide with the hole spacing of an MFT tabletop to keep the saw firmly in position, and the optional bolt kit permits quick mounting.



Note: When clamping or bolting the Kapex to a work table, take care not to over tighten the clamps or bolts, as this may distort the saw base.

Changing Sawblades



WARNING! To reduce the risk of injury from contact with a moving part, always unplug the saw before changing blades.

1. Push in and rotate the FastFix® arbor lock clockwise. This prevents the arbor from turning and also disables the motor.
2. Loosen the clamping screw on the arbor bolt guard, and rotate the guard away from the arbor bolt. (The combination hex key is stored on the back of the saw by the power cord.)



3. Unscrew the arbor bolt by turning it clockwise. The arbor bolt is a **left-hand thread** and turns the opposite of a standard screw.



4. Without pushing down on the trigger lock, pull up on the trigger to release the blade guard.
5. Raise the blade guard out of the way and remove the outboard arbor flange and sawblade from the arbor.
6. Inspect the friction lining on the two arbor flanges. If the lining is damaged, replace the flanges, as this can cause the sawblade to wobble.



Note: The friction lining on the arbor flanges grips the blade, but also permits the blade to slip slightly, in the event of a binding condition.

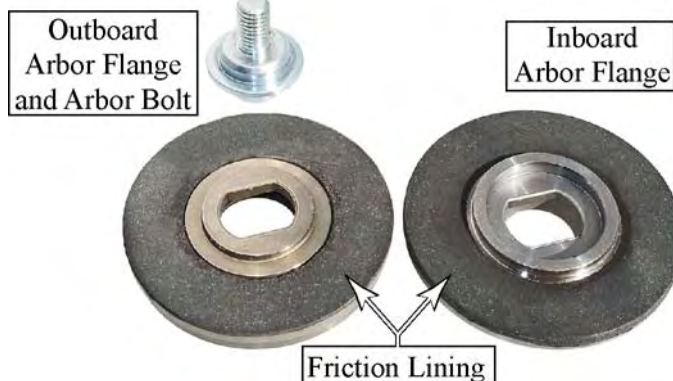

WARNING! When installing a new blade, make sure the arbor bolt is properly tightened and the rotation direction of the sawblade matches the rotation direction indicated on the saw (see image below).

7. Make sure the blade is oriented correctly and install the blade onto the inboard arbor flange.
8. Replace the outboard arbor flange, tighten the arbor bolt, and then unlock the FastFix arbor lock.



Transporting the Saw

When The Kapex miter saw is collapsed for transport, it is very well balanced and easily carried using the integrated carrying handles.

1. Unplug the saw and coil the power cord on the reel at the rear of the saw.



WARNING! To reduce the risk of unexpectedly starting the saw, make sure the saw is unplugged.

2. Pull the power trigger (without depressing the trigger lock) and lower the motor head down. When the head is in the down position, push in on the Head Lock Knob (see the picture to the upper right).
3. Push the motor head all the way to the rear of the saw and tighten the Slide Lock Knob.

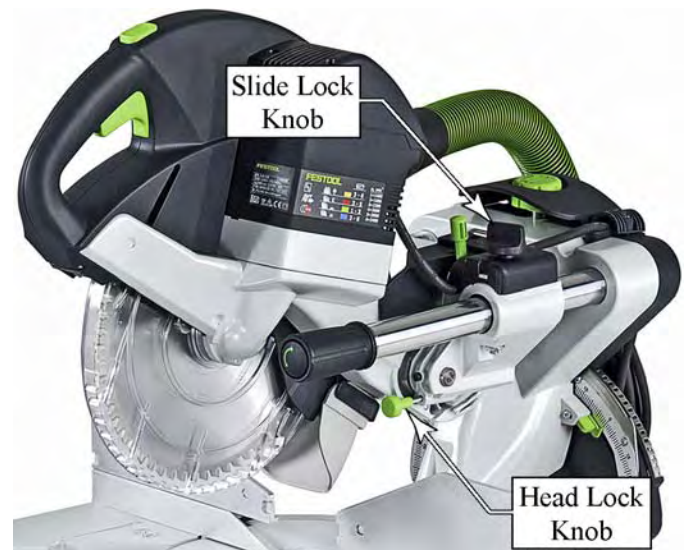

4. Set the miter angle to 60° and push down on the miter lock lever.
5. Pick up the saw from the rear by grasping the two handle points as shown below.



Dust Extraction

The Kapex saw can be connected to a dust extractor to substantially reduce dust during operation. The dust port swivels to either side, and accepts either a 27 or 36 mm Festool hose. The 27 mm hose fits inside the dust port, or the 36 mm hose fits over the outside of the dust port.



Note: For optimal dust extraction performance, Festool recommends using a 36 mm hose.

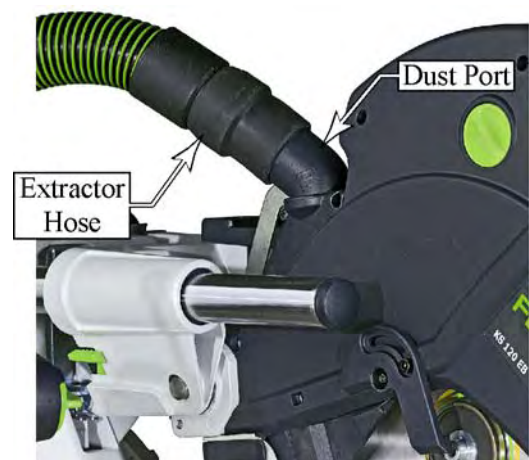

Basic Operation

Setting the Motor Speed

The Kapex saw has electronic speed control with soft-start circuitry. The electronic controller will maintain the motor speed even as the load changes. The speed control is infinitely variable from 1400 to 3400 RPM. The optimal speed of the saw is predominately determined by the type of material being cut.

Turn the speed control dial to the number shown in the table to the left. The speeds listed in the table are just rough guidelines, and actual results may vary.

Material	Speed
Soft wood products and veneer plywoods	6
Hardwood products	3-6
Plastic laminate countertops	6
Hard plastics	3-5
Soft plastics	1-4
Aluminum	4-6

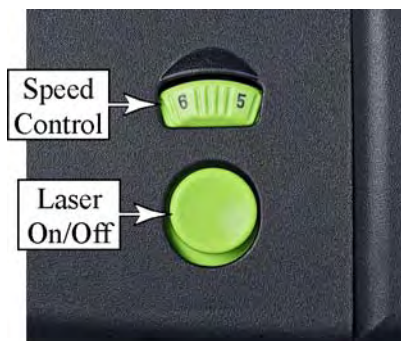

Using the Laser Guides



CAUTION! Laser Radiation. Do not look directly into the laser beam.

The Kapex saw contains a low-power solidstate laser system that scans across the path of the sawblade to indicate to the user where the blade will cut the workpiece. (The laser does not cut the workpiece.)

The two laser beams shine down on the workpiece on either side of the sawblade. The sawblade will cut the workpiece between the two laser lines.

To turn on the laser, press the On/Off button on the rear of the motor near the speed control dial. Pressing the button a second time will turn the laser off. The laser will also automatically shut off if left on for more than approximately 30 minutes.



Power Trigger and Plunge Release

The power trigger turns on the saw but also releases the motor head to plunge downward. To help prevent accidental starting of the saw, the trigger lock must be pushed to release the trigger to power the saw.

- ▶ To start the saw (activate the sawblade), press the trigger lock and squeeze the trigger. The saw head can then be plunged downward.
- ▶ To plunge the saw head down without starting the saw, squeeze the power trigger, but do not press the trigger lock.



Using the Hold Down Clamp

The hold down clamp fits in a socket on either the left or right sides of the saw. To insert or remove the clamp, rotate it to the rear to unlock it from the socket, as shown in the first image below. To lock the clamp in its socket, rotate it to the forward position, as shown in the center

image below. To secure the workpiece, press down on the green knob and rotate the locking handle down, as shown in the image on the right, below. To release the clamp, rotate the locking lever up.

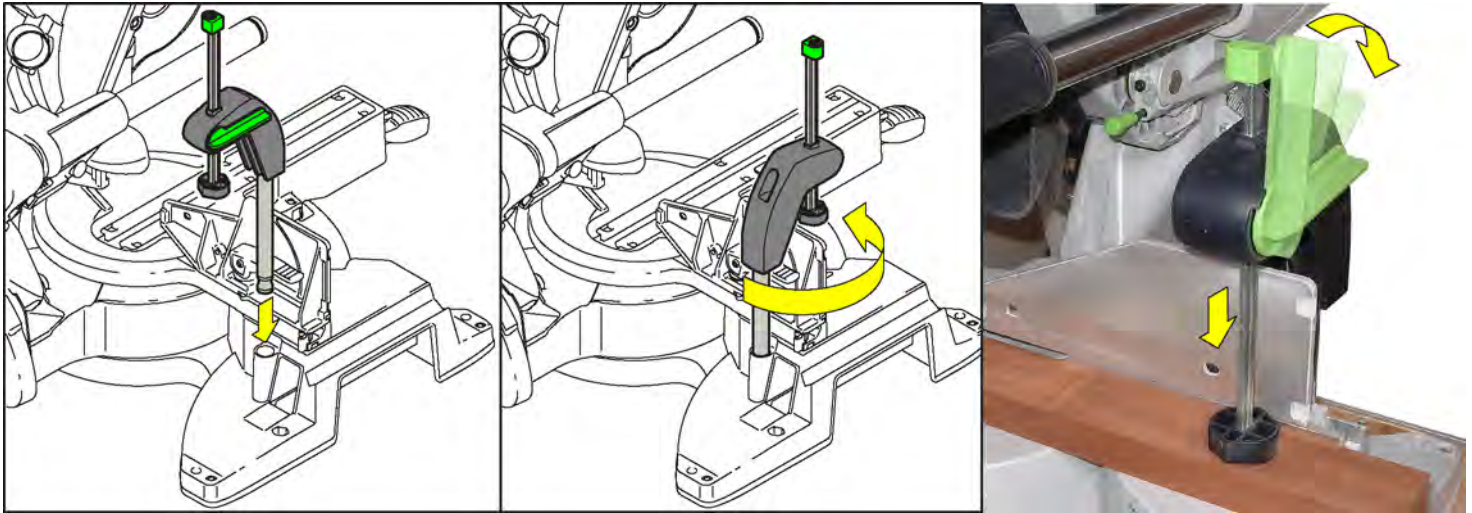

Setting the Miter Angle

A mitered cut is where the saw head is rotated side-to-side. The Kapex saw is capable of mitering 50° to the left and 60° to the right. Positive stops are located at 0, 22½, 30, and 45 degrees. The miter gauge pointer also includes ½ degree vernier indices for accurately setting the miter angle to half-degree values. Also refer to [“Using the MiterFast Tool”](#) described on page 15.

1. Release the miter lock by lifting up on the handle.

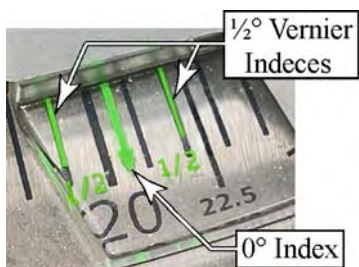

2. Press down on the miter stop release lever, and rotate the miter to the desired angle.



- ▶ To stop at one of the preset positive lock miter positions, release the miter stop lever just before reaching the angle, and the miter stop will click as it locks into position.
- ▶ To set the miter angle to ½ degree between the primary angles, line up the ½° vernier indices with the adjacent angle index marks. (The example shown to the left represents 20½°.)

3. When the desired miter angle is set, engage the miter lock by pressing down on the miter lock lever.



Note: When setting a miter angle very close to one of the miter stops (for example, at 45½°), keep holding down the miter stop release lever until you fully engage the miter lock lever, to prevent the miter angle from jumping to the nearby miter stop position.

Setting the Bevel Angle

A beveled cut is where the saw head is tilted to the left or right from vertical. The Kapex saw is capable of beveling up to 47° to the left and right.

The bevel range selector engages a series of angle stops. The selector has three settings. The first setting, (0-45°) limits the bevel travel between 0 degrees and 45 degrees to the left. The second setting ($\pm 45^\circ$) limits the bevel travel between 45 degrees to the left and 45 degrees to the right. The last setting ($\pm 47^\circ$) limits the bevel travel to the full extent of the saw, which is 47 degrees to the left and to the right.



NOTICE: These settings are not hard-limits, and turning the bevel adjustment knob into one of the limit settings will cause the spring loaded limit to be bypassed. However, it should be noted that doing so can cause premature wear to the bevel limits.

1. Release the bevel lock by lifting the lever.
2. As necessary, turn the bevel range selector to the desired range.



3. Rotate the bevel adjustment knob until the bevel index pointer is pointing to the desired angle. (There is a duplicate pointer on either side of the saw.)
4. Lower the bevel lock lever.

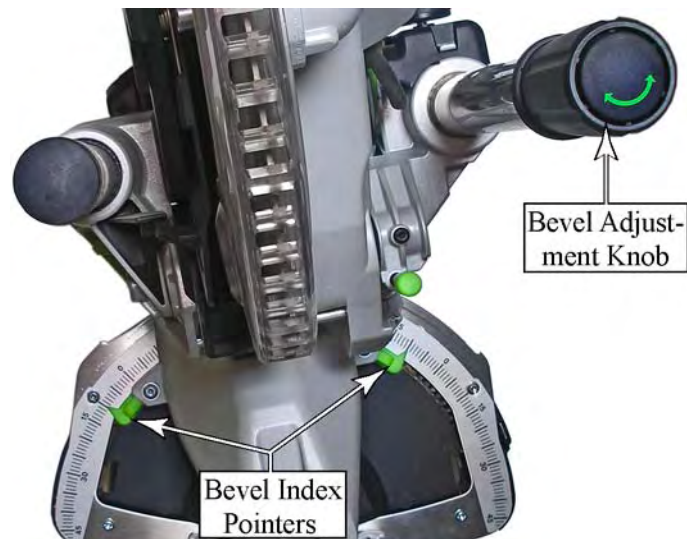

Using the Auxiliary Fence

The auxiliary fence provides support for taller workpieces. The two halves of the fence can be slid toward or away from the blade, or removed completely. Performing beveled cuts requires the auxiliary fence to be moved away from the blade area.

- ▶ **To move** the auxiliary fence, lift the locking lever, slide the fence, then lower the locking lever.
- ▶ **To remove** the auxiliary fence, lower the limit screw by turning it clockwise, then slide the fence out of the retaining slot.

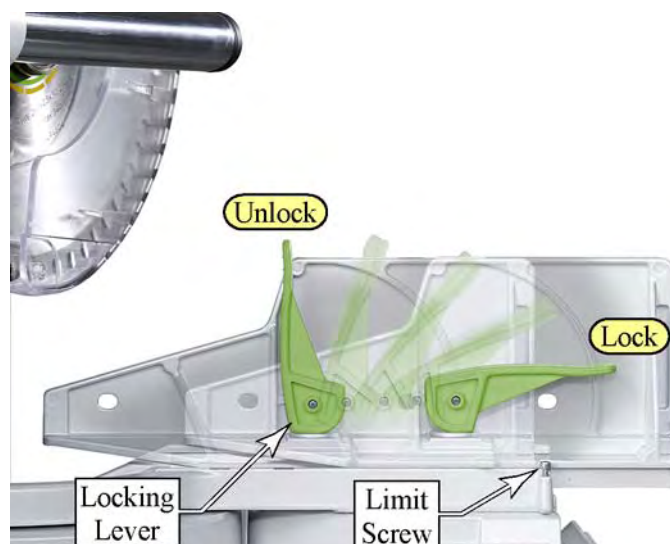

Setting the Depth Limit

The depth limit is used for making partial cuts that do not cut all the way through the workpiece, such as making dados. When the depth limit is engaged, the sawblade's vertical travel is limited from going below the preset height.

The height is easily adjustable by turning the depth limit knob. Turning the knob clockwise ¼-turn raises the sawblade by approximately 1 mm (0.040"), and turning it counterclockwise lowers the sawblade.

To engage the depth limit, pull the knob forward. To disengage the depth limit, push the knob back.

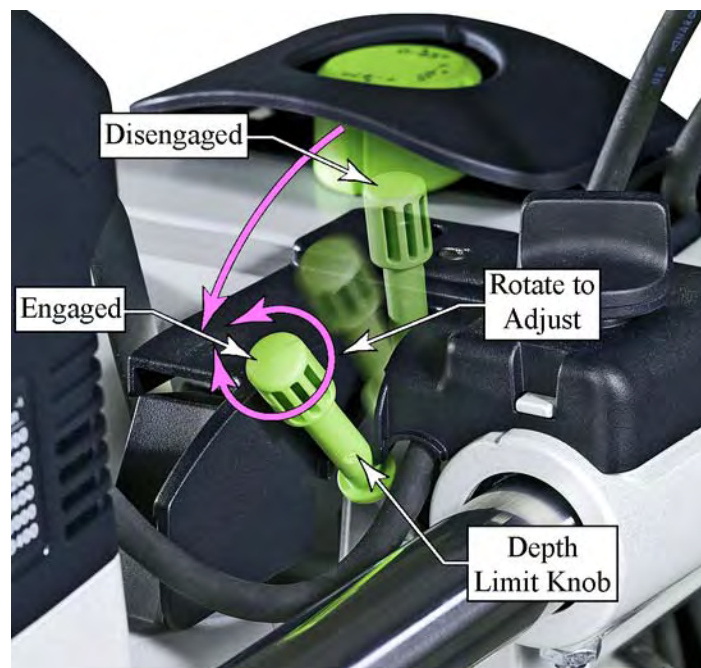

Using the Tall Miter Latch

The tall miter latch is used for cutting boards in the vertical position, such as mitering baseboard material. In this cutting position, the height of the cut is maximized. The miter latch holds the saw head slightly forward from its normal position, and also increases the maximum depth that the saw can plunge downward.



WARNING! To reduce the risk of injury from loss of control, never cut tall boards without the auxiliary fence installed. The workpiece can tip if not properly supported.



Note: The bevel position must be at zero degrees before you can engage the tall miter latch. The latch will not engage if the saw head is tilted.

Engaging the Tall Miter Latch

1. Pull the saw head away from the fence.
2. While holding the latch lever down, push the saw head back toward the fence until the tall miter latch locks into the back of the saw head.

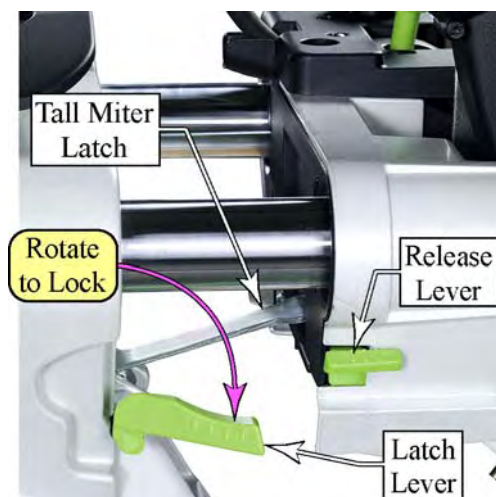

Releasing the Tall Miter Latch

While pressing down on the release lever (see previous image), pull the saw head away from the fence. The tall miter latch will spring to the vertical position when it releases.

Cutting the Workpiece

Stand the workpiece up against the fence and plunge the saw head down into the cut.



Using the MiterFast Tool

The MiterFast™ angle transfer tool converts a corner angle measurement into a miter setting. The miter line in the center of the tool is always at the midpoint of the two angle arms, and when lined up with the saw's laser, provides the proper miter angle for the measured corner.

Measure the Corner

- ▶ For measuring an outside corner, extend the extension arms as shown in the image below.
- ▶ For measuring an inside corner, retract the extension arms as shown in the second image below.

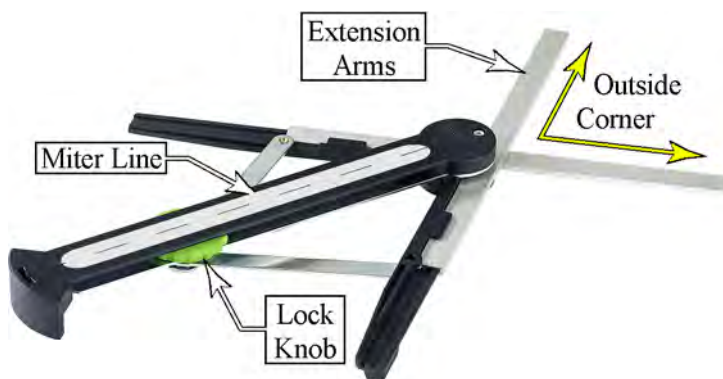

1. Loosen the lock knob on the MiterFast tool.
2. Place the MiterFast tool in (or on) the corner and slide the lock knob forward to expand the arms.
3. When the arms are lined up with the corner walls, retighten the lock knob.



4. Place the MiterFast tool on the saw with one of the arms up against the fence.
5. Turn on the laser for the saw. (Refer to [Using the Laser Guides](#) on page 11.)
6. Adjust the miter angle of the saw (refer to [Setting the Miter Angle](#) on page 12) until either of the laser beams line up with the miter line on the MiterFast tool.
7. Lock the miter setting on the saw.



8. Fold up the MiterFast tool and return it to its storage position in the base of the saw.

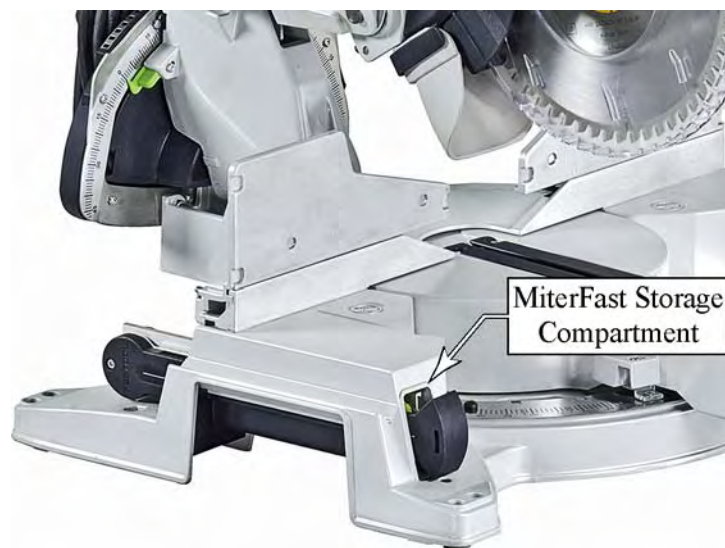

Using the Bed Extensions and Crown Stops

The optional bed extensions provide a useful platform for using additional workpiece control accessories as well as extending the size of the bed of the Kapex saw. The optional bed extension accessory includes the crown stop, as shown to the upper right.

The extension can be mounted to the left side or right side of the saw's bed, or if two are used, to both sides simultaneously.

The T-channel can also be used to secure additional clamping elements such as the Festool Quick Clamp or Screw Clamp shown to the right. These clamps can be used for clamping larger workpieces, or used in conjunction with the Kapex hold down clamp for multiple clamping needs, such as the dado example shown on page 19.



Installation

To install the bed extension, place the edge into the V-channel of the Kapex bed, position the extension forward or back as needed, and then tighten the clamping knob (see image to the right).

Setting up the Crown Stop

The crown stop is used for cutting crown moulding and holds the moulding at the desired angle against the fence of the saw so that it can be cut using a standard miter cut (refer to the [Crown Moulding](#) discussion on page 22). The stop slides forward or back depending on the size of the moulding, and clamps in place to serve as a secondary fence.

To set up the crown stop, place the moulding against the fence and bed of the saw, as shown in the lower left image, slide the crown stop up against the moulding, and tighten the clamping knob. Use the hold down clamp to secure the moulding while cutting, as shown in the lower right image.

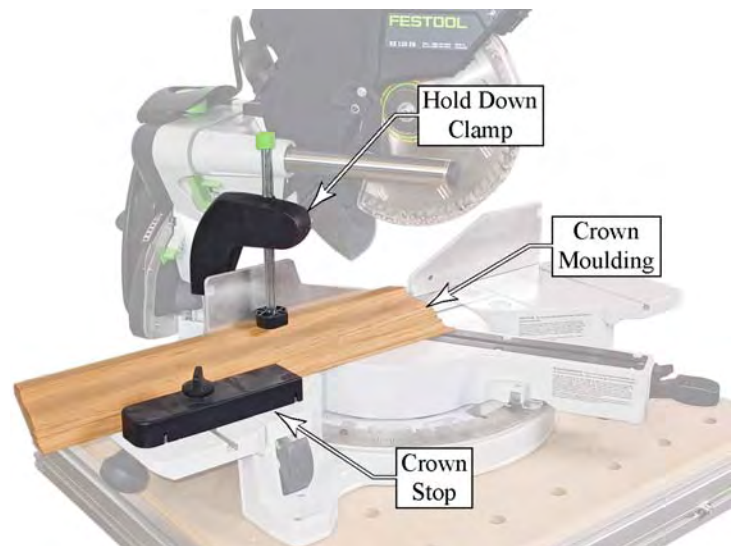
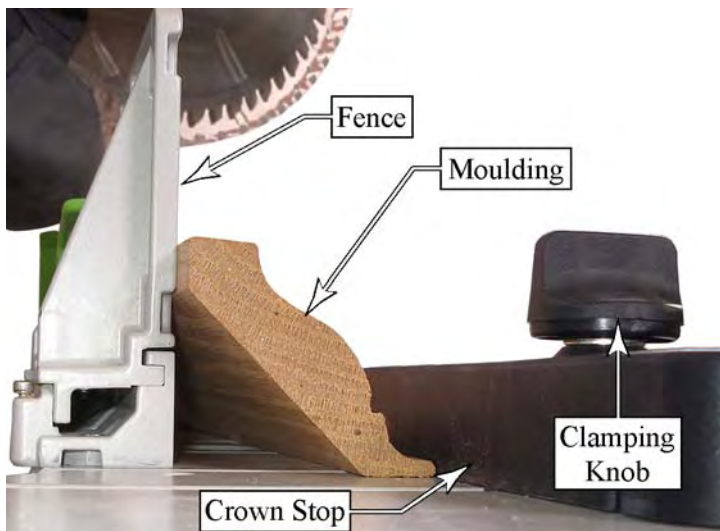
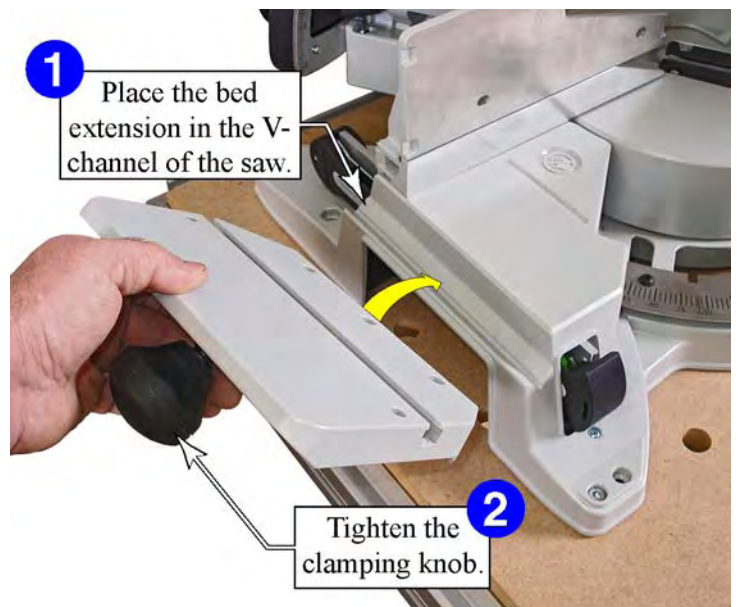

Cutting Techniques

There are three basic cutting techniques for sliding miter saws, but only two are proper and authorized. These are Chop-Cut, Push-Cut, and the improper method is a Pull-Cut.

Chop-Cut

A chop-cut is used for cutting narrow or tall stock, where the front edge of the workpiece is behind the center of the sawblade. For this type of cut, the saw head is brought straight down into the cut.

Push-Cut

A push-cut is used for cutting wider boards, but is also usable in most situations where a chop-cut could be used. For this type of cut, the saw head is pulled out toward the operator, plunged downward, and the primary cutting of the workpiece occurs as the saw head is being pushed back toward the rear of the saw (as shown in the picture below).

Pull-Cut (Improper Method)



WARNING! To reduce the risk of injury from loss of control, never use the pull-cut technique.

The third type of cut, called a pull-cut, or climb-cut, should be avoided for both safety reasons and for cutting performance reasons. This type of cut is made by plunging the saw head down, and then pulling it forward. The danger of this type of cut is that the sawblade wants to self-feed into the cut (called climb-cutting), and this can cause the saw head to jump forward unexpectedly. The reason this type of cut results in a poor quality cut is because it is using two different actions for the same cut. It starts out with a plunge-cut, and then finishes with a climb-cut. This means

that the sawblade is cutting the wood in two different manners, and there will frequently be a rough edge at the transition from one type of cut to the other.

Tips for Successful Cutting

- ▶ For more accurate cuts, mark your cutting length with a thin pencil line. A thick line will result in a less accurate cut length.
- ▶ When fitting one piece to another, it may be helpful to make the initial cut slightly long, and then trimming the cut to final length after test-fitting the piece.
- ▶ When cutting a new board, cut off the original factory end to ensure a square, fresh end, before measuring for your final length.
- ▶ When cutting small trim, use a zero clearance fence and/or insert to prevent small offcuts from being thrown behind the fence by the windage from the spinning blade (see page 23).
- ▶ When cutting multiple pieces of varying lengths from a limited supply of stock, always cut the longest pieces first, and cut the remaining pieces from the leftovers.
- ▶ Do not force the blade through the cut. A cleaner edge will be achieved with a steady, moderate feed rate.
- ▶ A chop-type of cut yields the lowest tearout on the front and top edges of the cut, but the most tearout on the rear side of the cut.
- ▶ A push-type cut yields moderate tearout on the top surface, but the best cut edge.

Diagram of Push-Cut Method



Miter Cuts

Miter cuts are used when a board needs to be cut at an angle across its width. The most common application for a miter cut is for joining two boards to form a corner without endgrain showing. The miter angle is one-half of the corner angle. So for a 90° corner, for example, the miter angle is 45°.

Miter Angles for Polygons		
Number of sides	Corner Angle	Miter Angle
3 – Triangle	120	60
4 – Square	90	45
5 – Pentagon	72	36
6 – Hexagon	60	30
7 – Heptagon	51.4	25.7
8 – Octagon	45	22.5

For even the most experienced woodworkers, cutting accurate and tight fitting miters can be problematic. The following are some tips for making accurate miters.

- ▶ Clamp the workpiece down. Because the sawblade is cutting at an angle with the workpiece edge and fence, it will tend to move the workpiece sideways, in the direction of the cut, as the cut progresses. This can result in a cut that is not straight, or the angle of the cut may be off.
- ▶ Cut slowly. Cutting too rapidly can cause the sawblade to deflect as it encounters varying densities in the woodgrain.
- ▶ Use a chop-cut only for narrow miters. When in doubt, use a push-cut.

- ▶ When marking the length of the workpiece, use a sharp pencil to draw a thin line. The thicker the line, the more difficult it will be to cut accurately on the line.
- ▶ When marking a workpiece length to match a wall or other structure, use a utility knife to mark the cut with a small nick. This is more accurate than a pencil line.



- ▶ If a utility knife is used to mark the cut, you can use a method called "Sneaking up on the cut." This is where you make an initial cut longer than needed, and continually make very small re-cuts until the cut line splits through the center of the nick you made with the utility knife.

Bevel Cuts

Bevel cuts are used when a board needs to be cut at an angle across its thickness. The most common application for a bevel cut is for constructing a box or similar structure.

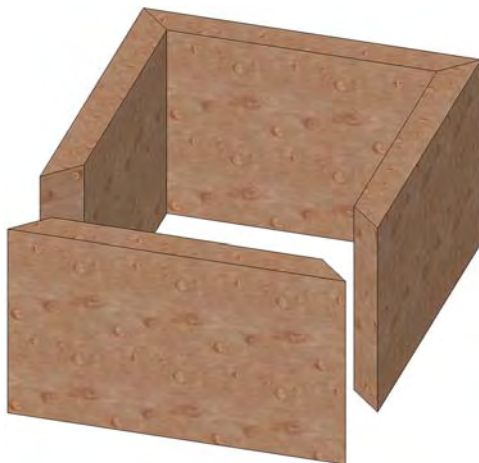

The following are tips for making accurate bevel cuts:

- ▶ Clamp the workpiece down. If the workpiece is not held firmly, the blade will tend to pull the workpiece into the cut and up the blade.
- ▶ For best results, use only a push-cut.
- ▶ Take care not to deflect the saw head sideways. Because the saw head is tilted to the side, it can be

easy to inadvertently push the saw head down or pull it up as you feed the saw into the cut. This will result in a crooked cut.

- ▶ Place the workpiece on the saw with the best-side down. Because of the angle of the blade teeth exiting the workpiece on the top side of the cut, there will be slightly more tearout on the top, especially on the sharper edge.

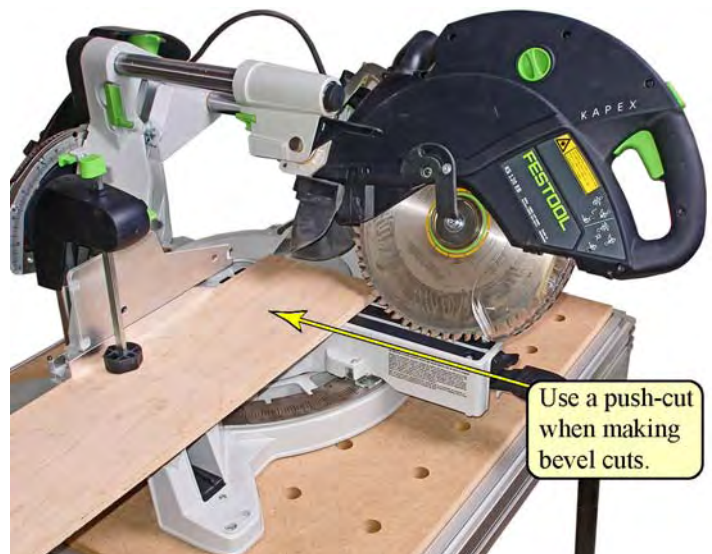

Depth Limited (Dado/Half-Lap) Cuts



WARNING! Never attempt to install or use a dado blade in the Kapex saw. Using either a stacked-dado or wobble-dado blade will exceed the capacity of the arbor, and the blade may impact the saw's guards, resulting in personal injury and damage to the saw.

A dado is a special type of cut where the depth of the cut does not go all the way through the workpiece. One common example of this type of cut is for making half-lapped joints, which is shown to the right and described below. In a half-lap joint, material is removed from the intersection of both workpieces comprising the joint. When the joint is assembled, the pieces overlap, creating a strong joint, but unlike a full-lap joint, the thickness of the joint is equal to just the thickness of the workpieces.

Depth Setting

For making a half-lap joint, it is necessary to set the saw's cutting depth to be exactly in the center of the workpiece thickness. The most accurate way of finding the center of a board is to trim from both sides until the two cuts meet.

Use a piece of scrap wood that is the same thickness as the actual workpiece. Starting with a depth setting that you know to be less than half the workpiece thickness, make a cut from the top side, and then flip the piece over and make a second cut, as shown below by the Red color. Gradually lower the depth of cut and repeat these two cuts until the two cuts meet, and the spine reaches a zero-thickness. This is exactly the center of the workpiece.

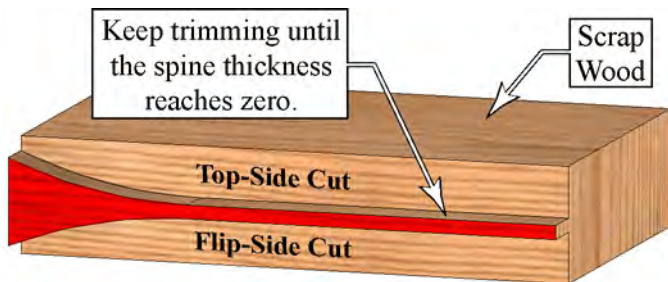

Fence Spacer

The center of the sawblade is 50 mm (2") forward of the saw's fence, which results in the curved ramp at the rear of the cut shown in the image below. To account for this and remove the radius at the end of the cut, add a 50mm (2") spacer in front of the fence, and clamp it in place with the Kapex hold down clamp as shown to the right.

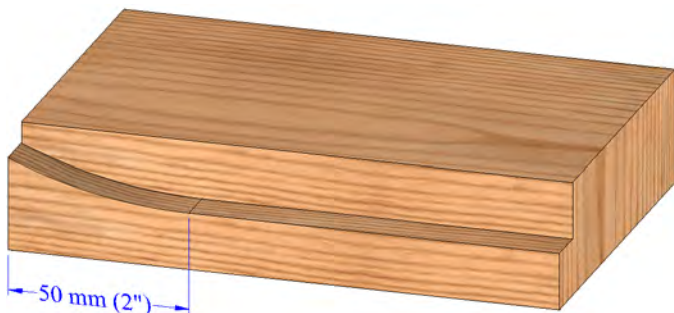

Half-Lap Joint

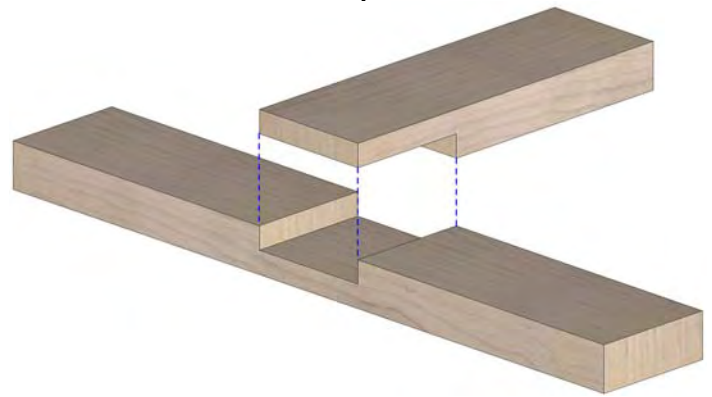

Clamping

It is important that both the fence spacer and workpiece are securely clamped to the saw for cutting. Use the Kapex Hold Down Clamp (see page 12) to clamp the fence spacer, and use an auxiliary clamp, such as a Festool Quick Clamp or Screw clamp (see page 16) to secure the workpiece.

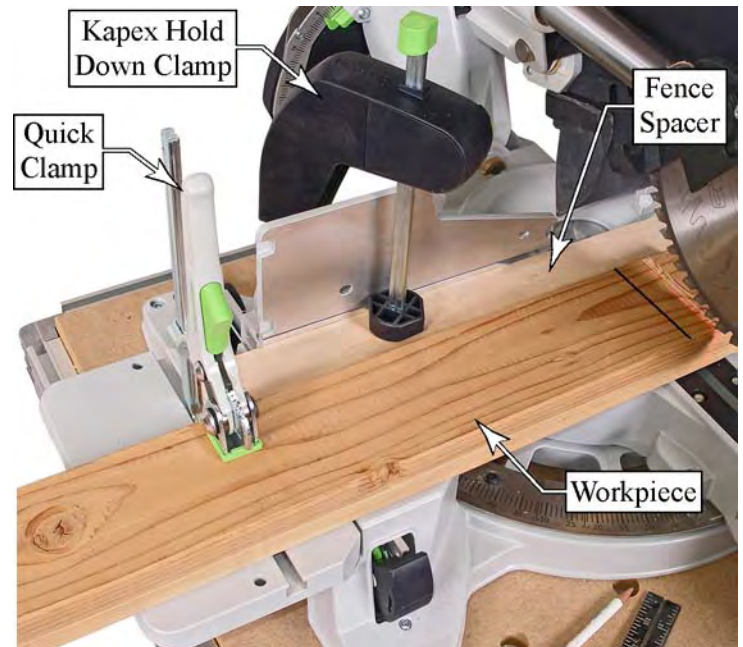

Cutting the Dado

Before cutting the dado, mark the right and left sides of the cut to indicate how wide the dado needs to be. Then make successive kerf-cuts between the lines until all the material between the lines is removed. The closer together each of these successive cuts are, the smoother the bottom of the dado will be. For best results, clean the bottom of the dado with a sharp chisel.

Compound Miter Cuts

Compound miter cuts are where the saw is both in a miter position and a bevel position at the same time. There are several applications for compound miter cuts, but cutting crown moulding and sloped miters are common examples. The example below shows a very simple birdfeeder roof.

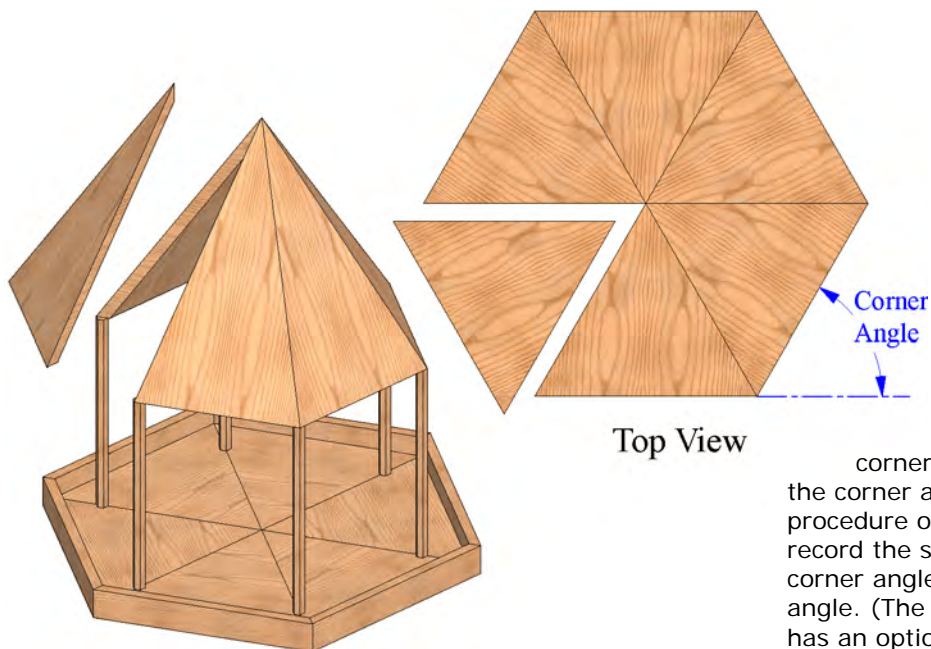

The greatest challenge with compound miters is determining the proper saw settings to achieve the desired miter angle. These saw settings can be found in look-up tables for standard mouldings, but for non-standard angles, determining the proper saw settings requires mathematical calculation.

i Note that there are several methods for accurately cutting crown moulding depending on the circumstances. Make sure to review the methods described in the applicable section on page 21.

Calculating compound miter settings requires two parameters from the desired joint: the **corner angle** and the **slope**.

Corner Angle

The corner angle is the angle between the two pieces, when viewed looking straight down on the joint. The corner angle is relatively easy to determine, but it is also the value that can cause the greatest amount of confusion for many woodworkers. That's because most woodworkers view angles differently than a mathematician will. A woodworker typically considers both inside and outside corners as 90 degrees (with a 45 degree miter) even though a mathematician would make the distinction that one corner is 90 degrees and the other is 270 degrees. To be consistent with miter saw settings, the corner angle is measured from a straight line between the two pieces, as shown above.

Slope

The Slope angle is the angle that each piece makes with respect to the base of the corner, such as the ceiling or floor in the examples provided here. For a roof-like structure, this would be the pitch of the roof. For crown moulding, this would be the compliment of the "Spring Angle" of the moulding. Common spring angles for mouldings are 38/52 and 45/45.

Determining the Corner Angle of Polygons

The corner angle for standard polygons is shown in the table on page 18.

Using the MiterFast Tool to Find a Corner Angle

For non-standard corner angles, such as a room that is slightly out of square, the MiterFast tool can be used to determine the corner angle. To use the MiterFast tool to measure the corner angle, follow the "[Using the MiterFast Tool](#)" procedure on page 15, but instead of making the cut, record the saw's miter setting angle. This angle is $\frac{1}{2}$ the corner angle, so multiplying by 2 will give you the corner angle. (The compound angle calculator on page 21 also has an option for letting you enter this angle directly without needing to double it.)

Determining the Slope of a Pyramid (Polyhedron)

A polyhedron is a pyramid that can have any number of sides. The easiest method for determining the slope of the polyhedron is by measuring the **Drop** and **Projection** of one face. These are the distances from the center-to-the-edge, and the base-to-the-point of the pyramid. Note that with a polyhedron with an odd number of sides, the center is found by drawing bisecting lines as shown in the image below.

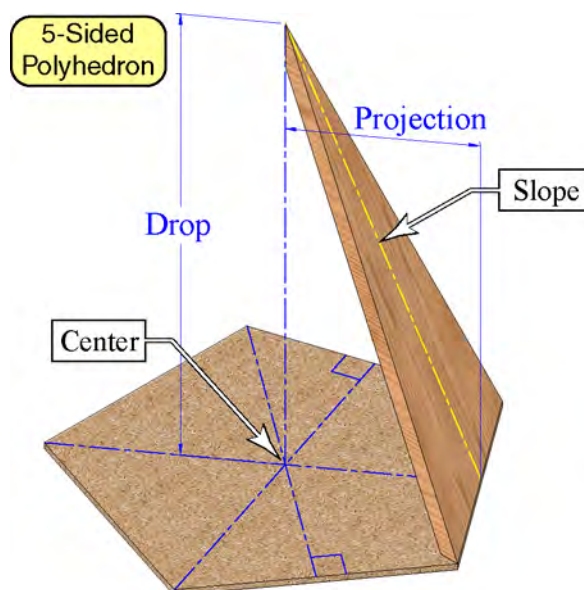

Determining the Slope of Crown Moulding

As was mentioned previously, the slope of a crown moulding is the compliment of its "Spring Angle" (the spring angle is measured relative to the wall, and the slope is measured relative to the ceiling). The two common spring/slope angles of crown moulding are 38/52 and 45/45. The reason why these angles are represented by dual numbers is because the actual angle depends on which direction the moulding is oriented. For example, turned one way, the slope is 38 degrees, but turned the other way, the slope is 52 degrees. Note that the sum of these two angles is always 90 degrees.

For mouldings that are not the standard 38/52 or 45/45, you will need to measure the moulding to determine its slope. This is very similar to measuring the **Drop** and **Projection** of a pyramid, but more care needs to be taken to ensure the measurements are taken from the correct locations. **Important:** The slope of a moulding does not

necessarily coincide with the "points" or "Tails" of the moulding. The slope is measured from the **back-side** of the moulding, regardless how long the tails of the moulding may extend (see image below).

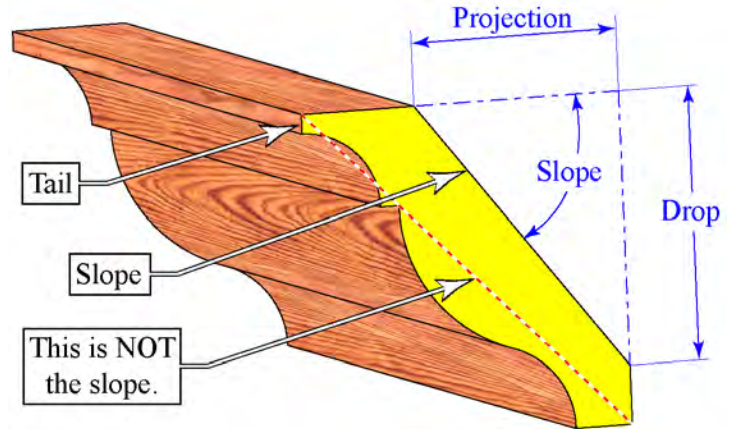

Calculating Compound Angles

There are two separate equations for calculating a compound angle. One equation is for calculating the miter setting of the saw, and the other equation is for calculating the bevel setting of the saw.

$$\text{Miter} = \text{ArcTan} \left[\text{Tan} \left(\frac{\text{CornerAngle}}{2} \right) \times \text{Cos}(\text{Slope}) \right]$$

$$\text{Bevel} = \text{ArcSin} \left[\text{Sin} \left(\frac{\text{CornerAngle}}{2} \right) \times \text{Sin}(\text{Slope}) \right]$$

If you don't know the **slope** angle, but you know the **Drop** and **Projection**, then use the following to calculate the slope:

$$\text{Slope} = \text{ArcTan} \left[\frac{\text{Drop}}{\text{Projection}} \right]$$



The most common error in calculating compound angles is using the wrong **Corner Angle**. As a double-check to your calculations, for nearly all cases, the Corner Angle should be less than 100°. The only time the angle should be significantly larger than 90° is either for a 3-sided box, or a wall corner with a sharp edge.

Compound Angle Calculator

A compound angle calculator has been built into this Adobe® Acrobat® PDF file. If you do not have an original electronic version of this manual, visit the <http://www.festoolusa.com/> website to download a copy.

Slope Angle Options

Slope Angle		Drop	
		Projection	

Corner Angle Options

Corner Angle		MiterFast Tool Angle	
--------------	--	----------------------	--

Results

Miter Setting	
Bevel Setting	

Note: If you are unsure about the corner angle you have entered, check the calculated "MiterFast Tool Angle" value. This number should be no more than 60 degrees for sharp corners, but otherwise, it should always be less than 45 degrees for most corners.

If it is significantly greater than 45 degrees, then you probably have the wrong "Corner Angle."

Crown Moulding

There are several methods for cutting crown moulding, and each method has its benefits depending on the specific application. The most common method for cutting crown moulding is to use a standard miter cut, where the moulding is tilted against the fence of the saw. For unusual situations, or when the moulding is too large to fit against the fence, compound miters are used. In some applications, inside corners are made using a method called "coping." Each of these methods will be described briefly.

Standard Miter

A standard miter cut is the easiest and most common method for cutting crown moulding. The Kapex miter saw has an optional auxiliary crown moulding fence (also called the Crown Stop) specifically for making this type of cut. The fence holds the moulding at the correct angle so it can be cut with a normal miter cut.

For this type of cut, you place the moulding on the saw as it would normally rest in the installed position. The edge that normally faces the ceiling is the edge that should be on the base of the saw.



Compound Miter

A compound miter cut is used when the moulding is too tall to use the standard miter method. This can also be used for a higher level of accuracy when the tails of the moulding are not perfectly perpendicular with each other (a common problem with most mouldings). Place the moulding on the saw with the flat back face on the base.

Coped Cut

A coped cut is sometimes used for making inside corners so there is no visible gap between the two pieces of moulding. A coped cut requires the use of a coping saw (a thin bladed handsaw for cutting

curves), but the initial cut is made with a miter saw. The first piece of moulding does not get a miter, and butts into the adjacent wall. The second piece of moulding gets a coped cut to match the profile of the first piece.

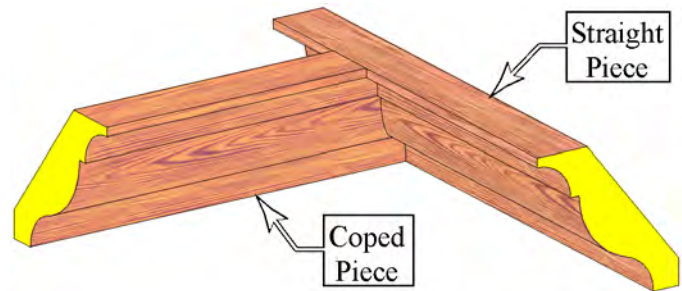

To make a coped cut, cut the second piece of moulding with a miter, just as though it was going to be a mitered joint. Then use a coping saw to cut along the edge of the resulting miter.

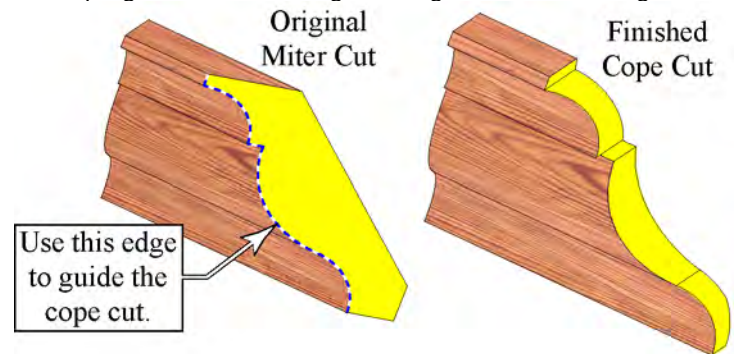

General Notes

- ▶ If you are mitering both ends of a piece of moulding, make the more difficult cut first, because it does not need to be at the exact length. For example, a right-handed operator may want to cut the left-hand miter first. This makes it easier cutting the second miter to exact length.
- ▶ When installing crown moulding around a room with walls that may not be square, use a piece of off-cut scrap moulding to test-fit the miters and lengths.
- ▶ It is mathematically impossible to make a mitered joint that changes two directions at the same time, such as putting crown moulding around a vaulted ceiling. You must either make a double miter joint, or use a corner block.

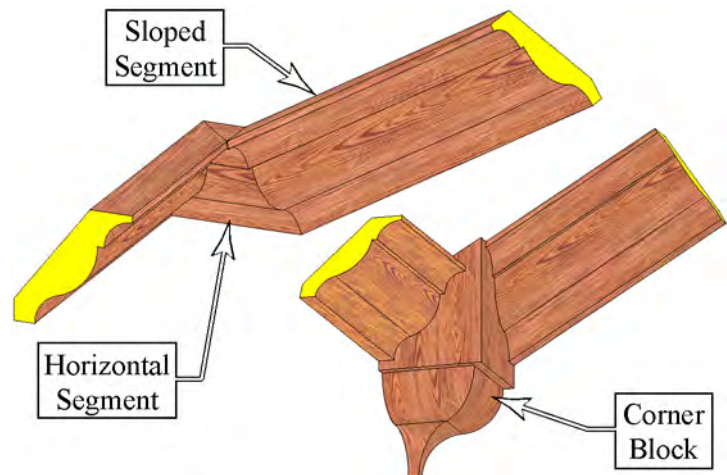

Adding Auxiliary Fence Faces

Auxiliary fence faces can be added to the Kapex fence. One of the primary benefits of adding fence faces is to create a zero-clearance fence opening for cutting smaller workpieces. The term, "zero-clearance" means that there is no gap between the sawblade and the fence. This is achieved by cutting the auxiliary fence to final length after it is installed.

Making the Auxiliary Fences

The auxiliary fences can be made from solid wood, composite wood (such as particle board), or soft (non-brittle) plastic.

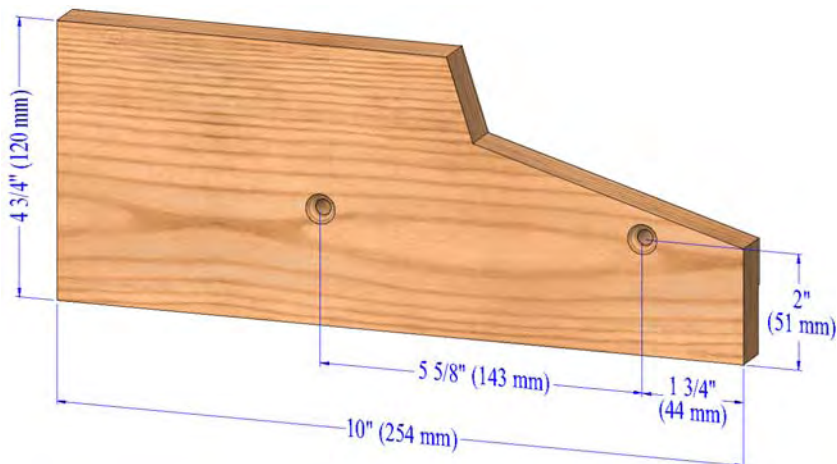

1. Cut your fence blanks to basic size. They can be wider or narrower; taller or shorter than the actual fence. Size them to best suit your needs.
2. Drill and countersink two 11/64" holes for #10 mounting screws.
3. If desired, trace the shape of the factory fence onto the auxiliary fence, and then cut the auxiliary fence with a band saw or coping saw.
4. To permit the fence to slide left or right, it is necessary to have a space between the auxiliary fence and the fixed portion of the factory fence. Use one of the options listed.

- ▶ **Option 1:** Place a washer on the back of each mounting screw.
- ▶ **Option 2:** Using a tablesaw or chisel, back-cut the lower rear of the fence to clear the fixed portion of the factory fence.

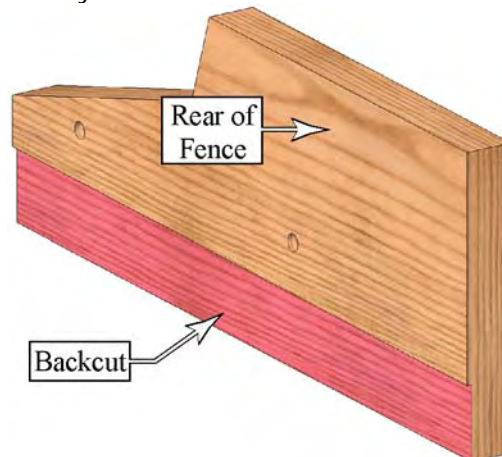

5. After mounting the auxiliary fence faces to the saw, use the saw to trim the ends for a zero-clearance fit. Trim one side at a time.



Making a Zero-Clearance Insert

A zero-clearance insert is helpful when cutting small pieces to prevent the offcuts from falling under the standard pair of inserts. The insert can be made from any hard wood. For best results, the insert should be custom fit to your saw, so use the dimensions shown below as a starting guideline. Adjust the thickness to be flush with the saw's

table. To make the countersunk holes for the mounting screws, first use a small forstner bit to drill the countersunk holes, and then a regular drill bit to drill a through-hole for the screw's shank. After the insert is installed and screwed down to the saw's table, cut the kerf opening with the saw using a standard push-cut.

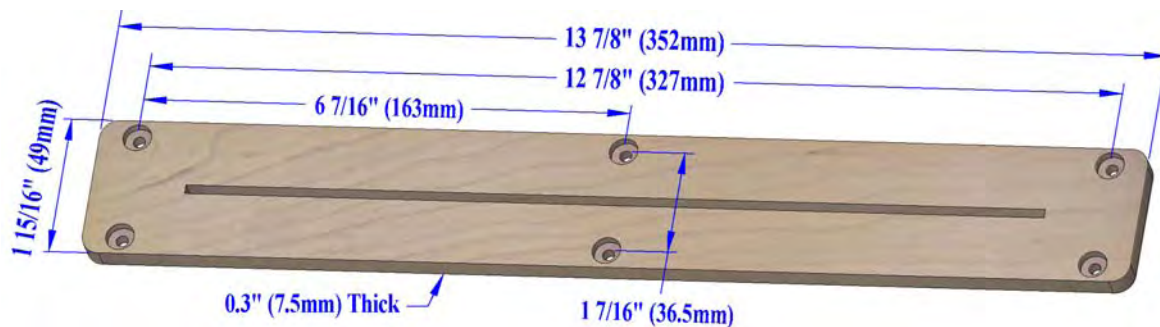

Calibration and Adjustment

The Festool Kapex miter saw comes fully calibrated from the factory and should not require further calibration out of the box or after normal use. The following calibration techniques should only be necessary in the event that your

saw is knocked out of alignment, such as can happen during frequent, or unsecured transport. Use these procedures only when your saw needs service.

Calibrating the Miter Angle

The calibration method described here is based on compounding an error by a factor of four. This makes it easier to detect extremely small calibration errors. However, care should be taken in over-using this calibration procedure because it has such a fine accuracy that it could be easy to get carried away and try to over-calibrate the saw. The factory calibration threshold is $\pm 0.16^\circ$, but this calibration procedure is capable of measuring errors as low as $\pm 0.001^\circ$, which is nearly impossible to obtain in actual practice.

The basis for this procedure is to make four successive cuts, where each new cut references from the previous cut. As a result, any angular error in the miter angle will propagate and be compounded with each cut. The final cutting error will have 4-times the actual error of the saw. In the diagram to the right, you can see that each successive offcut has a slightly larger angle than the previous offcut.

You may have heard of this method referred to as the "5-cut Calibration Method", but as long as you start out with a straight edge on the board, only 4-cuts are required. Furthermore, any additional cuts made after the fourth cut will not increase the accuracy, and it will remain at 4-times the original error.

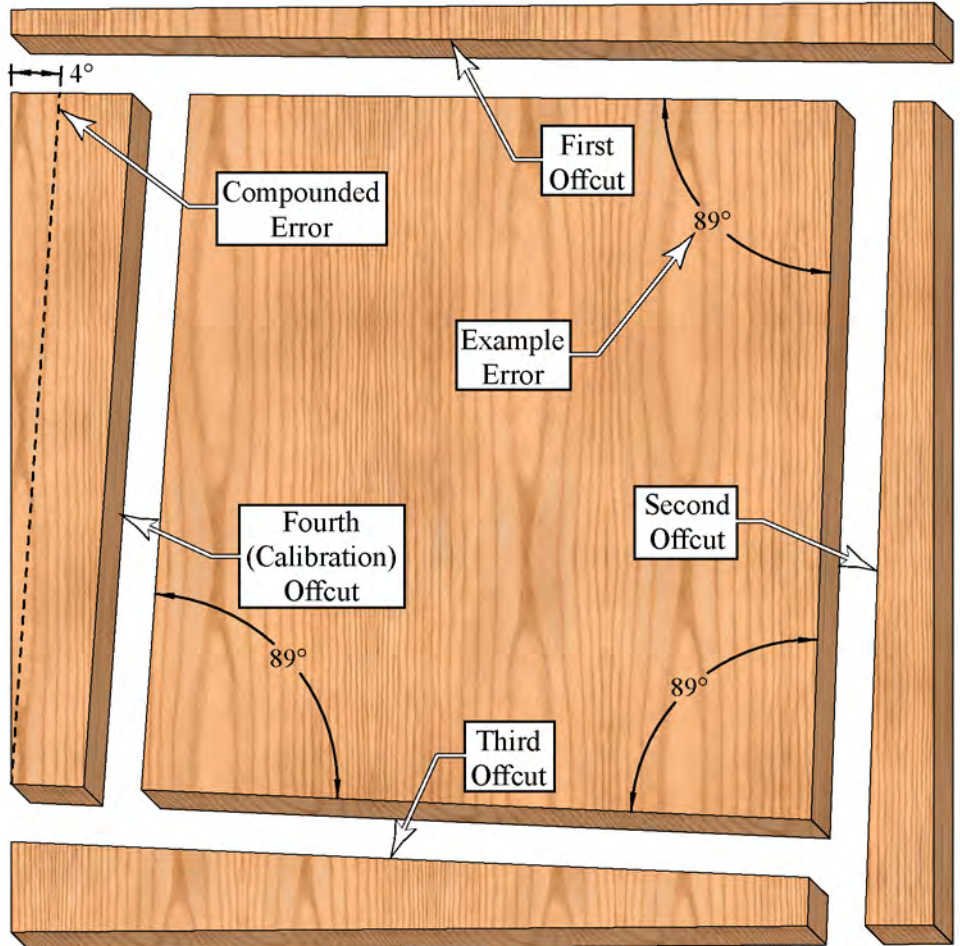

Getting Started

You will need a piece of scrap wood that is between 6 and 12 inches on a side. The scrap does not need to be perfectly square, but at least the first edge must be straight. The larger the piece, the more accurate your final measurement will be.

The material can be anything, but Medium Density Fiberboard (MDF) will give you the cleanest cuts, and therefore, the easiest to measure.

You will need a ruler to measure the length of the final offcut, and optionally, a dial caliper to accurately measure the difference in the width of the offcut at both ends. This width measurement is the most critical, so a dial caliper is recommended.



It does not matter whether your measurements are in metric units or imperial units.

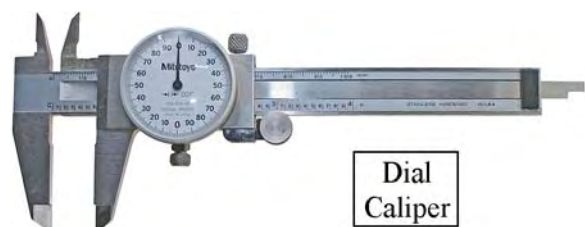

- ▶ High density plywood, such as Baltic birch, will also give very accurate results.
- ▶ Low-grade plywood may have rough edges, depending on the quality, and therefore, may provide the lowest accuracy.
- ▶ Solid wood can also be used, but you may experience burning on the rip-cuts if you are using a fine-tooth blade.

Measuring the Error

Before adjusting the saw, you first need to measure whether it is accurately calibrated to begin with. If you attempt to exceed the factory calibration threshold, you may end up actually making the saw less accurate.

- Number the sides of the scrap piece of wood from 1 to 4, starting with the best edge.
 - If you cut the wood on the left side of the blade (as shown in this example), then number the sides in a clockwise direction (as shown below).
 - If you cut the wood on the right side of the blade, then number the sides in a counterclockwise direction.
- On the #1 side, which will eventually become the final calibration offcut, label it "Left" and "Right" as shown. Do this regardless whether the cut is made on the left or right side of the sawblade.
- Place the scrap on the saw with the number "1" against the fence.

 **WARNING!** This procedure involves cutting small workpieces. To reduce the risk of injury, always clamp the workpiece to the saw.

- Cut approximately 1/4-inch off the board, so that there is at least a 1/8-inch offcut. This offcut ensures that the sawblade will be stable because there is wood on both sides of the blade during the entire cut.

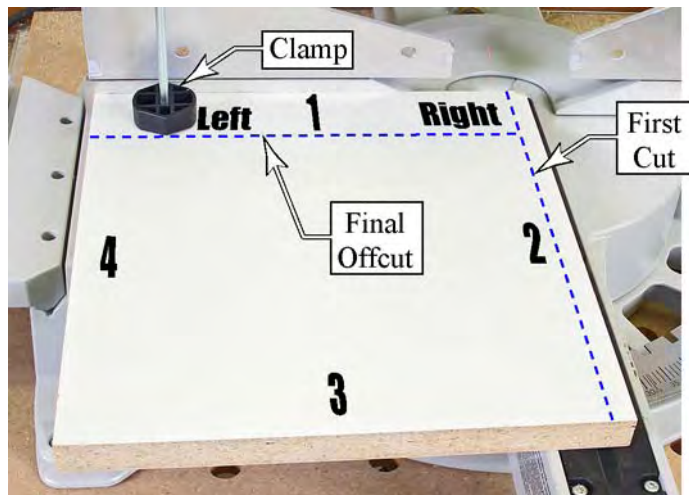

- Rotate the board with side #2 against the fence and repeat the same cut. Note that the side previously cut is now against the fence for each of the four cuts described below.
- Rotate the board to side #3 against the fence and repeat the same cut.
- Rotate the board to side #4 against the fence, but this time, make the cut a little wider, so that the offcut is large enough to handle without breaking it (approximately 1/4 to 1/2 inch wide).
- Discard the first three offcuts, but the fourth offcut is the calibration offcut.
- Measure the length of the fourth offcut. The accuracy of this measurement is not critical, so a standard tape measure or ruler will suffice.

Supplemental User's Manual

- Measure the width of the fourth offcut at both ends (as labeled "Right" and "Left"). These two measurements are critical, so use the best method you can.

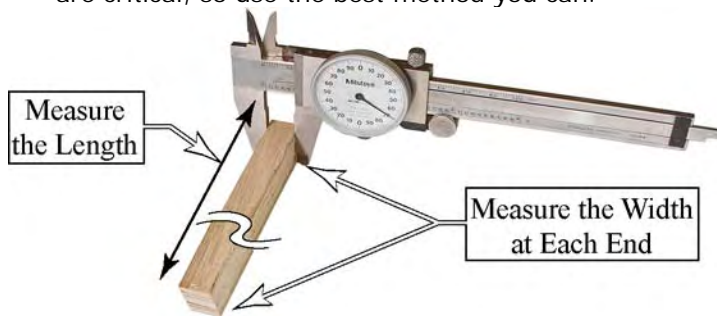

Calculating the Error

The equation for calculating the error is shown below, however, the electronic version of this manual also contains a built-in calculator. To use the calculator, enter your measurements (in either mm or inches) in the boxes and click on the "Calc Error" button. The calculated error (angle) is displayed to the right of the button.

$$Error = \frac{1}{4} \times Arc \sin \left[\frac{WidthLeft - WidthRight}{Length} \right]$$

Built-in Electronic Calculator			
Width Left		Width Right	
Length			

If the answer is a negative number (Right side wider than Left side), then your saw is cutting too much to the left of center. If the answer is a positive number, your saw is cutting too much to the right of center.

Adjusting the Saw

- With the miter handle out of the way, loosen only the middle screw on the miter gauge, and then move the miter handle back to zero.
- Engage the miter lock** by pressing down on the lock handle (see page 12). This locks the miter gauge to the miter handle, and prevents the gauge from moving until you are ready to move it.
- Loosen the remaining two screws on the miter gauge, and gently tap sideways on the miter handle to move the gauge as needed.
- Retighten all three screws.
- Repeat the calibration procedure to verify the results.

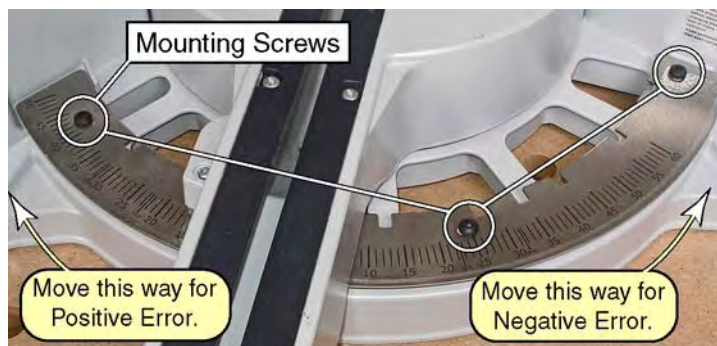

Calibrating the Bevel Angle

Calibrating the bevel angle uses the same 4-cut method described in the [Calibrating the Miter Angle](#) procedure on page 24. Refer to the discussion on page 24 for an explanation of the method.

Except for cutting tall miters, the bevel setting accuracy is generally less critical than the miter setting accuracy. Take care not to attempt to over-calibrate this setting.

Getting Started

You will need a piece of scrap wood that is between 4 and 4-3/4 inches on a side. The scrap does not need to be perfectly square, but at least the first edge must be straight. The larger the piece, the more accurate your final measurement will be, but 4-3/4" is the maximum size that can be cut using the Tall Miter Setting (see page 14).

The material can be anything, but Medium Density Fiberboard (MDF) will give you the cleanest cuts, and therefore, the easiest to measure.

- ▶ High density plywood, such as Baltic birch, will also give very accurate results.
- ▶ Low-grade plywood may have rough edges, depending on the quality, and therefore, may provide the lowest accuracy.
- ▶ Solid wood can also be used, but you may experience burning on the rip-cuts if you are using a fine-tooth blade.

You will need a ruler to measure the length of the final offcut, and optionally, a dial caliper to accurately measure the difference in the width of the offcut at both ends. This width measurement is the most critical, so a dial caliper is recommended.

 It does not matter whether your measurements are in metric units or imperial units.



Measuring the Error

Before adjusting the saw, you first need to measure whether it is accurately calibrated to begin with. The factory calibration threshold is $\pm 0.5^\circ$. If you attempt to exceed this calibration threshold, you may end up actually making the saw less accurate.

1. Number the sides of the scrap piece of wood from 1 to 4, starting with the best edge.
 - ▶ If you cut the wood on the left side of the blade (as shown in this example), then number the sides in a counterclockwise direction (as shown).
 - ▶ If you cut the wood on the right side of the blade, then number the sides in a clockwise direction.
 - ▶ Note that this is the opposite from the miter calibration numbering.

2. On the #1 side, which will eventually become the final calibration offcut, label it "Left" and "Right" as shown. Do this regardless whether the cut is made on the left or right side of the sawblade.
3. Lock the saw in the Tall Miter position. Refer to page 14.
4. Make sure that both auxiliary fences are in place and supporting the workpiece. Refer to page 13.
5. Place the scrap on the saw with the number "1" facing down against the base of the saw.



WARNING! This procedure involves cutting small workpieces. To reduce the risk of injury, always clamp the workpiece to the saw.

6. Cut approximately 1/4-inch off the board, so that there is at least a 1/8-inch offcut. This offcut ensures that the sawblade will be stable because there is wood on both sides of the blade during the entire cut.

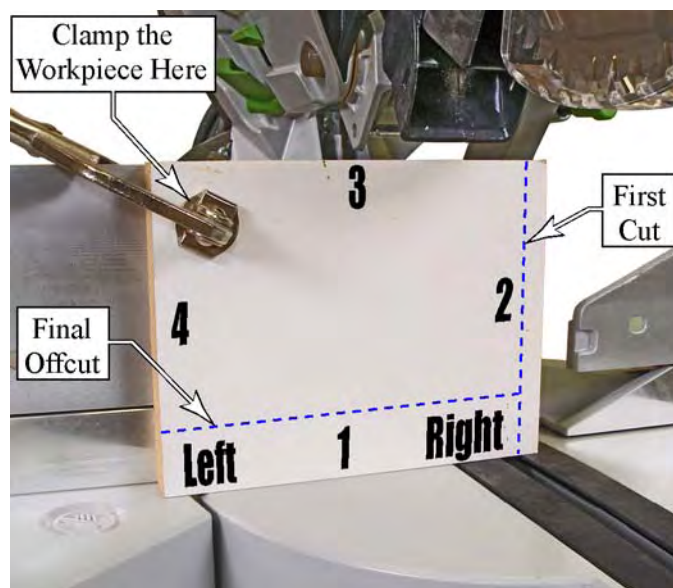

7. Rotate the board with side #2 against the base and repeat the same cut. Note that the side previously cut is now against the base for each of the four cuts described below.
8. Rotate the board to side #3 against the base and repeat the same cut.
9. Rotate the board to side #4 against the base, but this time, make the cut a little wider, so that the offcut is large enough to handle without breaking it (approximately 1/4 to 1/2 inch wide).
10. Discard the first three offcuts, but the fourth offcut is the calibration offcut.

11. Measure the length of the fourth offcut. The accuracy of this measurement is not critical, so a standard tape measure or ruler will suffice.
12. Measure the width of the fourth offcut at both ends (as labeled "Right" and "Left"). These two measurements are critical, so use the best method you can.

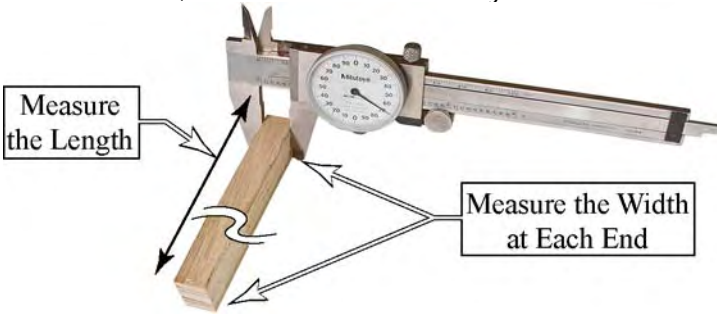

Calculating the Error

The equation for calculating the error is shown below, however, the electronic version of this manual also contains a built-in calculator. To use the calculator, enter your measurements (in either mm or inches) in the boxes and click on the "Calc Error" button. The calculated error (angle) is displayed to the right of the button.

$$Error = \frac{1}{4} \times \text{Arc sin} \left[\frac{\text{WidthLeft} - \text{WidthRight}}{\text{Length}} \right]$$

Built-in Electronic Calculator			
Width Left		Width Right	
Length			

- ▶ If the answer is a negative number (Right side wider than Left side), then your saw is cutting too much to the left of center.
- ▶ If the answer is a positive number, your saw is cutting too much to the right of center.

Adjusting the Saw

1. Using the hex key stored on the cord reel, slightly loosen the two adjusting screws located behind the cord reel shown below.
2. You may find it easier to move the entire saw head instead of just the bevel plate. To move the entire saw head, leave the bevel lock lever (see page 13) in the locked position. To move just the bevel plate, move the bevel lock lever to the unlocked position.
3. Carefully adjust the bevel angle to account for the error calculated previously.
4. Retighten the two screws, and repeat the procedure to verify the results.
5. When the calibration is correct, torque the two screws to 18 ft. lbs. (25 Nm).

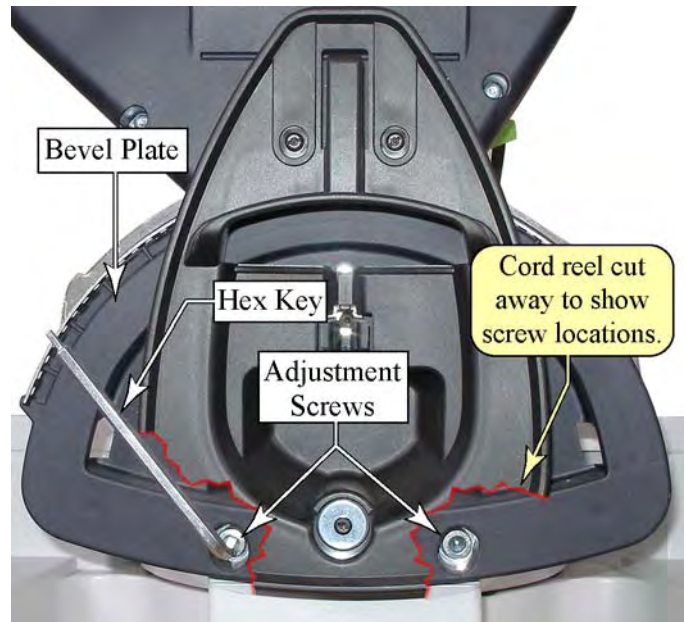

Calibrating the Lasers

In order to calibrate the lasers, you will need to puncture the decal on the side of the saw. The 2.5mm adjustment screw openings are identified by the small circles on the decal.

i The 2.5 mm hex key is shipped with the saw and is located in the Styrofoam packing material.

- ▶ The Tilt adjustment is used to ensure the lasers are pointing parallel to the sawblade, so they trace out the same line regardless whether the saw is raised or lowered.
- ▶ The Yaw adjustment rotates the laser (as viewed from above the saw) so it remains parallel with the path of the saw cut (front-to-rear).
- ▶ The lateral adjustment moves the laser toward or away from the saw cut (sawblade).

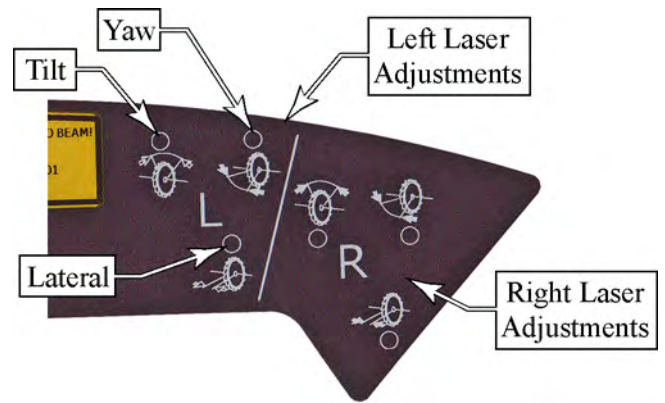

Setup

1. Before beginning, remove the laser dust lens and clean it. To remove the lens, loosen the retaining screw, push in and down on the ribbed surface to release the locking tabs, and then slide the lens out of the saw.

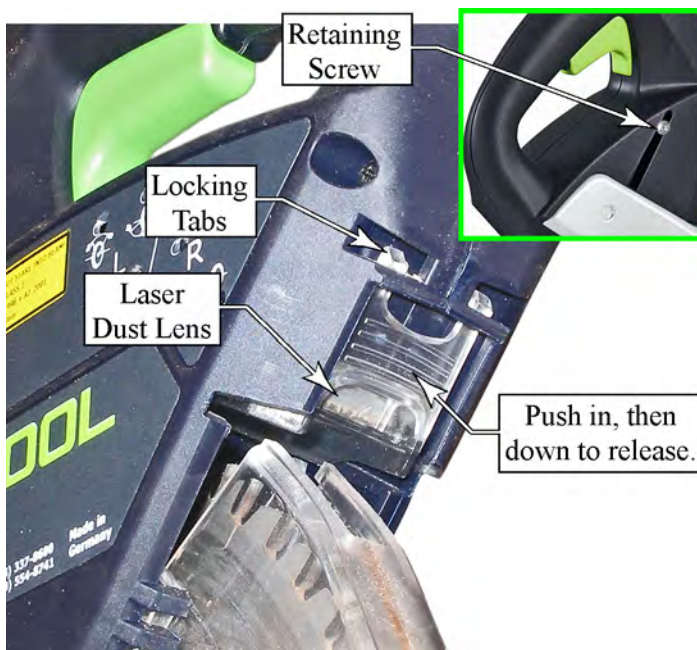

2. Wipe off any dust and debris from the lens with a soft cotton cloth, or rinse it with water and mild soap.
3. Reinstall the lens before making adjustments to the lasers.



4. Clamp a smooth piece of scrap wood to the saw and using the depth limit (see page 14), make a shallow kerf cut across the board.
 - ▶ This kerf cut will help you aim the lasers where the saw actually cuts.

- ▶ You can use any wood that has a relatively smooth surface. The white melamine board shown below provides a good contrast between the board surface and the kerf cut.

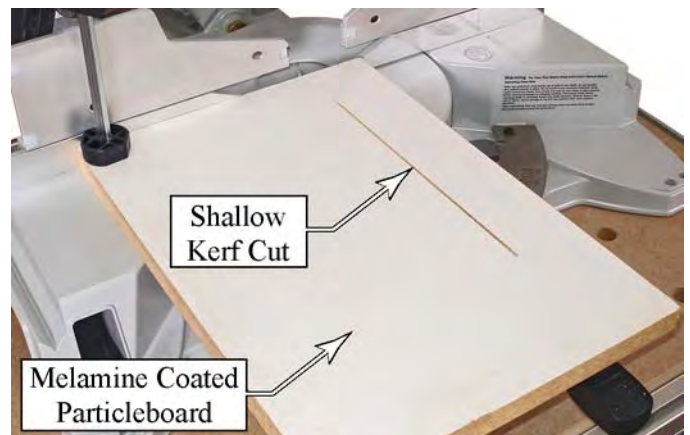

5. Turn on the laser.
6. Begin by adjusting the yaw settings so both lasers are parallel with the saw cut.

i Make sure to remove the hex key from the screw before gauging your progress. The pressure of the hex key is enough to deflect the laser.

7. Next, lower the sawblade down into the kerf (touching the wood) and temporarily adjust the lateral setting until the laser is against the edge of the kerf.
8. Raise the saw back to the top, and adjust the tilt setting so the laser remains against the edge of the kerf (at the same position as the previous setp).
9. Verify the tilt adjustment by raising and lowering the saw and check that the laser remains the same distance away from the kerf.
10. Finally, adjust the lateral position to line up with the edge of the saw cut.





i It is a matter of your own personal preference as to whether the laser lines split the edge of the kerf, or if they remain just outside of the kerf. Adjust the lateral position that you prefer.

Troubleshooting

Symptom	Possible Causes
Motor does not start	<ul style="list-style-type: none"> ▶ Check that the cord is properly plugged into an outlet. ▶ Make sure the outlet has power. Check the circuit breaker or try another outlet. ▶ If used with a Festool dust extractor, make sure the selector switch is pointing to "Auto". The auxiliary outlet on the dust extractor has power only when the selector is at Auto. ▶ Inspect the power cord (including extension cords) for damage or missing prongs. ▶ The motor brushes may have worn and need replacement.
Lasers do not work	<ul style="list-style-type: none"> ▶ The lasers turn off automatically if the saw is not used for a period of time. Press the Laser On/Off button to turn the lasers back on. ▶ Check that the cord is properly plugged into an outlet. ▶ Make sure the outlet has power. Check the circuit breaker or try another outlet. ▶ If used with a Festool dust extractor, make sure the selector switch is pointing to "Auto". The auxiliary outlet on the dust extractor has power only when the selector is at Auto. ▶ Inspect the power cord (including extension cords) for damage or missing prongs. ▶ Inspect the laser dust lens for excessive dust (see page 28).
Excessive tearout on the bottom edge of the cut	<ul style="list-style-type: none"> ▶ This can occur with plunging and/or pulling cuts (see page 17). ▶ Too fast of a feed rate through the cut. ▶ Too coarse of a blade for a crosscut operation.
Excessive tearout on the top side of the cut	<ul style="list-style-type: none"> ▶ This can occur with a push cut, especially with thicker materials. ▶ Too fast of a feed rate through the cut. ▶ Too coarse of a blade for a crosscut operation.
Excessive tearout at the rear of the cut	<ul style="list-style-type: none"> ▶ This is common for plunge cuts, and slightly less prominent with push cuts. ▶ Too fast of a feed rate through the cut. ▶ Use a backing board or auxiliary fence.
Saw cuts are burning	<ul style="list-style-type: none"> ▶ Make sure to use the correct blade for the material. ▶ Make sure the blade is sharp. ▶ Make sure the blade is installed correctly (not turning backward). ▶ Keep the workpiece clamped to prevent it from moving into the blade. This is especially true for miters and bevels where the blade tends to pull the workpiece into the blade. ▶ Reduce the motor speed.
Saw cuts are wavy	<ul style="list-style-type: none"> ▶ Do not make plunge-then-pull type cuts, as this can lead to uneven cuts. ▶ Make sure to keep the workpiece firmly clamped in position, especially for miter and bevel cuts. ▶ Don't change the feed rate during the cut. Keep a constant and steady feed rate. ▶ Bent or damaged sawblade, such as missing teeth.
The Tall Miter Latch won't engage	<ul style="list-style-type: none"> ▶ Make sure the bevel setting is at zero degrees. The tall miter latch will not engage if the saw head is tilted.

Optional Accessories

Sawblades

Combination Blade		
Tooth Type	ATB, 60 teeth	
Hook Angle	-5°	
Item Number	494 604	
Description	This is the standard blade that comes with the saw. With a moderate tooth count and ATB tooth grind, this blade provides good results when a single blade is needed for general purpose cutting. The blade incorporates asymmetrical tooth spacing to reduce harmonic vibration.	
Fine Crosscut Blade		
Tooth Type	ATB, 80 teeth	
Hook Angle	-5°	
Item Number	494 605	
Description	With a high tooth count and ATB tooth grind, this blade provides excellent, chip-free crosscutting of lumber and fine (cabinet-grade) plywood. The blade incorporates asymmetrical tooth spacing to reduce harmonic vibration.	
Fine Laminate Blade		
Tooth Type	Flat-tipped ATB, 64 teeth	
Hook Angle	-5°	
Item Number	494 606	
Description	The ultra-hard, flat-tipped (FT) ATB teeth on this blade reduces chipping of laminates and solid surface materials without dulling. The FT- ATB grind results in the performance of an ATB grind, with the longevity of a TCG grind.	
Aluminum and Plastic Blade		
Tooth Type	TCG, 68 teeth	
Hook Angle	-5°	
Item Number	494 607	
Description	The high tooth count, TCG grind of this blade provides long lasting sharpness and good control for cutting aluminum and hard plastic.	

Notes

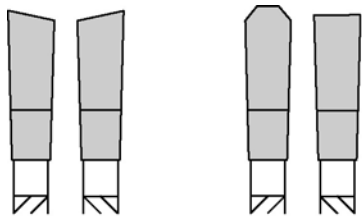

ATB

TCG

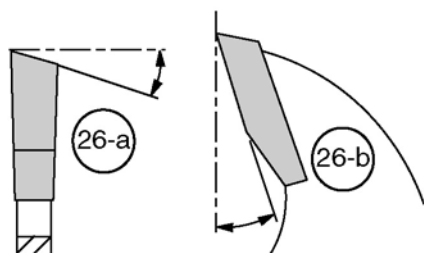

ATB: Alternate Top Bevel. The ATB type blade slices through wood fibers, first on one side and then on the other for clean cuts in natural and manmade materials.

TCG: Triple Chip Grind. The TCG type blade is designed to cut through hard materials. The trapezoidal tooth cuts the center of the kerf and the flat raker tooth cuts the edges. This type of blade design is more resistant to dulling.

26-a Bevel Angle: All of the ATB-type blades shown above have a bevel angle of 15°. This moderate bevel angle helps provide good chip-free cutting without rapidly dulling.

26-b Hook Angle: The higher the hook angle, the more the tooth grabs the material and pulls it into the cut. Ripping blades have a very high hook angle to cut aggressively. Lower hook angles are used for harder materials where greater control is needed.

Tooth Count: The more teeth a blade has, the smoother it will cut. Conversely, blades with fewer teeth cut more aggressively.

MFT/3-Kapex Table

495 565

The MFT/3-Kapex work support table is specifically designed for use with the Kapex saw. It is slightly shorter than a standard MFT/3 and also has additional mounting holes for placing the saw. The saw may be positioned close to the front edge, close to the rear edge, more to the left, or more to the right.

The height of the MFT/3-Kapex is lower so the Kapex is at a more comfortable working height. This height also coincides with the height of a standard MFT/3, which can be used as workpiece support tables.



Bolt Down (Clamping) Kit

494 693

The bolt down kit includes bolts and threaded knobs for quickly securing the Kapex saw to a Multi Function Table.



Crown Stop

494 369

The crown stop is used to support the forward edge of crown moulding when cutting the moulding tilted against the fence for making non-compound miter cuts.





Free Manuals Download Website

<http://myh66.com>

<http://usermanuals.us>

<http://www.somanuals.com>

<http://www.4manuals.cc>

<http://www.manual-lib.com>

<http://www.404manual.com>

<http://www.luxmanual.com>

<http://aubethermostatmanual.com>

Golf course search by state

<http://golfingnear.com>

Email search by domain

<http://emailbydomain.com>

Auto manuals search

<http://auto.somanuals.com>

TV manuals search

<http://tv.somanuals.com>