

120V PLUG-IN CARBON MONOXIDE ALARM WITH BATTERY BACK-UP AND TEST/SILENCE

Reliable Protection, Maximum Convenience!

- Just install the battery, plug the alarm into a regular outlet, test, and it's ready to go!
- Battery back-up keeps alarm working if electricity fails.
- Memory stores highest levels of CO detected. Easy to display, easy to clear!

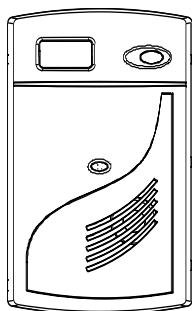

120V AC ~
60 Hz 0.09A

LISTED TO
UL 2034

Model CO614

Printed in Mexico
M08-0190-002 P 01/08

**IMPORTANT!
PLEASE READ CAREFULLY AND SAVE.**

This user's manual contains important information about your Carbon Monoxide (CO) Alarm's operation. If you are installing this CO alarm for use by others, you must leave this manual—or a copy of it—with the end user.

TABLE OF CONTENTS

Introduction1-2
 Basic Safety Information1
 How Your CO Alarm Works1
 Understanding Your CO Alarm2
 Using the Peak CO Memory2
Installation2-3
 Where to Install CO Alarms2
 Where CO Alarms Should NOT Be Installed3
 How to Install Your CO Alarm3
If Your CO Alarm Sounds3-4
 If the Alarm Signal Sounds3
 Using the Silence Features4
Testing and Maintenance4
 Weekly Testing4
 Regular Maintenance4
 Replacing the Battery4
What You Need To Know About CO4-5
 What is CO?4
 Symptoms of CO Poisoning4
 Finding the Source of CO After an Alarm5
 Potential Sources of CO in the Home5
 How Can I Protect My Family?5
Underwriters Laboratories Inc. UL20345
Frequently Asked Questions6
General Limitations Of CO Alarms6
Limited Warranty6

© 2008 BRK Brands, Inc., a Jarden Corporation company (NYSE: JAH)
 3901 Liberty Street Road, Aurora, IL 60504-8122
 All rights reserved.
 Consumer Affairs: (800) 323-9005 • www.firstalert.com

INTRODUCTION

BASIC SAFETY INFORMATION

IMPORTANT!

- Dangers, Warnings, and Cautions alert you to important operating instructions or to potentially hazardous situations. Pay special attention to these items.
- **THIS IS NOT A SMOKE ALARM!** This CO Alarm is designed to detect carbon monoxide from ANY source of combustion. It is NOT designed to detect smoke, fire, or any other gas.
- This CO Alarm is approved for use in single-family residences. It is NOT designed for marine or RV use.

CAUTION!

- This CO Alarm will only indicate the presence of carbon monoxide gas at the sensor. Carbon monoxide gas may be present in other areas.

WARNING!

- The Silence Feature is for your convenience only and will not correct a CO problem. Always check your home for a potential problem after any alarm. Failure to do so can result in injury or death.
- This CO Alarm should receive continuous 120VAC, 60 Hz, pure sine wave electrical power. (The battery is meant for emergency back-up only). Do not use in an extension cord or outlet controlled by a dimmer or switch. In order for the emergency battery back-up to work, a working (fresh) battery must be properly installed.
- NEVER ignore your Carbon Monoxide Alarm if it alarms. Refer to "If Your CO Alarm Sounds" for more information. Failure to do so can result in injury or death.
- Test the CO Alarm once a week. If the CO Alarm ever fails to test correctly, have it replaced immediately! If the CO Alarm is not working properly, it cannot alert you to a problem.
- This product is intended for use in ordinary indoor locations of family living units. It is not designed to measure CO levels in compliance with Occupational Safety and Health Administration (OSHA) commercial or industrial standards. Individuals with medical conditions that may make them more sensitive to carbon monoxide may consider using warning devices which provide audible and visual signals for carbon monoxide concentrations under 30 ppm. For additional information on carbon monoxide and your medical condition contact your physician.

HOW YOUR CO ALARM WORKS

GENERAL INFORMATION

CAUTION!

Leave your CO Alarm plugged in year-round. CO problems can occur any time during the year, and this Alarm can only alert you if it is plugged in and receiving power.

This CO Alarm is intended for use in a standard, unswitched 120V AC wall outlet. It is not intended for use in extension cords, power strips, or outlets controlled by a switch or dimmer. These may not provide continuous power to the unit. When fully powered, the unit samples the air and takes a new reading about every second. A microchip inside the unit stores each reading, and remembers the levels of CO it has been exposed to over time. The Alarm sounds when it has been exposed to a "critical" level of CO (measured in parts per million or "ppm") within a specified time (measured in minutes). This CO Alarm features a permanently installed sensor, an indicator light, and an 85 dB alarm horn. It also has a Silence Feature to temporarily quiet the alarm horn.

MALFUNCTION WARNING

This unit performs self-diagnostic tests approximately every second. If the Alarm malfunctions, replace it immediately.

THE COVER OF YOUR CO ALARM

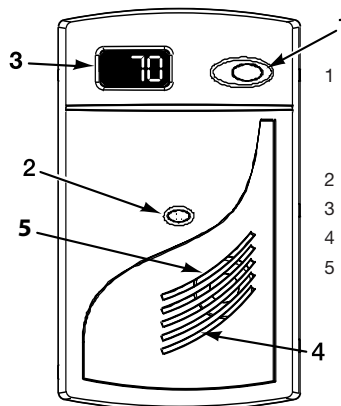

- 1 Test/Silence/Scroll Button: Press and release to select mode (Test, Memory, Clear Memory); Press and hold to activate mode, or to silence the alarm.
- 2 POWER/ALARM Light (Red)
- 3 Digital Display
- 4 Air Vents
- 5 Alarm Horn: 85 dB audible alarm for test, alarm, and unit malfunction warning

UNDERSTANDING YOUR CO ALARM

BASIC POWER CONDITIONS

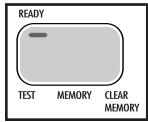

Alarm operating on AC power



Alarm operating on emergency battery back-up

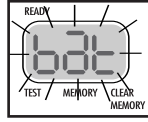

Low / missing battery warning

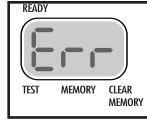

"Err" Alarm is not operating properly

What you see and hear during installation

WHEN YOU FIRST INSTALL THE BATTERY:

- HORN:** Chirps briefly
- DISPLAY:** Flashes "888" briefly; switches to "bat" after a minute
- POWER/ALARM Light:** Flashes once a minute

WHEN YOU FIRST PLUG-IN THE CO ALARM:

- HORN:** Silent
- DISPLAY:** Dash appears by "READY"
- POWER/ALARM LIGHT:** Shines continuously

UNDER NORMAL CONDITIONS (AC POWER):

- HORN:** Silent
- DISPLAY:** Dash remains lit at "READY"
- POWER/ALARM LIGHT:** Shines continuously

WHEN YOU TEST THE CO ALARM:

- HORN:** Sounds loudly - 4 beeps, pause, 4 beeps, pause
- DISPLAY:** Flashes "30, 70, 150, 400" briefly
- POWER/ALARM LIGHT:** Flashes rapidly

What you see and hear under different conditions:

DURING A POWER FAILURE (IN BATTERY BACK-UP):

- HORN:** Silent
- DISPLAY:** Displays the word "bat" continuously
- POWER/ALARM LIGHT:** Flashes once a minute.

WHEN THE ELECTRICITY COMES BACK ON:

- HORN:** Silent
- DISPLAY:** Dash appears by "READY"
- POWER/ALARM LIGHT:** Shines continuously.

IF BATTERY BECOMES LOW OR IS MISSING:

- HORN:** Chirps once a minute*
- DISPLAY:** The word "bat" flashes on and off
- POWER/ALARM LIGHT:** Flashes once a minute

IF THE CO ALARM IS NOT OPERATING PROPERLY:

- HORN:** Three rapid chirps every minute
- DISPLAY:** Displays "Err"
- POWER/ALARM LIGHT:** Flashes three times in sync with the horn.

What you see and hear if CO is detected:

PRE-ALARM LEVELS:

- HORN:** Silent
- DISPLAY:** Shows CO levels detected in ppm
- POWER/ALARM LIGHT:** On continuously

ALARM LEVELS OF CO ARE DETECTED:

- HORN:** Sounds loudly - 4 beeps, pause, 4 beeps, pause. This sequence repeats for as long as the unit is in alarm*
- DISPLAY:** Shows CO levels detected in ppm
- POWER/ALARM LIGHT:** Flashes rapidly

*Note: If unit goes into alarm under battery back-up power, the regular 4 beeps-brief pause cycle will repeat for four minutes. After four minutes, the pause will increase to 1 minute.

IF YOU SILENCE THE ALARM:

- HORN:** Silent for about 4 minutes*
- DISPLAY:** Shows CO levels detected in ppm
- POWER/ALARM LIGHT:** Flashes rapidly

*Note: After 4 minutes, if CO levels drop below alarm levels, the unit will remain silent and return to normal operation. If CO presence still indicates a potentially dangerous situation, the horn will sound again.

IF THE CO LEVELS RETURN TO NORMAL:

- HORN:** Silent
- DISPLAY:** Dash lit by "READY"
- POWER/ALARM LIGHT:** Shines continuously

USING THE PEAK CO MEMORY

The CO Memory Feature lets you check the highest level of CO recorded during an alarm.

To check CO Memory:

1. Press and release the Test/Silence/Scroll button until the dash scrolls to "MEMORY".
2. Press and hold Test/Silence/Scroll button to display Memory CO level.

To clear CO Memory:

1. Press and release the Test/Silence/Scroll button until the dash scrolls to "CLEAR MEMORY."
2. Press and hold the Test/Silence/Scroll button until the display shows "CLr."

NOTE: The highest CO level will be saved, even after a power interruption, until you clear it. DO NOT clear the CO Memory reading if you plan to call someone to investigate a CO problem! Clear the CO Memory reading only after the investigator has checked your home.

INSTALLATION

WHERE TO INSTALL CO ALARMS

The National Fire Protection Association (NFPA) recommends that a CO Alarm should be centrally located outside of each separate sleeping area in the immediate vicinity of the bedrooms. For added protection, install additional CO Alarms in each separate bedroom, and on every level of your home.

If your bedroom hallway is longer than 40 feet (12 meters), install a CO Alarm at BOTH ends of the hallway.

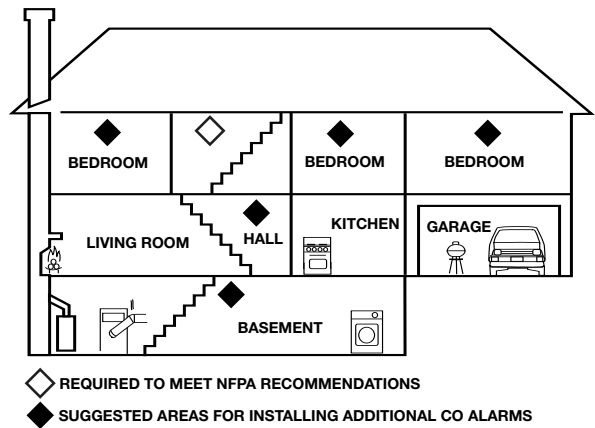

In a Single-level Home:

- Install at least one CO Alarm near or within each separate sleeping area.
- For added protection, install an additional CO Alarm at least 20 feet (6 meters) away from the furnace or fuel burning heat source.

In a Multi-level Home:

- Install at least one CO Alarm near or within each separate sleeping area.
- For added protection, install at least one CO Alarm on each level of the home. If you have a basement, install that CO Alarm at the top of the basement stairs.
- For added protection, install an additional CO Alarm at least 20 feet (6 meters) away from the furnace or fuel burning heat source.

⚠ WARNING!

This unit should receive continuous electrical power. (The battery is meant for emergency back-up only). Choose an outlet where it can't be accidentally unplugged or switched off by children. Keep small children away from the unit. Teach them not to play with it or unplug it. Explain what the alarms mean.

WHERE CO ALARMS SHOULD NOT BE INSTALLED

DO NOT locate this CO Alarm:

- In garages, kitchens, furnace rooms, or in any extremely dusty, dirty or greasy areas.
- Closer than 15 feet (4.6 meters) from a furnace or other fuel burning heat source, or fuel burning appliances like a water heater.
- Within 5 feet (1.5 meters) of any cooking appliance.
- In extremely humid areas. This Alarm should be at least 10 feet (3 meters) from a bath or shower, sauna, humidifier, vaporizer, dishwasher, laundry room, utility room or other source of high humidity.
- In areas where temperature is colder than 40° F (4° C) or hotter than 100° F (38° C). These areas include non-airconditioned crawl spaces, unfinished attics, uninsulated or poorly insulated ceilings, porches, and garages.
- In turbulent air, like near ceiling fans, heat vents, air conditioners, fresh air returns, or open windows. Blowing air may prevent CO from reaching the sensors.
- In direct sunlight.
- In outlets covered by curtains or other obstruction.

⚠WARNING!

- This CO Alarm is designed for use inside a single-family home or apartment. It is not meant to be used in common lobbies, hallways, or basements of multi-family buildings unless working CO Alarms are also installed in each family living unit. CO Alarms in common areas may not be heard from inside individual family living units.
- This CO Alarm alone is not a suitable substitute for complete detection systems in places which house many people, like hotels or dormitories, unless a CO Alarm is also placed in each unit.
- DO NOT use this CO Alarm in warehouses, industrial or commercial buildings, special-purpose non-residential buildings, RVs, boats, or airplanes. This CO Alarm is specifically designed for residential use, and may not provide adequate protection in non-residential applications.

HOW TO INSTALL YOUR CO ALARM

IMPORTANT! Read all instructions before using this product.

Quick reference:

- Install the 9V battery to activate the battery back-up.
- Plug the Alarm into a standard 120V unswitched outlet.
- Test the CO Alarm.

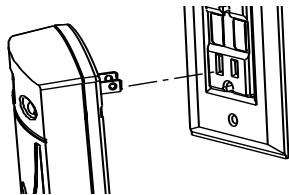

TO ACTIVATE OR CHANGE BATTERY BACK-UP

1. Open the battery compartment on the back of the Alarm.
2. Insert the new battery, making sure it snaps completely into the battery terminals and cannot be shaken loose.
3. Close the battery compartment, then test the battery back-up by pressing the Test/Silence/Scroll button.
4. Plug the CO Alarm into the outlet.

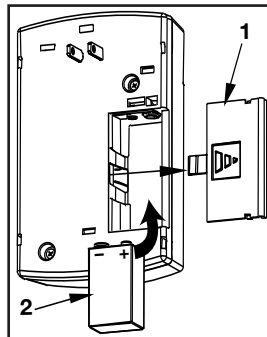

IMPORTANT!

The battery back-up is designed to provide emergency power to the CO Alarm for 7 days. Actual back-up time depends on the strength (freshness) of the battery. The battery back-up will not work unless a good battery is properly installed.

PLUG THE ALARM INTO AN OUTLET

⚠WARNING!

This CO Alarm should receive continuous electrical power. The battery is meant for emergency back-up only. Do not plug this Alarm into an outlet controlled by a dimmer or switch.

1. Plug the unit into a standard UNSWITCHED 120V AC outlet. The unit should be located where it can wake you if it alarms at night.
2. Make sure the POWER/ALARM light shines continuously when you plug it in.
3. Test by pressing the Test/Silence/Scroll button firmly until the unit sounds: 4 beeps, pause, 4 beeps. During testing, the POWER/ALARM light will flash and "30, 70, 150, 400" will scroll on the Display. This is normal.

PREPARE YOUR ALARM LABELS

Find the pair of self-adhesive labels included with this CO Alarm.

- On each label write in the phone number of your emergency responder (like 911) and a qualified appliance technician.
- Place one label near the CO Alarm, and the other label in the "fresh air" location you plan to go if the alarm sounds.

NOTE: A qualified appliance technician is defined as "a person, firm, corporation, or company that either in person or through a representative, is engaged in and responsible for the installation, testing, servicing, or replacement of heating, ventilation, air conditioning (HVAC) equipment, combustion appliances and equipment, and/or gas fireplaces or other decorative combustion equipment."

IF YOUR CO ALARM SOUNDS

⚠WARNING!

Actuation of your CO Alarm indicates the presence of carbon monoxide (CO) which can kill you. When your CO Alarm sounds, you must not ignore it!

IF THE ALARM SIGNAL SOUNDS:

1. Operate the Test/Silence button.
2. Call your emergency services, fire department or 911. Write down the number of your local emergency service here:

3. Immediately move to fresh air—outdoors or by an open door or window. Do a head count to check that all persons are accounted for. Do not re-enter the premises, or move away from the open door or window until the emergency services responder has arrived, the premises have been aired out, and your CO Alarm remains in its normal condition.
4. After following steps 1-3, if your CO Alarm reactivates within a 24-hour period, repeat steps 1-3 and call a qualified appliance technician to investigate for sources of CO from fuel-burning equipment and appliances, and inspect for proper operation of this equipment. If problems are identified during this inspection have the equipment serviced immediately. Note any combustion equipment not inspected by the technician, and consult the manufacturers' instructions, or contact the manufacturers directly, for more information about CO safety and this equipment. Make sure that motor vehicles are not, and have not, been operating in an attached garage or adjacent to the residence. Write down the number of a qualified appliance technician here:



"ALARM-MOVE TO FRESH AIR"

If you hear the alarm horn and the red light is flashing, move everyone to a source of fresh air. DO NOT unplug the CO Alarm!

⚠WARNING!

Alarms have various limitations. See "General Limitations of CO Alarms" for details.

Continued...

USING THE SILENCE FEATURES

The Silence Feature is intended to temporarily silence your CO Alarm's horn while you correct the problem—it will not correct a CO problem. While the alarm is silenced, it will continue to monitor the air for CO.

To Activate the Silence Feature: press and hold the Test/Silence/Scroll button until the horn is silent.

Once you activate the Silence Feature: the Silence cycle will last approximately 4 minutes.

- If CO levels drop below alarm levels after 4 minutes, the unit will return to normal operation and remain silent.
- If CO levels do not drop below alarm levels, the unit will alarm again.

⚠WARNING!

The Silence Feature is for your convenience only and will not correct a CO problem. Always check your home for a potential problem after any alarm. Failure to do so can result in injury or death.

⚠WARNING!

NEVER disconnect your CO Alarm to silence the horn. Use the Silence Feature. Unplugging the CO Alarm and removing the batteries removes your protection!

SILENCING THE LOW BATTERY WARNING

This silence feature can temporarily quiet the low battery warning "chirp" for up to 8 hours without having to remove the battery. You can silence the low battery warning "chirp" by pressing the Test/Silence button on the alarm cover.

Once the low battery warning "chirp" silence feature is activated, the unit continues to flash the red light once a minute for 8 hours; the word "bat" will flash on and off on the display. After 8 hours, the low battery "chirp" will resume. **Replace the battery as soon as possible, this unit will not operate without battery power!**

To deactivate this feature: Press the Test/Silence button again. The unit will go into Test Mode and the low battery warning will resume (LED flashes and unit sounds "chirp" once a minute.)

If you cannot silence the low battery warning, replace your battery immediately.

TESTING AND MAINTENANCE

WEEKLY TESTING

You can test this CO Alarm by pressing the Test/Silence/Scroll button on the Alarm cover until alarm sounds.

During testing, you will hear a loud alarm sequence – 4 beeps, pause, 4 beeps, pause.

⚠WARNING!

- **If the Alarm ever fails to test properly, replace it immediately. Products under warranty may be returned to the manufacturer for replacement. See "Limited Warranty" at the end of this manual.**
- **DO NOT stand close to the Alarm when the horn is sounding. Exposure at close range may be harmful to your hearing. When testing, step away when horn starts sounding.**
- **NEVER use vehicle exhaust! Exhaust may cause permanent damage and voids your warranty.**

REGULAR MAINTENANCE

To keep the CO Alarm working properly:

- Test it every week as described in "Weekly Testing."
- Vacuum the CO Alarm cover at least once a month, using the soft brush attachment. Never use water, cleaners, or solvents, since they may damage the unit. Test the Alarm again after vacuuming.
- Replace the battery immediately when you see/hear the "Low Battery Warning".

The Low (or Missing) Battery Warning:

The horn will "chirp" once a minute and the word "bat" will flash on and off on the display.

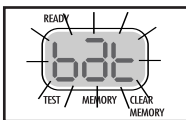

REPLACING THE BATTERY

Choosing a Replacement Battery:

This unit requires one standard 9V alkaline battery. The following alkaline batteries are acceptable as replacements: Duracell #MN1604 or MX1604; Eveready "Energizer" 522. You can also use an Ultralife 9 volt lithium battery #U9VL for longer service life between battery changes. These replacement batteries are commonly available at local retail stores.

IMPORTANT!

Use only the alkaline or lithium replacement batteries listed. The unit may not operate properly with other batteries. Never use rechargeable batteries since they may not provide a constant charge.

⚠CAUTION!

DO NOT spray cleaning chemicals or insect sprays directly on or near the CO Alarm. DO NOT paint over the CO Alarm. Doing so may cause permanent damage.

IMPORTANT!

Household cleaners, aerosol chemicals and other contaminants can affect the sensor. When using any of these materials near the CO Alarm, make sure the room is well ventilated.

IMPORTANT!

If your home is being fumigated, unplug the unit temporarily and put it where it will not be exposed to chemicals or fumes. When fumigation is complete and all traces of fumes clear, plug the unit back in and retest it.

WHAT YOU NEED TO KNOW ABOUT CO

WHAT IS CO?

CO is an invisible, odorless, tasteless gas produced when fossil fuels do not burn completely, or are exposed to heat (usually fire). Electrical appliances typically do not produce CO.

These fuels include: Wood, coal, charcoal, oil, natural gas, gasoline, kerosene, and propane.

Common appliances are often sources of CO. If they are not properly maintained, are improperly ventilated, or malfunction, CO levels can rise quickly. CO is a real danger now that homes are more energy efficient. "Air-tight" homes with added insulation, sealed windows, and other weatherproofing can "trap" CO inside.

SYMPTOMS OF CO POISONING

These symptoms are related to CO POISONING and should be discussed with ALL household members.

Mild Exposure:

Slight headache, nausea, vomiting, fatigue ("flu-like" symptoms).

Medium Exposure:

Throbbing headache, drowsiness, confusion, fast heart rate.

Extreme Exposure:

Convulsions, unconsciousness, heart and lung failure. Exposure to carbon monoxide can cause brain damage, death.

IMPORTANT!

This CO Alarm measures exposure to CO over time. It alarms if CO levels are extremely high in a short period of time, or if CO levels reach a certain minimum over a long period of time. The CO Alarm generally sounds an alarm before the onset of symptoms in average, healthy adults. Why is this important? Because you need to be warned of a potential CO problem while you can still react in time. In many reported cases of CO exposure, victims may be aware that they are not feeling well, but become disoriented and can no longer react well enough to exit the building or get help. Also, young children and pets may be the first affected. The average healthy adult might not feel any symptoms when the CO Alarm sounds. However, people with cardiac or respiratory problems, infants, unborn babies, pregnant mothers, or elderly people can be more quickly and severely affected by CO. If you experience even mild symptoms of CO poisoning, consult your doctor immediately!

FINDING THE SOURCE OF CO AFTER AN ALARM

Carbon monoxide is an odorless, invisible gas, which often makes it difficult to locate the source of CO after an alarm. These are a few of the factors that can make it difficult to locate sources of CO:

- House well ventilated before the investigator arrives.
- Problem caused by "backdrafting."
- Transient CO problem caused by special circumstances.

Because CO may dissipate by the time an investigator arrives, it may be difficult to locate the source of CO. **BRK Brands, Inc. shall not be obligated to pay for any carbon monoxide investigation or service call.**

POTENTIAL SOURCES OF CO IN THE HOME

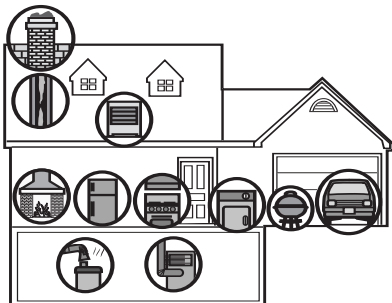

Fuel-burning appliances like: portable heater, gas or wood burning fireplace, gas kitchen range or cooktop, gas clothes dryer.

Damaged or insufficient venting: corroded or disconnected water heater vent pipe, leaking chimney pipe or flue, or cracked heat exchanger, blocked or clogged chimney opening.

Improper use of appliance/device: operating a barbecue grill or vehicle in an enclosed area (like a garage or screened porch).

Transient CO Problems: "transient" or on-again-off-again CO problems can be caused by outdoor conditions and other special circumstances.

The following conditions can result in transient CO situations:

1. Excessive spillage or reverse venting of fuel appliances caused by outdoor conditions such as:
 - Wind direction and/or velocity, including high, gusty winds. Heavy air in the vent pipes (cold/humid air with extended periods between cycles).
 - Negative pressure differential resulting from the use of exhaust fans.
 - Several appliances running at the same time competing for limited fresh air.
 - Vent pipe connections vibrating loose from clothes dryers, furnaces, or water heaters.
 - Obstructions in or unconventional vent pipe designs which can amplify the above situations.
2. Extended operation of unvented fuel burning devices (range, oven, fireplace).
3. Temperature inversions, which can trap exhaust close to the ground.
4. Car idling in an open or closed attached garage, or near a home.

These conditions are dangerous because they can trap exhaust in your home. Since these conditions can come and go, they are also hard to recreate during a CO investigation.

HOW CAN I PROTECT MY FAMILY?

A CO Alarm is an excellent means of protection. It monitors the air and sounds a loud alarm before Carbon Monoxide levels become threatening for average, healthy adults.

A CO Alarm is not a substitute for proper maintenance of home appliances.

To help prevent CO problems and reduce the risk of CO poisoning:

- Clean chimneys and flues yearly. Keep them free of debris, leaves, and nests for proper air flow. Also, have a professional check for rust and corrosion, cracks, or separations. These conditions can prevent proper air movement and cause backdrafting. Never "cap" or cover a chimney in any way that would block air flow.
- Test and maintain all fuel-burning equipment annually. Many local gas or oil companies and HVAC companies offer appliance inspections for a nominal fee.
- Make regular visual inspections of all fuel-burning appliances. Check appliances for excessive rust and scaling. Also check the flame on the burner and pilot lights. The flame should be blue. A yellow flame means fuel is not being burned completely and CO may be present. Keep the blower door on the furnace closed. Use vents or fans when they are available on all fuel-burning appliances. Make sure appliances are vented to the outside. Do not grill or barbecue indoors, or in garages or on screen porches.
- Check for exhaust backflow from CO sources. Check the draft hood on an operating furnace for a backdraft. Look for cracks on furnace heat exchangers.
- Check the house or garage on the other side of shared wall.
- Keep windows and doors open slightly. If you suspect that CO is escaping into your home, open a window or a door. Opening windows and doors can significantly decrease CO levels.

In addition, familiarize yourself with all enclosed materials. Read this manual in its entirety, and make sure you understand what to do if your CO Alarm sounds.

UNDERWRITERS LABORATORIES INC. UL2034

WHAT LEVELS OF CO CAUSE AN ALARM?

Underwriters Laboratories Inc. Standard UL2034 requires residential CO Alarms to sound when exposed to levels of CO and exposure times as described below. They are measured in parts per million (ppm) of CO over time (in minutes).

UL2034 Required Alarm Points*:

- If the alarm is exposed to 400 ppm of CO, IT MUST ALARM BETWEEN 4 and 15 MINUTES
- If the alarm is exposed to 150 ppm of CO, IT MUST ALARM BETWEEN 10 and 50 MINUTES.
- If the alarm is exposed to 70 ppm of CO, IT MUST ALARM BETWEEN 60 and 240 MINUTES.

* Approximately 10% COHb exposure at levels of 10% to 95% Relative Humidity (RH).

The unit is designed not to alarm when exposed to a constant level of 30 ppm for 30 days.

IMPORTANT!

CO Alarms are designed to alarm before there is an immediate life threat. Since you cannot see or smell CO, never assume it's not present.

- An exposure to 100 ppm of CO for 20 minutes may not affect average, healthy adults, but after 4 hours the same level may cause headaches.
- An exposure to 400 ppm of CO may cause headaches in average, healthy adults after 35 minutes, but can cause death after 2 hours.

Standards: Underwriters Laboratories Inc. Single and Multiple Station carbon monoxide alarms UL2034.

According to Underwriters Laboratories Inc. UL2034, Section 1-1.2: "Carbon monoxide alarms covered by these requirements are intended to respond to the presence of carbon monoxide from sources such as, but not limited to, exhaust from internal-combustion engines, abnormal operation of fuel-fired appliances, and fireplaces. CO Alarms are intended to alarm at carbon monoxide levels below those that could cause a loss of ability to react to the dangers of Carbon Monoxide exposure." This CO Alarm monitors the air at the Alarm, and is designed to alarm before CO levels become life threatening. This allows you precious time to leave the house and correct the problem. This is only possible if Alarms are located, installed, and maintained as described in this manual.

Gas Detection at Typical Temperature and Humidity Ranges: The CO Alarm is not formulated to detect CO levels below 30 ppm typically, UL tested for false alarm resistance to Methane (500 ppm), Butane (300 ppm), Heptane (500 ppm), Ethyl Acetate (200 ppm), Isopropyl Alcohol (200 ppm) and Carbon Dioxide (5000 ppm). Values measure gas and vapor concentrations in parts per million.

Audible Alarm: 85 dB minimum at 10 feet (3 meters).

FREQUENTLY ASKED QUESTIONS

Why doesn't the Alarm respond when I test it and the POWER/ALARM light is OFF?

The CO Alarm is not receiving power. It may not be plugged in all the way and the battery may be missing, low, or dead. Gently push the unit all the way into the outlet, and make sure the outlet is not controlled by a dimmer or switch. Check the battery.

Why does the word "bat" keep flashing on the display?

(You will also hear a "chirp" once a minute.) The battery is weak or missing. Install a new battery immediately.

Why is the word "bat" continuously displayed?

The unit is operating on battery back-up.

Why does the Alarm sound three rapid "chirps" every minute (MALFUNCTION SIGNAL)?

Make sure the battery is installed correctly. If the display reads "Err," replace the CO Alarm immediately. Units under warranty can be returned to the manufacturer for replacement. See Warranty for details.

Why does the alarm sound again about 4 minutes after I used the Silence Feature?

CO levels still indicate a potentially dangerous situation. Refer to "If Your CO Alarm Sounds" for details on how to respond to an alarm. If anyone is feeling ill, EVACUATE your home immediately.

Why does the CO Alarm sound frequently, but no high levels of CO are found in an investigation?

The CO Alarm may be improperly located. Try relocating your alarm. (Refer to "Where to Install CO Alarms.") If frequent alarms continue, have home rechecked for potential CO problems. You may be experiencing an intermittent CO problem.

GENERAL LIMITATIONS OF CO ALARMS

This CO Alarm is intended for residential use. It is not intended for use in industrial applications where Occupational Safety and Health Administration (OSHA) requirements for carbon monoxide detectors must be met.

CO alarms may not waken all individuals. If children or others do not readily waken to the sound of the CO alarm, or if there are infants or family members with mobility limitations, make sure that someone is assigned to assist them in the event of an emergency.

CO Alarms will not work without power. This CO Alarm requires a continuous supply of AC power. Plug into an unswitched 120V AC outlet only. The battery back-up is for emergency use only!

CO Alarms for Solar or Wind Energy users and battery backup power systems: AC powered CO Alarms should only be operated with true or pure sine wave inverters. Operating this CO Alarm with most battery-powered UPS (uninterruptible power supply) products or square wave or "quasi sine wave" inverters will damage the Alarm. If you are not sure about your inverter or UPS type, please consult with the manufacturer to verify.

This CO Alarm will not sense carbon monoxide that does not reach the sensor. This CO Alarm will only sense CO at the sensor. CO may be present in other areas. Doors or other obstructions may affect the rate at which CO reaches the CO Alarm. For this reason, if bedroom doors are usually closed at night, we recommend you install a CO Alarm in each bedroom and in the hallway between them.

CO Alarms may not sense CO on another level of the home. For example, a CO Alarm on the second level, near the bedrooms, may not sense CO in the basement. For this reason, one CO Alarm may not give adequate warning. Complete coverage is recommended. Place CO Alarms on each level of the home.

CO Alarms may not be heard. The alarm horn loudness meets or exceeds current UL standards of 85 dB at 10 feet (3 meters). However, if the CO Alarm is installed outside the bedroom, it may not wake up a sound sleeper or one who has recently used drugs or has been drinking alcoholic beverages. This is especially true if the door is closed or only partly open. Even persons who are awake may not hear the alarm horn if the sound is blocked by distance or closed doors. Noise from traffic, stereo, radio, television, air conditioner, or other appliances may also prevent alert persons from hearing the alarm horn. This CO Alarm is not intended for people who are hearing impaired.

CO Alarms are not a substitute for a smoke alarm. Although fire is a source of carbon monoxide, this CO Alarm does not sense smoke or fire. This CO Alarm senses CO that may be escaping unnoticed from malfunctioning furnaces, appliances, or other sources. Early warning of fire requires the installation of smoke alarms.

CO Alarms are not a substitute for life insurance. Though these CO Alarms warn against increasing CO levels, BRK Brands, Inc. does not warrant or imply in any way that they will protect lives from CO poisoning. Homeowners and renters must still insure their lives.

CO Alarms have a limited life. Although the CO Alarm and all of its parts have passed many stringent tests and are designed to be as reliable as possible, any of these parts could fail at any time. Therefore, you must test your CO Alarm weekly.

CO Alarms are not foolproof. Like all other electronic devices, CO Alarms have limitations. They can only detect CO that reaches their sensors. They may not give early warning to rising CO levels if the CO is coming from a remote part of the home, away from the CO Alarm.

6 Year End of Life Timer. Every 24 hours of operation a counter stored in memory is updated. When the count equals 6 years of true operation, meaning actually powered-up, a malfunction chirp (triple chirp) will sound once a minute at the time of the 45 second Power-LED flash.

LIMITED WARRANTY

BRK Brands, Inc. ("BRK") the maker of First Alert® brand products, warrants that for a period of 5 years from the date of purchase, this product will be free from defects in material and workmanship. BRK, at its option, will repair or replace this product or any component of the product found to be defective during the warranty period. Replacement will be made with a new or remanufactured product or component. If the product is no longer available, replacement may be made with a similar product of equal or greater value. This is your exclusive warranty.

This warranty is valid for the original retail purchaser from the date of initial retail purchase and is not transferable. Keep the original sales receipt. Proof of purchase is required to obtain warranty performance. BRK dealers, service centers, or retail stores selling BRK products do not have the right to alter, modify or any way change the terms and conditions of this warranty.

This warranty does not cover normal wear of parts or damage resulting from any of the following: negligent use or misuse of the product, use on improper voltage or current, use contrary to the operating instructions, disassembly, repair or alteration by anyone other than BRK or an authorized service center. Further, the warranty does not cover acts of God, such as fire, flood, hurricanes and tornadoes or any batteries that are included with this unit.

BRK shall not be liable for any incidental or consequential damages caused by the breach of any express or implied warranty. Except to the extent prohibited by applicable law, any implied warranty of merchantability or fitness for a particular purpose is limited in duration to the duration of the above warranty. Some states, provinces, or jurisdictions do not allow the exclusion or limitation of incidental or consequential damages or limitations on how long an implied warranty lasts, so the above limitations or exclusion may not apply to you. This warranty gives you specific legal rights, and you may also have other rights that vary from state to state, or province to province.

How to Obtain Warranty Service:

Service: If service is required, do not return the product to your retailer. In order to obtain warranty service, contact the Consumer Affairs Division at 1-800-323-9005, 7:30 AM to 5:00 PM, Central Standard Time, Monday through Friday. To assist in serving you, please have the model number and date of purchase available when calling. **For Warranty Service return to:** BRK Brands, Inc., 25 Spur Drive, El Paso, TX 79906

Battery: BRK Brands, Inc. make no warranty, express or implied, written or oral, including that of merchantability or fitness for any particular purpose with respect to battery.

For your records, please record:

Date Purchased: _____ Where Purchased: _____

Date Installed: _____ / _____ Month/Year

Replacement date is five years after installation: _____ / _____
Month/Year

NOTE: End of Life Signal — Once the unit reaches the end of its lifecycle, the MALFUNCTION SIGNAL will sound once a minute to indicate the need to immediately replace the Alarm.

First Alert® is a registered trademark of the First Alert Trust.

Free Manuals Download Website

<http://myh66.com>

<http://usermanuals.us>

<http://www.somanuals.com>

<http://www.4manuals.cc>

<http://www.manual-lib.com>

<http://www.404manual.com>

<http://www.luxmanual.com>

<http://aubethermostatmanual.com>

Golf course search by state

<http://golfingnear.com>

Email search by domain

<http://emailbydomain.com>

Auto manuals search

<http://auto.somanuals.com>

TV manuals search

<http://tv.somanuals.com>