

OPERATING INSTRUCTIONS

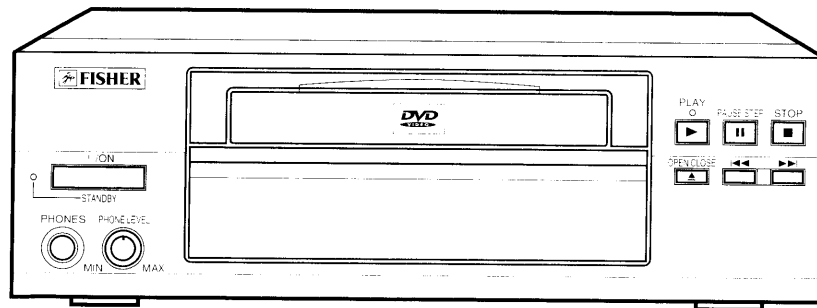

DVD-S1000

DVD Video Player
with REM-S1000
Wireless Remote Control

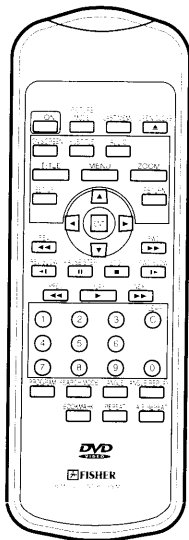

FISHER'S HELP-LINE

Call the toll-free number below if you have any difficulties operating this product.
1-800-421-5013 (weekdays 8:00 AM - 5:00 PM, Pacific time)

CONTENTS

Accessories	E1	Frame by Frame Advance Playback	E16
Safety Certification	E2	Zoom Feature	E16
Controls	E3	Viewing from a Desired Camera Angle (Multi-Angle)	E17
Remote Controls	E4	Angle Replay	E17
Basic Connections	E5	Normal Repeat Play	E18
Connecting to a TV (Example 1)	E5	Designated Range Repeat Play (A-B Repeat)	E18
Additional Connections Examples	E6	Return button (RETURN) for Video CD	E18
Connecting to an Audio System and TV (Example 2)	E6	Programmed Play	E19
Connecting to an AV System with		Storing Bookmarks in Memory	
Dolby Pro Logic Decoder (Example 3)	E7	to be Viewed (listened to) Again	E20
Connecting to an AV Amplifier with		Selecting a Title Menu	E21
Dolby Digital (AC-3) Decoder (Example 4)	E8	Selecting a DVD Menu	E21
Connecting to an Amplifier with		Selecting Subtitle Language	E22
a DTS Decoder (Example 5)	E9	Selecting Audio Soundtrack Language	
Connecting to a Digital Amplifier (Example 6)	E9	(Multi-Language)	E22
For Safe and Efficient Operation	E10	Selecting Picture Mode	E23
Playable Discs	E11	Selecting Display Mode	E23
Basic Operation	E12	Initial Settings	E24
Before Starting	E12	Common procedures of initial settings	E24
Basic Playback	E12	Language	E24
Stopping Play	E13	Display	E25
Continuing Playback from Where You		Audio	E25
Stopped Watching (LAST MEMO PLAY)	E13	Parental	E26
Chapter (Track) Skip Forward/Skip Back	E14	Language Code List	E27
Title/Chapter (Track) Search	E14	Troubleshooting Guide	E28
Time Search	E14	Maintenance	E29
Fast Playback	E15	Specifications	E29
Slow Motion Playback	E15	Warranty	E30
Still Picture (Pause)	E16		

IMPORTANT INFORMATION:

Before you connect this DVD video player to your TV, please check your TV first. You need the TV with the Audio/Video input jacks at least. Please refer to "BASIC CONNECTIONS".

ACCESSORIES

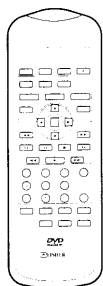

REM-S1000 wireless remote control
Part No. 645 037 3961

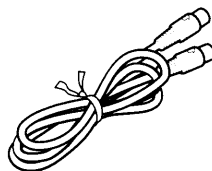

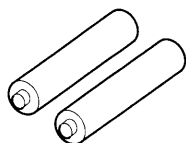

S-video cable
Part No. 645 037 3909



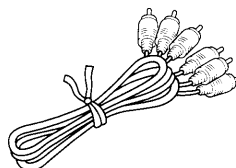

AA size battery (manganese)
Part No. 645 001 8381
(1.5 volt)
Quantity: 1 pair

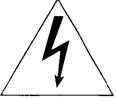

Audio/Video cable
Part No. 645 037 3893

	CAUTION RISK OF ELECTRIC SHOCK DO NOT OPEN	
CAUTION: TO PREVENT THE RISK OF ELECTRIC SHOCK, DO NOT REMOVE COVER (OR BACK). NO USER-SERVICEABLE PARTS INSIDE. REFER SERVICING TO QUALIFIED SERVICE PERSONNEL.		

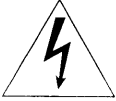
WARNING: TO PREVENT FIRE OR SHOCK HAZARD, DO NOT EXPOSE THIS APPLIANCE TO RAIN OR MOISTURE.

	This symbol indicates that dangerous voltage constituting a risk of electric shock is present within this unit.
	This symbol indicates that there are important operating and maintenance instructions in the literature accompanying this unit.

WARNING: UNAUTHORIZED RECORDING OF COPYRIGHTED MATERIAL MAY VIOLATE APPLICABLE COPYRIGHT LAWS. THE MANUFACTURER ASSUMES NO RESPONSIBILITY FOR UNAUTHORIZED DUPLICATION, USE OR OTHER ACTS WHICH INFRINGE UPON THE RIGHTS OF COPYRIGHT OWNERS.

SAFETY CERTIFICATION

This unit is made and tested to meet exacting safety standards. It meets UL and FCC requirements and complies with safety performance standards of the U.S. Department of Health and Human Services.

CAUTION - USE OF CONTROLS OR ADJUSTMENTS OR PERFORMANCE OF PROCEDURES OTHER THAN THOSE SPECIFIED HEREIN MAY RESULT IN HAZARDOUS RADIATION EXPOSURE.

THIS UNIT SHOULD NOT BE ADJUSTED OR REPAIRED BY ANYONE EXCEPT PROPERLY QUALIFIED SERVICE PERSONNEL.



FCC INFORMATION

This device complies with Part 15 of the FCC Rules. Operation is subject to the following two conditions: (1) This device may not cause harmful interference, and (2) this device must accept any interference received, including interference that may cause undesired operation.

CAUTION:

Changes or modifications not expressly approved by Fisher may void the user's authority to operate this equipment.

NOTE:

This equipment has been tested and found to comply with the limits for a Class B digital device, pursuant to Part 15 of the FCC Rules. These limits are designed to provide reasonable protection against harmful interference in a residential installation. This equipment generates, uses and can radiate radio frequency energy and, if not installed and used in accordance with the instructions, may cause harmful interference to radio communications. However, there is no guarantee that interference will not occur in a particular installation. If this equipment does cause harmful interference to radio or television reception, which can be determined by turning the equipment off and on, the user is encouraged to try to correct the interference by one or more of the following measures:

- Reorient or relocate the receiving antenna.
- Increase the separation between the equipment and receiver.
- Connect the equipment into an outlet on a circuit different from that to which the receiver is connected.
- Consult the dealer or an experienced radio/TV technician for help.

CONTROLS

Front panel

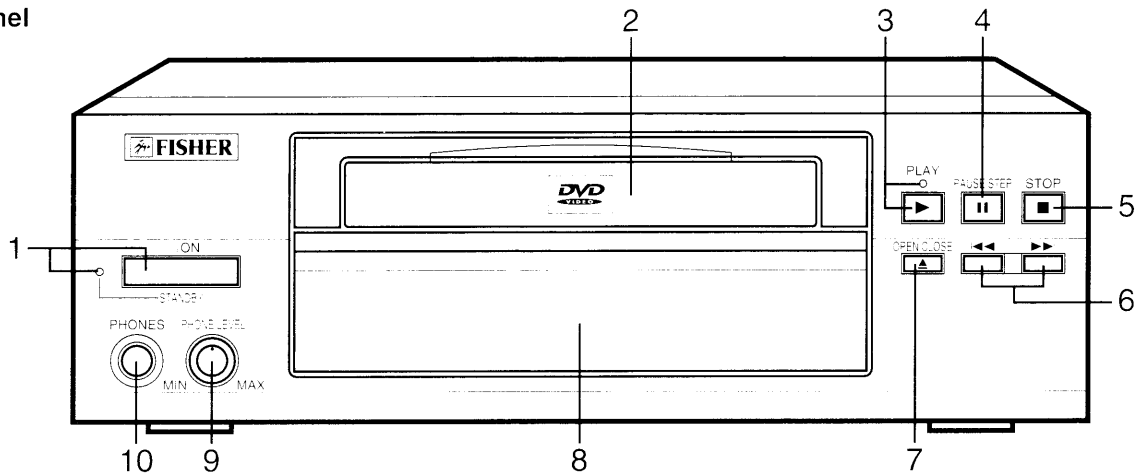

- | | |
|---|---|
| 1. Power button/Standby indicator (ON, STANDBY) | 6. Skip/Next/Previous buttons (◀◀, ▶▶) |
| 2. Disc tray | 7. Open/Close button (OPEN/CLOSE) |
| 3. Play button/indicator (PLAY) | 8. Display |
| 4. Pause/Step button (PAUSE/STEP) | 9. Headphone volume control (PHONE LEVEL) |
| 5. Stop button (STOP) | 10. Stereo headphones jack (PHONES) |

Display

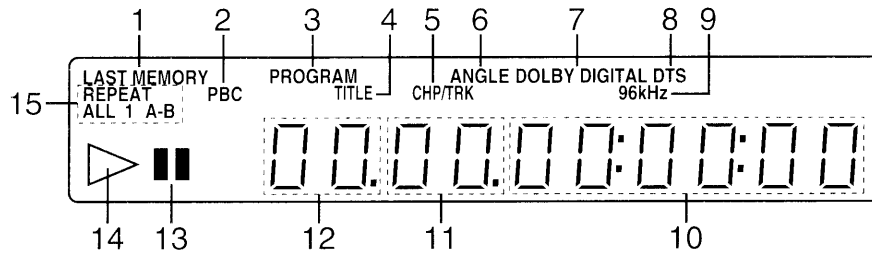

- | | |
|--|---|
| 1. Last memory indicator (LAST MEMO) | 9. PCM 96kHz sampling frequency indicator (96kHz) |
| 2. Playback control indicator for Video CD (PBC) | 10. Elapsed and Remaining playing time indicator |
| 3. Program indicator (PROGRAM) | 11. Chapter and Track number indicator |
| 4. Title indicator (TITLE) | 12. Title number indicator |
| 5. Chapter/Track indicator (CHP/TRK) | 13. Pause indicator () |
| 6. Angle indicator (ANGLE) | 14. Play indicator (▶) |
| 7. Dolby Digital indicator (DOLBY DIGITAL) | 15. Repeat mode indicators (REPEAT, ALL, 1, A-B) |
| 8. DTS indicator (DTS) | |

Rear Panel

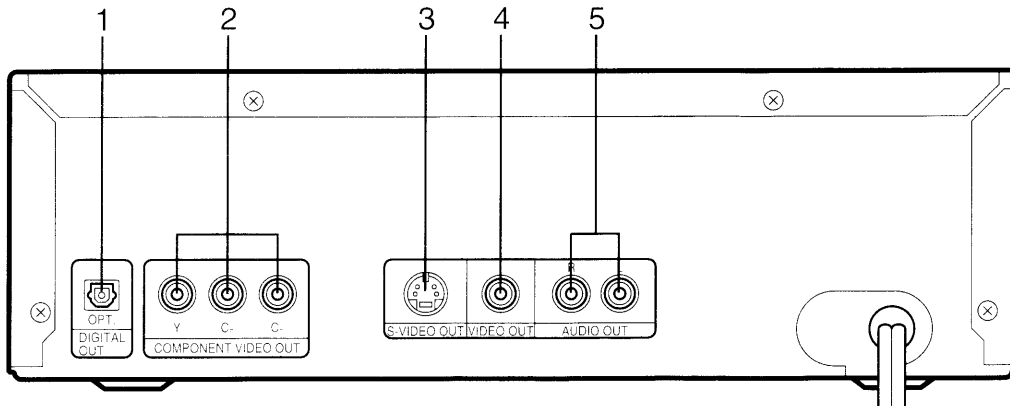

- | | |
|---|-----------------------------------|
| 1. Optical digital output jack (DIGITAL OUT) | 4. Video output jack (VIDEO OUT) |
| 2. Component video output jacks (COMPONENT VIDEO OUT) | 5. Audio output jacks (AUDIO OUT) |
| 3. S-Video output jack (S-VIDEO OUT) | |

REMOTE CONTROLS

Controls

1. Power button (ON/OFF)
2. Picture mode button (PICTURE MODE)
3. Last memory (LAST MEMO)
4. Open/Close button (OPEN/CLOSE)
5. Audio button (AUDIO)
6. Zoom button (ZOOM)
7. Return button (RETURN)
8. Directional arrow buttons (▲, ►, ▼, ◀)
9. Enter button (ENT)
10. Forward button (FWD)
11. Forward slow button (FWD SLOW)
12. Stop button (STOP)
13. Skip/Next button (NEXT)
14. Clear button (CLEAR)
15. Number buttons (1 - 9, 0)
16. Angle replay button (ANGLE REPLAY)
17. Angle button (ANGLE)
18. A-B repeat button (A-B REPEAT)
19. Repeat button (REPEAT)
20. Bookmark button (BOOKMARK)
21. Search mode button (SEARCH MODE)
22. Program button (PROGRAM)
23. Play button (PLAY)
24. Skip/Previous button (PREV)
25. Pause/Step button (PAUSE/STEP)
26. Reverse slow button (REV SLOW)
27. Reverse button (REV)
28. Set up button (SET UP)
29. Menu button (MENU)
30. Title button (TITLE)
31. Subtitle button (SUBTITLE)
32. On screen display button (ON SCREEN)

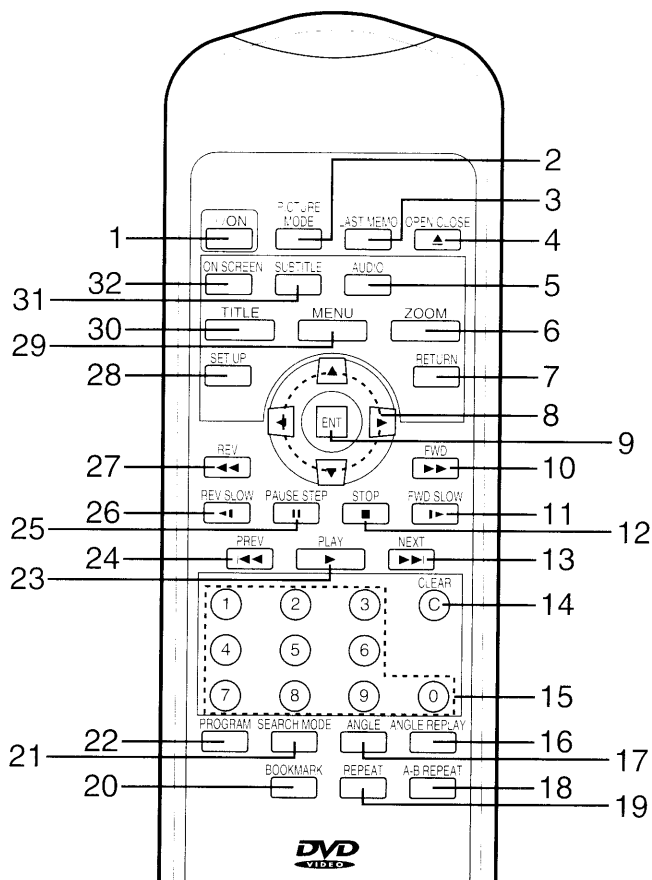

Inserting batteries

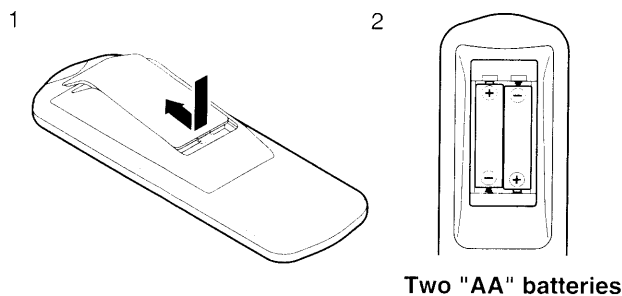

NOTE:
Remove the batteries if the remote control is not to be used for a month or more. Batteries left in the unit may leak and cause damage.

IMPORTANT NOTE:

SPENT OR DISCHARGED BATTERIES MUST BE RECYCLED OR DISPOSED OF PROPERLY IN COMPLIANCE WITH ALL APPLICABLE LAWS. FOR DETAILED INFORMATION, CONTACT YOUR LOCAL COUNTY SOLID WASTE AUTHORITY.

Remote control range

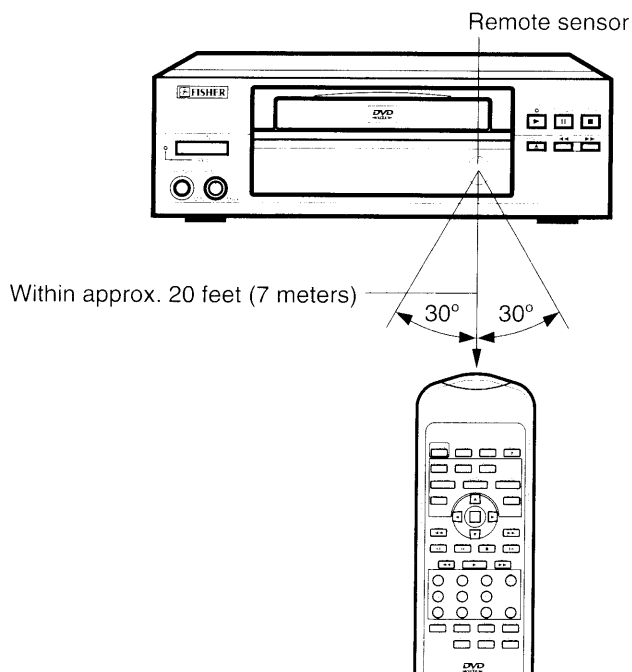

BASIC CONNECTIONS

Connecting to a TV (Example 1)

Connect the DVD video player to your TV.
This is the easiest way to hook up the DVD video player.

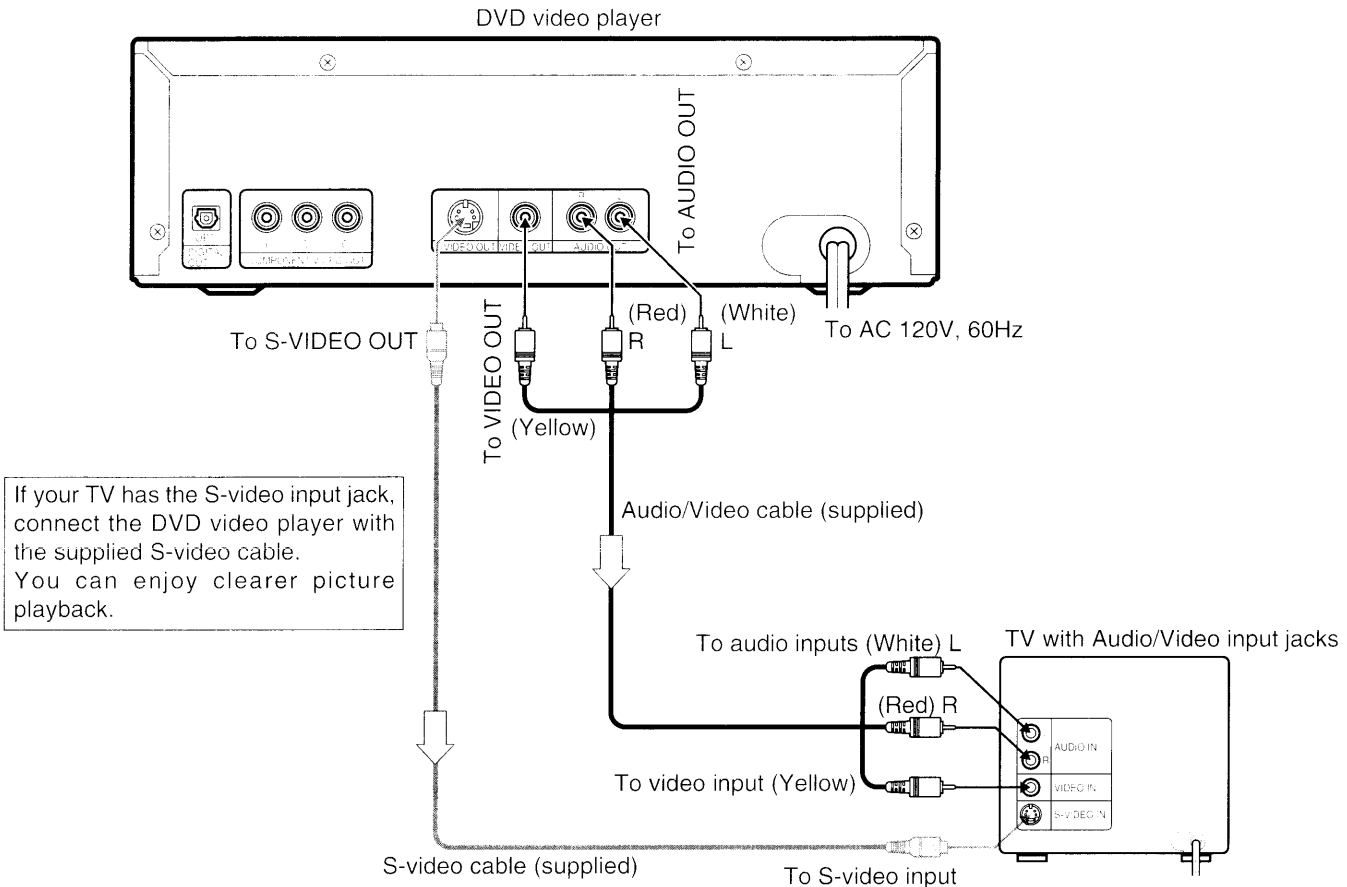

Notes:

- Please refer to the instruction manual with the TV.
- When you connect the DVD video player to your TV, be sure to turn off the power and disconnect both units from the wall outlet until all the connections have been made.
- If your TV has one audio input jack, connect the DVD video player to a Y cable adapter (not supplied) and then connect it to the TV. Please consult your local audio/video dealer.
- Do not connect the DVD video player to a VCR directly. The playback picture will be distorted because DVD video discs are copy protected.

If your TV has the component video input jacks, connect the DVD video player to these jacks, instead of the VIDEO OUT or S-VIDEO OUT jacks. You can enjoy high quality picture playback.

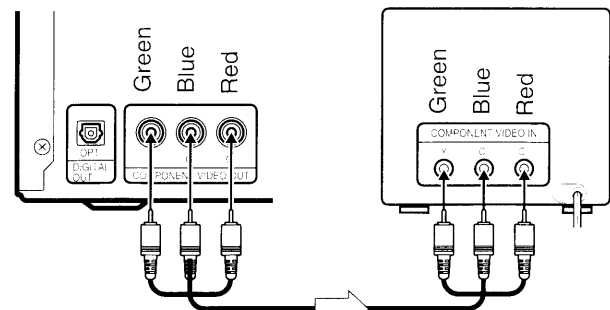

*Component video cable (not supplied)

*Please consult your local audio/video dealer.

ADDITIONAL CONNECTIONS EXAMPLES

Connecting to an Audio System and TV (Example 2)

Connect the DVD video player to an Audio System and TV.

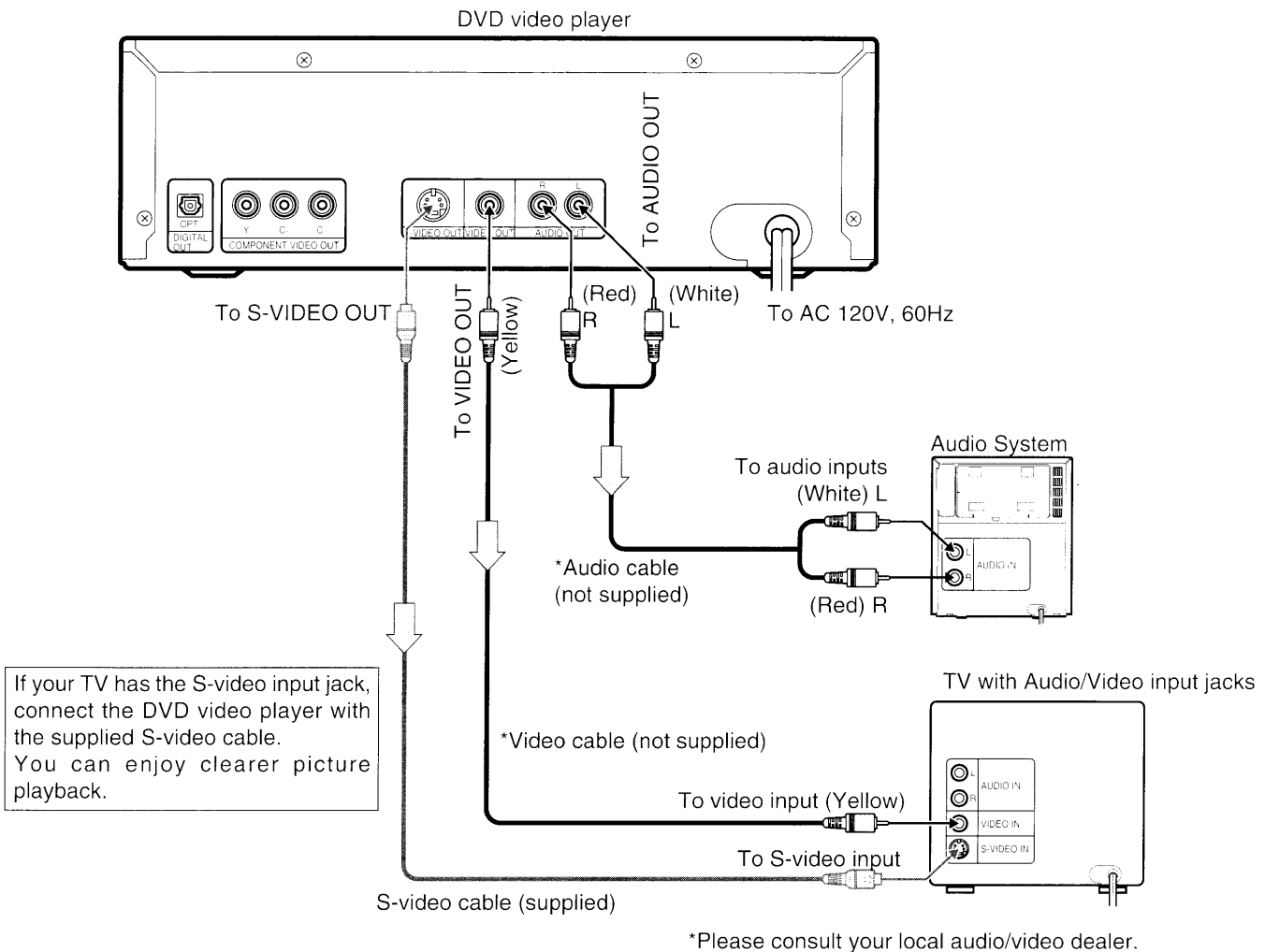

Notes:

- Please refer to the instruction manuals with the Audio System and TV.
- When you connect the DVD video player to other equipment, be sure to turn off the power and disconnect all of the equipment from the wall outlet until all the connections have been made.
- If your TV has one audio input jack, connect the DVD video player to a Y cable adapter (not supplied) and then connect it to the TV. Please consult your local audio/video dealer.
- Do not connect the DVD video player to a VCR directly. The playback picture will be distorted because DVD video discs are copy protected.

If your TV has the component video input jacks, connect the DVD video player to these jacks, instead of the VIDEO OUT or S-VIDEO OUT jacks. You can enjoy high quality picture playback.

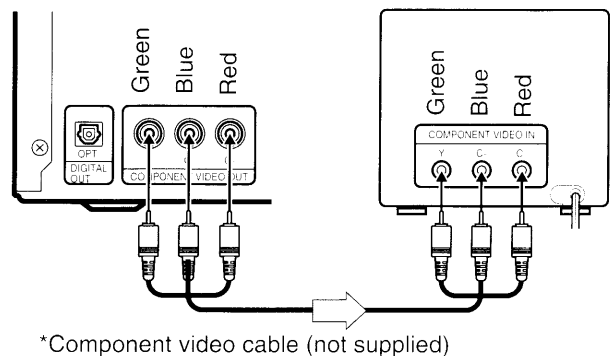

*Please consult your local audio/video dealer.

Connecting to an AV System with Dolby Pro Logic Decoder (Example 3)

If your AV System has a Dolby Pro Logic decoder, please refer to the following example connection.

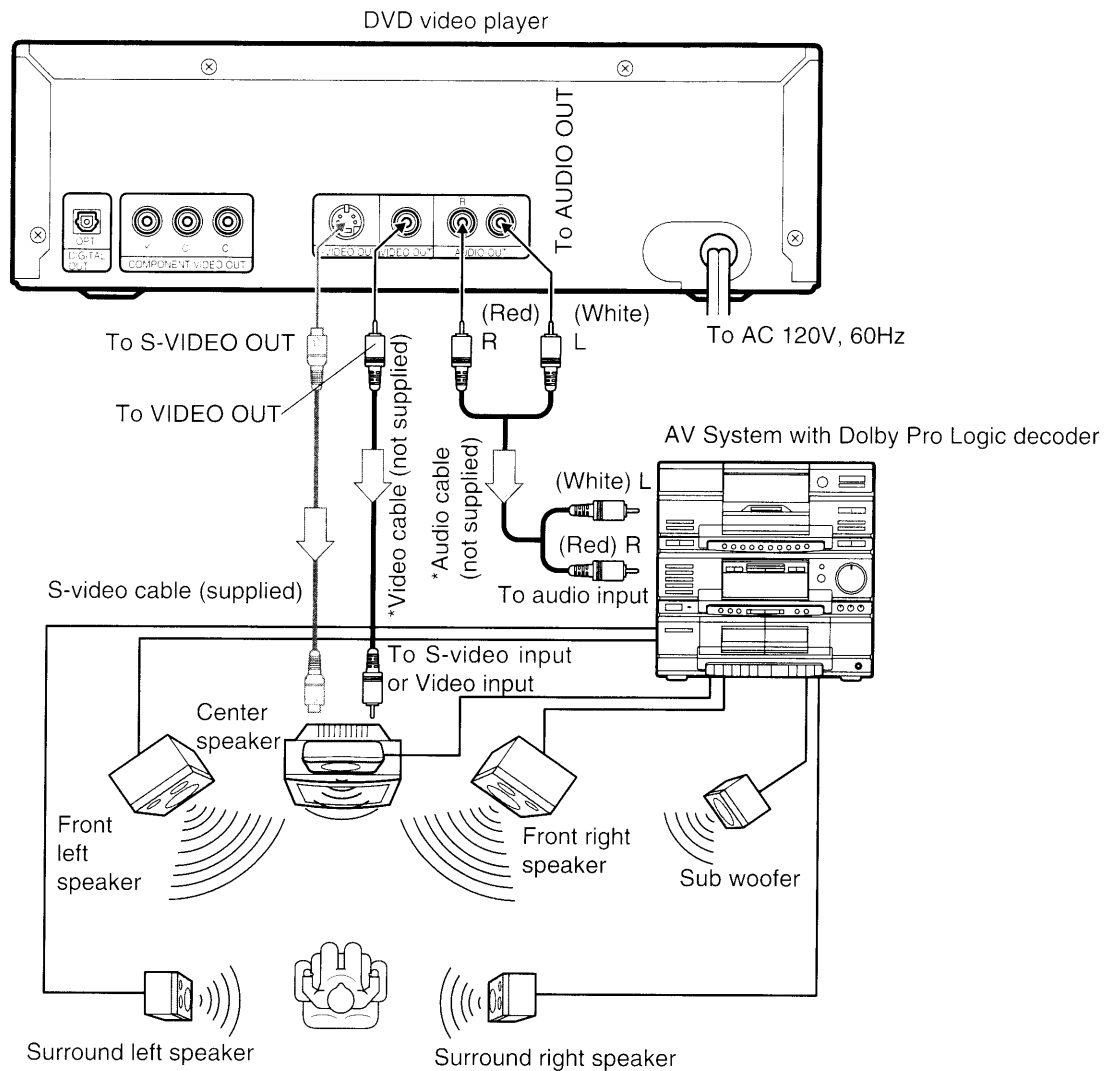

*Please consult your local audio/video dealer.

Notes:

- Please refer to the instruction manual with your AV System.
- Please refer to "BASIC CONNECTIONS" too.
- When you connect the DVD video player to your AV System, be sure to turn off the power and disconnect both units from the wall outlet until all the connections have been made.

Connecting to an AV Amplifier with Dolby Digital (AC-3) Decoder (Example 4)

You can enjoy the surround sound that DVD video discs recorded in Dolby Digital.

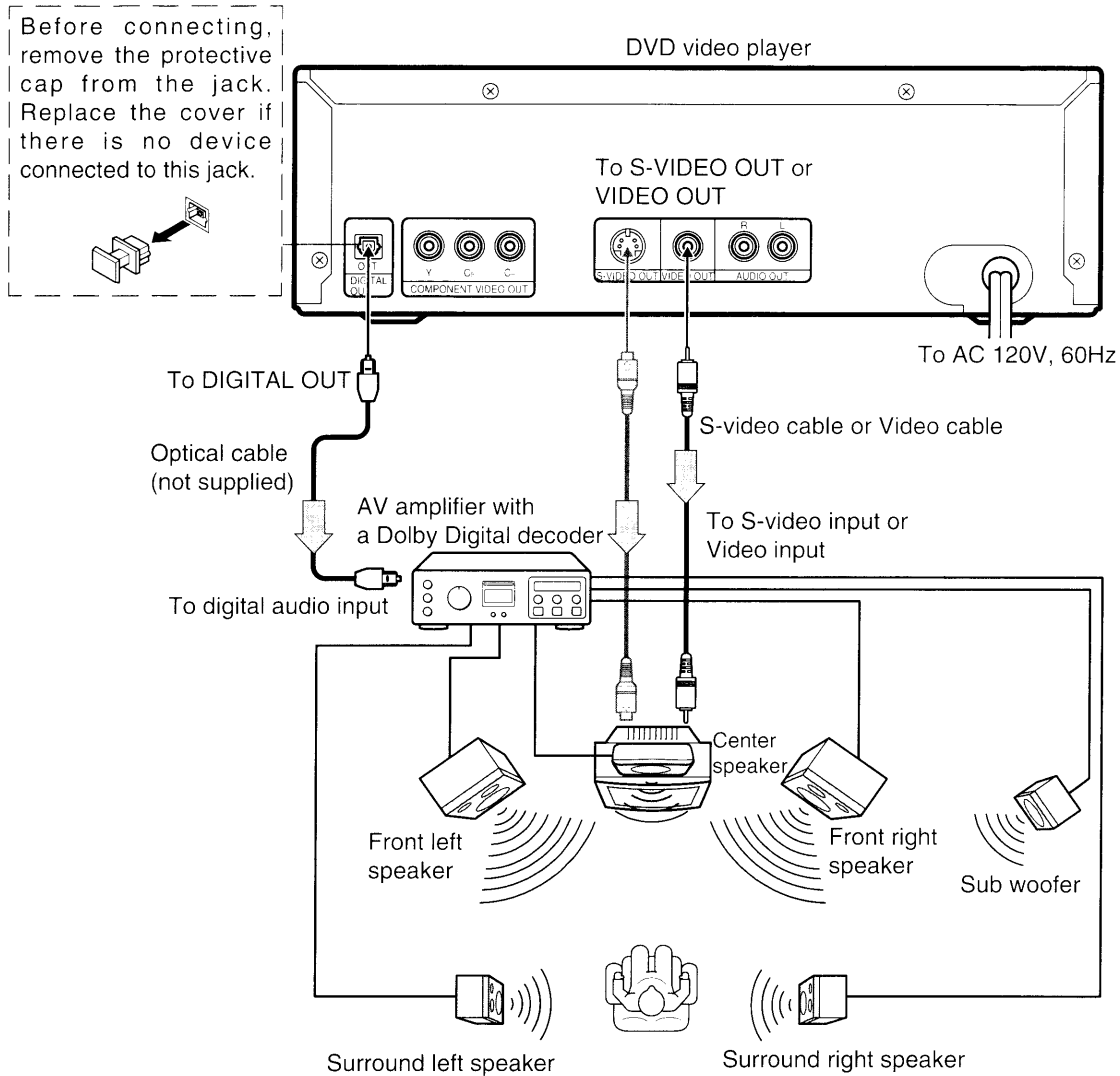

Notes:

- Please refer to the instruction manual with your AV amplifier.
- Please refer to "BASIC CONNECTIONS" too.
- When you connect the DVD video player to your amplifier, be sure to turn off the power and disconnect both units from the wall outlet until all the connections have been made.

Manufactured under license form Dolby Laboratories. "Dolby", "AC-3" and the double-D symbol are trademarks of Dolby Laboratories. Confidential Unpublished Works. ©1992-1997 Dolby Laboratories, Inc. All rights reserved.

Connecting to an Amplifier with a DTS Decoder (Example 5)

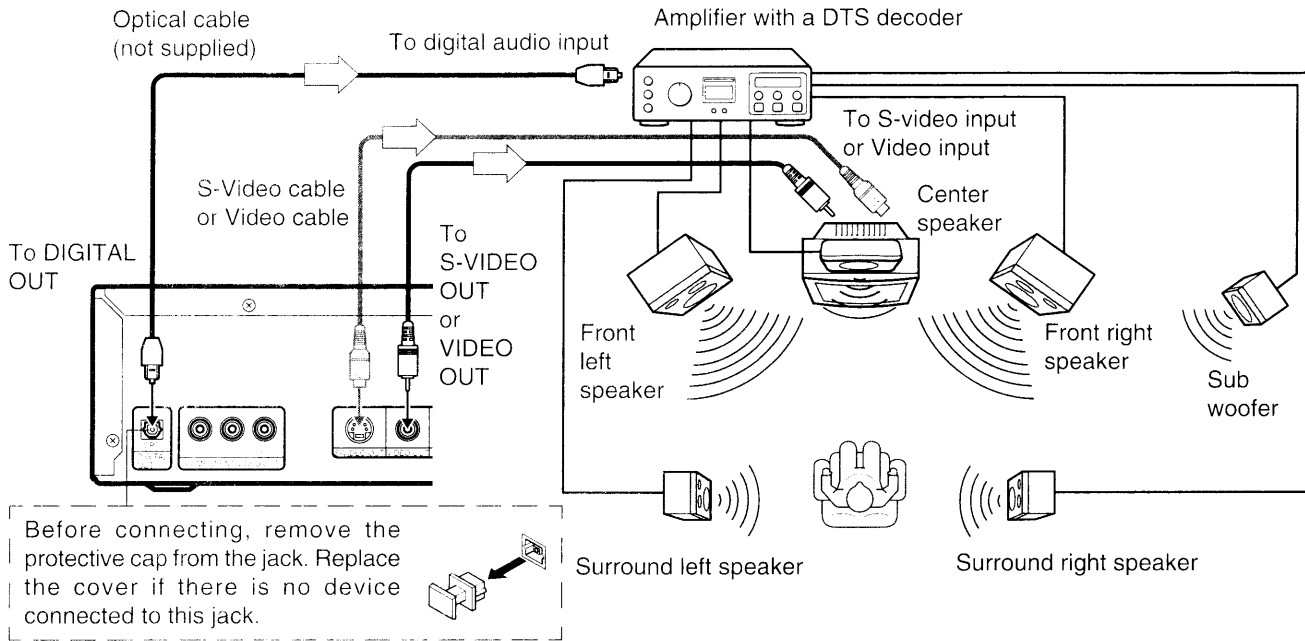

Notes:

- Please refer to the instruction manual with your amplifier.
- Please refer to "BASIC CONNECTIONS" too.
- When you connect the DVD video player to your amplifier, be sure to turn off the power and disconnect both units from the wall outlet until all the connections have been made.

The term DTS Digital Out is a trademark of Digital Theater Systems, Inc.

Connecting to a Digital Amplifier (Example 6)

You can enjoy 2 Channel Digital Stereo Sound.

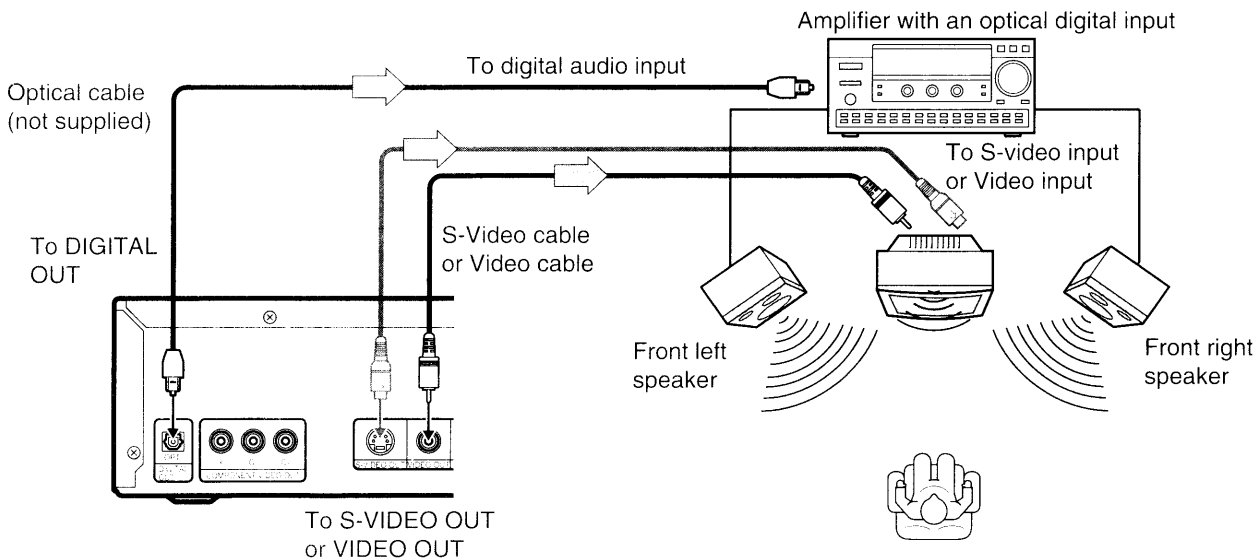

Notes:

- Please refer to the instruction manual with your amplifier.
- Please refer to "BASIC CONNECTIONS" too.
- When you connect the DVD video player to your amplifier, be sure to turn off the power and disconnect both units from the wall outlet until all the connections have been made.

Listening with Headphones

Connect a pair of stereo headphones with a 1/4" plug (not available from FISHER) to the PHONES jack for monitoring or for private listening.

- Set the PHONE LEVEL control to the "MIN" position before connecting the headphones.

Use the PHONE LEVEL control to adjust the volume of the headphones. Turn the control counterclockwise to decrease the volume, clockwise to increase it.

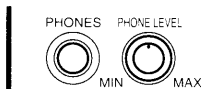

CAUTION:

Do not use the headphones for extended periods of time with the volume high. Doing so may damage your hearing.

Power supply

Connect the power cord to a 120VAC 60Hz outlet. This unit is equipped with a polarized plug. If you have difficulty inserting the plug, turn it over and reinsert it. If the unit will not be used for a long time, disconnect the AC plug from the AC outlet.

NOTES:

- Before plugging the power cord into an AC outlet, make sure that all the connections have been made.
- The unit is not disconnected from the AC power unless the power cord is unplugged from the AC outlet.

CAUTION:

When connecting the DVD video player, follow the installation instructions described in the attached "IMPORTANT SAFETY INSTRUCTIONS".





FOR SAFE AND EFFICIENT OPERATION

- Do not damage the power cord.
- When not in use, disconnect the power cord from the outlet. Grasp the plug, not the cord, when disconnecting the unit.
- If water should enter the unit, electrical shock or a malfunction may result. Use in an area where there is low humidity and little dust.
- Do not disassemble or alter the unit in any way.
- Do not use the unit in areas where extremes in temperature occur (below 40°F (5°C) or exceeding 95°F (35°C)), or where it may be exposed to direct sunlight.
- Because of the DVD video player extremely low noise and wide dynamic range, there is a tendency to set the volume on the amplifier higher than necessary. Doing so may produce an excessively high output from the amplifier which can cause damage to your speakers. Please be careful in this regard.
- Sudden changes in the surrounding temperature can cause dew to form on the optical pickup lens inside the unit. Under this condition the unit may be unable to operate properly. If this should occur, remove the disc and allow the unit to adjust to the surrounding temperature.
- **When carrying the unit, be sure to remove any discs which may be inside and turn the power off. Then unplug the power cord from the AC outlet after 10 seconds. Carrying the unit with any discs inside may damage the disc and/or the unit.**

Press [OPEN/CLOSE] when closing the disc tray.
Do not push the disc tray.

PLAYABLE DISCS

The following types of discs can be played on this unit.

Disc type and logo mark		Recorded content	Disc size	Maximum playing time
DVD Video		Audio + Video	5 inches (12 cm)	Approx. 4 hours (Single sided disc) Approx. 8 hours (Double sided disc)
			3 inches (8 cm)	Approx. 80 minutes (Single sided disc) Approx. 160 minutes (Double sided disc)
Video CD	  (Version 2.0)	Audio + Video	5 inches (12 cm)	74 minutes
			3 inches (8 cm)	20 minutes
Music CD		Audio	5 inches (12 cm)	74 minutes
			3 inches (8 cm)	20 minutes

Region number

Region number (Regional restriction code) is built-in to the DVD video player and DVD video discs.

Region number "1" or "ALL" of DVD video discs can be used on this unit.



CAUTION:

- Only the above types of discs can be played on this unit. DVD-ROM, CD-ROM, CD-R, SVCD, etc. cannot be played.
- This unit is to be used exclusively with the NTSC color system. PAL and SECAM system discs cannot be used with this unit.

DVD Video Disc

There are the marks on some DVD video disc package.

Examples:



Multiple Languages



Multi-language subtitles



Multi-Angle

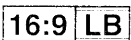

Multi-Aspect



Region number

DVD Video Disc

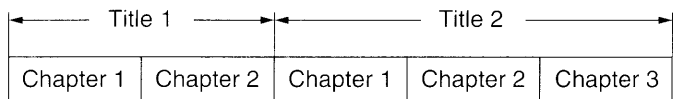

DVD video discs are divided into titles, and the titles are sub-divided into chapters.

Video CD/Music CD Disc

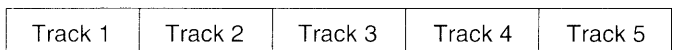

Video CD and Music CD discs are divided into tracks.

Handling, Storing and Cleaning Discs

- Fingerprints and dust should be carefully wiped from the signal surface of the disc (glossy side) with a soft cloth. Wipe in a straight motion from the center to the outside of the disc.
- Never use chemicals such as record cleaning sprays, antistatic sprays or fluids, benzene or thinner to clean compact discs. These chemicals will permanently damage the plastic surface of the disc.
- To remove a disc from its storage case, press down on the center of the case and lift the disc out, holding it carefully by the edges.

- Discs should be returned to their cases after use to protect them from dust and scratches.
- To prevent warping the disc, do not expose it to direct sunlight, high humidity or high temperatures for extended periods of time.
- Do not apply paper or write anything on either side of the disc. Sharp writing instruments, or the inks used in some felt-tip pens, may damage the surfaces of the disc.

BASIC OPERATION

Before Starting

- Turn on the power (TV, Audio System, AV amplifier, etc.).
- Select the video input source.
- Select the playback picture size according to the aspect ratio of the TV.
- Select the audio input source.

Basic Playback

Notes:

- Do not touch the disc tray while it is moving.
- Never place anything except a disc on the disc tray. Foreign objects can damage the unit.
- Do not apply excessive force to the disc tray.
- Discs must be placed on the disc tray one at a time.

When operation buttons are pressed, that operation is displayed on the TV screen. The display turns off after several seconds.

1. Press [POWER].
 - The STANDBY indicator turns off.
 - "FISHER" logo appears on the TV screen.
 - "READING" appears on the display, then "READING" is replaced by "NO DISC".

2. Press [OPEN/CLOSE].
 - "OPEN" appears and the disc tray opens.

Note:

To open or close the disc tray, be sure to use [OPEN/CLOSE]. Do not press the disc tray with your hand.

3. Place the disc with the label facing up on the disc tray.

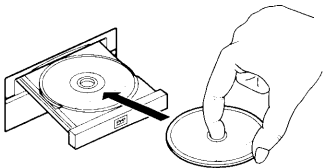

For 5-inch (12cm) disc

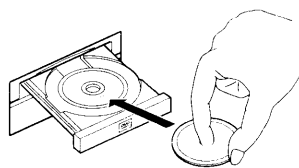

For 3-inch (8cm) disc

4. Press [PLAY].

The disc tray closes.

- "READING" appears on the display.
- Playback starts automatically. "Play ►" briefly appears on the screen.
- "►" appears on the display and the PLAY indicator lights.

Note:

If the disc is loaded with the label side downward (and it is a single sided disc), or if a badly scratched disc is loaded, "NO DISC" (or "DISC ERROR" or "NO PLAY") appears. If this occurs, load the disc correctly or replace the disc.

Important Note:

- This instruction manual explains the basic instruction of this DVD video player using the remote control unit.
- Some DVD video or Video CD discs have different functions that may not be explained in this instruction manual. You may be needed extra instructions. In this case, please follow the instructions displayed on the TV screen or jacket or case of the disc.
- "⊘" may appear on the TV screen during operation. This icon means that the function is not available on the disc now.

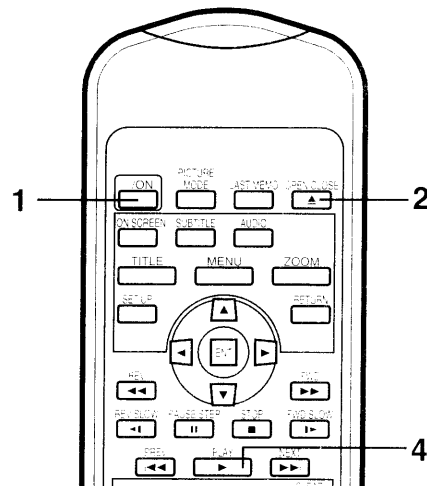
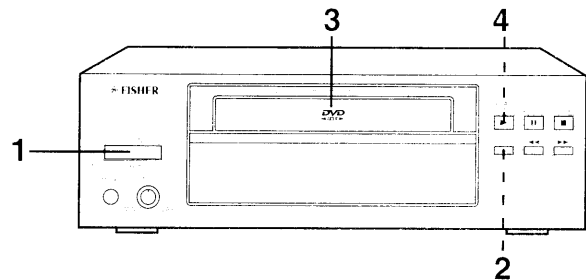

If a menu screen appears on the TV screen...

Press [▲], [▶], [▼] or [◀] (or the number buttons), then press [ENT] to select the desired item.

Playback of the selected item will start.

Note:

For more details, please refer to the jacket or case of the disc.

Stopping Play

Press [STOP] during playback.

The player memories the point where you stopped.

- "Stop" appears.

If you press [PLAY] again, playback starts automatically from the point where you stopped. (Resuming Playback)

Notes:

- Some discs may not start resuming playback.
- If [STOP] is pressed twice, the player stops completely.

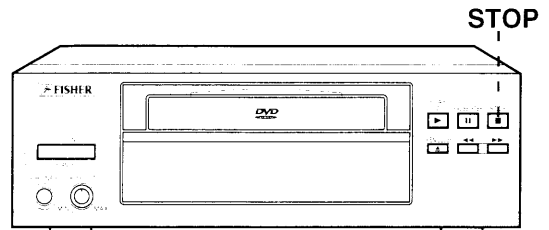

Continuing Playback from Where You Stopped Watching (LAST MEMO PLAY)

Note:

You must set "LastMemo Play: ON" first. (See page E25.)

1. Press [LAST MEMO] to stop playback.
"Last Memo" briefly appears on the screen.
"LAST MEMORY" appears on the display.
2. Press [OPEN/CLOSE] to open the disc tray to change the disc, or press [ON/OFF] to turn off the power.
3. Road the disc and press [PLAY], or press [ON/OFF] again.
"Last Memo Play" briefly appears on the screen.
Playback resumes from the point where you stopped. (The memory is released.)
If desired, press [LAST MEMO] again.

Notes:

- Points on up to 5 discs can be memorized.
- The Last Memo Play mode may not work correctly with some discs.

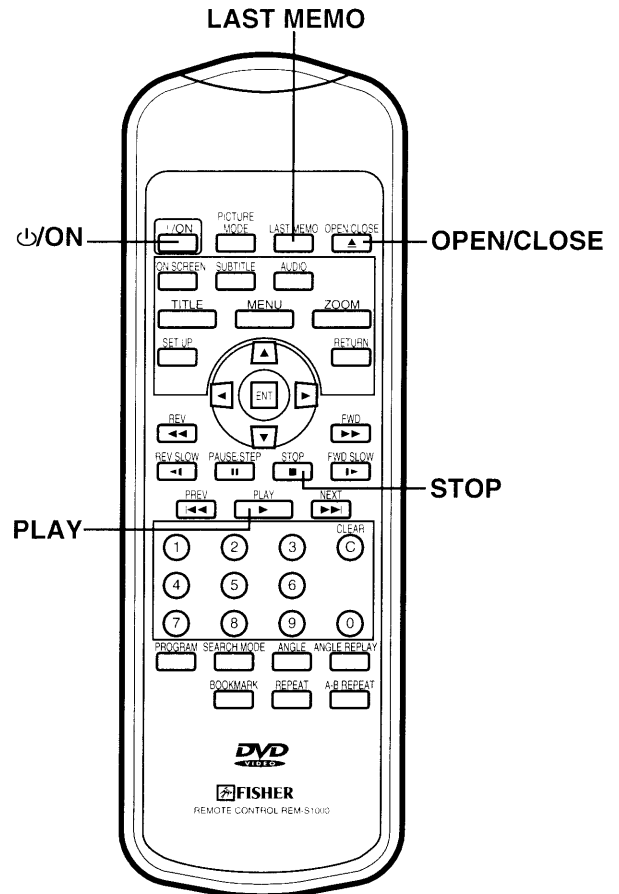

Chapter (Track) Skip Forward/Skip Back

Skipping forward

Press [NEXT] (or [▶▶]) during play to skip to the next chapter (or track).

“Search” appears on the screen.

A chapter (or track) is skipped each time the button is pressed.

Skipping back

Press [PREV] (or [◀◀]) during play to skip back to the beginning of the chapter (or track) currently play.

“Search” appears on the screen.

Press the button again immediately to skip back to the beginning of the previous chapter (or track).

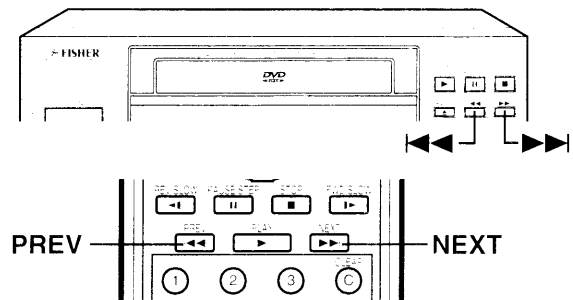
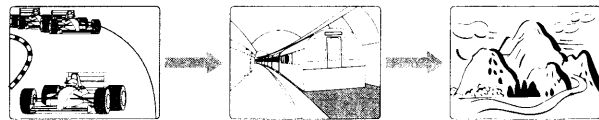

Title/Chapter (Track) Search

1. Press [SEARCH MODE] once during playback or in the stop mode.
“TITLE/CHAPTER SEARCH” or “TRACK SEARCH” screen appears.

2. Press the number buttons to enter the title (or track) number.

3. Press [▼].

4. Press the number buttons to enter the chapter number.
(For Video CD and Music CD, skip this step.)

Notes:

- If you made a mistake, press [CLEAR].
- If you want to exit the “TITLE/CHAPTER SEARCH” or “TRACK SEARCH” screen, press [SEARCH MODE] twice.

5. Press [ENT].

The selected title and chapter (or track) playback starts.

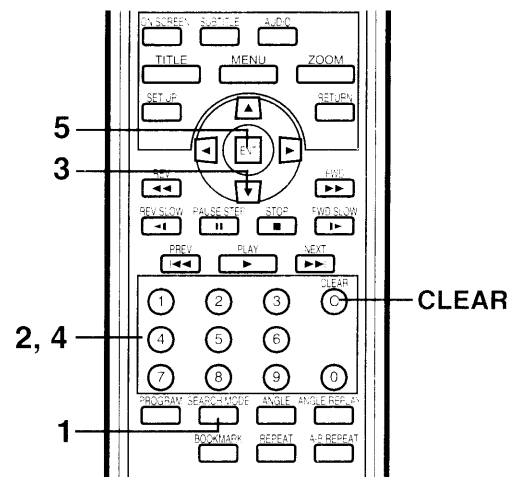

Time Search

1. Press [SEARCH MODE] twice during playback or in the stop mode.
“TIME SEARCH” screen appears.

2. Press the number buttons to enter the time.

Example:

20 minutes 5 seconds Press [2], [0], [0] and [5].

42 minutes 39 seconds Press [4], [2], [3] and [9].

1 hour 4 minutes 35 seconds Press [1], [0], [4], [3] and [5].

Notes:

- If you made a mistake, press [CLEAR].
- If you want to exit the “TIME SEARCH” screen, press [SEARCH MODE].

3. Press [ENT].

Playback starts from the searched time.

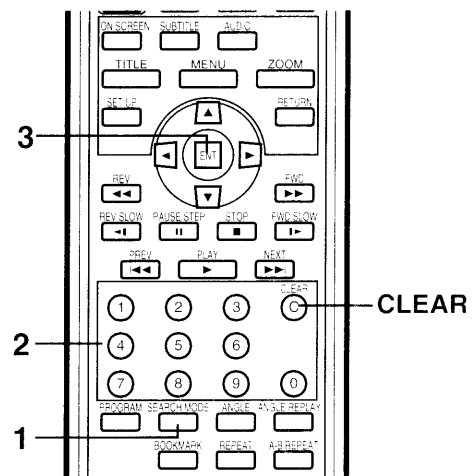

Important Note:

“⊘” may appear on the TV screen during operation. This icon means that the function is not available on the disc now.

Fast Playback

Fast forward playback

Press [FWD] repeatedly to select the fast speed forward playback.

3 steps for DVD/Video CD: "FF1", "FF2" and "FF3"

2 steps for Music CD: "FF1" and "FF2"

Press [PLAY] to return to normal playback.

Fast reverse playback

Press [REV] repeatedly to select the fast speed reverse playback.

3 steps for DVD/Video CD: "FR1", "FR2" and "FR3"

2 steps for Music CD: "FR1" and "FR2"

Press [PLAY] to return to normal playback.

Note:

The sound is muted during fast playback.

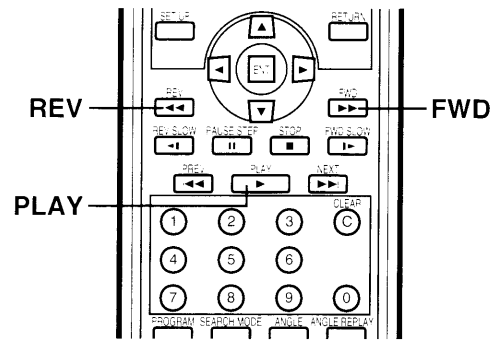

Slow Motion Playback

Forward slow playback [DVD], [Video CD]

Press [FWD SLOW] repeatedly to select the forward slow speed playback (3 steps: "SF1", "SF2" and "SF3").

Press [PLAY] to return to normal playback.

Reverse slow playback [DVD]

Press [REV SLOW] repeatedly to select the reverse slow speed playback (3 steps: "SR1", "SR2" and "SR3").

Press [PLAY] to return to normal playback.

Note:

The sound is muted during slow-motion playback.

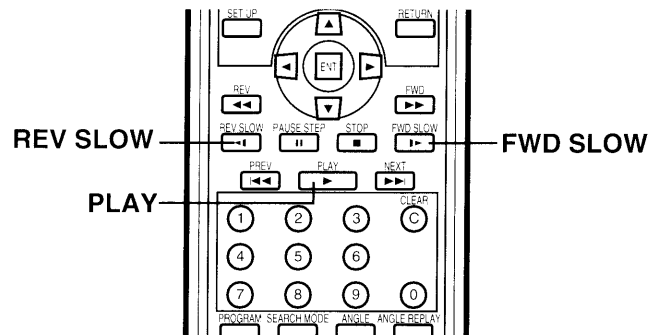

Important Note:

"⊘" may appear on the TV screen during operation. This icon means that the function is not available on the disc now.

Still Picture (Pause)

Press [PAUSE/STEP] during playback.

- "II" appears and the PLAY indicator blinks.
- "Pause II" appears on the TV screen.

Press [PLAY] to return to normal playback.

[DVD], [Video CD]

Still picture mode

[CD]

Pause mode

Note: The sound is muted.

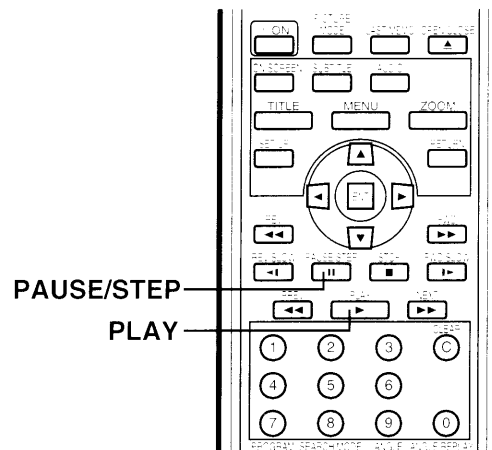

Frame by Frame Advance Playback

[DVD], [Video CD]

Press [PAUSE/STEP] during still playback.

- "Step II▶" appears on the screen.
- Each time the button is pressed, the picture advances one frame.
Press [PLAY] to return to normal playback.

Notes:

- The sound is muted.
- Frame playback is operated forward only.

Zoom Feature [DVD]

1. Press [ZOOM] during normal playback or still playback.
The player magnifies the image (2 times) in the center of the picture.
2. Press [▲], [▼], [◀] or [▶] to change the zoom point.
3. To return to normal playback or still playback, press [ZOOM] again.

Note:

Some discs may not work Zoom feature.

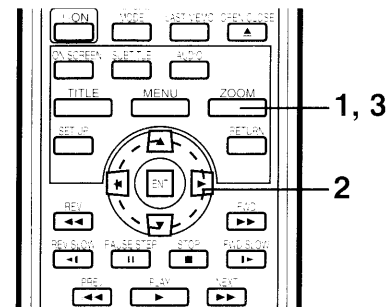
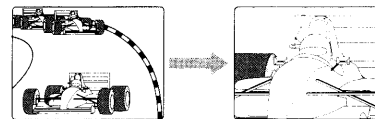

Viewing from a Desired Camera Angle (Multi-Angle)

Some DVD video discs may contain scenes which have been shot simultaneously from a number of different camera angles. The jacket or case of discs that are recorded with angles will be marked.

Example:



Note:

The recorded angles differ depending on the disc used.

1. Play the disc that is recorded with angles.
2. Press [ANGLE] repeatedly until the desired angle appears.

Example:

Angle
03

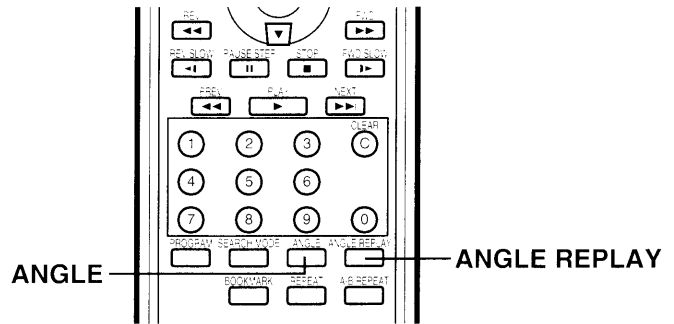
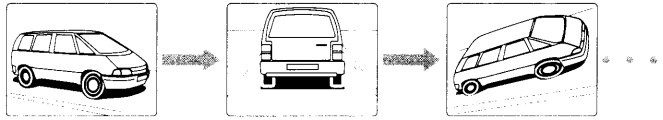

Angle Replay

During Multi-angle playback screen, press [ANGLE REPLAY]. The player skips back to last approximately 10 seconds, changes it to the next camera angle and plays it, and continues playback. If desired, press the button again.

Normal Repeat Play

Press [REPEAT] during playback (or programmed play) of the title or chapter (or track) you want to repeat.

Each time the button is pressed, the repeat mode will be changed as follows.

[DVD]

All Repeat: Repeat all titles

Title Repeat: Repeat of title being played

Chapter Repeat: Repeat of chapter being played

(Program Repeat: Repeat programmed play)

Clear: Normal play mode

[Video CD], [CD]

All Repeat: Repeat all tracks

Repeat 1: Repeat of track being played

(Program Repeat: Repeat programmed play)

Clear: Normal play mode

Note:

When "All Repeat" appears on the TV screen, "REPEAT ALL" appears on the display. But, "REPEAT 1" appears on the display in all other repeat modes.

Designated Range Repeat Play (A-B Repeat)

1. Press [A-B REPEAT] during playback at the beginning of the section you want to repeat (Point A).
 - "Repeat A-" briefly appears on the screen.
 - "REPEAT A-B" blinks on the display.

2. Press [A-B REPEAT] during playback at the end of the section you want to repeat (Point B).
 - "Repeat A-B" briefly appears on the screen.
 - "REPEAT A-B" remains lit.

The section between points A and B is played repeatedly.

Note:

For Video CD, wait 2 seconds at least before pressing the button.

3. To return to normal play, press [A-B REPEAT] again.
 - "Clear" briefly appears on the screen.

Note:

Normal repeat play or A-B repeat play mode may not work correctly with some discs.

Return button (RETURN) for Video CD

Normally, it returns to the previous menu during playback when [RETURN] is pressed.

Note:

The operation differs according to the content of the Video CD.

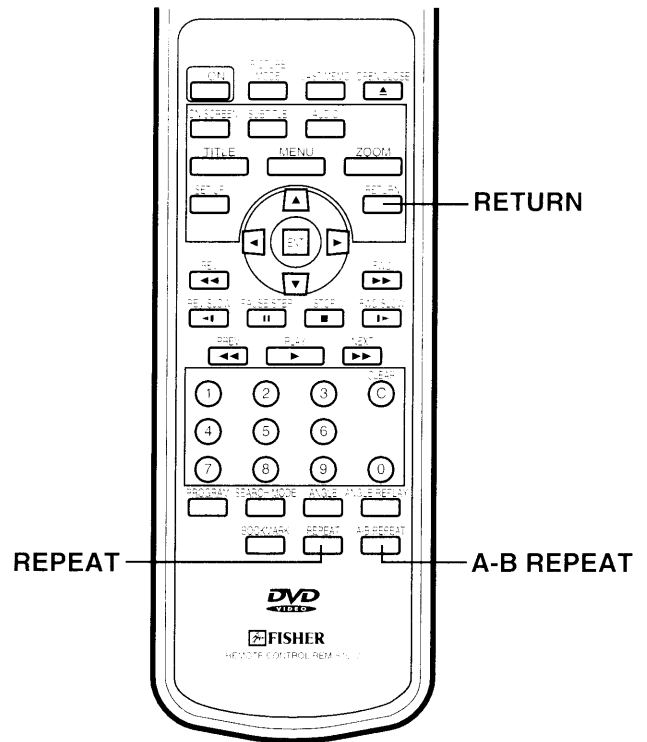

Programmed Play

Up to 32 selections can be programmed.

Programming procedure

1. Press [PROGRAM] during playback or stop mode.
 - "PROGRAM" screen appears.
 - "PROGRAM" blinks and "Pr 1" appears on the display.
2. Press [▲], [▼], [◀] or [▶] to select the title, chapter or track.
3. Press [ENT].
4. Repeat steps 2-3 above to select another title, chapter or track.

Example:

ALL CLEAR		TITLE	CHAPTER
No. :	T, C	-	ALL
1 :	2, 9	1	1
2 :		2	2
3 :		3	3
4 :		4	4
5 :			5
6 :			6
7 :			7
8 :			8
9 :			9
10 :			

Program number

Notes:

- If you made a mistake, press "CLEAR".
- If you want to exit the "PROGRAM" screen, press [PROGRAM].

5. Press [PLAY] to start play.
 - "PROGRAM" remains lit.

When all programmed selections have played, the player stops automatically.

- The program contents are retained in memory.

To clear the program one by one

1. Press [▲], [▼], [◀] or [▶] to select the program number.
2. Press [CLEAR].

To clear all the programs

1. Press [▲], [▼], [◀] or [▶] to select "ALL CLEAR".
2. Press [ENT].

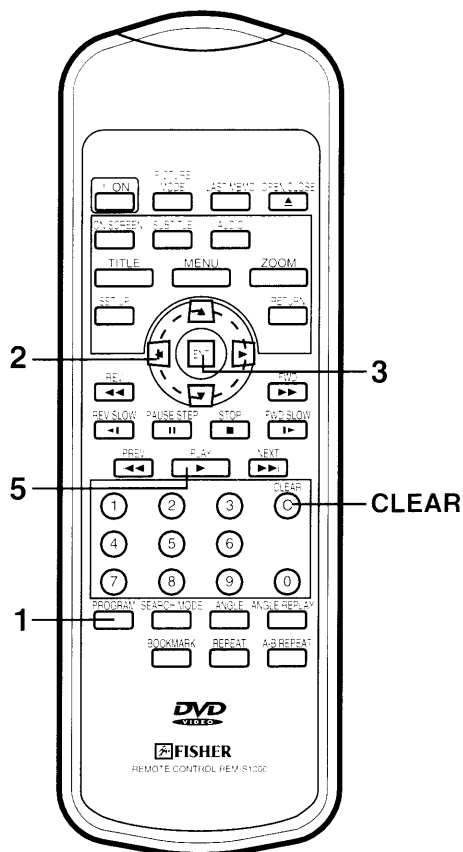

Storing Bookmarks in Memory to be Viewed (listened to) Again

Storing a BOOKMARK in the player's memory is similar to marking your page in a book. You can quickly return to any point on the disc.

Note:

Some discs may not work Bookmark function.

Storing a bookmark in the memory

Up to 5 points can be memorized for each 5 discs.

1. Press [BOOKMARK] during playback.
"BOOKMARK" screen appears.

Example:

No: T, C

- 1: NONE
- 2: NONE
- 3: NONE
- 4: NONE
- 5: NONE

2. Press [▲] or [▼] to select the bookmark number.
3. Press [ENT] at the starting point to be viewed (listened to) again.

Example:

No: T, C

- 1: ENTRY 1, 6
- 2: NONE
- 3: NONE
- 4: NONE
- 5: NONE

Notes:

- If you made a mistake, press "CLEAR".
- If you want to exit the "BOOKMARK" screen, press [BOOKMARK].

Recalling a bookmark

1. Press [BOOKMARK] during playback.
2. Press [▲] or [▼] to select the bookmark number to be recalled.
3. Press [PLAY].
Playback resumes from the point corresponding to the selected bookmark.

Clearing a bookmark

1. Press [BOOKMARK].
2. Press [▲] or [▼] to select the bookmark number to be cleared.
3. Press [CLEAR].

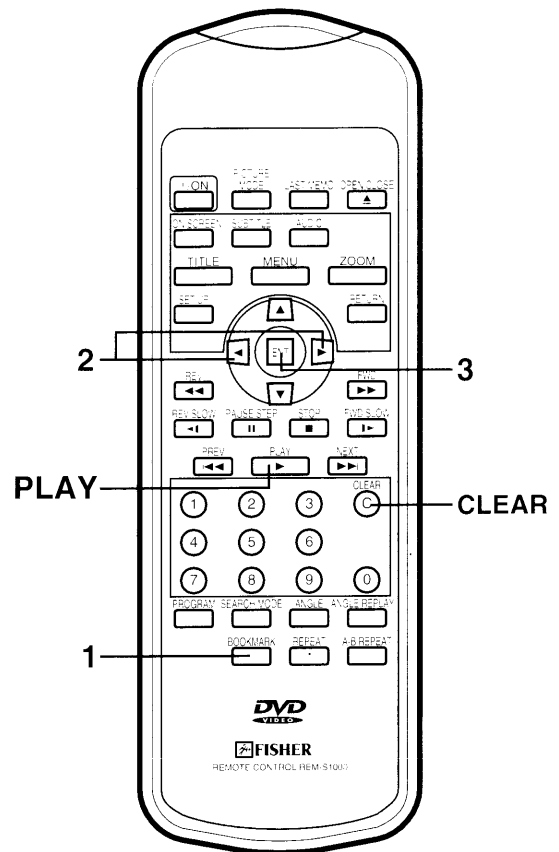

Selecting a Title Menu

Notes:

- The operation may differ depending on the disc used.
- Selecting a title may not be possible on some discs.

1. Press [TITLE].
A list of the titles on the disc will be appeared.

Note:

Press [TITLE] again to resume play from the scene when [TITLE] was first pressed.

2. Press [▲], [▼], [◀] or [▶] (or the number buttons) to select the desired title.
3. Press [ENT].
The selected title playback starts.

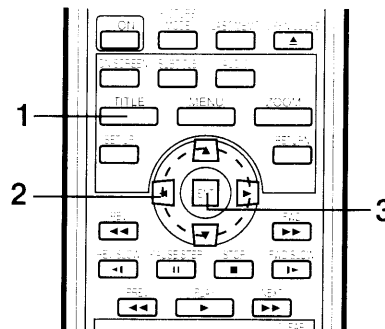

Selecting a DVD Menu

Notes:

- The operation may differ depending on the disc used.
- Selecting a menu may not be possible on some discs.

1. Press [MENU].
The main menu screen will be appeared.

Note: Press [MENU] again to resume play.

2. Press [▲], [▼], [◀] or [▶] (or the number buttons) to select the desired menu.
3. Press [ENT].
The selected menu playback starts.

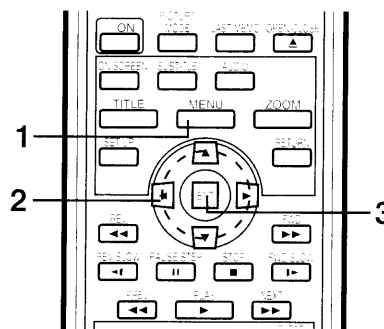

Selecting Subtitle Language

This operation works only with discs on which multiple subtitle languages are recorded.

1. Press [SUBTITLE] during playback.
"SUBTITLE MODE" screen appears.
2. Press [▲], [▼], [◀] or [▶] to select the desired subtitle language.
3. Press [ENT].

Notes:

- In some cases, the subtitle language is not changed to the selected one.
- When a disc supporting the closed caption is played, the subtitle and the closed caption may overlap each other on the TV screen. In this case, turn the subtitle off.
- When the desired language is not selected even if the button is pressed, the language is not available on the disc.
- When the power is turned on or the player is stopped completely or the disc is replaced, select the subtitle language again.
- If "OTHERS" is selected, enter the language code. (See "LANGUAGE CODE LIST" on page E27.)
- If the subtitle language is not necessary, select "NO".

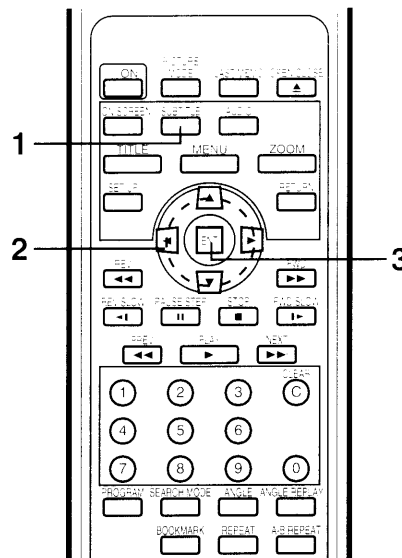

Selecting Audio Soundtrack Language (Multi-Language)

This operation works only with discs on which multiple audio soundtrack languages are recorded.

1. Press [AUDIO] during play.
2. Press [AUDIO] repeatedly until the desired language appears on the screen.

Example:

Language Change
02 French

Notes:

- When the desired language is not selected even if the button is pressed, the language is not available on the disc.
- When the power is turned on or the player is stopped completely or the disc is replaced, select the language again.
- If the language is not recorded on the disc, only the available language on the disc will be heard.
- If "OTHERS" is selected, enter the language code. (See "LANGUAGE CODE LIST" on page E27.)

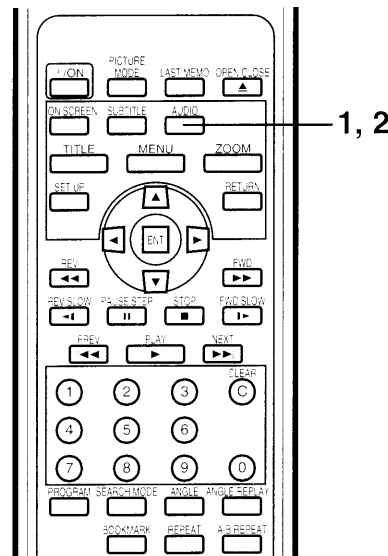

Selecting Picture Mode

Press [PICTURE MODE]. "PICTURE MODE" briefly appears.
Each time the button is pressed, the picture mode is changed as shown:

PICTURE MODE

Cinema → Animation → Sports → Black and White →
Standard → Cinema → ...

Selecting Display Mode

Press [ON SCREEN] to show the disc information (Title, Chapter, Title pass time, Language, etc.).

Example:

DVD		Play ▶
TITLE: 01	Title pass time	00:05:45
CHAPTER: 04	Chapter pass time	00:00:51
AUDIO: English		
Dolby Digital 5.1ch		
SUBTITLE: English		
ANGLE: 1		

DVD		Play ▶
TITLE: 01	Title remain time	00:56:07
CHAPTER: 14	Chapter remain time	00:00:37
AUDIO: English		
Dolby Digital 5.1ch		
SUBTITLE: Others		
ANGLE: 1		

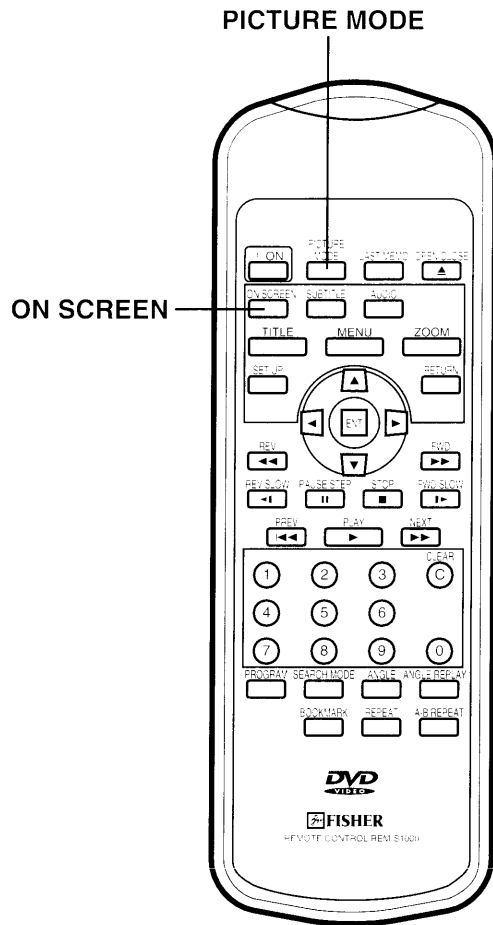

INITIAL SETTINGS

Once the initial settings have been completed, the player can always be operated under the same conditions. The settings will be retained in the memory until they are changed, even if the power is turned off.

Common procedures of initial settings

1. Press [SET UP] in the stop mode.
"SET UP MENU (LANGUAGE, DISPLAY, AUDIO and PARENTAL)" screen appears on the TV screen.
2. Press [▲], [▼], [◀] or [▶], then press [ENT] to select the menu. Please follow these on the screen.
3. Press [SET UP].

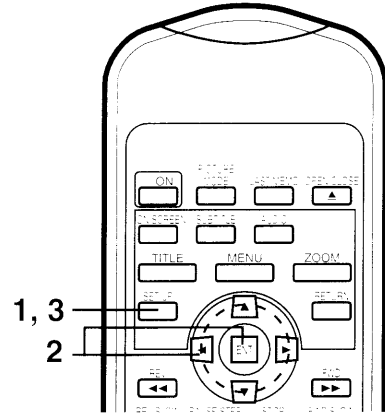

Example:

LANGUAGE OSD: ENGLISH ENGLISH
(Note: The language on OSD is "ENGLISH" only.)

AUDIO: ENGLISH ORIGINAL
 ENGLISH
 JAPANESE
 CHINESE
 GERMAN
 FRENCH
 ITALIAN
 SPANISH
 DUTCH
 OTHERS

SUBTITLE: ENGLISH ORIGINAL
 ENGLISH
 JAPANESE
 CHINESE
 GERMAN
 FRENCH
 ITALIAN
 SPANISH
 DUTCH
 OTHERS

DVD MENU: ORIGINAL ORIGINAL
 ENGLISH
 JAPANESE
 CHINESE
 GERMAN
 FRENCH
 ITALIAN
 SPANISH
 DUTCH
 OTHERS

Notes:

- You cannot switch audio sound track languages if there is only one language recorded on the disc.
- When you play back a DVD video disc, the player automatically displays the pre-selected subtitle language if it is included on the disc.
- If "OTHERS" is selected, enter the language code. (See "LANGUAGE CODE LIST" on page E27.)

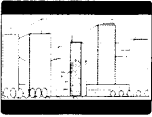
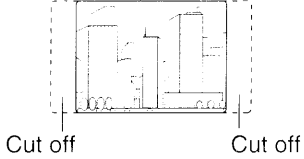
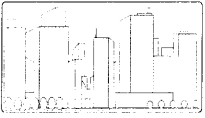

DISPLAY	TV TYPE:	4:3 LT	4:3 LT 4:3 PS 16:9	Select the appropriate your TV screen size.
	SCREEN SAVER:	ON	ON OFF	<p>4:3 LT (Letterbox): Select when a conventional TV set is connected. When the wide screen disc is played back, the black bands appear at the top and bottom of screen.</p> 
	LastMemo Play:	ON	ON OFF	<p>4:3 PS (Panscan): Select when a conventional TV set is connected. When the wide screen disc is played back, it displays pictures cropped to fill to your TV screen. The left and right edges are cut off.</p> 
				<p>16:9 : Select when a wide screen TV set is connected. Played in "FULL" size. (Setting the wide screen TV to "FULL" mode is also necessary.)</p> 
<p>Note: The screen size may differ depending on the DVD video discs.</p>				
AUDIO	DIGITAL OUT:	ON	ON OFF	Select "ON" or "OFF" to send out the Optical digital signal via the DIGITAL OUT jack.
	DOLBY DIGITAL:	2ch	2ch 5.1ch	Select DOLBY DIGITAL "2ch" or "5.1ch".
	MPEG:	PCM	MPEG PCM	Select PCM or MPEG signal.
	DTS:	OFF	ON OFF	<p>Select DTS signal "ON" or "OFF".</p> <p>Note: When using a Digital Amplifier without a DTS decoder, set DTS to "OFF".</p>

LANGUAGE CODE LIST

Enter the appropriate code number for the initial settings "AUDIO", "SUBTITLE" and "DVD MENU".

Code	Language	Code	Language	Code	Language	Code	Language
6565	Afar	7079	Faroese	7678	Lingala	8375	Slovak
6566	Abkhazian	7082	French	7679	Laothian	8376	Slovenian
6570	Afrikaans	7089	Frisian	7684	Lithuanian	8377	Samoan
6577	Amharic	7165	Irish	7686	Latvian, Lettish	8378	Shona
6582	Arabic	7168	Scottish Gaelic	7771	Malagasy	8379	Somali
6583	Assamese	7176	Galician	7773	Maori	8381	Albanian
6588	Aymara	7178	Guarani	7775	Macedonian	8382	Serbian
6590	Azerbaijani	7185	Gujarati	7776	Malayalam	8385	Sundanese
6665	Bashkir	7265	Hausa	7778	Mongolian	8386	Swedish
6669	Byelorussian	7273	Hindi	7779	Moldavian	8387	Swahili
6671	Bulgarian	7282	Croatian	7782	Marathi	8465	Tamil
6672	Bihari	7285	Hungarian	7783	Malay	8469	Telugu
6678	Bengali; Bangla	7289	Armenian	7784	Maltese	8471	Tajik
6679	Tibetan	7365	Interlingua	7789	Burmese	8472	Thai
6682	Breton	7378	Indonesian	7865	Nauru	8473	Tigrinya
6765	Catalan	7383	Icelandic	7869	Nepali	8475	Turkmen
6779	Corsican	7384	Italian	7876	Dutch	8476	Tagalog
6783	Czech	7387	Hebrew	7879	Norwegian	8479	Tonga
6789	Welsh	7465	Japanese	7982	Oriya	8482	Turkish
6865	Danish	7473	Yiddish	8065	Punjabi	8484	Tatar
6869	German	7487	Javanese	8076	Polish	8487	Twi
6890	Bhutani	7565	Georgian	8083	Pashto, Pushto	8575	Ukrainian
6976	Greek	7575	Kazakh	8084	Portuguese	8582	Urdu
6978	English	7576	Greenlandic	8185	Quechua	8590	Uzbek
6979	Esperanto	7577	Cambodian	8277	Rhaeto-Romance	8673	Vietnamese
6983	Spanish	7578	Kannada	8279	Romanian	8679	Volapük
6984	Estonian	7579	Korean	8285	Russian	8779	Wolof
6985	Basque	7583	Kashmiri	8365	Sanskrit	8872	Xhosa
7065	Persian	7585	Kurdish	8368	Sindhi	8979	Yoruba
7073	Finnish	7589	Kirghiz	8372	Serbo-Croatian	9072	Chinese
7074	Fiji	7665	Latin	8373	Singhalese	9085	Zulu

TROUBLESHOOTING GUIDE

If you have followed the instructions and are having difficulty operation the unit. locate the SYMPTOM in the left column below. Check the corresponding POSSIBLE CAUSE and CORRECTIVE ACTION columns to locate and remedy the problem.

SYMPTOM	POSSIBLE CAUSE	CORRECTIVE ACTION
No power.	No power plug connection at the AC wall outlet.	Insert the power plug into the AC wall outlet.
The power is on, but the player does not work.	No disc is loaded.	Load a disc.
No picture.	An unplayable disc is loaded.	Load a playable disc. (Check the disc logo, type, color system and Regional code.)
	The TV is not set to receive signal from the player.	Select the correct input function on the TV.
	The video cable is not connected.	Connect the video cable into the jack.
	The S-video cable is not connected.	Connect the video cable into the jack.
No sound.	The TV is turned off.	Turn on the TV.
	The audio cables are not connected.	Connect the audio cables into the jacks
	The audio equipment is turned off.	Turn on the audio equipment connected with the audio cable.
The playback picture is poor.	An unplayable disc is loaded.	Load a playable disc. (Check the disc logo, type, color system and Regional code.)
"⊘" appears on the TV screen.	The selected function does not operate on the disc now.	Wait or Press the correct button.
The player does not start playback.	No disc is loaded.	Load a disc.
	An unplayable disc is loaded.	Load a playable disc. (Check the disc logo, type, color system and Regional code.)
	The disc is loaded with the label side down.	Load the disc on the disc tray correctly.
	The disc is dirty.	Clean the disc or replace it.
	"PARENTAL" is set.	Cancel the parental lock function or change the rating level. Reset it after play.
The operation or display is not normal.	The player must be reset.	<ol style="list-style-type: none"> 1. Disconnect the power cord. 2. Reconnect the power cord. 3. Resume operation.
The remote control does not work properly.	The batteries in the remote control are weak, or installed incorrectly.	Check the battery polarity (+ or -). Replace the batteries.
	The remote control is not aimed at the remote sensor window.	Aim the remote control at the remote sensor window.

SERVICING:

Should this product require service, refer to the FISHER audio limited warranty.

If you do not have a convenient FISHER service station nearby, contact the FISHER dealer where you purchased the unit. Be sure to give the model number and explain the problem. The dealer will advise you how to obtain service.



MAINTENANCE

WARNING:

FOR YOUR PERSONAL SAFETY, BE SURE TO DISCONNECT THE AC POWER CORD BEFORE PROCEEDING WITH ANY MAINTENANCE OR CLEANING.

Cleaning the cabinet

Use a clean soft cloth moistened with plain lukewarm water and wrung dry. Never use benzol, benzene or other strong chemical cleaners since these could damage the finish of your unit. It is important that no liquid reaches the inside of the unit.

SPECIFICATIONS

Type:

DVD Video player

Signal format:

NTSC color

Laser:

Semiconductor laser, wavelength 650 nm

Frequency range (digital audio):

4 Hz to 44 kHz (DVD fs: 96 kHz)

Signal to noise ratio:

More than 105 dB

Harmonic distortion (digital audio):

0.003 %

Wow and flutter:

Below measurable level

Outputs:

DIGITAL OUT:

Optical

COMPONENT VIDEO OUT:

Y: 1.0 V_{p-p} (75 Ω)

C_B, C_R: 0.7 V_{p-p} (75 Ω)

S-VIDEO OUT:

Y: 1.0 V_{p-p} (75 Ω)

C: 0.286 V_{p-p} (75 Ω)

VIDEO OUT:

1.0 V_{p-p} (75 Ω)

AUDIO OUT:

1.2 V rms

Power requirements:

AC 120 V, 60 Hz

Power consumption:

14 Watts

Dimensions (W x H x D):

Approx. 10.6" x 3.4" x 11.1" (270 x 87 x 282 mm)

Weight:

Approx. 5.3lbs (2.4kg)

IMPORTANT INFORMATION

Because its products are subject to continuous improvement, FISHER reserves the right to modify product designs and specifications without notice and without incurring any obligation.

**FISHER AUDIO
MODEL DVD-S1000 LIMITED WARRANTY**

OBLIGATIONS

In order to obtain warranty service, the product must be delivered to and picked up from an Authorized Fisher Factory Service Center at the user's expense, unless specifically stated otherwise in this warranty. The names and addresses of Authorized Fisher Service Centers may be obtained by calling the toll-free number listed below.

For product operation, authorized service center referral, service assistance or problem resolution, call

**CUSTOMER INFORMATION 1-800-421-5013
Weekdays 8:00 AM - 5:00 PM Pacific Time**

For accessories and/or parts not available from an authorized dealer, call

**PARTS ORDER INFORMATION 1-800-726-9662
Weekdays 8:00 AM - 5:00 PM Pacific Time**

THIS WARRANTY IS VALID ONLY ON FISHER PRODUCTS PURCHASED OR RENTED AND USED IN THE UNITED STATES OF AMERICA. THIS WARRANTY APPLIES ONLY TO THE ORIGINAL RETAIL USER, AND DOES NOT APPLY TO PRODUCTS USED FOR ANY INDUSTRIAL, PROFESSIONAL OR COMMERCIAL PURPOSE. THE ORIGINAL DATED BILL OF SALE, SALES SLIP OR RENTAL AGREEMENT MUST BE SUBMITTED TO THE AUTHORIZED FISHER SERVICE CENTER AT THE TIME WARRANTY SERVICE IS REQUESTED.

Subject to the OBLIGATIONS above and EXCLUSIONS below, SANYO FISHER COMPANY (SFC) warrants this FISHER product against defects in materials and workmanship for the periods of LABOR and PARTS specified below. SFC will repair or replace (at its option) the product and any of its parts which fail to conform to this warranty. The warranty period commences on the date the product was first purchased or rented at retail.

LABOR	PARTS
1 YEAR	1 YEAR

EXCLUSIONS

This warranty does not cover (A) the adjustment of customer-operated controls as explained in the appropriate model's instruction manual, or (B) the repair of any product whose serial number has been altered, defaced or removed.

This warranty shall not apply to the cabinet or cosmetic parts, knobs, batteries or routine maintenance.

This warranty does not apply to uncrating, setup, installation, removal of the product for repair or reinstallation of the product after repair.

This warranty does not apply to repairs or replacements necessitated by any cause beyond the control of SFC including, but not limited to, any malfunction, defect or failure caused by or resulting from unauthorized service or parts, improper maintenance, operation contrary to furnished instructions, shipping or transit accidents, modification or repair by the user, abuse, misuse, neglect, accident, incorrect power line voltage, fire, flood or other Acts of God, or normal wear and tear. The foregoing is in lieu of all other expressed warranties and SFC does not assume or authorize any party to assume for it any other obligation or liability.

THE DURATION OF ANY WARRANTIES WHICH MAY BE IMPLIED BY LAW (INCLUDING THE WARRANTIES OF MERCHANTABILITY AND FITNESS) IS LIMITED TO THE TERM OF THIS WARRANTY. IN NO EVENT SHALL SFC BE LIABLE FOR SPECIAL, INCIDENTAL OR CONSEQUENTIAL DAMAGES ARISING FROM OWNERSHIP OR USE OF THIS PRODUCT, OR FOR ANY DELAY IN THE PERFORMANCE OF ITS OBLIGATIONS UNDER THIS WARRANTY DUE TO CAUSES BEYOND ITS CONTROL.

SOME STATES DO NOT ALLOW LIMITATIONS ON HOW LONG AN IMPLIED WARRANTY LASTS AND/OR DO NOT ALLOW THE EXCLUSION OR LIMITATION OF CONSEQUENTIAL DAMAGES, SO THE ABOVE LIMITATIONS AND EXCLUSIONS MAY NOT APPLY TO YOU.

THIS WARRANTY GIVES YOU SPECIFIC LEGAL RIGHTS. YOU MAY HAVE OTHER RIGHTS, WHICH VARY FROM STATE TO STATE.

F/A R11 (M)

For your protection in the event of theft or loss of this product, please fill in the information below for your own personal records.

Model No. _____

Serial No. _____

(Located on back or bottom side of unit)

Date of Purchase _____

Purchase Price _____

Where Purchased _____



Free Manuals Download Website

<http://myh66.com>

<http://usermanuals.us>

<http://www.somanuals.com>

<http://www.4manuals.cc>

<http://www.manual-lib.com>

<http://www.404manual.com>

<http://www.luxmanual.com>

<http://aubethermostatmanual.com>

Golf course search by state

<http://golfingnear.com>

Email search by domain

<http://emailbydomain.com>

Auto manuals search

<http://auto.somanuals.com>

TV manuals search

<http://tv.somanuals.com>