

SANYO

INSTRUCTION MANUAL

VPC-S5

Digital Camera

Xacti

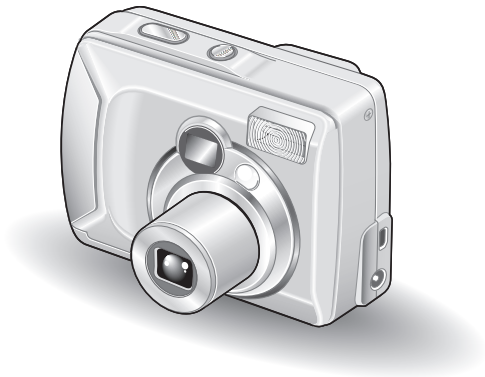

Important note

This manual explains how to safely operate the VPC-S5.

Please read these instructions carefully before using the digital camera. Make sure to read and understand the section "USING YOUR DIGITAL CAMERA SAFELY AND CORRECTLY" on pages 5 to 16. Keep this manual in a safe place for later reference.

Warning

TO PREVENT THE RISK OF FIRE OR ELECTRIC SHOCK, DO NOT EXPOSE THIS APPLIANCE TO RAIN OR MOISTURE

FOR AMERICAN USERS

- This equipment has been tested and found to comply with the limits for a Class B digital device, pursuant to Part 15 of the FCC Rules. These limits are designed to provide reasonable protection against harmful interference in a residential installation. This equipment generates, uses and can radiate radio frequency energy and, if not installed and used in accordance with the instructions, may cause harmful interference to radio communications.

However, there is no guarantee that interference will not occur in a particular installation. If this equipment does cause harmful interference to radio or television reception, which can be determined by turning the equipment off and on, the user is encouraged to try to correct the interference by one or more of the following measures:

- Reorient or relocate the receiving antenna.
 - Increase the separation between the equipment and receiver.
 - Connect the equipment into an outlet on a circuit different from that to which the receiver is connected.
 - Consult the dealer or an experienced radio/TV technician for help.
- Changes or modifications not expressly approved by the party responsible for compliance could void the user's authority to operate the equipment.

Declaration of Conformity

Model number: VPC-S5

Trade Name: SANYO

Responsible party: SANYO FISHER COMPANY

Address: 21605 Plummer Street, Chatsworth, California 91311

Telephone No.: (818) 998-7322

This device complies with Part 15 of the FCC Rules. Operation is subject to the following two conditions:

- (1) this device may not cause harmful interference, and
- (2) this device must accept any interference received, including interference that may cause undesired operation.

FOR CANADIAN USERS

- This Class B digital apparatus complies with Canadian ICES-003.

OUTLINE OF OPERATION

To help you get started enjoying using your digital camera right away, given below is an outline of the fundamental operation, from setup to shooting to playback.

SETUP

① Install the batteries (see page 21).

<When using a card>

- Your camera has a 16MB internal memory that lets you store images even when no SD Memory Card is installed. In addition, images stored in the camera's internal memory can be copied to a card, and vice versa (see page 71).



② Install the SD Memory Card*¹ (see page 22).

③ Format the SD Memory Card (see page 90).

NOTE

- Be sure to format the SD Memory Card with this digital camera before using it. A card that is not formatted using the digital camera may interfere with the operation of your camera.

SHOOTING

① Capture an image.

- Shoot a still image (see pages 29 and 30).
- Shoot a sequential shots series (see pages 29 and 32).
- Shoot a video clip*² (see pages 30 and 33).

PLAYBACK (see page 56)

NOTE

- It is not possible to connect this camera to a TV to view the images.

* 1: About the SD Memory Card

This digital camera can use either an SD Memory Card or a Multi Media Card for data storage. This manual is written with the premise that SD Memory Cards are used. In this manual, SD Memory Card and Multi Media Card are both referred to as "card".

* 2: About video clips

This digital camera does not have audio record or playback functions. Therefore, your recorded video clips will not have sound. Moreover, even if you play back video clips that do have recorded sound with this camera, no sound will be generated.

Symbols used in this manual

- HINT** Points that may prove useful when using the digital camera.
NOTE Points giving some extended instructions or special points to pay attention to.
CAUTION Points that require special attention.
(see page xx) Refer to the page indicated for detailed information.

You may find the answers to questions or problems concerning camera operation in the sections "COMMONLY ASKED QUESTIONS" (see page 112) and "TROUBLESHOOTING" (see page 121).

CONTENTS

OUTLINE OF OPERATION	1
USING YOUR DIGITAL CAMERA SAFELY AND CORRECTLY	5
CHECKING THE INCLUDED ACCESSORIES	17
CAUTIONS CONCERNING THE CARD	18

■ PREPARATION

PARTS NAMES	19
INSTALL THE BATTERIES AND CARD	21
TURNING THE POWER ON/OFF	23

■ SHOOTING

BEFORE TAKING PICTURES (for best results)	25
CAPTURING IMAGES	29
OTHER SHOOTING FUNCTIONS	34
CHANGING THE SHOOTING SETTINGS	40

■ PLAYBACK

VIEWING IMAGES	56
DISPLAYING THE PLAYBACK SETTING SCREEN	61
CHANGING IMAGE SIZE (RESIZE)	63
ROTATING AN IMAGE	65
SLIDESHOW PLAYBACK	66
OTHER PLAYBACK FUNCTIONS	67

■ CAMERA SETTINGS

CHANGING THE CAMERA SETTINGS	81
LCD MONITOR SETTING	83
DATE AND TIME SETTING	85
HELP DISPLAY	88
LANGUAGE	89
INITIALIZING THE CARD MEMORY AND INTERNAL MEMORY	90
POWER SAVE SETTING	92
FILE NO. RESET FUNCTION	94
RESETTING THE CAMERA SETTINGS	96
CHECKING THE REMAINING CARD MEMORY AND INTERNAL MEMORY	97
CHECKING THE REMAINING BATTERY CHARGE	98

■ OTHER FUNCTIONS AND CONNECTIONS

CONNECTING TO A COMPUTER	100
DIRECT-PRINT	103

■ APPENDICES

COMMONLY ASKED QUESTIONS	112
TROUBLESHOOTING	121
SPECIFICATIONS	128
HINTS FOR TAKING PICTURES	135

USING YOUR DIGITAL CAMERA SAFELY AND CORRECTLY

CONCERNING THE DIGITAL CAMERA

WARNING

- **If the digital camera makes a strange noise, emits a strange odor, or if smoke comes out from it, immediately turn off the power and remove the batteries.**

- If the digital camera is used under these conditions, it may cause a fire or electric shock. Immediately turn off the digital camera, remove the batteries, and wait to make sure no more smoke comes from the digital camera. Then take it to the dealer for service. Do not try to repair or open the digital camera yourself.



- **Do not modify or open the cabinet**

- High voltage circuits are inside, and there is a high risk of fire or electric shock if they are touched. Any internal check, setting, or repair should be performed by the dealer.



- **Do not use while driving**

- Do not capture images, play back images, or watch the LCD monitor while driving a vehicle. Doing so may cause an accident.
- Be careful where you put down the digital camera inside an automobile. During sudden stops or turns it may fall behind the brake pedal and prevent braking.



- **Be aware of your surroundings when using the digital camera**

- Pay close attention to your surroundings when using the digital camera. Failure to do so may lead to an accident or injury.
- When using the digital camera while walking, be very careful of your surroundings and especially the traffic to avoid accidents.
- Do not use the digital camera inside an airplane or elsewhere where its use may be restricted.



■ Do not get the digital camera wet

- This digital camera is not water-resistant. Do not allow it to get wet, as doing so may cause a fire or electric shock.
- Do not use the digital camera in a bathroom.
- If the digital camera gets wet, immediately turn it off and remove the batteries. Then take it to a dealer for repair. Using the digital camera after it has become wet may cause a fire, electric shock, or other accident.



■ Do not use during a storm

- To avoid the risk of being struck by lightning, do not use the digital camera during a thunderstorm. In particular, if used in an open field, you have an increased chance of being struck by lightning. Quickly seek refuge in a place that will protect you from lightning.



■ Do not place on an unstable surface

- The digital camera may fall, resulting in damage to the digital camera or injury.
- If the digital camera has fallen and its body is damaged, turn it off, remove the batteries, and take it to the dealer for repair. Using the digital camera after its body has been damaged may cause a fire or electric shock.



■ Do not look through the digital camera into the sun

- Do not look through the digital camera at the sun or any other strong source of light. Doing so may seriously injure your eyes.



■ Do not use the flash close to a person's face

- To prevent possible eye injury, do not use the flash near a person's face (especially young children or babies). If the flash is used close to a person's opened eyes, there is a risk that it may damage that person's eyesight.



USING YOUR DIGITAL CAMERA SAFELY AND CORRECTLY

(CONCERNING THE DIGITAL CAMERA)

WARNING

- **Do not use where there is risk of explosion**
 - Do not use the digital camera in a location where there is explosive gas, or any other flammable material in the air. Doing so may cause a fire or an explosion.
- **Keep the digital camera out of the reach of children**
 - The following may happen if children play with the digital camera:
 - They may wrap the strap around their neck and suffocate.
 - They may swallow the batteries or other small parts. In such a case, consult a physician immediately.
 - They may damage their eyesight if the flash goes off too close to their eyes.
 - They may get hurt by the digital camera.



CAUTION

- **Cautions when carrying the digital camera**
 - Do not walk around holding the digital camera by the handstrap. It may hit other objects and get damaged. When walking around, hold the digital camera in your hand or place it in a pocket.
 - Be careful not to drop the digital camera or subject it to strong shocks.
 - Make sure direct sunlight does not hit the digital camera lens, as that may damage the internal parts. When not using the digital camera, be sure to always turn it off and retract the lens.
- **If the digital camera is not going to be used for a long period of time**
 - For safety's sake, remove the batteries from the camera. This will prevent any possible excess heat or leakage of battery fluid that may result in injuries or damage to nearby objects. (Note that when the batteries is removed for a long period, the time and date settings will be cleared.)

■ Cautions during use and storage

- This digital camera is a precision instrument. When using or storing the digital camera, make sure to avoid the following locations.
 - Places in direct sunlight
 - Places where humidity and temperature are high
 - Places that may get wet
 - Places close to an air conditioner or heater
 - Inside a car
 - Places where there is dust and dirt
 - Places where there is a fire burning
 - Places where volatile products are stored
 - Places subject to vibration



Operating environment

- | | |
|---------------|--|
| • Temperature | 0 to 40°C (operation)
-20 to 60°C (storage) |
| • Humidity | 30 to 90% (operation, no condensation)
10 to 90% (storage, no condensation) |

USING YOUR DIGITAL CAMERA SAFELY AND CORRECTLY

WARNING

Cautions concerning the alkaline batteries

- Follow all the warnings indicated below to prevent the batteries from leaking, overheating, exploding, catching fire, or becoming damaged.
 - Do not install with the polarities ((+) and (-)) inverted.
 - Do not recharge the batteries.
 - Do not heat the batteries or throw them in a fire.
 - Do not allow metal objects to touch the terminals. Do not carry loose with necklaces, hairpins, etc.
 - Do not transform, take apart, or modify the batteries.
 - Do not solder the batteries.
 - Do not allow the batteries to come into contact with fresh or salt water, or allow the terminals to become wet.
 - Do not attempt to remove or puncture the outer casing.
 - Immediately discontinue use if there is leaking, swelling, temperature rising, discoloration, or any other abnormal condition.
 - Keep out of the reach of children.
In the event that a battery is swallowed, seek medical attention right away.
 - Do not drop, hit, or submit the batteries to strong shocks.

General precautions concerning the batteries

- **Use only alkaline batteries or other specified batteries in this camera. Manganese batteries cannot be used, as they have a short battery life and may overheat, causing damage to the digital camera.**
- Never use an alkaline battery together with a Ni-Cd battery, or batteries of different types or different brands at the same time.
- Do not use a new battery together with an old battery, or combine consumed batteries.
- Make sure not to invert the polarity ((+) and (-)) when installing the batteries.
- Use of batteries of different types, new and old batteries, or consumed batteries together may generate heat or cause the batteries to leak, resulting in fire, injury or burns, or damage to the digital camera and any other nearby object.
- When purchasing batteries, be sure to purchase only the specified batteries. Use of batteries without protective casings or other inferior products may cause a fire, injury, or burns.



USING YOUR DIGITAL CAMERA SAFELY AND CORRECTLY

WARNING

- The batteries may be warm immediately after the digital camera is used. If removing the batteries, turn off the digital camera and allow the batteries to cool down before removing them.
- If a battery is leaking and the electrolyte gets on your skin or clothing, immediately rinse with clean water. If the electrolyte gets into your eyes, you risk losing your eyesight. Do not rub your eyes, but immediately rinse your eyes with clean, running water, and seek medical attention right away.
- Do not drop or hit the batteries, or submit them to strong shocks.
- If the digital camera is not going to be used for a long period of time, remove the batteries and store them in a cool place. (When the batteries are removed for a long period, the time and date settings will be cleared.)
- When disposing of the batteries, be sure to follow all applicable regulations.
- Except for the lithium battery (CR-V3), if used in temperatures below 10°C, the service life of the batteries will be shorter than normal.
- If using rechargeable batteries, use after fully recharging with the exclusive battery charger. Always read the instruction manuals that may come with the batteries you purchase before use.



Concerning the accessories

CAUTION

■ Cautions concerning the use of the AC adapter

- Use only the separately sold AC adapter (model VAR-G4AEX for Europe, U.K. and others, and model VAR-G4AU for North America and others) with your digital camera. Do not use an AC adapter other than the one indicated here, designed for specific use with your digital camera.
- If an AC adapter other than the specified one is used, it may damage the digital camera and cause a fire or electric shock.
- Normally when using an AC adapter, remove the batteries. Otherwise the batteries may cause excess heat, leakage, injury or damage to nearby objects.
- For complete information on how to use the AC adapter, refer to the instructions accompanying it.

■ Cautions concerning the card

- Immediately after use, the card will be very hot. Before removing the card, turn off the digital camera and wait for the temperature to cool down.
- Keep out of the reach of children. Young children may put the media in their mouth and choke or cause some other unexpected injury or accident.

USING YOUR DIGITAL CAMERA SAFELY AND CORRECTLY

FOR CORRECT USE OF YOUR CAMERA

■ Cautions before capturing important images

- Before capturing important images, make sure that the digital camera is operating properly and in condition to capture the image properly.
- Sanyo Electric shall not be held responsible for any losses that result from images that could not be recorded, are erased, destroyed, or damaged in any way due to a problem with the digital camera, any of its accessories, or its software.

■ Caution concerning copyrights

- The images you capture with your digital camera are for your own private use; any other use may violate the rights of copyrights owners.
- Please note that photography may be restricted at stage performances, shows or exhibitions, even in presentations whose purpose is entertaining or amusing individuals.
- Also note that images that are intended to be copyrighted cannot be used outside those limits defined by the regulations of the relevant copyright laws.

■ Cautions when cleaning the digital camera

Cleaning procedure

- 1 Turn off the digital camera and remove the batteries.
- 2 Remove the dirt with a soft cloth.
- 3 If the digital camera is extremely dirty, wipe with a soft cloth moistened with a mild detergent diluted with water and wrung dry.

Caution

- Do not use benzene or thinner products to clean the digital camera. Doing so may cause deformation, discoloration, or paint peeling. When using a chemically treated cloth, carefully read its instructions and warnings.
- Do not spray insecticides or volatile sprays on the digital camera. Do not let rubber or vinyl objects contact the digital camera for a long period. They may cause deformation, discoloration, or paint peeling.

■ **Caution concerning the batteries and terminals**

- **Periodically clean the battery terminals ((+) and (-)) as well as the terminals in the camera's battery compartment cover with a dry cloth.** Do not touch the terminals of either the batteries or the battery compartment with your bare hands. Doing so will allow contaminants from your hands to adhere to the terminals and oxidize, increasing the contact resistance. If the contact resistance increases, the usable life of the batteries will diminish.

■ **Caution when cleaning the lens**

- If the lens gets dirty, use a commercially available air blower or a cleaning cloth for photographic equipment to clean it.

■ **When not using the digital camera for a long period**

- Remove the batteries. However, when the batteries are removed for a long time, the digital camera functions may begin to not work properly. Periodically reinstall the batteries and check the digital camera functions.
- If the batteries are left in the digital camera, a small amount of power is still used even if the digital camera is turned off. If the batteries are left in the digital camera for a long period, they may become completely discharged and cannot be used.

■ **Cautions concerning condensation**

- Using the digital camera with condensation inside it may damage the digital camera.

If condensation seems likely to form

- Place the digital camera in a plastic bag and seal it, and then wait until the digital camera has reached the ambient temperature.

Be careful of condensation under the following conditions

- When moving the digital camera suddenly from a cold place to a warm place.
- When the ambient temperature changes drastically, such as when a heater is turned on to quickly heat the room.
- When the digital camera is placed in the path of cool air from an air conditioner.
- When the digital camera is placed in a location of high humidity.

USING YOUR DIGITAL CAMERA SAFELY AND CORRECTLY

FOR CORRECT USE OF YOUR CAMERA (Continued)

■ Caution concerning undesired interference

- The digital camera may create undesired interference if used close to a television or radio. To avoid this type of interference, make sure the cores on the supplied video cable and USB interface cable are not removed.

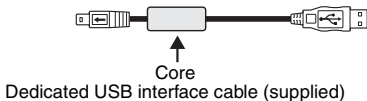

■ Cautions concerning data storage

- It is recommended that any important data be copied onto a separate media (such as a hard disk, MO disk, or CD-R disk).
- Stored data may be lost (or corrupted) in cases such as those listed below. Sanyo Electric will not be held responsible for any damage or lost profits arising from the loss of data.
 - If the card is used incorrectly.
 - If the card is not inserted correctly into the digital camera.
 - If the card is subjected to electrical or mechanical shocks or other forces.
 - If the camera is turned off or a card is inserted/removed while the internal memory or card is being accessed.
 - If the card has reached the end of its usable life.

CAUTION

■ Cautions when handling the cards

- The cards are precision devices. Do not bend, drop, or subject them to strong forces or shocks.
- Avoid using or storing the cards in places with extremely high or low temperatures, subject to direct sunlight, in a completely closed vehicle, near air conditioners or heaters, or in humid or dusty locations.
- Avoid using or storing the cards in locations where strong static electrical charges or electrical noise can be easily generated.
- Do not allow the edges of the cards to become contaminated with foreign materials. Gently wipe away any contamination with a soft, dry cloth.
- Do not carry the cards in trouser pockets, as the cards may become damaged when you sit down or make other movements that may apply forces.
- Before using a new card or a card that was used in other equipment, be sure to format it using the digital camera (see "INITIALIZING THE CARD MEMORY AND INTERNAL MEMORY" on page 90).
- When buying commercially available products, carefully read the instructions and warnings that come with the card.

CHECKING THE INCLUDED ACCESSORIES

- Handstrap

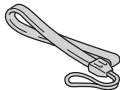

- Software: 1 CD-ROM



- AA alkaline batteries: 2 (batteries specially made to be used as included accessories)

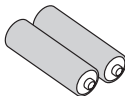

- Dedicated USB interface cable: 1

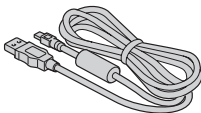

- Quick Guide: 1



Using the included accessories

ATTACHING THE HANDSTRAP



CAUTIONS CONCERNING THE CARD

Media cards that can be used with this digital camera

The types of card that can be inserted into and used with this digital camera are:

- **SD Memory Card**
- **Multi Media Card**

What “card” means in this manual

- In this manual, SD Memory Cards and Multi Media Cards that can be used in this digital camera are referred to as “card”.
- The cards in the illustrations in this manual are SD Memory Cards, but all installation, removal, and formatting procedures are the same for both SD Memory Cards and Multi Media Cards.

PARTS NAMES

Front

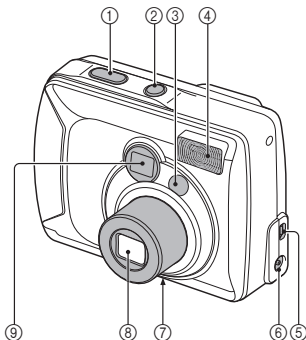

- | | |
|---------------------------------|--|
| ① Shutter release button | ⑤ OUTPUT terminal |
| ② Power button | ⑥ DC IN (external DC power) |
| ③ Mirror | <ul style="list-style-type: none">• For connecting a separately sold AC adapter (model VAR-G4AEX for Europe, U.K. and others, and model VAR-G4AU for North America and others) |
| ④ Flash | ⑦ Tripod stand hole |
| | ⑧ Lens |
| | ⑨ Viewfinder |

Rear

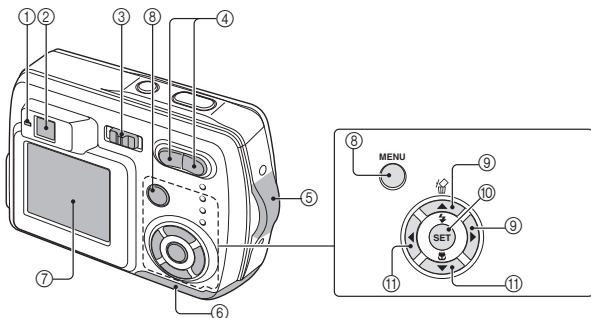

① Accessing indicator: The red LED

Lit:

- Indicates that shooting is enabled; during shooting without using the LCD monitor (see page 83); or during USB connection (see pages 100 and 103).

Flashing (1-second intervals):

When the camera is starting up or when the flash is recharging (shooting not possible); while the manual focus is being set (see page 52); when exposure correction is active (see page 55) or the digital zoom is being used (see page 36) (shooting is possible); During self-timer countdown (see page 37); when the batteries are consumed; or while an image is being saved.

Slow flashing (2-second intervals):

- When the power save mode is active (see page 24); or when the memory is full (shooting not possible).

Rapid flashing (2 flashes per second):

- When an unformatted card (see page 90) or a locked card is installed (shooting not possible); or during self-timer countdown (see page 37)

② Viewfinder

③ Main switch

④ Zoom switch

⑤ Handstrap holder

⑥ Battery compartment cover

⑦ LCD monitor

⑧ MENU button

⑨ [▲] and [▶] arrow buttons

⑩ SET button

⑪ [◀] and [▼] arrow buttons

INSTALL THE BATTERIES AND CARD

Install the batteries

Make sure that the batteries' polarities ((+) and (-)) are correct.

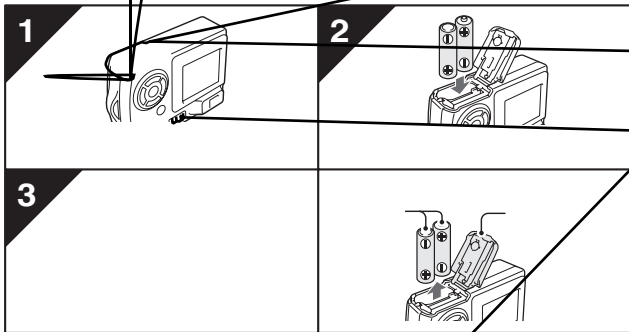

CAUTION

Manganese batteries cannot be used

- Not only do manganese batteries have a short battery life, but there is the danger of their overheating and causing damage to the digital camera.

Other batteries

- If you wish to use batteries other than the alkaline batteries (LR6), we recommend the following.
 - AA-size nickel metal hydride (NiMH) batteries (SANYO HR-3UF) × 2
 - AA-size Ni-Cd batteries (SANYO N-3UV) × 2
 - Lithium battery (CR-V3) × 1

When installing the batteries, make sure that they are oriented correctly.

Do not open the battery compartment cover when the camera is turned on.

- If the battery compartment cover is opened while the power is on, important data may be lost. Sanyo Electric shall not be held responsible for any losses that result from failure to comply with this warning.

Insert the card

The card can be used after it has been formatted with the camera (see page 90). When inserting the card, make sure that it is correctly oriented.

Take special care to orient the card correctly when inserting it. Attempting to insert the card incorrectly may result in damage.

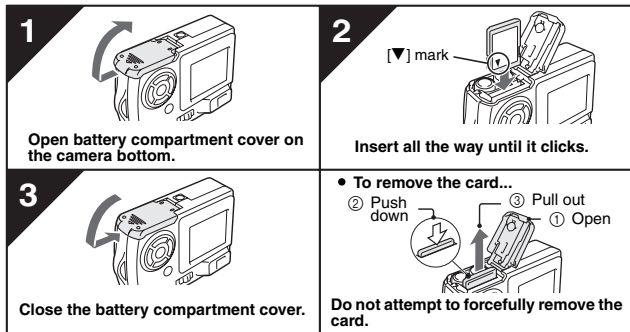

HINT

Shooting without a card

- When a card is installed in your camera, you can photograph images and play them back from the card. When no card is installed, you can still shoot pictures and play them back from the camera's 16 MB internal memory. Also, the internal memory icon  appears on the LCD monitor when the camera is turned on and there is no card installed.

About the internal backup battery

- This camera's internal battery serves to maintain the date and time settings, as well as the shooting settings. The backup battery will be fully charged when the batteries are kept in the camera continuously for about 2 days. In the fully charged state, the backup battery will maintain the camera settings for about 7 days.





When not using the camera for a long time, remove the batteries

- A small amount of power is still used even if the digital camera is turned off, and it is therefore recommended that the batteries be removed from the camera if it is not going to be used for a long time. Note that when the batteries are removed for a long period, the time and date settings may be cleared. Before using your camera again, be sure to confirm that the camera settings are correct.

TURNING THE POWER ON/OFF

Turning the power on

When capturing images

- 1 Set the main switch to [] or [].
[]: To shoot still images or sequential shots
[]: To shoot video clips

- 2 Press the power button.
 - The power turns on, an image appears on the LCD monitor, and the accessing indicator next to the viewfinder lights.

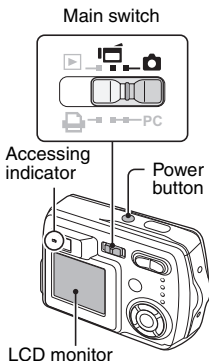

When playing back images

- 1 Set the main switch to [].
- 2 Press the power button.
 - The power turns on, and an image appears on the LCD monitor.

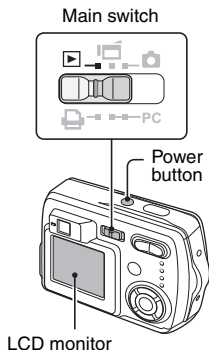

Turning the power off

1 Press the power button.

- The power turns off.
- The LCD monitor and accessing indicator turn off.
- If the lens is extended, it automatically retracts.

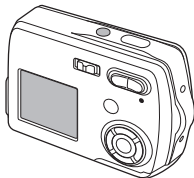

Turning the power on when the power save function is active

In order to save the battery power, the power save function will automatically turn off the power after one minute of no use during shooting, or five minutes of no use during playback (factory-preset setting).

- When the power save function is active, the power is restored after any of the following operations:
 - Press the power button.
 - Press the shutter release button.
 - Press the MENU button.
 - Press the SET button.
- After the power save function has been active for 15 minutes, the power will turn off completely.
- When the separately sold AC adapter (model VAR-G4AEX for Europe, U.K. and others, and model VAR-G4AU for North America and others) is connected, the power save function will become active about 10 minutes after the camera is turned on (factory-preset setting).
- The user can specify the time elapsed before the power save function is activated (see page 92).
- When the camera is connected to a computer or printer using the dedicated USB interface cable, the power save function is disabled, and the camera turns off after about 12 hours.

BEFORE TAKING PICTURES (for best results)

Recording the date and time

When the correct date and time are set in your camera, the date and time are recorded with the image each time you snap a picture (see page 85).

To facilitate organizing your photographed data, it is recommended that you complete your camera's date and time settings before shooting pictures.

A clock alert icon  appearing on the LCD monitor indicates that the date and time settings have not been completed.

Holding the camera

Hold the camera securely with both hands, keeping your elbows close to your body and making sure the camera is stable.

Correct hold



Incorrect hold



A finger is blocking the lens.

Make sure that the lens or flash is not blocked by your fingers or the handstrap.

HINT

- Images captured in the still image shooting mode or sequential shots shooting mode can be rotated when they are played back (see page 65). Note that video clips cannot be rotated while they are being played back.
- When the optical zoom is used or when the autofocus is operating, the image may appear to waver, but this is not a malfunction.

Using the Autofocus

The autofocus will work in almost all situations; however, there are certain conditions that may cause the autofocus function to not work properly. If the autofocus function is not working properly, set the focus range to capture images (see page 52).

■ Conditions that may cause incorrect focus

The following examples are some of the situations where the autofocus function may not work.

- **Subjects with low contrast, very bright subjects at the center of the image, or dark subjects or locations**

Use the focus-lock function (see page 30) to lock the focus on an object with contrast at the same distance as the desired subject.



- **Subjects without vertical lines**

Use the focus-lock function to lock the focus on the subject while holding the digital camera vertically.

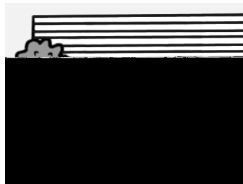

BEFORE TAKING PICTURES (for best results)

The following examples are some of the situations where the autofocus function may work, but not as desired.

- **When both near and far objects are present**

Use the focus-lock function to lock the focus on an object at the same distance as the desired subject, then reposition the

While the image data is being recorded...

- The accessing indicator flashes while an image is being recorded and it is not possible to take another picture at this time. When the accessing indicator stops flashing, the camera is again enabled for shooting.

View the image just captured (preview display)

- Immediately after capturing an image, you can press the SET button to preview the image. Press the [◀] or [▶] arrow button to view the previous image or the next image. For video clips, press the SET button to begin playback, and press the [▲] arrow button to pause playback. Also, when playback is paused, you can press the [◀] or [▶] arrow button for fast forward play or fast reverse play.

After video clip playback has ended, you can go to the start of the previously recorded video clip by pressing the [◀] or [▶] arrow button.

If you do not want to keep the image, you can press the [▲] button at this time to delete the currently displayed image from the camera's memory. To return to the shooting mode, press the [▼] arrow button.

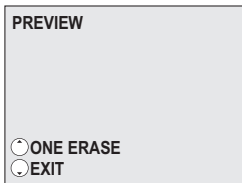

CAPTURING IMAGES

Setting the shooting mode

Set the camera to the still image or sequential shots shooting mode

1 Set the main switch to [], and turn on the camera (see page 23).

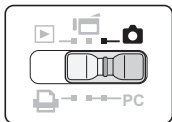

- An image appears on the LCD monitor. If no image appears, please see page 83 and follow the steps to enable the LCD monitor.



2 Press the **MENU** button.

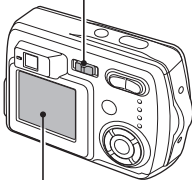

- The Still Image Shooting Setting Screen appears.

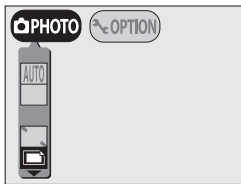

3 Press the [] or [] arrow button to select the operation mode menu.

- : To capture still images (still image shooting mode).
- : To capture sequential shots (sequential shots shooting mode).



4 Press the [] or [] arrow button to select the desired icon, and press the **SET** button.

- If you press the MENU button, the still image shooting setting screen is canceled.

Set the camera to the video clip shooting mode

- 1 Set the main switch to [i], and turn on the camera.
 - An image appears on the LCD monitor. If no image appears, please see page 83 and follow the steps to enable the LCD monitor.

Capturing still images

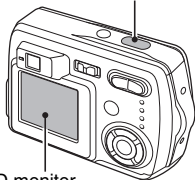

- 1 Set the camera to the still image shooting mode (see page 29).

Shutter release button



LCD monitor

- 2 Slowly press and hold the shutter release button halfway.

- The target mark  or the focus icon  (focus-lock) appears in the LCD monitor.
- If the Shooting Setting Screen (see page 40), was displayed, it is exited.

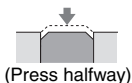

(Press halfway)

Focus icon

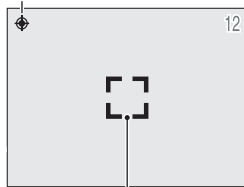

Target mark

- 3 Press the shutter release button all the way.

- The image is captured.

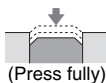

(Press fully)

CAPTURING IMAGES

NOTE

About the focus icon and target mark

- The target mark outlines the area that the camera is using to focus. If the area outlined by the target mark is not the subject you want to focus on, then refocus your subject, for example by changing the shooting angle.
- The target mark does not appear in the following situations.
 - When the subject is not in focus
 - When using the self-timer to take a picture (see page 37)
 - When the focus is set to focus range **MF** or **▲** (see page 52)
 - When the Scene Select **☼** or **☼** function is enabled (see page 45)
- When the camera focuses on a wide area of the central part of the screen, a large target mark appears.

If the motion alert icon appears...

- During still image shooting, if the shutter speed is slow and the possibility that the image may be blurred due to camera movement becomes high, the motion alert icon **⚡** may appear on the LCD monitor. In this case, use a tripod to stabilize the camera when shooting, or set the flash operation mode to automatic (see page 34).
- When shooting with the scene selection function set to the fireworks **☼** mode, the motion alert icon always appears, but this is normal.

Motion alert icon

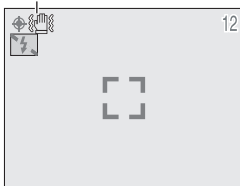

Capturing sequential shots

- 1 Set the camera to the sequential shots shooting mode (see page 29).
- 2 Press the shutter release button to capture the sequential shots.
 - Images are captured as long as the shutter release button is pressed.
 - During shooting, **REC** appears in the LCD monitor.
- 3 Finish capturing images.
 - Release the shutter release button to end recording.

About the maximum number of sequential shots

The maximum number of sequential shots varies depending on the resolution and compression settings.

Resolution setting	10M		5M		2M		WEB	
Compression setting	FINE	NORM	FINE	NORM	FINE	NORM	FINE	NORM
Maximum number of sequential shots	Not available		3	4	4		4	

NOTE

About the focus during sequential shots shooting

- In sequential shots shooting, the autofocus function is activated when the shutter release button is pressed halfway and remains fixed at the same focus until the sequential shots are finished.

CAPTURING IMAGES

Video Clips (no audio)

Your camera can shoot Video clips.

* Video clips can only be shot without sound.

1 Set the camera to the video clip shooting mode (see page 30).

2 Press the shutter release button to record the video clip.

- It is not necessary to keep the shutter release button pressed while shooting.
- During recording **REC** appears on the LCD monitor.
- When the remaining recording time available for the currently recording clip becomes little, a countdown of the remaining recording time appears on the display.

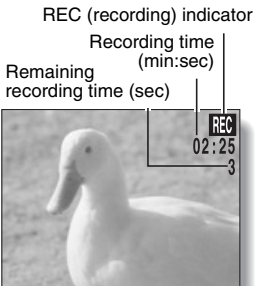

3 End the recording.

- Press the shutter release button to stop recording.
-

NOTE

- The data for a video clip is very large. Therefore, be aware that if the video clip is uploaded to a computer to be played back, the computer may not be able to play back the video fast enough, making it appear jerky. (The video will always be displayed properly on the LCD monitor.)
- The possible shooting time for each video clip will differ depending on the card. Also depending on the card, shooting may end even before the possible shooting time indicated on page 132.

OTHER SHOOTING FUNCTIONS



Using the flash

The flash is used not only for taking pictures where there is insufficient light, but also when the subject is in shade or in backlight conditions. Your camera has four modes of operation (automatic flash mode, forced flash mode, flash off mode, and red-eye reduction mode). The flash is available only when shooting still images.

1 Set the camera to the still image shooting mode (see page 29).

- The current flash mode is shown on the LCD monitor.

No icon: The digital camera will detect the subject brightness and use the flash only when required. In a backlight situation, if only the center of the image is very dark, the flash will operate to compensate (auto flash).

- : The flash will operate with every image captured regardless of the conditions. Use this setting under backlight conditions, when the subject is in shade, under fluorescent lighting conditions, etc. (forced flash).
- : The flash will not operate even in dark situations. Use this setting when capturing an image in a location where flash photography is prohibited, or when shooting a night landscape scene (flash off).
- : The digital camera will detect the subject brightness and use the flash only when required. At this time the flash will operate in a manner that reduces the red reflection ("red-eye") in the subject's eyes.

Flash mode

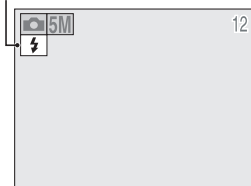

OTHER SHOOTING FUNCTIONS

- 2 Press the flash button [⚡] ([▲]) to select the flash mode.**
- Each time the flash button is pressed, the flash mode icon changes.

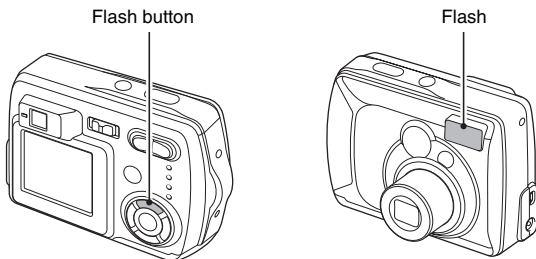

-
- 3 Press the shutter release button.**
- The image is captured in the desired flash mode.
- <Shooting without using the LCD monitor>**
- ① Press the flash button.
 - The LCD monitor turns on briefly to show the currently set flash mode.
 - ② Press the flash button within 5 seconds to set the desired flash mode.

NOTE

In the automatic flash mode...

- In the automatic flash mode using the LCD monitor, when the shutter release button is depressed halfway, a  icon appearing in the upper right area of the LCD monitor indicates that the flash will operate.

Using the zoom

There are two zoom functions: optical zoom and digital zoom.

1 Point the camera lens at the subject.

2 Press [T] or [W] on the zoom switch to compose the desired image.

[T]: Zoom in on the subject.

[W]: Zoom out.

- When the zoom switch is pressed, the zoom bar appears on the LCD monitor.
- When the optical zoom factor is at maximum, zooming stops temporarily. When [T] on the zoom switch is pressed again, the mode changes to the digital zoom mode and zooming continues (if digital zooming is enabled).

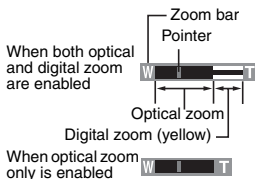
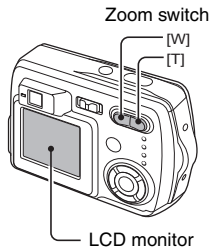

3 Press the shutter release button.

NOTE

- When shooting without the LCD monitor, the digital zoom is not available.
- At the WIDE end, the zoom is resetting; this is not a malfunction.



OTHER SHOOTING FUNCTIONS

SELF-TIMER

The self-timer can be used to take photos in the still image shooting mode and sequential shots shooting mode.

1 Set the camera to the still image or sequential shots shooting mode, press the MENU button and select the self-timer menu.

2 Press the [▲] or [▼] button to select the self-timer menu.

- : Turns off the self-timer function.
- : Turns on the self-timer function. The image is captured about 2 seconds after the shutter release button is pressed.
- : Turns on the self-timer function. The image is captured about 10 seconds after the shutter release button is pressed.

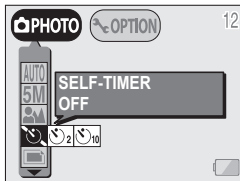

3 Select desired icon, and press the SET button.

- This completes the self-timer setting.

4 Press the shutter release button.

When is selected...

When the shutter release button is pressed, the self-timer indicator flashes for about 7 seconds, then flashes rapidly for about 2 seconds, and then is lit for 1 second to indicate the timing at which the shutter will be released.

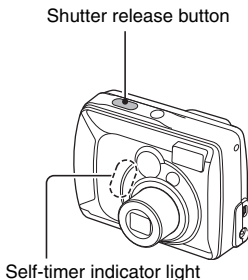

OTHER SHOOTING FUNCTIONS

NOTE



- When using the self-timer function, be sure to use a tripod or place the digital camera on a level, stable surface.

HINT

About the focus

- In self-timer photography, the autofocus is activated just before the shutter is released to produce a focussed image.



To pause or cancel the self-timer function...

- If the shutter release button is pressed again before the image is captured, the self-timer countdown temporarily stops. Press the shutter release button one more time to restart the self-timer.
- To cancel self-timer photography, select the self-timer off icon  and press the SET button.
- The self-timer setting automatically changes to off  after the picture is snapped.

CHANGING THE SHOOTING SETTINGS

You can change the shooting settings by selecting the desired menu from the Shooting Setting Screen and modifying the settings.

Displaying the Shooting Setting Screen

- 1** Set the main switch to [] or [], and turn on the camera (see page 23).

[]: The camera is set to the still image/sequential shooting mode.

[]: The camera is set to the video clip shooting mode.

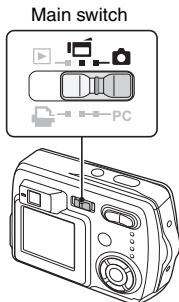

- 2** Press the MENU button.

[]: The Still Image/Sequential Shooting Setting Screen appears (see page 41).

[]: The Video Clip Shooting Setting Screen appears (see page 43).

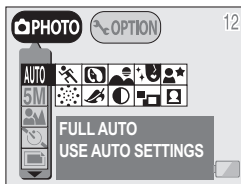

<Still Image/Sequential Shooting Setting Screen>

- **To cancel the Shooting Setting Screen**

- Press the MENU button.

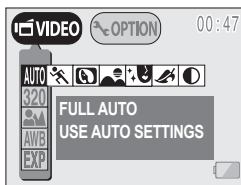

<Video Clip Shooting Setting Screen>

CHANGING THE SHOOTING SETTINGS

Still Image/Sequential Shots Shooting Setting Screens

* All the icons never appear at the same time.

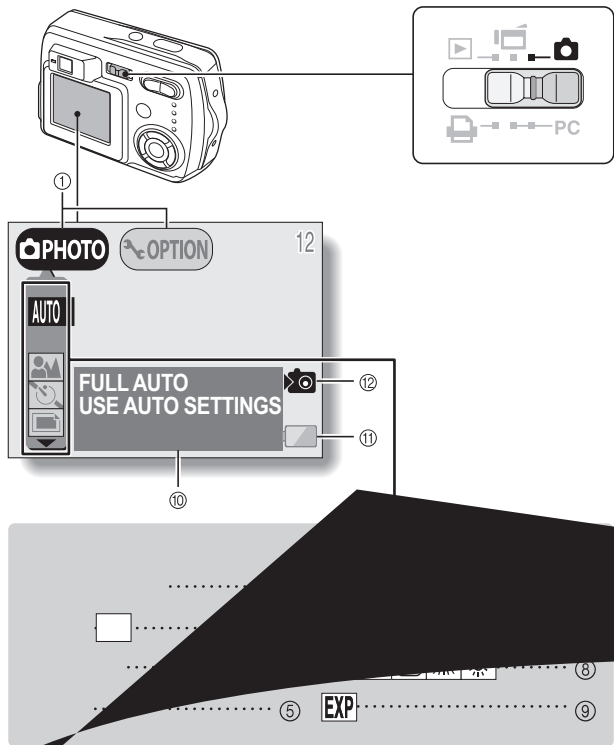

① **Setting/option switch (see page 81)**

Switch between the Shooting Screen and the Option Screen

② **Scene Select menu (see page 45)**

 : Full auto icon

 : Sports icon

 : Portrait icon

 : Landscape icon

 : Cosmetic icon

 : Night view icon

 : Fireworks icon

 : Sepia icon

 : Monochrome icon

 : Composite icon

 : ID photo icon

③ **Resolution menu (see page 50)**

5M : 2,592 × 1,944 pixels (5 million pixels) resolution icon

10M : 3,680 × 2,760 pixels (10 million pixels) resolution icon

 : 1,600 × 1,200 pixels (2 million pixels) resolution icon

 : 640 × 480 pixels (300,000 pixels) resolution icon

④ **Focus menu (see page 52)**

 : Shooting with the autofocus

 : Super macro icon

 : Distance photography

 : Shooting with manual focus

⑤ **Self-timer menu (see page 37)**

⑥ **Mode menu (see page 29)**

⑦ **Compression menu (see page 51)**

⑧ **White Balance menu (see page 54)**

⑨ **Exposure correction icon (see page 55)**

Adjust the image brightness.

⑩ **HELP display (see page 88)**

⑪ **Remaining battery charge (see page 98)**

⑫ **Internal memory icon (see page 22)**

- When two mutually exclusive settings are made, the later setting has priority, and the related settings are changed accordingly.

CHANGING THE SHOOTING SETTINGS

Video Clip Shooting Setting Screen

* All the icons never appear at the same time.

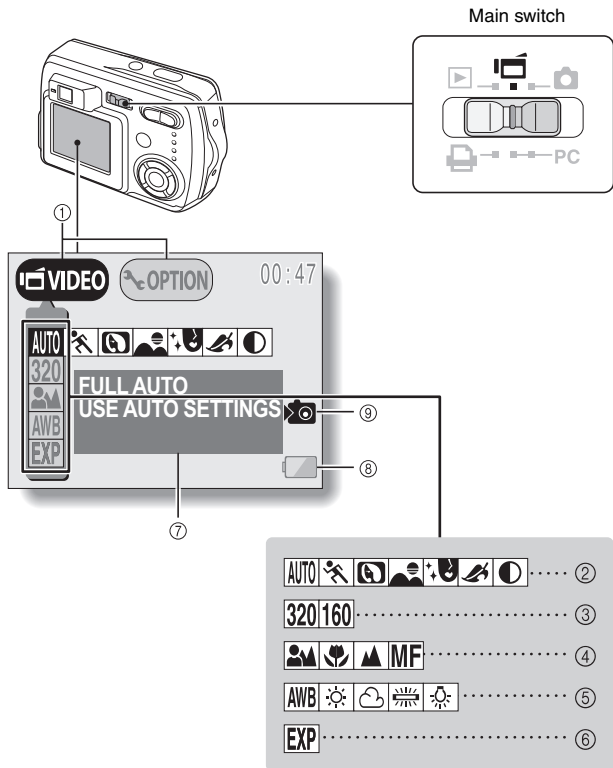

① **Setting/option switch (see page 81)**

Switch between the Shooting Screen and the Option Screen.

② **Scene Select menu (see page 45)**

 **AUTO**: Full auto icon

: Sports icon

: Portrait icon

: Landscape icon

: Cosmetic icon

: Sepia icon

: Monochrome icon

③ **Resolution menu (see page 50)**

 **320**: 320 × 240 pixel resolution icon

 **160**: 160 × 120 pixel resolution icon

④ **Focus menu (see page 52)**

: Shooting with the auto focus

: Super macro icon

: Distance photography

 **MF**: Shooting with manual focus

⑤ **White Balance menu (see page 54)**

 **AWB**: The camera determines the optimum white balance settings based on the ambient light and weather.

: Fair weather setting

: Overcast setting

: Fluorescent lighting setting

: White (incandescent) light setting

⑥ **Exposure correction icon (see page 55)**

Adjust the image brightness.

⑦ **HELP display (see page 88)**

⑧ **Remaining battery charge (see page 98)**











⑨ **Internal memory icon (see page 22)**

- When two mutually exclusive settings are made, the later setting has priority, and the related settings are changed accordingly.

CHANGING THE SHOOTING SETTINGS

Scene Select function

You can select from various preset settings (aperture, shutter speed, special effects, etc.) for specific shooting conditions.

Shooting mode			Features
Still image	Sequential shots	Video clip	
Full auto 			The camera makes settings suitable for the surrounding conditions.
Sports 			Capture a split-second image of a fast-moving subject.
Portrait 			Enhance the 3D feeling of the subject by blurring the background.
Landscape 			For beautiful shots of distant scenery.
Cosmetic 			Enhance skin tones during close-up shots.
Night view 	-	-	Photograph the subject while keeping the background night scenery.
Fireworks 	-	-	For photographing fireworks displays.
Sepia 			Create a sepia-tone photo.
Monochrome 			Snap black-and-white photos.
Composite 	-	-	Select a frame to create a composite photo.
ID photo 	-	-	Creates three identical ID photos in two size (6 total): 45 × 35 mm [1.77" × 1.38"] and 40 × 30 mm [1.57" × 1.18"], printed out on postcard-sized paper.

- 1** Display the Shooting Setting Screen (see page 40), and select the scene select menu.

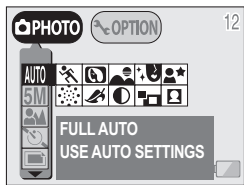

<Example: Still image shooting mode>

- 2** Select the desired icon, and press the SET button.

AUTO : Full auto

 : Sports

 : Portrait

 : Landscape

 : Cosmetic

 : Night view

 : Fireworks

 : Sepia

 : Monochrome

 : Composite

 : ID photo

NOTE









To return to normal shooting

Select **AUTO** from the scene select menu, and press the SET button.

CHANGING THE SHOOTING SETTINGS

Notes regarding the Scene Select feature

Please note the following points when using the Scene Select feature.

Setting	Remarks
Sports 	Manual focus [MF] is available for the focus range setting.
Portrait 	
Landscape 	
Cosmetic 	
Night view 	To prevent taking blurred photos, use a tripod or the like to stabilize the camera.
Fireworks 	To prevent taking blurred photos, use a tripod or the like to stabilize the camera. The flash cannot be used. The focus setting is fixed at the distance photography  setting.
Composite 	The [10M] and [5M] resolution settings are not available. Manual focus [MF] is available for the focus range setting.
ID photo 	The [10M] resolution setting is not available. Manual focus [MF] is available for the focus range setting.

NOTE

When shooting without using the LCD monitor...

- The digital zoom cannot be used.

Shooting composite (combined) images

- 1** Select the composite icon  from the Scene Select menu, and press the SET button.

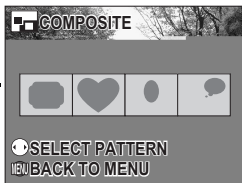

- 2** Press the SET button again.
 - The frame selection display appears.

- 3** Press the [◀] or [▶] button to select the desired frame shape, and press the SET button.
 - The select frame shape fills the display.

- 4** Capture the image for the background (frame).
 - Point the lens at the background subject, and snap the picture.



- 5** Next, capture the image that will be superimposed in the frame.
 - Take the photo of the image inside the frame.



CHANGING THE SHOOTING SETTINGS

Snapping ID photos

Lets you take either of two different-sized ID photos (45 × 35 mm [1.77" × 1.38"] or 40 × 30 mm [1.57" × 1.18"], printed out on postcard-sized paper).

1 Select the ID photo icon  from the Scene Select menu, and press the SET button.

2 Press the MENU button again.

- The ID photo outline appears on the LCD display.

3 Align the subject with the ID photo outline, and snap the picture.

- After the preview screen for the captured image appears, you are returned to the Shooting Screen.
- Three images are shown in each of two sizes on the Playback Screen.



<Playback Screen>

Adjusting the image quality

■ Resolution setting

If the resolution is increased, the image quality will improve, but the number of remaining images that can be taken will decrease. Select the resolution according to the desired image quality and purpose.

- 1 Display the Shooting Setting Screen (see page 40), and select the resolution menu.

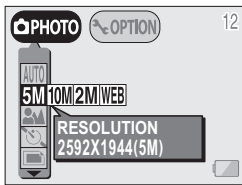

- 2 Select the desired resolution icon, and press the SET button.
<Still image/sequential shots shooting modes>

10M: 10 million pixels (3,680 × 2,760 pixels)

5M: 5 million pixels (2,592 × 1,944 pixels (still image shooting mode only))

2M: 2 million pixels (1,600 × 1,200 pixels)

WEB: 300,000 pixels (640 × 480 pixels)

<Video clip shooting mode>

320: 320 × 240 pixels

160: 160 × 120 pixels

<Example: Still image shooting mode>

HINT

Concerning shooting at **10M** resolution

- At the **10M** resolution, the digital zoom is not available.
- When shooting at **10M** resolution, the camera processes the captured image internally to produce a 3,680 × 2,760 pixels image.

CHANGING THE SHOOTING SETTINGS

■ Set the compression rate (still images and sequential shots only)

Use the procedure below to set the compression rate. Even if the same resolution is used, you can change the compression setting to decrease the image data size so that you can capture more images, or increase the image data size for no loss in image quality.

1 Display the Shooting Setting Screen (see page 40), and select the compression menu.

2 Select the desired compression rate icon, and press the SET button.

[FINE]: Stores the data with a low compression (high quality).

[NORM]: Stores the data with normal compression (normal quality).

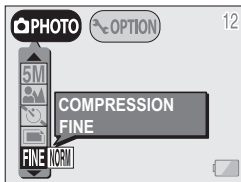

NOTE

About the resolution and compression settings

- The image captured by a digital camera consists of a collection of small dots. The resolution refers to the number of these dots, and the greater the number, the higher the image quality. As the resolution increases, the size of the resulting data also increases, and the number of images that can be captured decreases. To compensate for this, this digital camera is able to compress the data. This digital camera uses JPEG compression. If JPEG compression is used, when the image is played back, an extremely small portion of it is lost. The higher the compression rate, the more of the original image is lost.

Therefore, in the still image mode, this digital camera also allows you to store image data at extremely low compression to ensure that a minimum of the original image is lost. This is the **[FINE]** mode. Since the image data is large when the **[FINE]** mode is used, compared to **[NORM]** compression, the digital camera requires more time both to store the data after the shutter release button is pressed and to display the image in the playback mode.

CHANGING THE SHOOTING SETTINGS

How to use the manual focus

1 Select the manual focus icon **MF** from the focus menu, and press the SET button.

2 Press the SET button.

- The focus distance adjustment bar appears.

3 Use the [◀] and [▶] arrow buttons to adjust the focus distance, and press the SET button.

- The focus distance is fixed, and you are returned to the Shooting Screen.

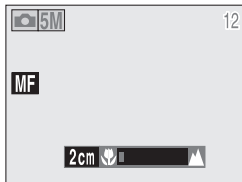

NOTE

About the focal length

- The indicated focal length is that as measured from the lens surface.
- There may be somewhat of a disparity between the focal length numerical value that is set using the manual focus and the actual distance to the subject. To confirm the focus, it is best to check that the image is in focus on the LCD monitor.

About zoom movement when using the manual focus

- If the focus distance is set to 30 cm (11.81 in) or less, the zoom is automatically set to the wide end.
- When the focus distance is set to 30 cm (11.81 in) or less, the zoom will function only within the range at which the image is focused.

White Balance Setting

This digital camera automatically adjusts the white balance under most lighting conditions. It is recommended that you adjust the white balance setting especially if specifying a light source.

1 Display the Shooting Setting Screen (see page 40), and select the white balance menu.

2 Select the desired white balance icon, and press the SET button.

[AWB]: The digital camera will make the white balance adjustment automatically based on the natural and artificial light conditions. This is the setting used in the auto mode.

: For shooting outside on a sunny day.

: For shooting outside on a cloudy day.

: For shooting inside under fluorescent lighting.

: For shooting inside under incandescent lighting.

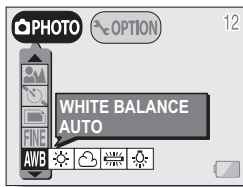

HINT

To cancel the white balance setting

- Perform step 2, select **[AWB]**, and then press the SET button.

CHANGING THE SHOOTING SETTINGS

Exposure Correction

When capturing images, you can make the image lighter or darker.

1 Cancel the Shooting Setting Screen (see page 40).

- Press the MENU button to exit the Shooting Setting Screen.

2 Press [◀] or [▶] on the arrow button.

- The exposure correction bar appears.
- At this point, you can press [◀] or [▶] on the arrow button to adjust the exposure.

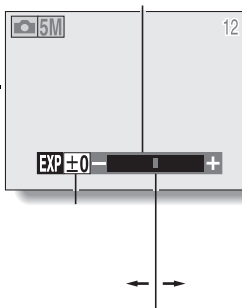

HINT

- Exposure correction setting is canceled in the following cases:
 - When the pointer is set to the center position.
 - After the shooting mode is changed.
 - When the playback mode is set.
 - After the power is turned off.
- The exposure setting numerical value is shown at the left end of the exposure bar. The exposure can be set to a value from -1.8EV to $+1.8\text{EV}$.
- The accessing indicator flashes when the exposure correction is active.
- You can also correct the exposure by selecting the exposure correction icon on the Shooting Setting Screen.

NOTE

When shooting without using the LCD monitor...

- Exposure correction is disabled.

VIEWING IMAGES

1 Set the main switch to [▶], and turn on the camera.

- The last recorded image is displayed on the LCD monitor.

2 Select the image you wish to view.

To display the previous image, press the [◀] arrow button.

To display the next image, press the [▶] arrow button.

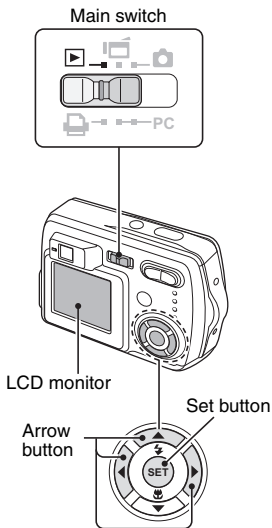

VIEWING IMAGES

3 Play back a video clip.

Normal playback

- Press the SET button.
- Pressing [◀] during a video clip playback will start reverse playback.

To pause playback

- Press the [▲] button to pause playback; press the SET button to continue playback.

To play back one image at a time (single-frame step)

- While video clip playback is paused, you can press the [▶] arrow button to view the frames in order, or [◀] to view them in reverse order.

To accelerate playback

- 2x fast forward playback: During normal speed playback, press [▶].
- 20x fast forward playback: During 2x playback, press [▶].
 - * Pressing [◀] will start reverse playback.
- For normal playback: during playback, press the SET button.

NOTE

- Sound cannot be played back.
- To play back images from the camera's internal memory, remove the card from the camera.

HINT

- If you press the shutter release button while an image is displayed, the image number will be shown. Press the shutter release button again to turn off the image number indication.

HINT

To view video clips on your computer

- You can view video clips taken with this camera on your computer using QuickTime Ver. 3.0 or later from Apple.
- By using the QuickTime Plug-in included with QuickTime, you can also play back your video clips on your Internet browser.
- QuickTime 6.5 for Windows and Macintosh is supplied with the included CD-ROM (SANYO Software Pack).
- Online information about QuickTime can be found at <http://www.apple.com/>

VIEWING IMAGES

Convenient 9-image display playback

- 1** Set the main switch to [▶], and turn on the camera.
- 2** Press [W] ([📷]) on the zoom switch.
 - The 9-image display appears.
- 3** Select the image to play back.
 - Press the [▲], [▼], [◀] or [▶] arrow button to move the orange frame to the desired image, and press the SET button.
Instead of pressing the SET button, you can press [T] ([🔍]) on the zoom switch to show the image full screen.

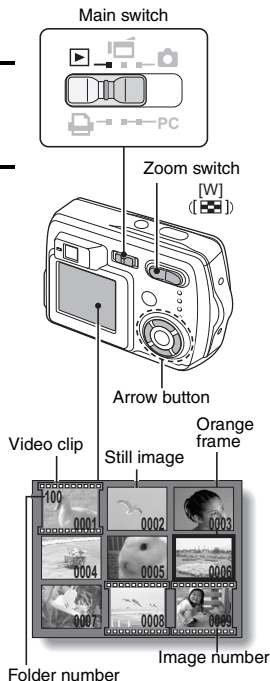

Magnifying (zooming in) the image

- 1 Display the image that you want to magnify (see pages 56 and 57).**
 - For a video clip, pause playback at the place you want to magnify.

- 2 Press [T] ([]) on the zoom switch.**

- Magnification is enabled.
- The image is magnified, and the central portion of the image is displayed.
- Use the arrow buttons to view different parts of the magnified image.

To magnify:

Press [T] ([]) on the zoom switch.

To return to normal size:

Press [W] ([]) on the zoom switch.

- The maximum degree of magnification will depend on the resolution of the original image.
- The maximum magnification is about 58x at **10M** resolution.
- If the image has been rotated, it will be returned to its original orientation and then enlarged.
- One scene (still image) of a paused video clip can be enlarged; however, a video clip cannot be played while enlarged.



HINT

The magnified portion of the image can be saved as a separate image.

- Press the shutter release button. The magnified portion is saved as a new still image.

DISPLAYING THE PLAYBACK SETTING SCREEN

To process your photographed images, select the desired menu from the Playback Setting Screen.

Displaying the Playback Setting Screen

- 1 Set the main switch to [▶], and turn on the camera (see page 23).**
 - The image that was last captured appears on the LCD monitor.

- 2 Press the MENU button.**
 - The Playback Setting Screen appears.

- **To cancel the Playback Setting Screen**
 - Press the MENU button.



Playback Setting Screen

* All the icons never appear at the same time.

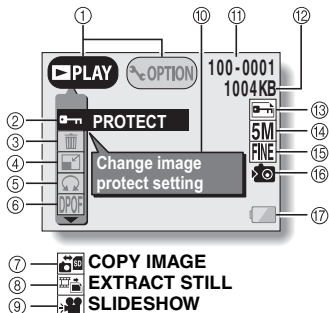

- | | |
|--|--|
| ① Setting/option switch (see page 81) <ul style="list-style-type: none">• Switch between the Playback Screen and the Option Screen. | ⑧ Extract still image |
| ② Data protect setting (prevent accidental erase) | ⑨ Slideshow settings and playback |
| ③ Data erase | ⑩ HELP display |
| ④ Resize | ⑪ Image number |
| ⑤ Rotate image | ⑫ Data size |
| ⑥ Print settings | ⑬ Protect mark |
| ⑦ Copy image data <ul style="list-style-type: none">• Displayed only when there is a card installed. | ⑭ Resolution |
| | ⑮ Compression rate |
| | ⑯ Internal memory icon |
| | ⑰ Remaining battery charge |
- Icons ⑦ through ⑨ on the Playback Setting Screen are displayed when you press the [▲] or [▼] arrow button to scroll down the screen.

CHANGING IMAGE SIZE (RESIZE)

For a still image that was captured using a higher resolution than **WEB**, you can change the size to 640 × 480 pixels or 320 × 240 pixels and save it as a separate still image.

1 Display the still image whose size you want to change.

2 Display the Playback Setting Screen (see page 61).

3 Select the resize icon , and press the **SET** button.

- The Resize Screen appears.



4 Press [▲] or [▼] on the arrow button to select the new image size.

640: The saved image will be 640 × 480 pixels.

320: The saved image will be 320 × 240 pixels.

EXIT: Return to the Playback Setting Screen.

5 Press the **SET** button.

- The Confirm Size Change Screen appears.

6 Select “**YES**”, and press the **SET** button.

- Resizing begins.
- When resizing is completed, you are returned to the Playback Setting Screen.



ROTATING AN IMAGE



Captured images can be rotated to the correct orientation for viewing.

1 Display the still image you want to rotate.

2 Display the Playback Setting Screen (see page 61).

3 Select the rotate image icon , and press the SET button.

- The Rotate Image Screen appears.

- : Rotates image clockwise 90 degrees
- : Rotates image counterclockwise 90 degrees
- EXIT**: Return to the Playback Setting Screen.

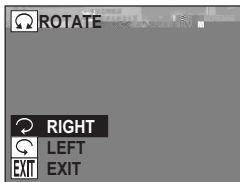

4 Select the rotate right icon  or rotate left icon , and press the SET button.

- Each time the SET button is pressed, the image is rotated another 90 degrees.

SLIDESHOW PLAYBACK

- 1** Display the still image or video clip to play back, and display the Playback Setting Screen (see page 61).
-

- 2** Select the slideshow icon , and press the SET button.

- The Slideshow Screen appears.

STILL Only still images are played
IMAGE: back in the slideshow.

VIDEO Only video clips are played
CLIP: back in the slideshow.

MIX: Still images and video clips are played back in the slideshow.

EXIT: Return to the Playback Setting Screen.



<When **STILL IMAGE** or **MIX** is selected>

- Select "TIME" or "EFFECT", press the SET button.
- Press [▲] or [▼] on the arrow button to select the desired setting.
- Press the SET button.

- 3** Select "START", and press the SET button.

- Slideshow playback is canceled when the SET button, MENU button or an arrow button is pressed.

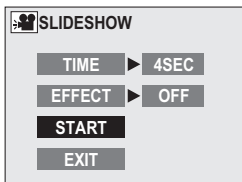

OTHER PLAYBACK FUNCTIONS

Image protect mode (Prevent accidental erasure)

By using the image protect mode, you can prevent accidental erasure or overwriting of the important data that you want to keep.

- 1 Display the data that you want to protect.
- 2 Display the Playback Setting Screen (see page 61).
- 3 Select the protect icon .

- 4 Press the SET button.
 - “LOCK?” appears.
 - If the protect mode has already been enabled for the data, then “UNLOCK?” appears.

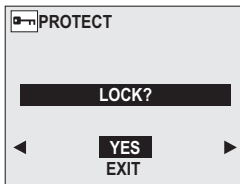

- 5 Select “YES”, and press the SET button.
 - The protect mode is set for the data.
 - The protect mark  indicates that the data is locked.

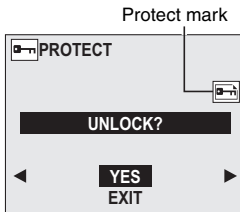

CAUTION

- Even if the protect mode is set for certain data files, they will be erased if the card is reformatted (see page 90).

HINT**To select a different image in steps 4 and 5...**

- Press [◀] or [▶].

To cancel the protect mode for an image...

- Display the desired data and repeat steps 2 to 5. The protect mark will disappear and the protect mode is canceled.

OTHER PLAYBACK FUNCTIONS

Erasing Data

Images and video clips can be erased one at a time, or all at once.

1 Display the data that you want to erase.

2 Display the Playback Setting Screen (see page 61).

3 Select the erase icon  and press the SET button.

- The Erase Screen appears.

For still images:

ONE ERASE: Erases one still image at a time.

ERASE ALL: Erases all the images.

For video clips:

ONE ERASE: Erases the video clip displayed.

ERASE ALL: Erases all the images.

- Select "EXIT", and press the SET button, to return to the Playback Setting Screen.

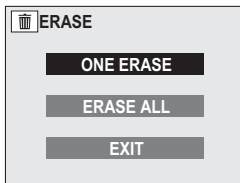

-
- 4** Press [▲] or [▼] on the arrow button to select the desired type of erase, and press the SET button.

- The Erase Confirmation Screen appears.

YES: Erases the selected data.

EXIT: Does not erase the selected data and returns to the Erase Screen.



-
- 5** Press [▲] to select “YES”, and press the SET button.

- “ERASING” is displayed, after which the next image appears. The data is erased.
- To erase other data, select “EXIT”, press [◀] or [▶] to display the data that you want to erase and repeat step 5.

HINT

To select a different data in step 4...

- If “ONE ERASE” is selected, select “EXIT”, and press [◀] or [▶] on the arrow button to select different data.

HINT

To quickly erase the currently displayed image

- ① Display the image you want to erase.
- ② Press the arrow [▲] ([⏏]) button.
 - The Erase Confirmation Screen appears.
- ③ Select “YES”, and press the SET button.
 - The displayed image is erased.

OTHER PLAYBACK FUNCTIONS

Copy image data

You can copy your photographed images from the camera's internal memory to a card, and vice versa.

1 Insert a card in the camera (see page 22).

2 Display the Playback Setting Screen (see page 61).

3 Select the copy image icon  and press the SET button.

- The Copy Image Screen appears.
- Press the [▲] or [▼] arrow button to select the copy source.

INT MEM ► CARD:

Image data is copied from the internal memory to the card.

INT MEM ◀ CARD:

Image data is copied from the card to the internal memory.



- If a card is not inserted in the camera, you cannot select the copy image icon .

4 Press the SET button.

- The screen appears for you to select whether to copy only the image currently shown or to copy all the images from the card or the internal memory. Press the [▲] or [▼] arrow button to make your selection.

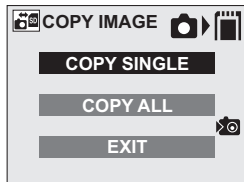

5 Press the SET button.

- The Copy Confirmation Screen appears. To proceed with copying, select "YES" and press the SET button.
- To copy other data, press [◀] or [▶] to display the data that you want to copy and press the SET button.
- If you wish to cancel the copy procedure and return to the Copy Image Screen, press the MENU button, or select "EXIT" and press the SET button.

OTHER PLAYBACK FUNCTIONS

Extracting a Still Image From a Video Clip

You can select one image (scene) from a video clip, copy it, and save it as a still image (the original data remains unchanged).

1 Play back a video clip, and pause at the point you wish to copy and save (see pages 56 and 57).

2 Display the Playback Setting Screen (see page 61).

3 Select the extract still icon , and press the SET button.

- The screen to extract an image appears.

YES: The image is copied and saved as a still image (the original data is left unchanged).

EXIT: The still image extraction procedure is canceled, and you are returned to the Playback Setting Screen.



4 Select "YES", and press the SET button.

- The image is extracted.
- Select "EXIT", and press the SET button, or press the MENU button, to return to the Playback Setting Screen.

HINT

To select a different image (frame) in step 3...

- Press [◀] or [▶] on the arrow button.

Print Settings (DPOF setting)

In addition to using your printer to print out still images captured with your camera, as with conventional film, you can have prints made at shops offering digital print services. Moreover, this camera is DPOF-compatible, so you can use the camera to specify the number of prints, whether or not the date is displayed on the print, and also to specify an index print.

Display the Print Settings Screen

1 Display the Playback Setting Screen (see page 61).

2 Select the print settings icon , and press the SET button.

- The Print Settings Screen appears.

ALL IMAGES: The specified print settings apply to all the still images.

EACH IMAGE: The print settings are specified for each individual image.

INDEX: All the still images are printed as miniature images (thumbnail images), several images on one print.

ALL CLEAR: Clear all the print settings. This cannot be selected if no print settings have been made for the image.

EXIT: Return to the Still Image Playback Setting Screen.

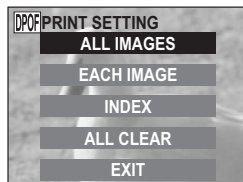

OTHER PLAYBACK FUNCTIONS

HINT

- To print with a printer or have the digital print service shop print out a still image from a video clip, you must first save it (save frame (see page 73)) as a still image.

HINT

About the DPOF format

- DPOF (Digital Print Order Format) is a print order format. You can connect your camera to a DPOF-compatible printer to produce your prints. You can also set the print settings for the desired images, and then have the reserved images printed automatically.

About the finished prints

- Images that have been rotated will be printed in their original orientation.
- The quality of the print output will differ depending on the print service and printer used.

Specifying date imprinting and print quantities

You can specify print settings for each individual image (EACH IMAGE), or apply the print settings to all the images on the card (ALL IMAGES).

1 Display the Print Settings Screen (see page 74).

2 Select EACH IMAGE or ALL IMAGES.

ALL IMAGES: The set print settings are applied to all the still images on the card.

EACH IMAGE: The set print settings are applied only to the image currently displayed.

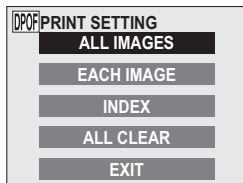

3 Press the SET button.

- The Date/Number Print Screen appears.
- If EACH IMAGE was selected, press the [◀] or [▶] arrow button display the desired image to print.
- Under "SETTINGS" the settings that are currently active for the displayed image are shown. You can press the [◀] or [▶] arrow button to confirm the print settings for each image.

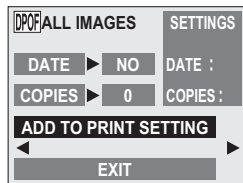

OTHER PLAYBACK FUNCTIONS

4 Specify whether the date is displayed on the print, and the number of prints.

<Specifying dated prints>

- ① Press the [▲] or [▼] arrow button to select "DATE".
- ② Press the SET button.
 - The Print Date Screen appears.
- ③ Press the [▲] or [▼] arrow button to select the desired option.
YES: Print the date.
NO: Do not print the date.
- ④ Press the SET button.
 - You are returned to the Date/Number Print Screen.

<Specifying the number of prints>

- ① Press the [▲] or [▼] arrow button to select "COPIES".
- ② Press the SET button.
 - The Print Number Screen appears.
- ③ Press the [▲] or [▼] arrow button to specify the number of prints.
 - Press the [▲] or [▼] arrow button until the desired number of prints is displayed.
- ④ Press the SET button.
 - You are returned to the Date/Number Print Screen.

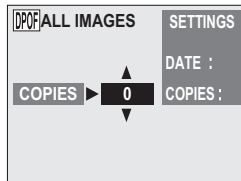
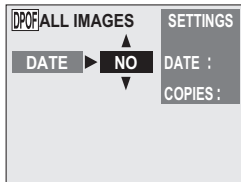

5 Select “ADD TO PRINT SETTING” and press the SET button.

- The Confirm Print Settings Screen appears.

If the print settings are correct:
Select “EXIT”, and press the SET button.

If the print settings were changed:

Select “MODIFY PRINT SETTING”, and press the SET button.

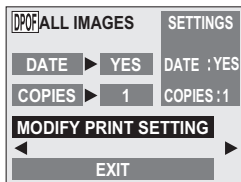

Index print

Printing out many small images on one sheet is called an “index print.” This is convenient for use as a list of the images you have captured.

1 Display the Print Settings Screen (see page 74).

2 Select “INDEX”.

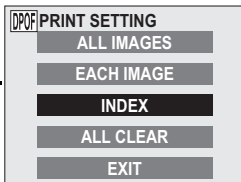

OTHER PLAYBACK FUNCTIONS

- 3** Press the **SET** button.
- The Index Print Screen appears.
- YES:** Specify an index print copy.
- EXIT:** Discontinue the setting procedure, and return to the Print Setting Screen.



- 4** Select **“YES”**, and press the **SET** button.
- This completes the setting for the index print. You are returned to the Print Settings Screen.

Changing the print settings

- 1** Follow steps 1 to 4 on pages 76 and 77.
- 2** Select **“MODIFY PRINT SETTING”**, and press the **SET** button.

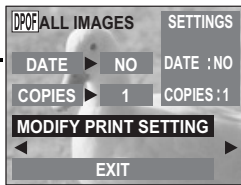

Clearing all the print settings

Delete the print settings for all images.

1 Display the Print Settings Screen (see page 74).

2 Select "ALL CLEAR".

3 Press the SET button.

- The Confirm All Clear Screen appears.

YES: Clear the print settings for all images.

EXIT: Cancel the clear procedure and return to the Print Settings Screen.



4 Select "YES", and press the SET button.

- All the print settings are cleared and you are returned to the Print Settings Screen.

CHANGING THE CAMERA SETTINGS

You can change the camera settings by selecting the desired menu from the Option Screen and modifying the settings.

To display the Option Screen

- 1 Set the main switch to the desired mode.

For a Shooting Option Screen:

Set to [] or [].



For the Playback Option Screen:

Set to [].

- 2 Press the MENU button.

- 3 Press the [▲] or [▼] arrow button to select the shooting settings/camera settings switch (see pages 42, 44 and 62).

- 4 Press the [▶] arrow button to select the  icon.

When the main switch is set to [] or []:

The corresponding Shooting Option Screen appears (see page 82).

When the main switch is set to []:

The Playback Option Screen appears (see page 82).

■ To cancel the Option Screen

- Press the MENU button.

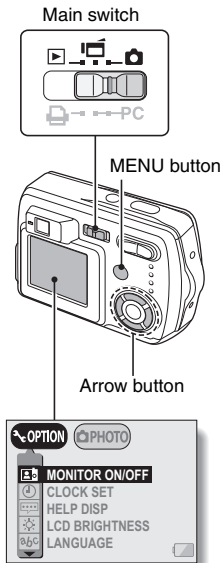

Option screen

* [] and [] will appear at the same time.



- | | |
|--|---|
| ① Shooting settings/camera settings switch | ⑦ Card reformat (format) |
| ② Monitor ON/OFF setting | ⑧ Power save |
| ③ Date and time setting | ⑨ File No. Reset |
| ④ Help display settings | ⑩ Reset settings |
| ⑤ Monitor brightness | ⑪ Playback setting/camera settings switch |
| ⑥ Screen display language | ⑫ Internal memory icon |

- Icons ⑦ through ⑩ in the Shooting Option Screen, and icons ⑧ through ⑫ in the Playback Option Screen are displayed when you press the [▲] or [▼] arrow button to scroll down the screen.

LCD MONITOR SETTING

Set the LCD monitor to on or off

You can save battery power by turning off the LCD monitor when shooting.

1 Display the Shooting Option Screen (see page 81).

2 Select the monitor ON/OFF icon

, and press the SET button.

- The Monitor Screen appears.
ON: The LCD monitor is on.
OFF: The LCD monitor turns off.

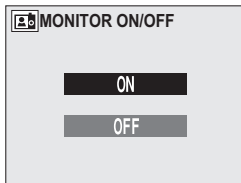

3 Select the desired setting, and press the SET button.

- If "OFF" was selected, the LCD monitor turns off.
- To turn the LCD monitor back on, press the MENU button to illuminate the LCD monitor, and perform steps 1 and 2 above to select the ON icon.

LCD MONITOR BRIGHTNESS

- 1 Display the Option Screen (see page 81).**
- 2 Select the monitor brightness icon , and press the SET button.**
 - The Monitor Brightness Screen appears.
- 3 Press the [◀] or [▶] arrow button.**
 - Pressing [◀] makes the screen darker, and pressing [▶] makes it lighter.
- 4 Press the SET button.**
 - You are returned to the Option Screen.

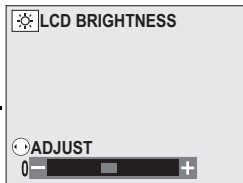

NOTE

- The LCD monitor brightness cannot be adjusted when the LCD monitor is set to OFF.

DATE AND TIME SETTING

The digital camera will record the date and time an image is taken so that you can display them during playback. Therefore, before capturing images, make sure the correct date and time are set.

Example: To set the clock to 7:30 p.m. on December 23, 2005

1 Display the Option Screen (see page 81).

2 Select the clock set icon , and press the SET button.

- The Clock Set Screen appears.
- The current date and time settings appear.
- Follow the procedures below to enable or disable the date display during playback, to set the display format for the date, and to set the date and time.
- To return to the Option Screen, press the MENU button, or select "EXIT" and press the SET button.

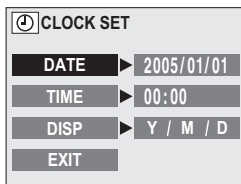

3 Set the date.

- ① Press the arrow button to select "DATE".
- ② Press the SET button.
 - The Set Date Screen appears.
- ③ Press the arrow button to set the date to "2005/12/23".
 - Year setting → [▶] → Month setting → [▶] → Day setting.
 - Press [▲] to increase the number.
 - Press [▼] to decrease the number.
- ④ Press the SET button.

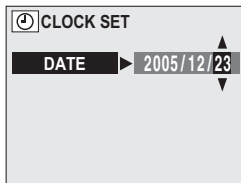

4 Set the clock.

- ① Press the arrow button to select "TIME".
- ② Press the SET button.
 - The Set Time Screen appears.
- ③ Press the arrow button to set the time to "19:30".
 - Hour setting → [▶] → Minute setting.
 - A 24-hour clock is used for the time display.
- ④ Press the SET button.

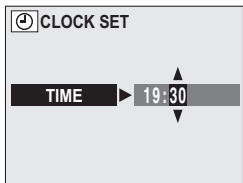

DATE AND TIME SETTING

5 Set the order in which the date is displayed during playback.

- ① Press the arrow button to select "DISP".
- ② Press the SET button.
 - The Set Date Format Screen appears.
- ③ Press [▲] or [▼].
 - When [▲] is pressed, the displayed date order changes as follows:

→ year/month/day → month/day/year → day/month/year → DISP OFF (no display) →

Press [▼] to change in the reverse order.

- If "DISP OFF" is selected, the date the image was captured is not shown during playback.
- ④ Press the SET button.

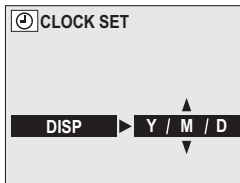

6 Select "EXIT", and press the SET button.

- The date and time setting is completed, and you are returned to the Option screen.

NOTE

- Under normal conditions, while the battery is being replaced, an internal battery will maintain the date and time settings. However, there is a small chance the settings may be lost. (The backup will last for about 7 days.) It is recommended to check that the date and time settings are still correct after replacing the batteries and before shooting or recording of any type (follow steps 1 and 2). Also, when the backup memory has failed and the camera's clock is not set, the clock alert icon  appears.

To correct the date and time settings

- After steps 1 and 2, press [▼] on the arrow button to select the line of the setting that you want to change, and press [▶] to select that setting. Then press [▲] or [▼] to set the new setting.

HELP DISPLAY

You can set whether or not the help display for the Shooting and Playback Setting Screens is shown.

1 Display the Option Screen (see page 81).

2 Select the help display icon , and press the SET button.

- The Set Help Display Screen appears.

ON: The help display is shown.

OFF: The help display is not shown.

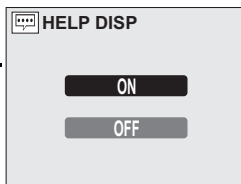

3 Select the desired setting, and press the SET button.

- You are returned to the Option Screen.

LANGUAGE

You can set the LCD monitor of your digital camera to display the messages in any of several languages.

1 Display the Option Screen (see page 81).

2 Select the language icon , and press the SET button.

- The Language Screen appears.

DEUTSCH: Select for German.

ENGLISH: Select for English.

ESPAÑOL: Select for Spanish.

FRANCAIS: Select for French.

ITALIANO: Select for Italian.

NEDERLANDS: Select for Dutch.

РУССКИЙ: Select for Russian.

日本語: Select for Japanese.

한국어: Select for Korean.

中文(繁): Select for Chinese (traditional).

中文(简): Select for Chinese (simplified).

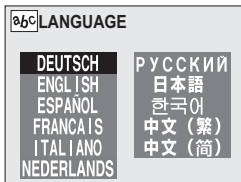

3 Select the desired language, and press the SET button.

- You are returned to the Option Screen.

INITIALIZING THE CARD MEMORY AND INTERNAL MEMORY

A card must be formatted with this camera:

- After purchasing, when used for the first time, or
- If it was formatted using a personal computer or another digital camera.

The card cannot be reformatted if the lock switch is set to the "LOCK" position. Proceed with the reformat procedure after setting the lock switch to the unlocked position (see page 67).

1 To reformat a card, install it in the camera. To reformat the camera's internal memory, remove the card from the camera.

2 Display the Option Screen (see page 81).

3 Select the format icon , and press the SET button.

- The Format Screen appears.
- In normal use, a full format is not necessary. However, in case a card error occurs even after normal formatting, executing a full format may resolve the problem.

FORMAT:

A normal formatting is executed.

FULL FORMAT:

The entire card is scanned and reformatted. It is not possible to select this when there is no card installed, or when the remaining battery charge is low.

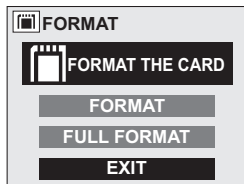

<With card installed>

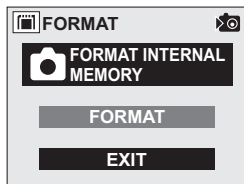

<No card installed>

INITIALIZING THE CARD MEMORY AND INTERNAL MEMORY

4 Select the desired format option, and press the SET button.

5 Select "YES".

6 Press the SET button.

- Formatting begins.
- During formatting, "FORMATTING" and "DO NOT POWER OFF" are shown on the LCD monitor.

CAUTION

Caution during reformatting

- Please do not turn off the camera or insert/remove the card while the card is being formatted.

Reformatting erases the data

- When the card or internal memory is initialized, all the recorded data is erased. Protected data (see page 67) is also erased, so before reformatting a card, any data you want to keep should be copied to your personal computer's hard disk or other storage medium.

Can data be restored after a card is formatted?

- It may be possible to restore data from a reformatted card by using application software designed to restore data. However, even such application software cannot restore data after a full format has been executed. It is recommended that a full format be executed before you dispose of a card or transfer it to someone else.

HINT

To cancel reformatting

- In step 5, select "NO", and press the SET button.

POWER SAVE SETTING

Your camera has a “power save” function whereby the power automatically turns off after a specified period of inactivity. The power save function works to conserve the battery power when the camera is not being used, or to prevent the batteries from dying if the camera has accidentally been left on. You can specify the elapsed time (standby time) before the power save function is activated.

1 Display the Option Screen (see page 81).

2 Select the power save icon **[PS]**, and press the **SET** button.

- The Power Save Screen appears.

BATT/CAM: Set the standby time for the shooting modes when the batteries are used.

BATT/PB: Set the standby time for the playback mode when the batteries are used.

**EXT.PWR/
CAM.PB:** Set the standby time for the shooting and playback modes when the AC adapter is connected.

EXIT: Return to the Option Screen.

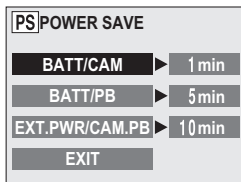

POWER SAVE SETTING

3 Press [▲] or [▼] on the arrow button to select the desired option.

4 Press the SET button.

- The Set Standby Time Screen appears.

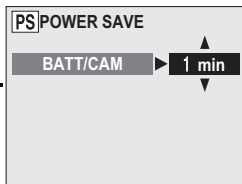

5 Press [▲] or [▼] on the arrow button to set the standby time.

[▲]: Increases the standby time.

[▼]: Decreases the standby time.

6 Press the SET button.

- The standby time is set, and you are returned to the Power Save Screen.

FILE NO. RESET FUNCTION

If a reformatted card is used, the file name (image number) of the captured image automatically begins from 0001. If the card is subsequently reformatted, or if a different reformatted card is used, the file names again begin from 0001. This is because the file number reset function is set to ON, and consequently it results in more than one card containing images with the same numbers. By setting the file number reset function to OFF, even if the card is reformatted or the card is replaced with another card, the consecutive numbering of file names continues from the last number recorded by the camera.

<File number reset function ON>

	File name (image number)
Card A	0001, 0002 0012, 0013

:
Replace card
↓

Card B	0001, 0002 0012, 0013
--------	-----------------------------

<File number reset function OFF>

	File name (image number)
Card A	0001, 0002 0012, 0013

:
Replace card
↓

Card B	0014, 0015 0025, 0026
--------	-----------------------------

- If Card B already has image data in it when it replaces Card A, file names are assigned as follows.
 - When the highest image number on Card B (before replacing) is lower than the highest image number on Card A: the file name of the next recorded image continues from last file name recorded on Card A.

Card A	0001, 0002..... 0012, 0013
--------	----------------------------

:
Replace card
↓

Card B	0001, 0002, 0014, 0015, 0025, 0026
--------	------------------------------------

Previously recorded images

FILE NO. RESET FUNCTION

- When the highest image number on Card B (before replacing) is higher than the highest image number on Card A: the file name of the next recorded image continues from last file name recorded on Card B.



1 Display the Option Screen (see page 81).

2 Select the file number reset icon .

3 Press the SET button.

- The File Number Reset Screen appears.

ON: The file number reset function is on.

OFF: The file number reset function is off.



4 Select “OFF”, and press the SET button.

- The file number reset function is deactivated.

NOTE

- Until the file number reset function is turned ON, consecutive file names are assigned. It is recommended that the file number reset function be returned to ON at the end of each photography session.

RESETTING THE CAMERA SETTINGS

The settings that were changed on all the setting screens can be reset to the factory-preset settings.

1 Display the Option Screen (see page 81).

2 Select the reset settings icon , and press the SET button.

- The Reset Settings Screen appears.

YES: Reset to the factory-preset settings.

NO: Do not change the settings, and return to the Option Screen.

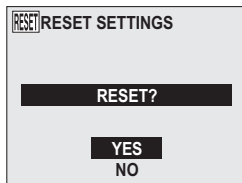

3 Select "YES", and press the SET button.

- The camera settings are reset to the factory-preset settings.
-

HINT

- Note that the following settings do not change with this procedure:
 - Date and time setting
 - Language setting

CHECKING THE REMAINING CARD MEMORY AND INTERNAL MEMORY

You can check how many images can be captured and how much recording time is available on the card or in the camera's internal memory. For a table showing the maximum number of images and recording time for specific cards, please see "Possible No. of Images/Possible Shooting Time" on page 132.

Checking the remaining number of images and video recording time

1 Set the camera to the desired shooting mode (see pages 29 and 30).

- The remaining number of images appears in the upper right of the LCD monitor (for the still image and sequential shots shooting modes).
- The remaining video recording time appears in the upper right of the LCD monitor (for the video clip shooting mode).
- The remaining number of images and video recording time will differ depending on the resolution and compression settings.
- When the remaining number of images or the remaining video recording time is "0", it may be possible to capture a few more images by changing the shooting mode, setting a lower resolution setting (see page 50), or selecting a different compression setting (see page 51).

Remaining number of images

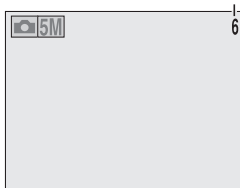

<Still image/sequential shots mode>

Remaining time (min:sec)*

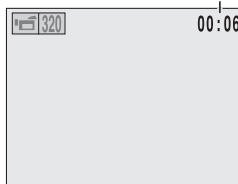

* Depending on the card capacity, hr:min:sec
<Video clip shooting mode>

CHECKING THE REMAINING BATTERY CHARGE



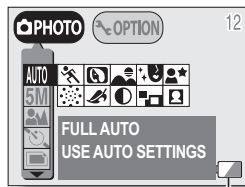

When using the batteries, the remaining battery charge can be checked on the LCD monitor. Make sure to check this indicator before capturing an image. Please see page 131 for information regarding the battery life.

1 Display a Shooting or Playback Setting Screen (see pages 40 and 61).

- The battery remaining charge indicator appears in the lower right corner of the LCD monitor.
- Due to the battery characteristics, when the ambient temperature is low,  may appear early for an incorrect indication of the remaining charge. Also, depending on the conditions of use of the digital camera or the ambient conditions (temperature, etc.), the indicated remaining charge may change. Therefore, this indication can only be used as a general approximation of the remaining charge.



Remaining charge indicator

Battery remaining charge indicator	Battery remaining charge
	Approx. full. Appears only when a Shooting or Playback Setting Screen is shown.
	Power is low. Appears only when a Shooting or Playback Setting Screen is shown.
	It will soon be impossible to capture or play back images.
	If this icon flashes when the shutter release button is pressed, images cannot be captured. Replace the batteries.

CHECKING THE REMAINING BATTERY CHARGE

HINT

- Battery life may differ even among batteries of the same type.
- Depending on the usage of the digital camera (such as the number of times the flash is used, the use of the LCD monitor, etc.) or the environmental conditions (temperature, etc.) the number of images that can be saved on fully charged batteries will vary greatly.

NOTE

- It is recommended that you prepare extra batteries when taking pictures at a wedding or while traveling, for example, so you don't miss capturing images of important moments due to the battery power running out. The same is recommended for taking photos in cold environments. (In a ski area, for example, the batteries can be kept warm in your pocket until ready to use.)

CONNECTING TO A COMPUTER

How to connect your camera to a computer

- 1 Turn off your digital camera (see page 24).
- 2 Using the supplied dedicated USB interface cable, connect the camera connector to the camera and the computer connector to the proper terminal on your computer.

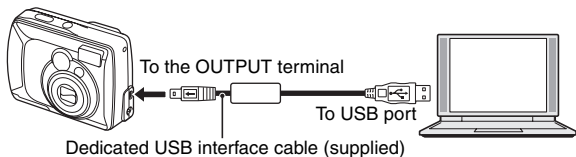

- Please connect the dedicated USB interface cable to your computer's USB connector. Do not connect it to the USB port on your monitor or keyboard, or to the USB hub. Be especially careful when installing the driver software. In some instances, it may not be possible to correctly install the driver software.

- 3 Set the main switch to [PC], and turn on the power.

- The screen to confirm the connection appears.

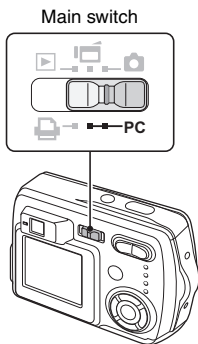

CONNECTING TO A COMPUTER

4 Select "OK" and press the SET button.

- The camera changes to the PC connection mode.
- To continue the procedure, please read the Instruction Manual for the SANYO Software Pack.

NOTE

- When the digital camera is set to the PC connection mode, no image is shown on the LCD monitor.

Data file formats

The format of the files saved on the card and the method in which the file names are determined are explained below.

Type of data	Data format	File name structure
Still image data /sequential shots data	JPEG	File name begins with SANY. Extension is ".jpg". SANY****.jpg
Video clip data	QuickTime Movie	File name begins with VCLP. Extension is ".mov". VCLP****.mov*

* Consecutive numbers assigned in the order the data was saved.

Configuration of directories for the stored data

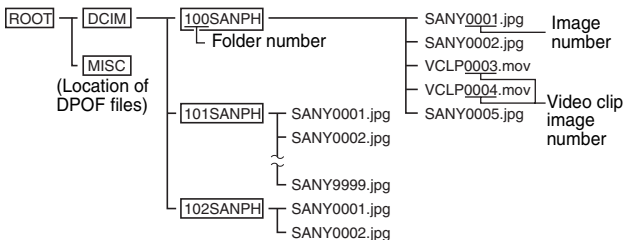

* Up to 9,999 files can be stored in folder 100SANPH. If more files are made, a folder named 101SANPH will be made and they will be stored in there. New folders will then be named in sequence, i.e., 102SANPH, 103SANPH, etc.

NOTE

Do not modify the folders and file names in the card using your computer

- If the folders, file names, or their configuration is modified using a personal computer, it will be impossible to play back the data using the digital camera, and the digital camera may not operate properly.

Concerning video clip data saved by the digital camera

- You can use QuickTime 3 or later from Apple to play back the video clips. QuickTime 6.5 for Windows and Macintosh is supplied with the included CD-ROM (SANYO Software Pack).

About file names when the card is replaced...

- If the file number reset function is set to off, even when the card is replaced, consecutive numbering of folder numbers and file names continues from the previously installed card.

DIRECT-PRINT

Your digital camera supports the PictBridge function. By connecting the digital camera directly to a PictBridge-enabled printer, the digital camera's LCD monitor can be used to select images and initiate printing.

Print preparations

1 Install the card containing the images you want to print in the digital camera.

- If there is no card installed in the camera, the image data from the camera's internal memory will be printed.

2 Use the supplied USB interface cable to connect the camera to the printer.



NOTE

Do not turn off the power to the printer while it is connected.

- If the power to the printer is turned off while it is connected, the camera may not operate correctly. If the camera does not operate correctly, disconnect the dedicated USB interface cable, turn off the camera, and then reconnect the cable.

3 Turn on the power to the printer.

4 Set the main switch to [].

- The screen to confirm the connection appears.

5 Select “OK” and press the SET button.

- The camera changes to the PictBridge printing mode, and the Print Settings Screen appears.

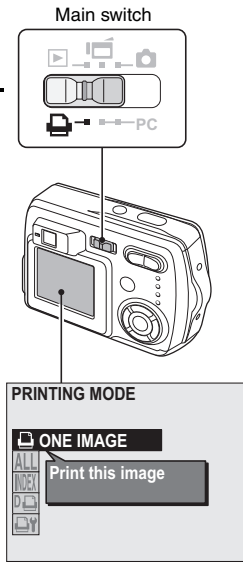

CAUTION

- During PictBridge printing, the camera's button operation response is slower.
- If the camera is powered by batteries for printing, make sure that the remaining battery charge is sufficient (see page 98).

DIRECT-PRINT

To select one image and print it (print select image)

Procedure to select one still image and print it.

1 Complete the print preparations (see page 103).

2 Select the choose print image icon , and press the SET button.

- The screen to select images for printing appears.



3 Press the [◀] or [▶] arrow button to display the image you wish to print.

4 Specify the number of prints.

- ① Select "COPIES", and press the SET button.
- ② Press the [▲] or [▼] arrow button to set the number of prints.
- ③ Press the SET button.
 - "PRINT" is selected.

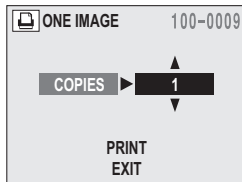

5 Press the SET button.

- Printing begins.

NOTE

To cancel printing

- ① During printing, press the [▼] arrow button.
 - The Confirm Cancel Printing Screen appears.
- ② Select "YES", and press the SET button.
 - If "NO" is selected, printing resumes.

DIRECT-PRINT

To print all the images (print all)

Print all of the images on the internal memory or card.

1 Complete the print preparations (see page 103).

2 Select the all images print icon **ALL**, and press the **SET** button.

- The Print All Images Screen appears.



3 Select **“PRINT”**, and press the **SET** button.

- Printing begins.

NOTE

Printing is not possible if there are more than 1,000 still images in the card.

- Delete unwanted images before printing.

Thumbnail prints (index print)

1 Complete the print preparations (see page 103).

2 Select the index icon , and press the SET button.

- The Index Print Screen appears.

3 Select “PRINT”, and press the SET button.

- Printing begins.

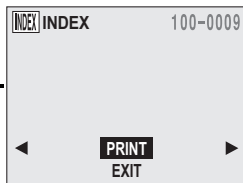

DIRECT-PRINT

To print the images that are set to print (print reserved images)

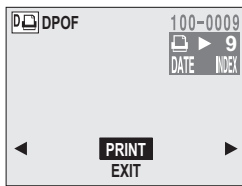

- 1 Make the print settings (see page 74), and complete the print preparations (see page 103).
-

- 2 Select the DPOF icon , and press the SET button.
 - The DPOF Screen appears.



- 3 Select "PRINT", and press the SET button.
 - Printing begins.
 - Printing begins about 1 minute after the SET button is pressed.
-

HINT

- In step 2, if you press the [] or [] arrow button, you can confirm the images that are set to print.
-

NOTE

- Reserved images print  is not possible if a printer is used that does not support your camera's DPOF function.

To change the print settings and print images (change print settings)

Images can be printed according to settings specified by the digital camera, such as paper type, size, layout, printing quality, etc.

1 Complete the print preparations (see page 103).

2 Select the printer settings icon , and press the SET button.

- The Printer Settings Screen appears.

MEDIA TYPE: Specify the type of paper used for printing.

PAPER SIZE: Specify the size of paper used for printing.

LAYOUT: Specify how the images are to be arranged on the paper.

QUALITY: Select the print quality for the images.

DATE STAMP: Print the date the photo was taken.

EXIT: Return to the Printing Mode Screen.

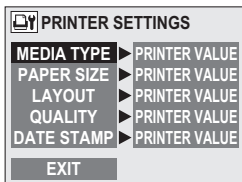

DIRECT-PRINT

3 Adjust the printer settings.

- ① Press the [▲] or [▼] arrow button to select the printer setting parameter, and press the SET button.
 - The screen to set the selected parameter appears.
 - ② Press the [▲] or [▼] arrow button to adjust the setting, and press the SET button.
 - The selected parameter is set, and you are returned to the Printer Settings Screen.
 - Follow the same procedure to adjust the other parameters, as desired.
 - The contents of the settings that can be made for each parameter will differ depending on the printer.
- <When “PRINTER VALUE” is selected>**
- The images will be printed according to the setting specified on the printer side.

4 Select “EXIT”, and press the SET button.

- You are returned to the Printing Mode Screen.

NOTE

- For special print functions such as borderless prints, the camera's settings may not be effective depending on the connected printer.

HINT

The parameters for the printer settings will differ depending on the printer that is connected.

To use printing functions that do not appear on your camera's Printer Settings Screen

- Change the printer settings on the printer side. You will be able to print using the functions you specify on the printer.

If your printer does not have the functions that you have set with your camera

- The camera's printer settings will automatically change to “PRINTER VALUE” and the images will be printed according to the settings specified on the printer side.

When your printer does not have certain print functions and the functions do not appear on the Printer Settings Screen

- It is not possible to print using those functions.

COMMONLY ASKED QUESTIONS

If you have a question about the camera operation, you might find the answer in this compilation of commonly asked questions.

	Question	Answer	Action
Power	Why doesn't the power turn on?	Due to cold temperatures, the batteries temporarily lost their power.	Place the digital camera in your pocket to warm it up before using it.
	The batteries are quickly consumed.	The ambient temperature is very low.	Keep the batteries in an environment of 10 to 40°C (50 to 104°F).
	Why does the  icon appear?	The remaining battery power is low.	Use a separately sold AC adapter (model VAR-G4AEX for Europe, U.K. and others, and model VAR-G4AU for North America and others), or replace with new batteries.
	While the flash is recharging, why does the LCD monitor suddenly turn off?	Battery power is low, activating the function that momentarily turns off the LCD monitor.	Not a malfunction. When the flash is fully charged, the LCD monitor will turn on again.





COMMONLY ASKED QUESTIONS

	Question	Answer	Action
Shooting	Why isn't the image captured when the shutter release button is pressed?	The accessing indicator is flashing (data is being recorded).	Please shoot the picture after the accessing indicator changes to the lit condition.
	The accessing indicator is flashing.	The saved data is being stored on the card or in the internal memory.	Not a malfunction. Wait until the accessing indicator changes to lit before capturing the image.
	Why doesn't the flash operate?	The digital camera has determined that the image is bright enough and the flash is not necessary.	Not a malfunction. Capture the image; the digital camera will determine when the flash is necessary.

	Question	Answer	Action
Shooting	During macro photography, why is the captured image displaced from the image as seen through the viewfinder?	Due to the displacement between the camera lens and the viewfinder, a subject viewed close up through the viewfinder will appear lower in the captured image.	Compose the photo while viewing the LCD monitor.
	Are the settings retained even after the camera is turned off?	—	All settings except the exposure correction are retained even after the camera is turned off. Set the self-timer setting each time you take a photo; however, if you change the setting but do not take the photo, the setting is retained even after the camera is turned off.

COMMONLY ASKED QUESTIONS

	Question	Answer	Action
Shooting	Why does the clock warning icon  appear?	The camera's date and time settings have not been set.	Set the date and time.
	Which resolution setting should I use?	—	Select the resolution setting according to the intended use: [10M 5M] : Appropriate for printing letter-size or larger, and for printing a close-up of part of a photo (trimming). [2M] : For printing standard photo (photo service) sizes. [WEB] : For photos displayed on a web page, or sent as e-mail attachments.

	Question	Answer	Action
Shooting	What is the difference between the digital zoom and the optical zoom?	—	Because shooting with the optical zoom uses the optics of a physical lens, you can shoot without losing minute details in the image. The digital zoom, on the other hand, works by magnifying a portion of the image that hits the CCD sensor and may produce a coarser image.
	How can I get the distant view into focus?	—	Set the focus range to infinity  .
	How can I take photos using slow synchro?	—	<p>① Set the scene select setting to night view .</p> <p>② Set the flash mode to a mode other than flash off .</p> <ul style="list-style-type: none"> • In the forced flash  mode, slow synchro shooting is ensured.

COMMONLY ASKED QUESTIONS

	Question	Answer	Action
LCD monitor	When used in cold weather, why does the image seem to leave traces as it moves?	Condition due to the liquid crystals.	Not a malfunction. Spots that appear in the LCD monitor only appear in the monitor and will not be recorded with the images.
	Why does the displayed image contain some red, blue and green dots, or black spots are visible?		
Viewing images	Why is the image too bright?	The subject was too bright.	When capturing an image, devise a way to compensate for a bright subject, for example, by changing the shooting angle.
	Why is the image out of focus?	The focus is not locked properly.	Hold the digital camera correctly and slowly press the shutter release button halfway to lock the focus. Then press the shutter release button all the way to capture the image.

	Question	Answer	Action
Viewing images	Why is a part of the image missing?	The image was captured at close range.	When capturing an image at close range, use the close-up alignment correction marks or compose the image using the LCD monitor.
	Why is there no image (■ is shown)?	This may happen when trying to play back images stored on a card from a different digital camera.	Play back images stored on a card using this digital camera.
	Why do vertical stripes appear?	If a bright subject is shot in the video clip shooting mode, vertical stripes may appear on the LCD monitor or in the image.	Not a malfunction.
	Why isn't the magnified image clear?	Due to the characteristics of the camera, magnified images appear less clear.	Not a malfunction.
	Why isn't the captured image clear?	The image was captured using the digital zoom.	Not a malfunction.
	Can I play back image data that I edited using my computer?	—	We cannot guarantee the accurate playback of data that has been edited using a computer.
	Why is there no sound when a video clip is played back?	This digital camera does not have audio record or playback functions.	Not a malfunction.

COMMONLY ASKED QUESTIONS

	Question	Answer	Action
Printing	Why does a message appear during PictBridge printing?	Printer error.	Please refer to the instruction manual for your printer.
Misc.	Why does the "CARD IS PROTECTED" message appear?	The write-protect tab on the card is in the locked (protect) position.	Move the write-protect tab to the unlocked position.
	Why are there some menus or icons that I can't select?	Another setting has priority.	Change the other setting.
	Why can't the digital camera be operated?	A temporary internal circuitry problem may be the cause.	Remove the batteries from the digital camera, wait a few minutes, then reinstall the batteries and try again.

	Question	Answer	Action
Misc.	Why does the "SYSTEM ERROR" message appear?	A problem has occurred within the digital camera or card.	<p>Check the following items</p> <p>① Remove the card and then install it again. Misc.</p> <p>② Remove the batteries and then install them again.</p> <p>③ Install a different card.</p> <p>If "SYSTEM ERROR" still appears after performing the above steps, then take the digital camera to the dealer for service.</p>



TROUBLESHOOTING

Before taking your camera to the repair shop, check the following table for a possible solution to the problem.

	Problem	Cause	Action	Reference page
Power	No power.	The batteries are dead.	Replace with new batteries.	21
		The batteries have not been inserted correctly.	Reinsert the batteries, making sure to orient them correctly.	
		The battery compartment cover is not fully closed.	Close battery compartment cover properly.	
	The digital camera turns off by itself.	The power save function is operating.	Turn on the camera again.	24
Shooting	An image is not captured when the shutter release button is pressed.	The power is not turned on.	Turn on the power.	23

	Problem	Cause	Action	Reference page
Shooting	The flash does not operate.	The flash off mode is selected.	Set the flash to automatic flash mode or forced flash mode.	34
		The shooting mode is set to a mode other than the still image shooting mode.	Set the camera to the still image shooting mode.	29
		The batteries are dead.	Replace with new batteries.	21
	The accessing indicator flashes, and self-timer photography is not possible.	The batteries are consumed.	Replace with new batteries.	21

TROUBLESHOOTING

	Problem	Cause	Action	Reference page
Shooting	Zoom operation stops midway.	The optical zoom has moved to the maximum magnification position.	Not a malfunction. Release the zoom switch, and press it again.	36
	The motion alert icon  is shown on the LCD display.	The shutter speed is slow.	Stabilize the camera with a tripod or the like.	31
LCD monitor	When capturing an image, no image is displayed on the LCD monitor.	The LCD monitor has been disabled.	Change the setting to enable to LCD monitor.	83
	No playback image appears.	The main switch is not set to [].	Set the main switch to [].	56

	Problem	Cause	Action	Reference page
Viewing images	The image is too dark.	The flash was blocked by a finger or other object.	Hold the digital camera correctly, and make sure the flash is not obstructed.	25
		The subject was too far away.	Capture the image in the range of operation of the flash.	130
		The subject was lit from behind.	Capture the image using the forced flash mode.	34
	The image is too bright.	The forced flash mode is selected.	Select a different flash mode.	34
		The subject was too bright.	Use the exposure correction function.	55

TROUBLESHOOTING

	Problem	Cause	Action	Reference page
Viewing images	The image is not in focus.	The subject is too close to the digital camera.	Select the correct focus setting for your needs.	52
		The focus setting is not correct.		
		The digital camera moved when the shutter was released.	Hold the digital camera correctly and slowly press the shutter release button halfway to lock the focus. Then press the shutter release button all the way to capture the image.	25, 30
		The focus is not locked properly.		
The lens is dirty.	Clean the lens.	14		

	Problem	Cause	Action	Reference page
Viewing images	The colors of the images captured indoors are not correct.	This is due to ambient lighting.	Capture the image using the forced flash mode.	34
		The white balance setting is incorrect.	Set the white balance setting correctly.	54
	A part of the image is missing.	The handstrap or a finger was blocking the lens.	Hold the digital camera correctly, and make sure the lens is not obstructed.	25
	"NO IMAGE" is shown.	There is no recorded data.	Playback data after capturing images.	—
Image editing	You cannot rotate an image.	The protect mode is set.	Cancel the protect mode.	67
	The "CAN NOT RESIZE" message appears.	The resolution is 320 × 240 pixels ([320]).	Resize is not possible. Select an image with a resolution of 640 × 480 pixels ([WEB]) or higher.	63

TROUBLESHOOTING





	Problem	Cause	Action	Reference page
Misc.	The "IMAGE IS PROTECTED" message appears and the data cannot be erased.	You have attempted to erase data that is protected from accidental erasure.	Set the protect setting for the data to OFF.	67
	"CARD FULL" or "INTERNAL MEMORY FULL" message appears.	There is no more available memory on the card or in the internal memory.	If using a card to store images, replace with a different card.	22
			Erase unwanted images before shooting.	69
			Save the images you wish to keep on another medium before erasing the card memory.	71

SPECIFICATIONS

Digital Camera

Type	CCD digital camera (recording and playback)
Recording system	Digital recording
Image file format	Still images: JPEG format (DCF, DPOF, Exif 2.2 compliant) Note: Designed mainly by the Japan Electronics and Information Technology Industries Association (JEITA), DCF (Design rules for camera file system) is standard for digital still camera image files to provide interoperability between digital photography devices for the images stored on removable memory cards. However, it is not guaranteed that all devices will support the DCF standard. Video clips: QuickTime Movie (Photo-JPEG) (Image only: no voice recording capability)
Data storage media	Internal memory: 16MB External memory: SD Memory Card, Multi Media card
Camera effective number of pixels	Approx. 5,100,000 pixels
Image sensor	1/2.5-inch CCD Total number of pixels: Approx. 5,360,000 pixels, interlace scan, primary color filter
Recording resolution	3,680 × 2,760 pixels : 10M (still images only) 2,592 × 1,944 pixels : 5M (still images and sequential shots only) 1,600 × 1,200 pixels : 2M (still images and sequential shots only) 640 × 480 pixels : WEB (still images and sequential shots only) 320 × 240 pixels : 320 (video clips only) 160 × 120 pixels : 160 (video clips only)
Video clip frame rate	15 fps

SPECIFICATIONS

Data compression	Still images and sequential shots only Low compression:  Normal compression: 	
White balance	Full-auto TTL, manual setting possible	
Lens	Optical 2.8x zoom lens	f=6.2 mm to 17.4 mm (35 mm film camera conversion f=37 mm to 105 mm) Autofocus, 6 groups, 7 elements
Focus modes	TTL-type AF(5-point range autofocus)	
Aperture	Open F=3.0 (Wide) to 5.0 (Tele) Smallest F=4.1 (Wide) to 7.1 (Tele)	
Exposure control type	Programmable AE Exposure correction available from the Shooting Setting Screen (0±1.8EV in 0.3EV steps)	
Light-measuring mode	Multi-section measuring	
Range	50 cm (19.69 in) (Wide)/50 cm (19.69 in) (Tele) to infinity (normal photography), 2 cm (0.79 in) (Wide)/50 cm (19.69 in) (Tele) to 50 cm (19.69 in) (super macro photography)	
Digital zoom	For shooting: 1x to 4x For playback: 1x to Approx. 58x (varies with resolution)	
Shutter speed	Still image shooting mode: 1/2 to 1/2,000 sec. (Maximum approx. 2 seconds when scene select function Night view  , landscape ) (During flash: 1/30 to 1/2,000 sec.) Sequential shots shooting mode: 1/2 to 1/2,000 sec. Video clip shooting mode: 1/30 to 1/10,000 sec.	

Sensitivity		Still image shooting mode/sequential shots shooting mode: Auto (equivalent to ISO50 to 200) Video clip shooting mode: Auto (equivalent to ISO100 to 400)
Viewfinder		Optical direct image zoom viewfinder
LCD monitor		1.8-inch TFT color liquid crystal Approx. 85,000 pixels (Frame coverage: Approx. 100%)
Flash working range		0.15 m to 2.8 m (0.49 to 9.19 ft.) (Wide) 0.5 m to 1.7 m (1.64 to 5.58 ft.) (Tele)
Flash modes		Auto-flash, forced flash, flash off, red-eye reduction
Self-timer		2-second delay, 10-second delay
Time/date		Recorded with image data
Ambient environment	Temperature	0 to 40°C (32 to 104°F) (operation), -20 to 60°C (-4 to 140°F) (storage)
	Humidity	30 to 90% (operating, no condensation) 10 to 90% (storage, no condensation)
Power supply	Batteries	AA-size alkaline batteries × 2 The following batteries can also be used: AA-size Ni-Cd batteries (SANYO N-3UV) × 2 AA-size nickel metal hydride batteries (SANYO HR-3UF) × 2 Lithium battery (CR-V3) × 1 * AA-size manganese batteries cannot be used.
	AC adapter (sold separately)	model VAR-G4AEX for Europe, U.K. and others, and model VAR-G4AU for North America and others
Dimensions (not including protuberances, depth at narrowest dimension)		91.3 (W) × 61.5 (H) × 30.8 (D) mm 3.59" (W) × 2.42" (H) × 1.21" (D)
Weight		Approx. 140 g (4.94 oz) (without batteries and card)

SPECIFICATIONS

Camera Connector

OUTPUT terminal	USB 2.0 (In full speed mode: equivalent to 1.1)
DC IN (external DC power input) terminal	DC 3.4 V (for exclusive use with the separately sold AC adapter (model VAR-G4AEX for Europe, U.K. and others, and model VAR-G4AU for North America and others))

Battery operation

	Alkaline batteries (supplied)	Lithium battery (sold separately: CR-V3)	Nickel metal hydride batteries (sold separately: HR-3UF)
Possible No. of Images*	110 images	600 images	400 images
Maximum playback time**	300 min.	680 min.	470 min.

* According to the CIPA standard (Matsushita Electric Industrial Co., Ltd. 64MB SD Memory Card use).

** With continuous playback when using the LCD monitor.

NOTE

- The battery life may differ depending on the state of the batteries and the measurement conditions, especially when used at temperatures below 10°C (50°F), the battery life may become extremely short due to the battery characteristics.

Possible No. of Images/Possible Shooting Time

Shooting/recording mode	Resolution setting	Compression rate setting	When using the internal memory	When using an external memory	
				128MB	1GB*
Still image mode (no voice memo)/ Sequential shots mode	10M	FINE	4 images	37 images	297 images
		NORM	7 images	56 images	445 images
	5M	FINE	9 images	75 images	595 images
		NORM	14 images	111 images	885 images
	2M	FINE	24 images	191 images	1,510 images
		NORM	36 images	290 images	2,290 images
	WEB	FINE	124 images	979 images	7,740 images
		NORM	166 images	1,300 images	10,320 images
Video clip mode	320	—	50 sec.	6 min. 37 sec.	52 min. 27sec.
	160	—	2 min. 56 sec.	23 min. 11 sec.	3 hr. 3 min.

- Even with cards of the same capacity, the amount of data that can actually be stored may differ depending on the card brand, etc.
- The continuous shooting time for each video clip will differ depending, for example, on the card capacity, environmental conditions (temperature and shooting conditions, etc.).

* SanDisk Corporation 1GB SD Memory Card use.

SPECIFICATIONS

Others

Apple, Macintosh and QuickTime are trademarks or registered trademarks of Apple Computer Inc.

Windows and Windows NT are registered trademarks of Microsoft Corporation.

All other company and product names are registered trademarks or trademarks of their respective owners.

Caution

- It is forbidden to copy this manual, whole or in part, without prior written permission.
- All images and illustrations given in this manual are for explanation purposes and may differ slightly from that of the actual product. Also, actual specifications are subject to change without prior notice and therefore may differ from the contents of this manual.
- Sanyo Electric shall not be held responsible for any problems resulting from the use of this digital camera.
- Sanyo Electric declines all responsibility for damages due to improper use of the camera, failure to adhere to the instructions given in this manual, or repairs or changes done by those other than a technician authorized by the manufacturer.
- Sanyo Electric shall not be held responsible for any damage caused by optional devices or consumable items used with the digital camera other than those supplied with the digital camera or those specified by Sanyo Electric.
- Sanyo Electric shall not be held responsible for any losses or loss of revenue resulting from the loss of data caused by the malfunction, or the repairing of a malfunction, of the digital camera.
- The images captured with this camera will differ in quality from pictures taken with a standard film camera.
- Products are subject to change in design and specifications without notice and without incurring any obligation.

HINTS FOR TAKING PICTURES

Taking great pictures in difficult surroundings is easier than you might think. By keeping a few points in mind and choosing the correct settings, you can create photos that you'll be proud to display and share.

If images are blurred even when the autofocus is used

Your camera employs an autofocus function. When you snap a picture using the autofocus, the camera automatically adjusts the settings so that the image will be in focus. If you are getting blurred images even when using the autofocus, one or more of the following might be the reason.

■ How the autofocus works

The autofocus is activated when the shutter release button is gently pressed halfway. Press the shutter release button slightly, and the target mark will appear on the LCD monitor to indicate that the autofocus has been activated. Next, continue to gently press the shutter release button all the way to snap the picture. This two-step method is the way to ensure that your photos are perfectly focussed.

■ Reasons for unfocussed images

- ① The shutter release button was pressed all the way in one step.
- ② After the image was focussed, the subject moved.
 - Even if camera focusses the subject once, if the distance between the camera and the subject is changed, the subject may become out of focus.
- ③ The focus setting is not set for the correct distance.
 - If you shoot a close-up subject with the camera set to the normal focus mode, or if you shoot a subject at normal distance with the camera set to the super macro (close-up) mode, the image will not be in focus.

■ Preventing blurred images

- ① Confirm that the camera is set to the correct focus mode for your subject.
- ② Hold the camera correctly, and press the shutter release button halfway.
- ③ Wait for the target mark to appear in the LCD monitor, and holding the camera steady, gently continue to press the shutter release button all the way down.

Following these steps for a gentle but firm pressing of the shutter release button will ensure that you get beautifully focussed photos.

Photographing a moving subject

Situation: You would like to snap an action shot of a moving child or pet. The autofocus is activated, but because the subject is moving, the image may be blurred. In particular, when the distance between the camera and the subject is changing, it is difficult to lock the focus on the subject. Here are some hints for successfully capturing images of moving subjects.

■ Reasons for unfocussed images

When the shutter release button is gently pressed halfway, the camera's autofocus works by determining the distance between the camera and the subject. Once the subject is in focus, if it then moves before the picture is

HINTS FOR TAKING PICTURES

Shooting portraits (portrait mode)

Points:

- Choose a background that doesn't detract from your subject.
- Move in close to your subject.
- Pay attention to lighting and how it affects your subject.

NOTE

- If the background is distracting, it will not show your subject to his best advantage. Move in closer to your subject or zoom in so that the background does not compete with the subject.
- In portrait photography your subject is clearly the central figure, so try techniques that allow the subject to stand out.
- If light is coming from behind your subject (backlit), his face will appear dark. You can get a better picture by using the flash, for example, or changing the exposure setting.

Photographing moving subjects (sports mode)

Points:

- Match the camera's movement with that of the subject.
- Set the zoom to the Wide end (wide-angle).
- Don't be too hesitant to press the shutter release button, or you'll miss the action.

NOTE

- Tips to not missing those great action shots: Make sure you're holding the camera correctly. Keep the subject in the lens at all times, moving the camera with him while waiting for the right shot. Move your whole body—not just your arms—with the camera while shooting.
- Blurred images are more likely when the zoom is set to the Tele end than the Wide end. Set the zoom as close as possible to the Wide end.
- Learn to press the shutter release button quickly yet smoothly the instant your photo chance occurs.

Night photography (night view mode)

Points:

- Avoid camera shake.
- Adjust the exposure.

NOTE

- Camera shutter speed during night photography is considerably slower, so there is a much greater chance that your photographed images will be blurry. Use a tripod whenever possible, or if a tripod is not available, you can lean against a wall or pillar to help stabilize the camera.
- You can photograph your subject with the night scene in the background by using the flash. Be careful not to shoot too close to the subject, however, or your subject's face will appear too bright.
- After the flash operates, keep the camera and the subjects motionless for about 1 second.

Photographing scenery (landscape mode)

Points:

- Shoot using a high resolution.
- For zoom photography, use the optical zoom.
- Pay attention to picture composition.

NOTE

- When shooting with a wide-angle setting, or if you intend to enlarge the photo, the higher the resolution, the better.
- To zoom in on distant scenery, it's better to use the optical zoom. Using the digital zoom produces a coarser image. Hold the camera securely, keeping your elbows close to your body and making sure the camera is stable. Using a tripod or other means of stabilizing the camera will increase the likelihood of getting a clear photo.
- Don't forget to pay attention to picture composition; note perspective and be aware of how the placement of objects affects the scene.

SANYO

SANYO Electric Co., Ltd.

Free Manuals Download Website

<http://myh66.com>

<http://usermanuals.us>

<http://www.somanuals.com>

<http://www.4manuals.cc>

<http://www.manual-lib.com>

<http://www.404manual.com>

<http://www.luxmanual.com>

<http://aubethermostatmanual.com>

Golf course search by state

<http://golfingnear.com>

Email search by domain

<http://emailbydomain.com>

Auto manuals search

<http://auto.somanuals.com>

TV manuals search

<http://tv.somanuals.com>