



VPC-SX560EX
VPC-SX560E
VPC-SX560

INSTRUCTION MANUAL
Digital Camera

English

MANUEL D'INSTRUCTIONS
Appareil photo numérique

Français

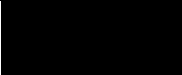

Warning

TO PREVENT THE RISK OF FIRE OR ELECTRIC SHOCK, DO NOT EXPOSE THIS APPLIANCE TO RAIN OR MOISTURE

FOR AMERICAN USERS

- This equipment has been tested and found to comply with the limits for a Class B digital device, pursuant to Part 15 of the FCC Rules. These limits are designed to provide reasonable protection against harmful interference in a residential installation. This equipment generates, uses and can radiate radio frequency energy and, if not installed and used in accordance with the instructions, may cause harmful interference to radio communications. However, there is no guarantee that interference will not occur in a particular installation. If this equipment does cause harmful interference to radio or television reception, which can be determined by turning the equipment off and on, the user is encouraged to try to correct the interference by one or more of the following measures:
 - Reorient or relocate the receiving antenna.
 - Increase the separation between the equipment and receiver.
 - Connect the equipment into an outlet on a circuit different from that to which the receiver is connected.
 - Consult the dealer or an experienced radio/TV technician for help.
- Changes or modifications not expressly approved by the party responsible for compliance could void the user's authority to operate the equipment.



Tested To Comply With FCC Standards

FOR HOME OR OFFICE USE

Declaration of Conformity

Model Number : VPC-SX560
Trade Name : SANYO
Responsible party : SANYO FISHER COMPANY
Address : 21605 Plummer Street, Chatsworth, California 91311
Telephone No. : (818) 998-7322

This device complies with Part 15 of the FCC Rules. Operation is subject to the following two conditions:

- (1) this device may not cause harmful interference, and
- (2) this device must accept any interference received, including interference that may cause undesired operation.

FOR CANADIAN USERS

- This Class B digital apparatus complies with Canadian ICES-003.

BEFORE READING THE MANUAL

Microdrive, IBM PC, PowerPC and IBM are registered trademarks of International Business Machines Corporation.

Apple, Macintosh and QuickTime are registered trademarks of Apple Computer Inc.

Windows and Windows NT are registered trademarks of Microsoft Corporation.

CompactFlash is a trademark of SanDisk Corporation and handed over to CFA (CompactFlash Association).

All other company and product names are registered trademarks or trademarks of their respective owners.

Regarding the data storage media

- This digital camera can use both CompactFlash and Microdrive cards for data storage. This

CONTENTS

USING YOUR DIGITAL CAMERA SAFELY AND CORRECTLY	3
CHECKING THE INCLUDED ACCESSORIES	13
PREPARATION	
USING THE HAND-STRAP AND SOFT CASE	14
QUICK START FOR CAPTURING IMAGES	15
PARTS NAMES	19
PREPARATION OF BATTERIES	21
INSTALLING AND REMOVING THE CARDS	25
TURNING THE POWER ON/OFF	27
DISPLAYING THE SETTING SCREEN AND OPTION SETTING SCREEN	29
SHOOTING SETTING SCREENS	31
PLAYBACK SETTING SCREEN	35
OPTION SETTING SCREEN	36
INFORMATION DISPLAY (info BUTTON)	37
SETTING SCREEN BASIC OPERATIONS	40
SETTING THE DATE AND TIME	41
REMAINING BATTERY CHARGE INDICATION	44
CHECKING THE REMAINING NUMBER OF IMAGES, VIDEO RECORDING TIME, AND AUDIO RECORDING TIME	46
CONCERNING IMAGE AND AUDIO DATA STORAGE	48
SHOOTING AND RECORDING	
SETTING THE SHOOTING MODE	50
SETTING THE RESOLUTION	51
SETTING THE COMPRESSION RATIO	53
EXPLANATION OF AUTO AND MANUAL SHOOTING MODES	54
CAPTURING IMAGES	56
SEQUENTIAL SHOT	58
VIDEO CLIP	64
USING THE AUTOFOCUS	66
USING THE VARIOUS SHOOTING FUNCTIONS	67
MANUAL MODE SETTINGS	75
PERFORMING AN AUDIO RECORDING	81
PLAYBACK DATA	
SETTING THE PLAYBACK MODE	83
PLAYING BACK STILL IMAGES	85
PLAYING BACK SEQUENTIAL SHOTS	88
PLAYING BACK VIDEO CLIPS	89
ENLARGING (ZOOMING IN) THE IMAGE	91
LISTENING TO AUDIO RECORDINGS	92
OTHER FUNCTIONS	
PLAYING BACK IMAGES ON A TV SET	94
COMPOSITION IMAGE (ADD PHOTO FUNCTION)	95
ADDING A VOICE MEMO (ADD AUDIO FUNCTION)	99
ENTERING TEXT	101
EDITING VIDEO CLIPS (CLIPPING/JOINT FUNCTION)	104
IMAGE PROTECT MODE (PREVENTING ACCIDENTAL ERASURE)	109
ERASING DATA	110
COPYING IMAGES	112
REQUESTING PRINTING	113
ABOUT THE ROULETTE GAME OPTION	117
REFORMATTING THE CARD	122
DISCHARGING THE BATTERIES	124
CHANGING THE DISPLAY LANGUAGE	125
USING THE CAMERA WITH A COMPUTER	126
APPENDICES	
TROUBLESHOOTING	127
SPECIFICATIONS	131

USING YOUR DIGITAL CAMERA SAFELY AND CORRECTLY

WARNING

Concerning the Digital Camera

■ **Do not use the digital camera if it makes a strange noise, emits a strange odor, or if smoke comes out from it**

- If the digital camera is used under these conditions, it may cause a fire or electric shock. Immediately turn off the digital camera, remove the batteries, and wait to make sure no more smoke comes from the digital camera. Then take it to the dealer for service. Do not try to repair or open the digital camera yourself.



■ **Do not modify or open the cabinet**

- High voltage circuits are inside, and there is a high risk of fire or electric shock if they are touched. Any internal check, setting, or repair should be performed by the dealer.



■ **Do not use while driving**

- Do not capture images, play back images, or watch the LCD monitor while driving a vehicle. Doing so may cause an accident.
- Be careful where you put down the digital camera inside an automobile. During sudden stops or turns it may fall behind the brake pedal and prevent braking.
- When using the digital camera while walking, be very careful of your surroundings and especially the traffic to avoid accidents.



■ **Be aware of your surroundings when using the digital camera**

- Pay close attention to your surroundings when using the digital camera. Failure to do so may lead to an accident or injury.
- Do not use the digital camera inside an airplane or elsewhere where its use may be restricted.



■ **Do not get the digital camera wet**

- This digital camera is not water-resistant. Do not allow it to get wet for it may cause a fire or electric shock.
- Do not use the digital camera in a bathroom.
- If the digital camera gets wet, immediately turn it off and remove the batteries. Then take it to the dealer for repair. Using the digital camera after it has become wet may cause a fire, electric shock, or other accident.

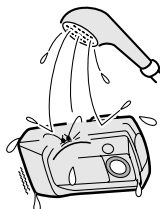

WARNING

■ Do not use during a storm

- To avoid the risk of being struck by lightning, do not use the digital camera during a thunderstorm. In particular, if used in an open field, you have an increased chance of being struck by lightning. Quickly seek refuge in a place that will protect you from lightning.



■ Do not place on an unstable surface

- The digital camera may fall, resulting in damage to the digital camera or injury.
- If the digital camera has fallen and its body is damaged, turn off the digital camera, remove the batteries, and take it to the dealer for repair. Using the digital camera after its body has been damaged may cause a fire or electric shock.



■ Do not look through the digital camera into the sun

- Do not look through the digital camera at the sun or any other strong source of light. Doing so may seriously injure your eyes.

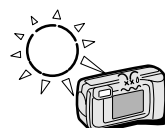

■ Do not use the flash close to a person's face

- To prevent possible eye injury, do not use the flash near a person's face (especially young children or babies). If the flash is used close to a person's opened eyes, there is a risk that it may damage that person's eyesight.

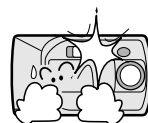

■ Do not use where there is risk of explosion

- Do not use the digital camera in a location where there is explosive gas, or any other flammable material in the air. Doing so may cause a fire or an explosion.



■ Keep the digital camera out of the reach of children

- The following may happen if children play with the digital camera:
 - They may wrap the strap around their neck and suffocate.
 - They may swallow the batteries or other small parts. In such a case, consult a physician immediately.
 - They may damage their eyesight if the flash goes off too close to their eyes.
 - They may get hurt by the digital camera.

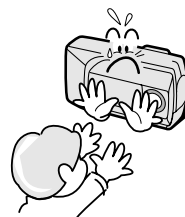

WARNING

■ Concerning the Batteries

Concerning the supplied nickel metal hydride batteries

- Follow all the warnings indicated below to prevent the batteries from leaking, overheating, exploding, catching fire, or becoming damaged.
 - Use only the supplied battery charger for recharging.
 - Do not install with the polarities ((+) and (-)) inverted.
 - Do not heat the batteries or throw them in a fire.
 - Do not allow metal objects to touch the terminals. Do not carry loose with necklaces, hairpins, etc.
 - Do not transform, open, or modify.
 - Do not put in water or any liquid, or get the terminals wet.
 - Always stop the recharging after the prescribed recharge time, even if the batteries are not fully charged.
- Operating and storage conditions
 - Do not remove or puncture the external wrapping.
 - Do not use if there is leaking, swelling, temperature rising, discoloration, or any other abnormal condition.
 - Keep out of the reach of children.
 - Do not drop, hit, or submit the batteries to strong shocks.
 - Do not use recharged batteries together with discharged batteries.
 - Recharge and use two batteries at a time.
 - Always recharge the batteries before using them for the first time, or when using them after they have been kept in storage for a long time.

● Temperature	0 to 40°C (charged) 0 to 50°C (discharged) -20 to 30°C (storage)	● Humidity	45 to 85%
---------------	--	------------	-----------

General precautions

- Use the nickel metal hydride batteries supplied with the digital camera. Manganese batteries cannot be used, as they have a short battery life and may overheat, causing damage to the digital camera.
 - Do not use a recharged battery together with a discharged battery. Do not use nickel metal hydride batteries together with Ni-Cd batteries, or batteries of different types or different brands at the same time.
 - Make sure not to invert the polarity ((+) and (-)) when installing the batteries. Install the batteries as described by the indicated polarity.
 - Use of different types or brands of batteries at the same time may generate heat or cause the batteries to leak, resulting in fire, injury or burns, or damage to the digital camera and any other nearby object.
 - Use only batteries from well-known manufacturers. Use of batteries without protective casings or other inferior products may cause a fire, injury, or burns.
-
- The batteries may be warm immediately after the digital camera is used. If removing the batteries, turn off the digital camera and allow for the batteries to cool down before removing them.
 - If a battery is leaking and the electrolyte gets on your skin or clothing, immediately rinse with clean water. If the electrolyte gets into your eyes, you risk losing your eyesight. Immediately rinse your eyes with clean, running water, and seek medical attention right away.
 - Do not drop or hit the batteries, or submit them to strong shocks.
 - If the digital camera is not going to be used for a long period of time, remove the batteries and store them in a cool place. (When the batteries are removed for a long period, the time and date settings will be cleared.)
 - When disposing of the batteries, make sure to follow all applicable regulations.
 - If used in temperature below 10°C, the service life of the batteries will be shorter than normal.
 - Always read the instruction manuals that may come with the batteries you purchase before use.

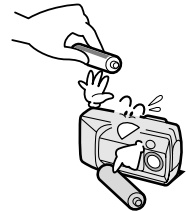

WARNING

Concerning the Supplied Battery Charger

Warning! Do not attempt to recharge non-rechargeable batteries.

For indoor use only.

The appliance is not intended for use by young children or infirm persons without supervision.

Young children should be supervised to ensure that they do not play with the appliance.

■ Do not use the battery charger if it makes strange noises, emits strange odors, or smoke

- If the battery charger is used under these conditions, it may cause a fire or electric shock.
- If strange conditions such as these occur, immediately unplug the battery charger, remove the batteries, and wait to make sure no more smoke is emitted. Then contact the place of purchase. Do not try to repair or open the battery charger yourself.



■ Do not damage the power cord

- Do not place heavy objects on the power cord. Do not place the power cord near a heat source. Do not excessively bend the power cord, modify it, or secure it with staples. Doing so may damage the power cord and cause a fire or electric shock.
- If the power cord is damaged, or if it does not plug properly into the battery charger or wall outlet, contact the place of purchase.



■ Cautions concerning the power cord

- Do not leave the power cord plugged into the power outlet while the other end is not plugged into the battery charger. The loose end can cause electrocution if touched with wet hands or if handled by children.
- Only use the power cord supplied with the battery charger. If a different power cord is used, it may be rated for a different current load, and that may cause a fire.
- The supplied power cord is for exclusive use with the supplied battery charger. Do not use it with other devices for it may cause a fire or electric shock.

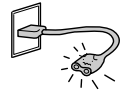

■ Cautions when plugging in the battery charger

- Securely plug the power cord all the way in the power outlet when using the battery charger. If the battery charger is used with the power cord not fully plugged in, heat may generate and cause a fire.
- If the power cord is damaged, or cannot be correctly plugged into the power outlet, do not use the battery charger. Using the battery charger in this condition may cause a fire or electric shock.
- Do not allow dust, etc., to build up on the power cord or power outlet. A build-up of dust may cause a short circuit or generate heat and cause a fire.



■ Do not pull on power cord to unplug it

- When unplugging the power cord, be sure to hold the power plug and slowly pull it out of the power outlet. Pulling the cord portion may damage the power cord and cause a fire or electric shock.



■ Use a 100 to 240 V AC power supply

- If used with a power supply other than that specified, it may cause a fire or electric shock.



■ Keep the battery charger out of the reach of children

- Children may place the batteries or other small components in their mouth or perform some other such unforeseeable action. If swallowed, consult a physician immediately.



■ Use with the nickel metal hydride or Ni-Cd batteries

- Do not use the supplied battery charger to recharge batteries other than the rechargeable nickel metal hydride batteries (HR-3US or HR-3U, supplied with the digital camera or sold separately) or Ni-Cd batteries (N-3US or N-3U, sold separately). Recharging a dry-cell battery or other type of rechargeable battery may cause excess heat, combustion, or leakage, and cause a fire, injuries, burns, or damage to nearby objects.



■ Do not invert the polarity ((+) and (-)) of the batteries

- Place the batteries in the battery charger with the (+) and (-) terminals oriented as indicated on the charger. If the batteries are placed in the wrong orientation, the batteries may leak, overheat, explode, or be damaged.



■ Unplug the power cord from the power outlet when finished

- If the battery charger is left plugged into the power outlet for a long period of time, there is a risk of fire. In particular, if the batteries are recharged continuously for more than two days (48 hours), they may generate heat, leak, or explode.



■ Do not disassemble or modify the battery charger

- It is dangerous to touch the inside of the battery charger. Doing so may cause a fire or electric shock.
- Do not use the battery charger as a direct current generator.



■ Do not get the battery charger wet

- Make sure the battery charger does not get wet, for it may cause a fire or electric shock.
- Do not use the battery charger in a bathroom.
- If the battery charger gets wet, immediately unplug it from the power outlet and remove the batteries. Then contact the place of purchase. If used while wet, it may cause a fire, electric shock, or an accident.



■ Do not handle with wet hands

- Handling the battery charger with wet hands may cause an electric shock.



■ Do not use during a storm

- Do not touch the battery charger or power cord while it is plugged into a power outlet during a thunderstorm. Doing so may cause an electric shock.



■ Do not place on an unstable surface

- It may fall down, causing injury or damage.
- If the battery falls down and the charger body is damaged, remove the batteries and contact the place of purchase. If used while damaged, it may cause a fire, electric shock, or other damages.



■ Operating and storage conditions

- Do not use close to a heat source (close to a stove or heater) or exposed to direct sunlight.

● Temperature	5 to 35°C (charging)	● Humidity	45 to 85%
	-20 to 60°C (storage)		(charging and storage)

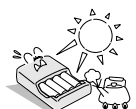

CAUTION

Concerning the Digital Camera

■ Cautions when carrying the digital camera

- Do not walk around holding the digital camera by the hand-strap. It may hit other objects and get damaged. When walking around, hold the digital camera in your hand or place it in a pocket.
- Be careful not to drop the digital camera or subject it to strong shocks.
- Make sure direct sunlight does not hit the digital camera lens, as that may damage the internal parts. When not using the digital camera, be sure to always keep the lens cover closed.

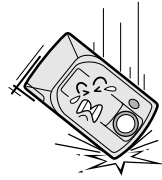

■ Cautions during use and storage

- This digital camera is a precision instrument. When using or storing the digital camera, make sure to avoid the following locations to avoid damages.
 - Places in direct sunlight
 - Places where humidity and temperature are high
 - Places that may get wet
 - Places close to an air conditioner or heater
 - Inside a car
 - Places where there is dust and dirt
 - Places where there is a fire burning
 - Places where volatile products are stored
 - Places subject to vibrations

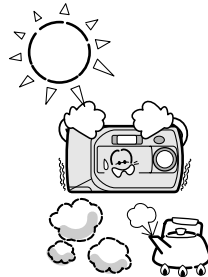

• Temperature 0 to 40°C (operation)	• Humidity 30 to 90% (operation, no condensation)
-20 to 60°C (storage)	10 to 90% (storage, no condensation)

■ Cautions if the digital camera is not going to be used for a long period

- For safety, remove the batteries. The batteries may generate heat or leak, and that may start a fire, cause injuries or burns, and damage the digital camera and any other objects placed nearby. (When the batteries are removed for a long period, the time and date settings will be cleared.)

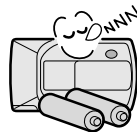

Concerning the Accessories

■ Cautions concerning the use of the AC adaptor

- Use only the specified AC adaptor (model VAR-G4EX for the VPC-SX560EX, model VAR-G4E for the VPC-SX560E and model VAR-G4U for the VPC-SX560) with your digital camera. Do not use an AC adaptor other than the one indicated here, designed for specific use with your digital camera.
- If an AC adaptor other than the specified one is used, it may damage the digital camera and cause a fire or electric shock.
- For complete information on how to use the AC adaptor, refer to the instructions accompanying the AC adaptor.

■ Cautions concerning the CompactFlash and Microdrive

- Immediately after use, the CompactFlash and Microdrive will be very hot. Before removing the CompactFlash or Microdrive, turn off the digital camera and wait for the temperature to cool down.
- Keep out of the reach of children. Young children may put the media in their mouth and choke or cause some other unexpected injury or accident.

■ Cautions before capturing important images

- Before capturing important images, make sure that the digital camera is operating properly and in condition to capture the image properly.
- Sanyo Electric shall not be held responsible for any losses that result from images that could not be recorded, are erased, destroyed, or damaged in any way due to a problem with the digital camera, any of its accessories, or its software.

■ Cautions concerning copyrights

- The images you capture with your digital camera are for your own private use, any other use may violate the rights of copyrights owners.

■ Cautions when cleaning the digital camera

- Do not use benzene or thinner products to clean the digital camera. Doing so may cause deformation, discoloration, or paint peeling. When using a chemically treated cloth, carefully read its instructions and warnings.
- Do not spray insecticides, or volatile sprays on the digital camera. Do not leave rubber or vinyl objects against the digital camera for a long period. They may cause deformation, discoloration, or paint peeling.

Cleaning procedure

- 1 Turn off the digital camera and remove the batteries.
- 2 Remove the dirt with a soft cloth.
- 3 If the digital camera is extremely dirty, wipe with a soft cloth moistened with a mild detergent diluted with water and wrung dry.

■ Cautions concerning the nickel metal hydride batteries

- Periodically clean with a dry cloth the terminals of the nickel metal hydride batteries ((+) and (-)) and the terminals located in the battery compartment of the digital camera.
- Do not touch the battery terminals or the terminals in the battery compartment of the digital camera with your bare hands. Doing so will allow contaminants from your hands to adhere to the terminals and oxidize, increasing the contact resistance. If the contact resistance increases, the usable life of the batteries will diminish.

CAUTION

■ Cautions when cleaning the lens

- If the lens gets dirty, use a commercially available air blower or a cleaning cloth for photographic equipment to clean it.

■ Cautions when not using the digital camera

- Close the lens cover whenever you are not using the digital camera.

■ When not using the digital camera for a long period

- Remove the batteries. However, when the batteries are removed for a long time, the digital camera functions may begin to not work properly. Periodically reinstall the batteries and check the digital camera functions.
- If the batteries are left in the digital camera, a small amount of power is still used even if the digital camera is turned off. If the nickel metal hydride batteries are left in the digital camera for a long period, they may become completely discharged and lose their ability to be recharged again.

■ Cautions concerning condensation

- Using the digital camera with condensation inside it may damage the digital camera.

Be careful of condensation under the following conditions

- When moving the digital camera suddenly from a cold place to a warm place.
- When the ambient temperature changes drastically, such as when a heater is turned on to quickly heat the room.
- When the digital camera is placed in the path of cool air from an air conditioner.
- When the digital camera is placed in a location of high humidity.

If condensation seems likely to form

- Place the digital camera in a plastic bag and seal it, and then wait until the digital camera has reached the ambient temperature.

■ Cautions concerning undesired interference

- The digital camera may create undesired interference if used close to a television or radio. To avoid this type of interference, make sure the cores on the supplied AV cable and computer serial port interface cable are not removed.

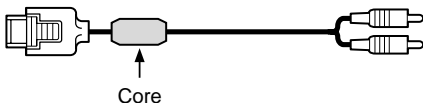

■ Cautions concerning magnetism

- Do not place credit cards, bank cards, floppy disks, or other items that may be damaged by magnetic fields near the speaker. Data may be lost or the magnetic strips on cards may be damaged.

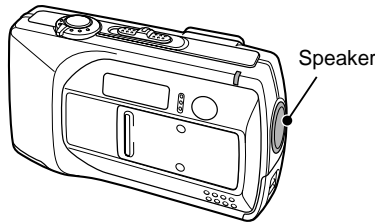

■ Cautions concerning data storage

- It is recommended that any important data be copied onto a separate media (such as a floppy disk, hard disk, or MO disk).
- Stored data may be lost (or corrupted) in cases such as those listed below. Sanyo Electric will not be held responsible for any damage or lost profits arising from the loss of data.
 - If the CompactFlash or Microdrive card is used incorrectly.
 - If the CompactFlash or Microdrive card is not inserted correctly into the digital camera.
 - If the CompactFlash or Microdrive card is subjected to electrical or mechanical shocks or other forces.
 - If the CompactFlash or Microdrive card is removed from the digital camera or if the digital camera is turned off during reading or writing operations.
 - If the CompactFlash or Microdrive card has reached the end of its usable life.

■ Cautions when handling the CompactFlash or Microdrive

- The CompactFlash and Microdrive cards are precision devices. Do not bend, drop, or subject them to strong forces or shocks. Be especially careful with the Microdrive for it is easily damaged by vibrations.
- Avoid using or storing the CompactFlash and Microdrive cards in places with extremely high or low temperatures, subject to direct sunlight, in a completely closed vehicle, near air conditioners or heaters, or in humid or dusty locations.
- Avoid using or storing the CompactFlash and Microdrive cards in locations where strong static electrical charges or electrical noise can be easily generated.
- Do not allow the edges of the CompactFlash and Microdrive cards to become contaminated with foreign materials. Gently wipe away any contamination with a soft, dry cloth.
- When not using the CompactFlash and Microdrive cards, put them back into their protective covers to protect them from damage due to static electricity.
- Do not carry the CompactFlash and Microdrive cards inside trouser pockets, as they may become damaged when you sit down or make other movements that may apply forces.
- Before using an unused card, be sure to format it using the digital camera (see page 122).
- When buying separately sold or commercially available products, carefully read the instructions and warnings that come with them.

CHECKING THE INCLUDED ACCESSORIES

Open the box and check that all the accessories listed below are included. The page numbers listed next to the part names are the page numbers where that part is explained in detail.

- **Hand-strap** [page 14]
- **Soft case** [page 14]
- **CompactFlash (8MB) and protective case***
- **4 AA nickel metal hydride rechargeable batteries** [page 21]

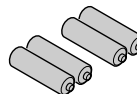
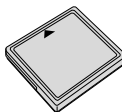
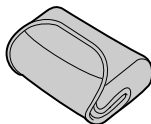
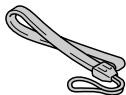

- **Nickel metal hydride battery charger and power cord** [page 21]
- **AV cable** [page 94]
- **Computer serial port interface cable** [page 126]

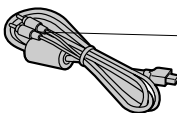
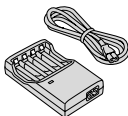
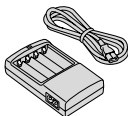

Model VAR-NC1

Model NC-LC03WSA

One of these is supplied.

- **Adaptor for Macintosh computer*** [page 126]
- **USB interface cable** [page 126]
- **Software: 2 CD-ROMs**

* Not supplied with the VPC-SX560E.

Media Cards that Can Be Used with this Digital Camera

This digital camera stores the captured images and recorded voice memos on the storage media card inserted inside the digital camera. The number of images and amount of recording time that can be stored on one card depends on the capacity of the card used and the recording conditions.

The types of card that can be inserted into and used with this digital camera are given below.

- **CompactFlash**
- **Microdrive**

There are special precautions that must be followed when using Microdrive cards. Before using Microdrive cards, carefully read "Cautions when using the Microdrive" (page 135).

The Use of "Card" in this Manual

- In this manual, CompactFlash and Microdrive cards that can be used in this digital camera are referred to as "card."
- The cards in the illustrations in this manual are CompactFlash cards, but all installation, removal, and formatting procedures are the same for both the CompactFlash and Microdrive cards.

USING THE HAND-STRAP AND SOFT CASE

Attach the supplied hand-strap to the digital camera to aid in carrying. Also, when you are not using the digital camera, put it in the soft case for protection.

Attaching the Hand-strap

Bend the looped extremity of the strap and slip it through then strap holder on the digital camera.

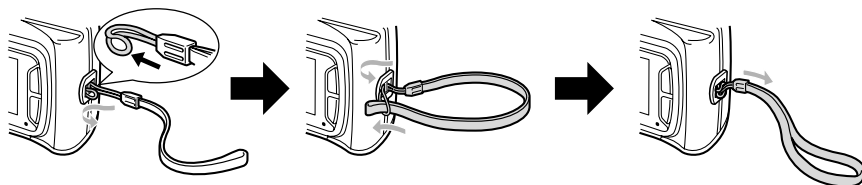

Using the Soft Case

Slide the hand-strap into the opening on the side of the case for carrying the digital camera.

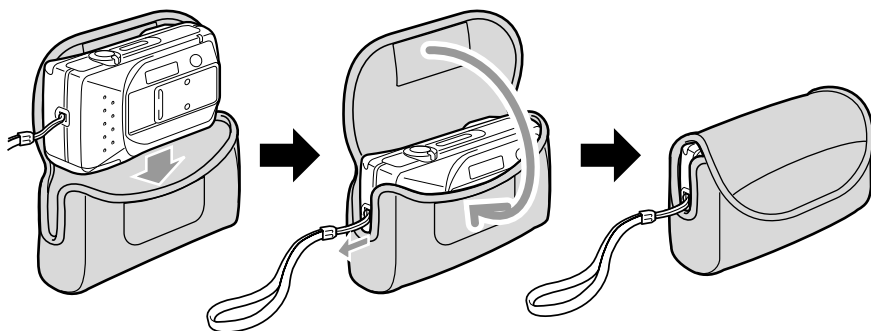

It can also be worn on a belt or the like.

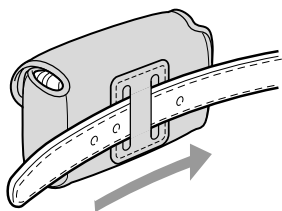

NOTE

- Even if the digital camera is inside its soft case, if it is subjected to strong shocks or impacts, it may fall out of its soft case.

QUICK START FOR CAPTURING IMAGES

Now that you have purchased a new digital camera, it is time to try and capture some images and then view them with the LCD monitor. Although your digital camera is packed with many useful and convenient functions, here is just a simple explanation of how to capture and view images. Afterward, carefully read the rest of this manual to get the most out of your digital camera.

Recharging the batteries (see page 21)

Recharge the supplied batteries before use.

1 Recharge the supplied batteries.

- Make sure the polarity (+), (-) of the batteries is as indicated on the battery charger.
- During recharge, the recharge indicator on the battery charger will light.
- When the batteries are recharged, the indicator will go off.
- The recharge time is approx. 210 minutes for four batteries. (Model NC-LC03WSA only)
- The recharge time is approx. 240 minutes for four batteries. (Model VAR-NC1 only)

Caution!

First recharge the supplied batteries. Do not recharge other batteries with the supplied battery charger. To ensure safety, read "Concerning the Batteries" on page 5 and "Concerning the Supplied Battery Charger" on page 7.

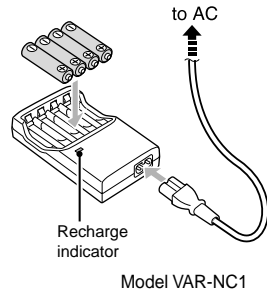
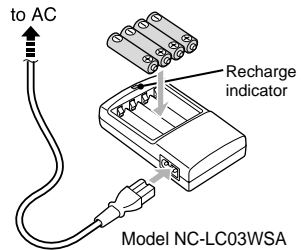

2 Remove the batteries from the battery charger.

- When finished (the recharge indicator turns off), unplug the power cord from the power outlet and remove the batteries.

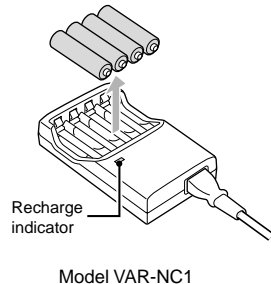
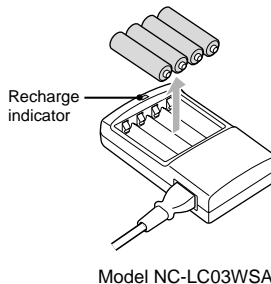

Installing the batteries and card (see pages 24, 25)

3 Insert the batteries.

- Use the batteries recharged in step 1 above.
 - Make sure the polarity ((+) and (-)) of the batteries is as indicated in the battery compartment.
- 1 Open battery compartment cover on digital camera bottom.
 - 2 Insert batteries.
 - 3 Close battery compartment cover.
 - 4 Push cover in the direction shown by arrow until it clicks.

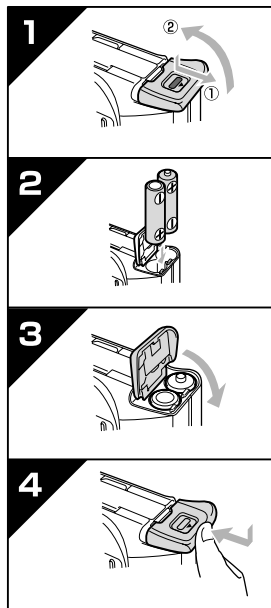

4 Insert the card.

- Make sure not to insert the card with it facing the wrong direction.
- 1 Open card slot cover on digital camera bottom.
 - 2 Insert card all the way.
 - 3 Push down eject button.
 - 4 Close card slot cover.
- After installing the card, be sure to first format it with the digital camera (see page 122).

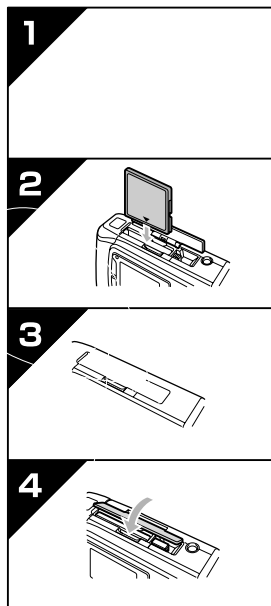

QUICK START FOR CAPTURING IMAGES

Capturing images (see page 56)

Now that preparation is completed, your digital camera is ready to capture images. Here we will capture still images, but your digital camera can take sequential shots and even film video clips.

5 Turn the selector dial to .

6 Set the main switch to "CAMERA."

7 Open the lens cover.

- An image appears in the LCD monitor.

8 Point the camera lens to the subject.

- Compose the desired image by looking at the LCD monitor.

9 Press the shutter release button halfway (focus-lock).

- The autofocus locks on the subject and the image in the LCD monitor appears clearly.

10 Finish pressing the shutter release button all the way.

- The image is captured.
- In the still image shooting mode, you can view the image captured on the LCD monitor by holding the shutter release button down.
- The stand-by indicator will flash in red while the image is being written to the memory. Another image can only be captured when the stand-by indicator lights green again.

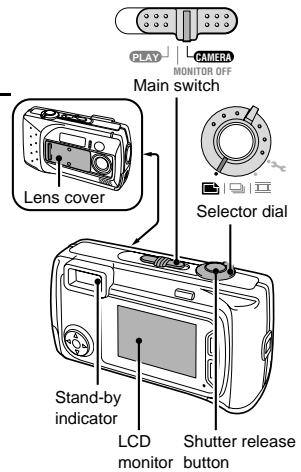

Push halfway

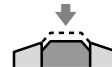

Push completely



HELP

What if the digital camera turns off by itself

- The power save function activated (see page 28). Perform the operations given below.
 - During shooting : Open and close the lens cover or press the shutter release button.
 - During playback : Open and close the lens cover or move the main switch from "PLAY" and back to "PLAY."

Viewing the image (see pages 83, 85)

Now let's take a look at the images you've captured.

11 Set the main switch to "PLAY."

- The image you captured shows up in the LCD monitor.
- Press ◀ or ▶ on the arrow button to display the images stored before and after the current image.

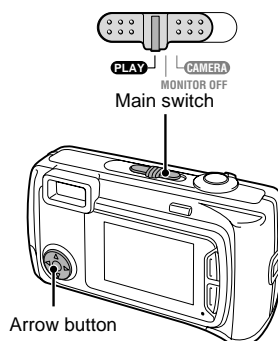

12 When finished, set the main switch to "MONITOR OFF" or "CAMERA" and close the lens cover.

- Your digital camera turns off.

How was it? Did everything turn out fine?

Of course what you have performed here is just a fraction of the many functions your digital camera is loaded with. But before you continue using your digital camera any further, be sure to read this instruction carefully.

PARTS NAMES

The page numbers listed next to the part names are the page numbers where that part is explained in detail.

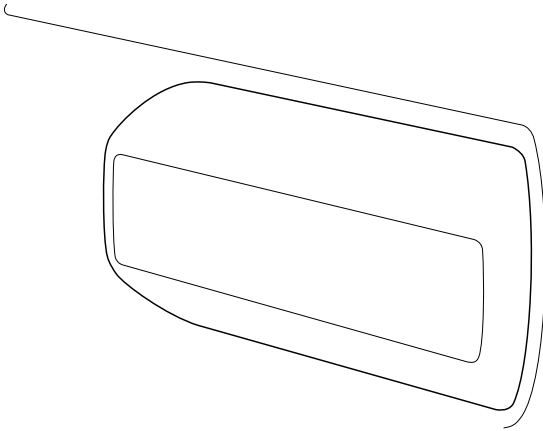

Rear

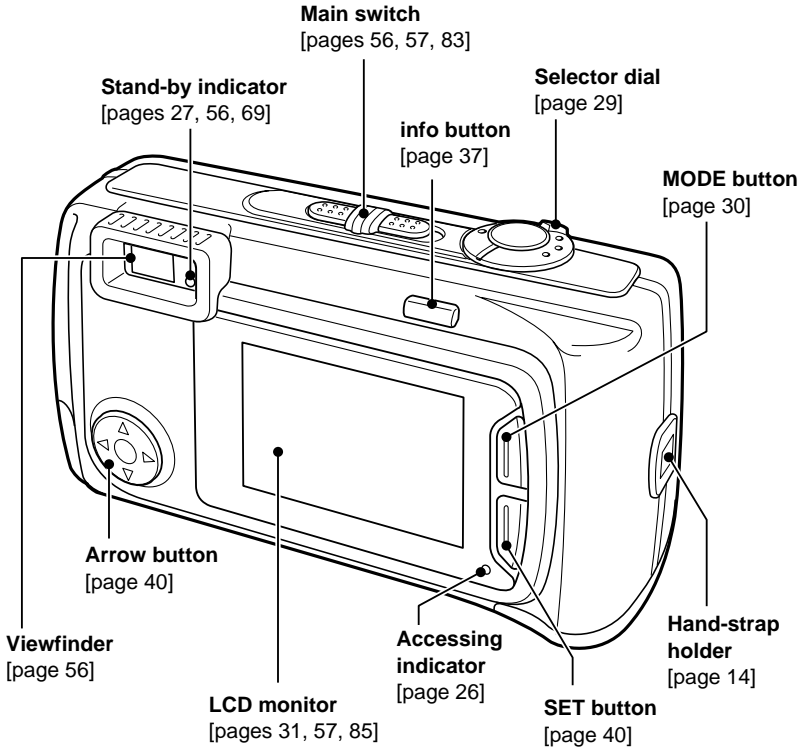

- * During use, the area around the LCD monitor may become warm. This is normal and does not indicate a malfunction.
- * When viewing the LCD monitor, you may see some missing pixels (seen as black and white dots). This is normal and does not indicate a malfunction.

Indications in the Viewfinder

Close-up correction marks [page 67]

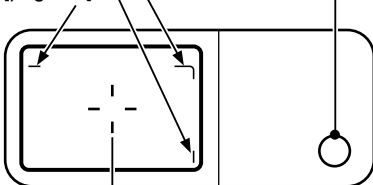

Auto-focus mark [page 56]

Stand-by indicator (red/green) [pages 27, 56, 69]

Red flashing: When capturing an image, charging the flash, or storing an image or sound recording (image or sound cannot be recorded)

Red steady: When the memory is full (image or sound cannot be recorded) [page 127]

Green flashing: When using the exposure correction or zoom functions (image and sound can be recorded) [pages 72, 73]

Green steady: Image and sound can be recorded

PREPARATION OF BATTERIES

Use the supplied (or sold separately) AA nickel metal hydride batteries to power the digital camera. You can also use AA Ni-Cd batteries, but they will not last as long as the AA nickel metal hydride rechargeable batteries. However, if you do not have access to these batteries, you may use alkaline batteries and capture images using the viewfinder (see page 56). Also note that the duration of operation provided by the alkaline batteries will be very short.

CAUTION

- Manganese batteries cannot be used, as they have an extremely short battery life and may overheat and damage the digital camera.
- For your safety, read “Concerning the Batteries” on page 5 and “Concerning the Supplied Battery Charger” on page 7 before handling the batteries.

Recharging Nickel Metal Hydride Batteries

Make sure to completely recharge the supplied nickel metal hydride batteries before use. Use only the supplied battery charger to recharge the batteries. This battery charger can be used for both the nickel metal hydride batteries (HR-3US or HR-3U, supplied with the digital camera or sold separately) and the Ni-Cd batteries (N-3US or N-3U, sold separately). Before using the batteries for the first time or when the batteries remaining charge is low (see “REMAINING BATTERY CHARGE INDICATION” on page 44), follow the steps below to recharge them.

1 Insert the batteries into the battery charger.

- Make sure the polarity ((+), (-)) of the batteries is as indicated on the charger.
- Make sure that the batteries are properly inserted all the way into the battery charger and not sticking up.
- You can charge from one to four batteries at the same time.

to AC
↑

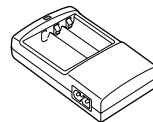

2 Insert the power cord into the socket on the battery charger.

3 Plug the power cord into a power outlet (AC 100 to 240 V).

- Recharge will start automatically.
- During recharge, the recharge indicator on the battery charger will light.

Recharge time of the supplied nickel metal hydride batteries: Model NC-LC03WSA: approx. 110 minutes for one or two batteries, and approx. 210 minutes for three or four batteries. Model VAR-NC1: approx. 120 minutes for one or two batteries, and approx. 240 minutes for three or four batteries.
--

NOTE

- The recommended ambient temperature when recharging is between 10°C and 35°C. If the temperature is less than 10°C, the batteries may be unable to be fully recharged.

4 When finished (the recharge indicator turns off), unplug the power cord from the power outlet.

5 Remove the batteries from the battery charger.

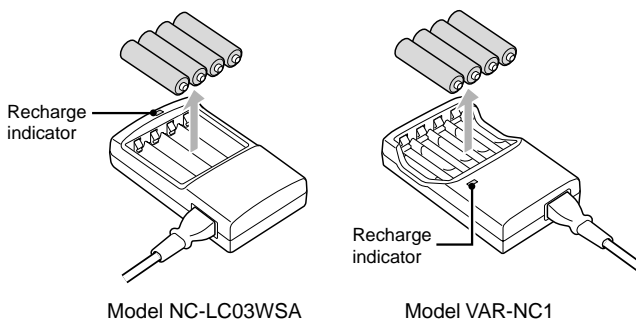



Recharge indicator

The recharge indicator allows you to check the condition of the battery charger. If the recharge indicator begins flashing, it indicates a problem. Refer to the table below to check the battery charger condition.

Recharge indicator	Condition of battery charger
Off	Power is not supplied to the battery charger. <ul style="list-style-type: none"> ● Plug the power cord into a power outlet when using the battery charger. Charging is complete. ● Unplug the power cord from the power outlet.
On	Charging.
Slow flashing (one flash/2-second: Model NC-LC03WSA only) (one flash/second: Model VAR-NC1 only)	There is a problem with the batteries. <ul style="list-style-type: none"> * Immediately remove the batteries and make sure that the batteries are not overheating. <ul style="list-style-type: none"> ● Once the faulty batteries are removed and only good batteries remain, the recharge indicator will stop flashing and remain lit. You can now resume charging. ● Do not use faulty batteries.
Fast flashing (four flashes/second: Model VAR-NC1 only)	There is a problem with the battery charger (perform the procedures given below). <ol style="list-style-type: none"> (1) Immediately unplug the power cord from the power outlet. (2) Check for smoke or other problems. (3) If a problem exists, stop using the battery charger and contact the place of purchase. (4) If there is no problem, plug in the battery cord and check the recharge indicator. <ul style="list-style-type: none"> ● If it lights, the battery charger is ready for use. ● If it begins flashing again, unplug the power cord and contact the place of purchase.

PREPARATION OF BATTERIES

Using the Nickel Metal Hydride Batteries Properly

- **Periodically clean with a dry cloth the terminals of the nickel metal hydride batteries ((+) and (-)) and the terminals located in the battery compartment of the digital camera.**
Do not touch the battery terminals or the terminals in the battery compartment of the digital camera with your bare hands. Doing so will allow contaminants from your hands to adhere to the terminals and oxidize and increase the contact resistance. If the contact resistance increases, the usable life of the batteries will diminish.
- If you repeatedly remove the nickel metal hydride batteries before they run out and recharge them, or place them into the digital camera before they are fully recharged, then a “memory effect”^{**} may occur.
- Your digital camera is designed to handle the effects from voltage fluctuations caused by the “memory effect” of nickel metal hydride batteries. Nevertheless, there are times when the remaining charge indicator may show  or  earlier than usual.
- If any symptoms such as these occur, first discharge the batteries completely (see page 124) and then recharge them until they are fully charged again.

* Memory effect

Memory effect is a phenomenon where the battery performance temporarily lowers. In general, the battery voltage during use drops below its normal voltage until it is fully discharged and recharged again.

NOTE

- New batteries must be recharged before they are first used.
- Even if recharged batteries are stored and not used, they will slowly lose their charge. They must be recharged before they are used again.
- If the batteries are used for the first time or if they have not been used for a long time, they may not be recharged completely even when the recharge indicator goes off. The batteries will return to normal after they have been used and recharged two or three times.
- The batteries may have reached the end of their service life if the recharge indicator keeps on flashing even if the batteries have been inserted correctly, or if they overheat while being recharged. However, if the same conditions appear with new batteries, or if the recharge indicator does not go off after the normal time required, it may indicate a problem of the battery charger. In such a case, stop using it immediately and take it to the dealer for service.
- During recharging, the battery charger and batteries will be warm. This is normal and does not indicate a malfunction.
- During recharging, the battery charger may create interference with a radio or TV. In such a case, make sure to plug the battery charger into a power outlet on a circuit different from the one of the radio or TV.

Installing the Batteries

1 Set the main switch to “MONITOR OFF” or “CAMERA.”

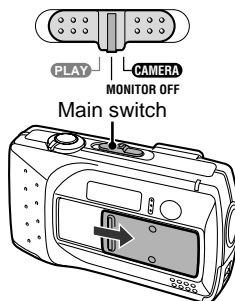

2 Close the lens cover.

3 Open the battery compartment cover on the bottom of the digital camera.

- Push the button on the compartment cover and slide it outward to open it.

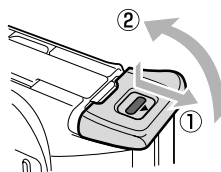

4 Insert two recharged nickel metal hydride batteries in the battery compartment.

- Make sure the polarity ((+), (-)) of the batteries is as indicated in the battery compartment.

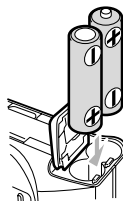

5 Close the battery compartment cover.

- Slide the compartment cover in the direction of the arrow until it clicks.

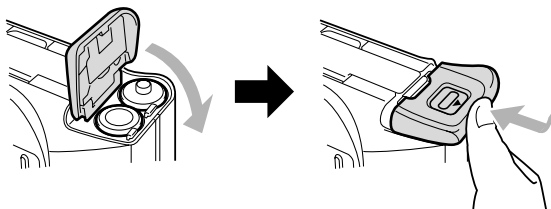

NOTE

- Battery power is still used even when the digital camera is turned off. It is recommended that you remove the batteries from the digital camera when it is not being used. However, when the batteries are removed for a long period, the date and time settings may be cleared. When reinstalling recharged batteries, recheck the date and time settings (see page 41).

INSTALLING AND REMOVING THE CARDS

The images and audio recordings recorded by your digital camera are stored on the data storage card installed in the digital camera. You must install a card before you can capture images. For more information on handling the cards, see “Cautions when handling the CompactFlash or Microdrive” on page 12 and “Cautions when using the Microdrive” on page 135. Before using a card for the first time, format it using the digital camera (see page 122).

Installing a Card

1 Set the main switch to “MONITOR OFF” or “CAMERA.”

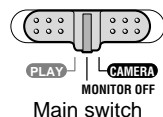

2 Close the lens cover.

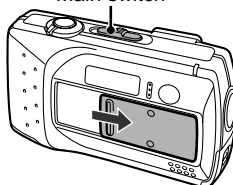

3 Make sure the power is turned off, then open the card slot cover on the bottom of the digital camera.

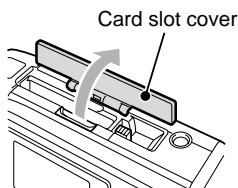

4 Insert the card.

- Make sure the contacts are facing downward and insert the card in the direction shown by the arrow (▼ mark).
- Be sure to insert the card all the way until it is fully inserted.

5 Push down the eject button and close the card slot cover.

- When a card is inserted, the eject button will stand up. Push down the eject button in the direction indicated by the arrow.

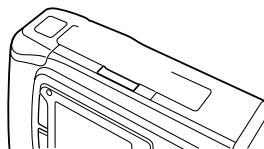

Removing a Card

1 Set the main switch to "MONITOR OFF" or "CAMERA."

2 Close the lens cover.

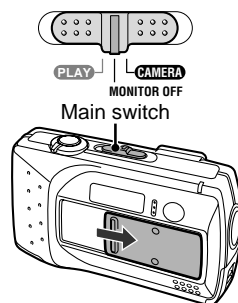

3 Make sure the accessing indicator is not flashing, then open the card slot cover on the bottom of the digital camera.

- If the accessing indicator is lit or flashing, then the digital camera is writing to the card. Never remove the card at this time.

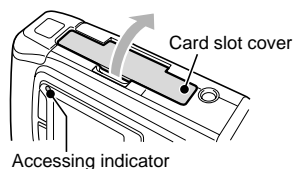

4 Stand up the eject button.

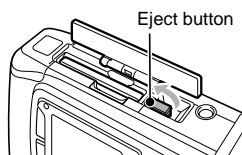

5 Push in the eject button and remove the card.

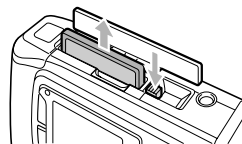

6 Close the card slot cover.

NOTE

- By using the card together with a commercially available PC card adaptor for CompactFlash cards, the card can be used as a PC card conforming to PC Card Standard-ATA.

TURNING THE POWER ON/OFF

Turning the Power On

Follow the steps indicated below when capturing images or when playback images on the LCD monitor.

To capture images

1 Set the main switch to “MONITOR OFF” or “CAMERA.”

“MONITOR OFF”: To not use the LCD monitor.

“CAMERA”: To use the LCD monitor.

2 Open the lens cover.

- The power is turned on.
- The stand-by indicator lights green in the viewfinder window.
- If the main switch was set to “CAMERA” in step 1, the LCD monitor will turn on and an image will appear.

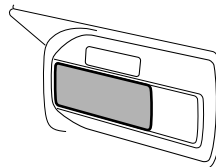

To playback images

1 Set the main switch to “PLAY.”

- The power is turned on.
- An image appears in the LCD monitor.
- Images can be played back whether the lens cover is opened or closed. However, to protect the lens, we recommend that you keep the cover closed.

HELP

If “NO CARD” appears

- If no card is installed in the digital camera, then “NO CARD” will appear in the LCD monitor. Be sure to install a card before using the digital camera (see page 25).

Turning the Power Off

- 1 Set the main switch to "MONITOR OFF" or "CAMERA."

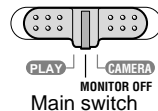

- 2 Close the lens cover.

- The power turns off.
- The stand-by indicator turns off.
- If the main switch was set to "CAMERA," the LCD monitor turns off.

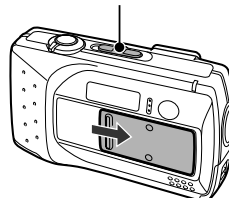
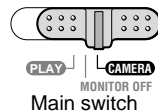

Turning the Power On when the Power Save Function is Active

In order to save the battery power, the power save function will automatically turn off the power after one minute of no use in the camera mode, or five minutes of no use in the image playback mode.

To restore power for capturing images

- 1 Close and open the lens cover, or press the shutter release button once.

To restore power for viewing images

- 1 Close and open the lens cover, or set the main switch to another position, then back to "PLAY."

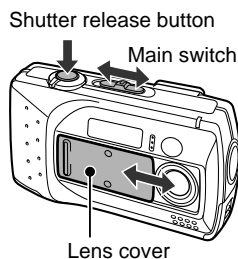

NOTE

- When using the AC adaptor (sold separately), the power save function will become active after about 30 minutes of inactivity. Also, when using battery power and connecting the digital camera to a personal computer, the power save function will become active after about five minutes of no use.
- By connecting your digital camera to a computer, you can set the time that needs to elapse before the power save function activates. For more details, refer to the instruction manual supplied with the SANYO Software Pack.

DISPLAYING THE SETTING SCREEN AND OPTION SETTING SCREEN

For both shooting and playback, there is a Setting Screen and an Option Setting Screen. These screens allow you to perform various settings and operations (see pages 31 to 36).

Displaying the Setting and Option Setting Screens

1 Set the main switch to "CAMERA" or "PLAY."

CAMERA: To display a Shooting Setting Screen or the Shooting Option Setting Screen.

PLAY: To display a Playback Setting Screen or the Playback Option Setting Screen.

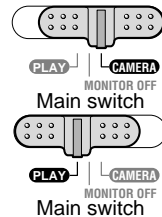

2 For the shooting, open the lens cover.

- An image appears in the LCD monitor.

3 Turn the selector dial to the mark for the desired setting screen.

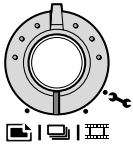
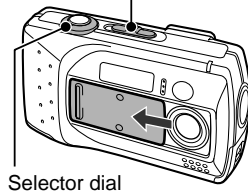



	Shooting	Playback
	Still Image Shooting Setting Screen	Still Image Playback Setting Screen
	Sequential Shot Shooting Setting Screen	Sequential Shot Playback Setting Screen
	Video Clip Shooting Setting Screen	Video Clip Playback Setting Screen
	Shooting Option Setting Screen <ul style="list-style-type: none"> • Audio recording • Date and time setting • Operational sound setting • Battery discharging • Language selection • Card initializing (reformatting) 	Playback Option Setting Screen <ul style="list-style-type: none"> • Sound playback • Date and time setting • Operational sound setting • Battery discharging • Language selection • Card initializing (reformatting) • Game

NOTE

If "NO IMAGE" appears

- This appears if there is no image for the playback mode you selected. Turn the selector dial to a playback mode for which images exist.

4 Press the MODE button.

- The setting screen selected in step 3 appears.
- When the selector dial is set to  for playback, then the Still Image Playback Setting Screen appears. When the selector dial is set to  or , a 9-image display appears for image selection of steps 3 (see page 84). If this screen appears, press the SET button and then the MODE button.
- For how to operate the setting screens, see “SETTING SCREEN BASIC OPERATIONS” on page 40.

Exiting the Setting Screens

Press the MODE button

- The Setting Screen disappears.

Exiting the Option Setting Screens

Turn the selector dial to a mark other than .

- The Option Setting Screen is exited and either a shooting screen or playback screen appears.

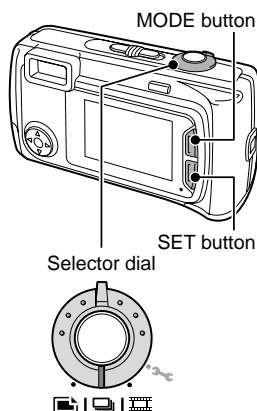

SHOOTING SETTING SCREENS

Still Image Shooting Setting Screen

* All the icons never appear at the same time.

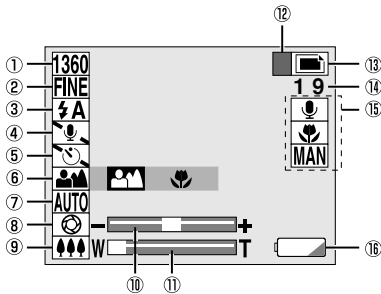

① **Resolution menu** [page 51]

- 1360**: 1360 x 1024-pixel resolution icon
- 1024**: 1024 x 768-pixel resolution icon
- 640**: 640 x 480-pixel resolution icon

② **Compression menu** [page 53]

- FINE**: FINE icon (low compression)
- NORM**: NORM icon (moderate compression)
- TIFF**: TIFF icon (no compression)
Only appears when the resolution is set to **1360**.

③ **Flash menu** [page 68]

- ⚡A**: Automatic flash icon
- ⚡**: Forced flash icon
- ⚡/**: Flash off icon

④ **Voice memo menu** [page 70]

- 🔇**: Voice memo off icon
- 🔊**: Voice memo on icon

⑤ **Self-timer menu** [page 71]

- 🕒**: Self-timer off icon
- 🕒**: Self-timer on icon

⑥ **Focus menu** [page 67]

- 📷**: Normal focus icon
- 📷**: Macro focus icon

⑦ **Auto/manual shooting menu** [page 55]

- AUTO**: Auto shooting mode icon
- MAN**: Manual shooting mode icon

⑧ **Exposure correction icon** [page 72]

⑨ **Zoom icon** [page 73]

Only appears when the resolution is set to **640**.

⑩ **Exposure correction bar** [page 72]

⑪ **Zoom bar** [page 73]

Only appears when the resolution is set to **640**.

⑫ **Main switch setting**

Red when the main switch is set to "CAMERA."

⑬ **Still image shooting mode icon**

⑭ **Number of images that can be captured** [page 46]

⑮ **Shooting status display area** [page 34]

When the Shooting Setting Screen is exited, the voice memo on icon, macro focus icon, or manual shooting mode icon appears if set.

⑯ **Remaining battery charge** [page 44]

Not displayed when the remaining battery charge is near full or when the AC adaptor (sold separately) is used.

Sequential Shot Shooting Setting Screen

* All the icons never appear at the same time.

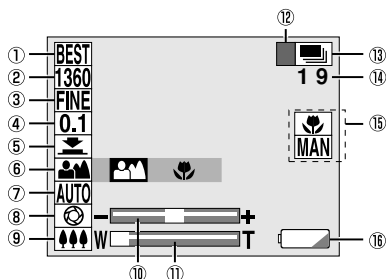

- ① **Sequential shot method menu** [pages 58 to 63]
Displays the selected sequential shot method even when Shooting Setting Screen is exited.
BEST: Best select shot icon
STAN: Standard sequential shot icon
AE: AE shift sequential shot icon
- ② **Resolution menu** [page 51]
1360: 1360 x 1024-pixel resolution icon
1024: 1024 x 768-pixel resolution icon
640: 640 x 480-pixel resolution icon
- ③ **Compression menu** [page 53]
FINE: FINE icon (low compression)
NORM: NORM icon (moderate compression)
- ④ **Sequential shot speed menu** [page 59]
0.03: 0.03-second interval icon
Only appears when the resolution is set to 640.
0.06: 0.06-second interval icon
0.1: 0.1-second interval icon
- ⑤ **Shutter operation menu** [page 59]
Only appears when the sequential shot method is set to STAN.
Images are captured only while the shutter release button is pressed.
Capturing of the images starts when the shutter release button is pressed and stops when it is pressed again.

- ⑥ **Focus menu** [page 67]
Normal focus icon
Macro focus icon
- ⑦ **Auto/manual shooting menu** [page 55]
AUTO: Auto shooting mode icon
MAN: Manual shooting mode icon
- ⑧ **Exposure correction icon** [page 72]
Only appears when the sequential shot method is set to BEST or STAN.
- ⑨ **Zoom icon** [page 73]
Only appears when the resolution is set to 640.
- ⑩ **Exposure correction bar** [page 72]
Only appears when the sequential shot method is set to BEST or STAN.
- ⑪ **Zoom bar** [page 73]
Only appears when the resolution is set to 640.
- ⑫ **Main switch setting**
Red when the main switch is set to "CAMERA."
- ⑬ **Sequential shot shooting mode icon**
- ⑭ **Number of images that can be captured** [page 46]
- ⑮ **Shooting status display area** [page 34]
When the Shooting Setting Screen is exited, the macro focus icon or manual shooting mode icon appears if set.
- ⑯ **Remaining battery charge** [page 44]
Not displayed when the remaining battery charge is near full or when the AC adaptor (sold separately) is used.

SHOOTING SETTING SCREENS

Video Clip Shooting Setting Screen

* All the icons never appear at the same time.

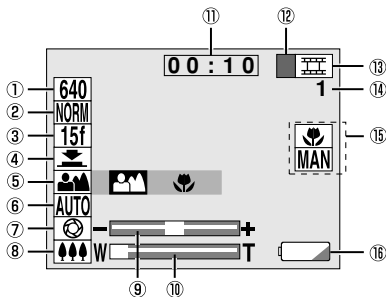

① **Resolution menu** [page 51]

- 640**: 640 x 480-pixel resolution icon
- 320**: 320 x 240-pixel resolution icon
- 160**: 160 x 120-pixel resolution icon

② **Compression menu** [page 53]

- FINE**: FINE icon (low compression)
Only appears when the resolution is set to **320**.
- NORM**: NORM icon (moderate compression)

③ **Frame rate menu** [page 64]

- 15f**: Records at 15 frames/second.
- 30f**: Records at 30 frames/second.
Only appears when the resolution is set to **320** or **160**.

④ **Shutter operation menu** [page 64]

- : Records only while shutter release button is pressed.
- : Recording starts when shutter release button is pressed and stops when it is pressed again.

⑤ **Focus menu** [page 67]

- : Normal focus icon
- : Macro focus icon

⑥ **Auto/manual shooting menu** [page 55]

- AUTO**: Auto shooting mode icon
- MAN**: Manual shooting mode icon

⑦ **Exposure correction icon** [page 72]

⑧ **Zoom icon** [page 73]

Only appears when the resolution is set to **320** or **160**.

⑨ **Exposure correction bar** [page 72]

⑩ **Zoom bar** [page 73]

Only appears when the resolution is set to **320** or **160**.

⑪ **Remaining recording time available** [page 65]

Display shows the remaining minutes and seconds.

⑫ **Main switch setting**

Red when the main switch is set to "CAMERA."

⑬ **Video clip shooting mode icon**

⑭ **Number of video clips that can be recorded** [page 65]

⑮ **Shooting status display area** [page 34]

When the Shooting Setting Screen is exited, the macro focus icon or manual shooting mode icon appears if set.

⑯ **Remaining battery charge** [page 44]

Not displayed when the remaining battery charge is near full or when the AC adaptor (sold separately) is used.

Shooting Status Display Area

After you exit the Shooting Setting Screen, the status of the digital camera and card are displayed in this shooting status display area. For a more detailed view of the setting status, change to the Information Screen (see pages 37 to 39).

* All the icons never appear at the same time.

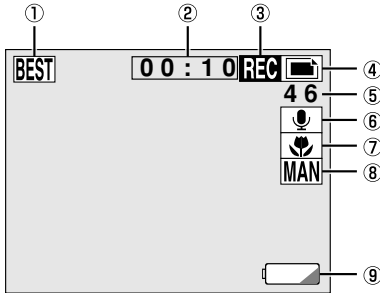

- ① **Sequential shot method menu** [pages 58 to 63]

Displays the sequential shot method selected.

BEST: Best select shot icon

STAN: Standard sequential shot icon

AE: AE shift sequential shot icon

- ② **Remaining recording time available** [page 65]

Display shows the remaining minutes and seconds when recording a video clip.

- ③ **REC (recording) indicator** [pages 60, 65, 70]

Appears during recording of a sequential shot, video clip, audio recording, and voice memo.

- ④ **Display of shooting mode**

Displays the shooting mode selected with the selector dial.

: Still image shooting icon [page 31]

: Sequential shot shooting icon [page 32]

: Video clip shooting icon [page 33]

- ⑤ **Number of images (video clips) that can be captured (recorded)** [page 46]

For still image and sequential shooting, this displays the number of images that can be captured, and for video clip shooting, this displays the number of clips that can be taken.

- ⑥ **Voice memo indicator** [page 70]

Appears when recording a voice memo (audio recording).

- ⑦ **Macro shooting indicator** [page 67]

Appears when shooting with macro focus.

- ⑧ **Manual shooting mode indicator** [page 55]

Appears when shooting in the manual mode.

- ⑨ **Remaining battery charge** [page 44]

Not displayed when the remaining battery charge is near full or when the AC adaptor (sold separately) is used.

PLAYBACK SETTING SCREEN

Still Image, Sequential Shot, and Video Clip Playback Setting Screens

* All the icons never appear at the same time.

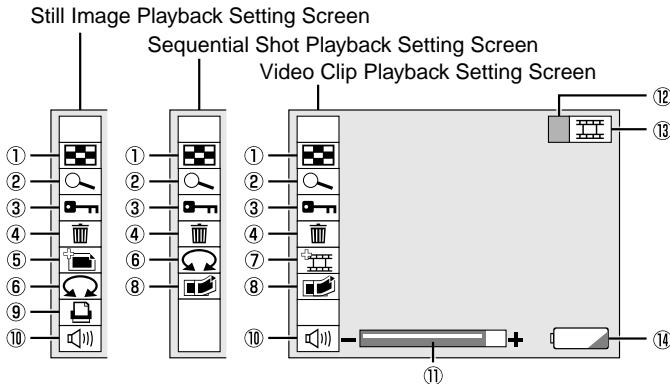

① **9-image display icon** [pages 87, 88, 89]

② **Playback zoom icon** [page 91]

③ **Protect mode icon** [page 109]

④ **Erase mode icon** [page 110]

⑤ **Edit still image icon** [pages 95, 99, 101]

⑥ **Image rotation icon** [page 85]

⑦ **Edit video clip icon** [pages 105, 107]

⑧ **Copy icon** [page 112]

⑨ **Print icon** [page 113]

⑩ **Volume icon** [page 85]

Only appears in the Still Image Playback Setting Screen when an image with a voice memo appears.

⑪ **Volume bar** [page 85]

Not displayed for the Sequential Shot Playback Setting Screen.

⑫ **Main switch setting**

Green when the main switch is set to "PLAY."

⑬ **Playback mode icon** [page 83]

: Still image playback icon

: Sequential shot playback icon

: Video clip playback icon

⑭ **Remaining battery charge** [page 44]

Not displayed when the remaining battery charge is near full or when the AC adaptor (sold separately) is used.

OPTION SETTING SCREEN

Shooting Option Setting Screen

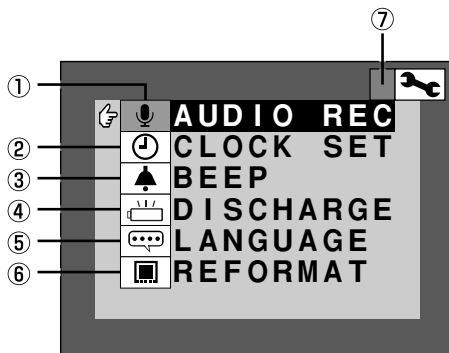

- ① **Audio recording** [page 81]
- ② **Date and time setting** [page 41]
- ③ **Operational sound setting** [page 74]
- ④ **Battery discharge function** [page 124]
- ⑤ **Language selection** [page 125]
- ⑥ **Card reformatting** [page 122]
- ⑦ **Main switch setting**
Red when the main switch is set to "CAMERA."

Playback Option Setting Screen

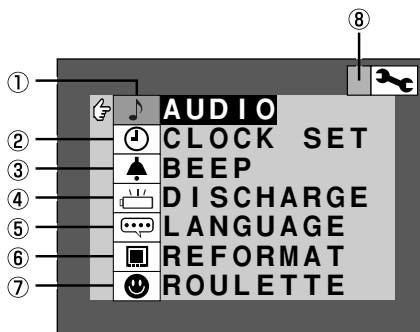

- ① **Playback of audio recordings** [pages 84, 92]
- ② **Date and time setting** [page 41]
- ③ **Operational sound setting** [page 74]
- ④ **Battery discharge function** [page 124]
- ⑤ **Language selection** [page 125]
- ⑥ **Card reformatting** [page 122]
- ⑦ **Roulette game** [page 117]
- ⑧ **Main switch setting**
Green when the main switch is set to "PLAY."

INFORMATION DISPLAY (info BUTTON)

The Information Screen allows you to check the current settings while shooting. Also, during playback, you can check what the settings were during shooting.

Information Screen During Shooting

1 Put the digital camera in the shooting/recording status.

For still image shooting, see page 57.

For sequential shot shooting, see page 59.

For video clip shooting, see page 64.

For audio recording, see page 81.

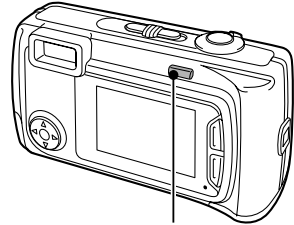

info button

2 Press the info button.

- The Information Screen appears.

■ To exit the Information Screen, press the info button again.

Still Image Shooting Information Screen

- ① Resolution setting [page 51]
- ② Flash setting [page 68]
- ③ Voice memo setting [page 70]
- ④ Auto/manual shooting setting [page 55]
For manual shooting **MAN**, the settings for manual shooting appear.
- ⑤ Self-timer setting [page 71]
- ⑥ Focus setting [page 67]
- ⑦ Compression setting [page 53]
- ⑧ Number of images that can be captured [page 46]
- ⑨ Remaining battery charge [page 44]

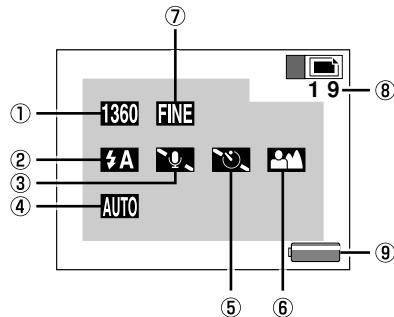

Sequential Shot Shooting Information Screen

- ① **Sequential shot method setting** [pages 59, 60, 62]
- ② **Sequential shot speed setting** [pages 59, 60, 62]
- ③ **Shutter operation setting** [page 59]
- ④ **Auto/manual shooting setting** [page 55]
For manual shooting **[MAN]**, the settings for manual shooting appear.
- ⑤ **Focus setting** [page 67]
- ⑥ **Resolution setting** [page 51]
- ⑦ **Compression setting** [page 53]
- ⑧ **Remaining number of images that can be captured** [page 46]
- ⑨ **Remaining battery charge** [page 44]

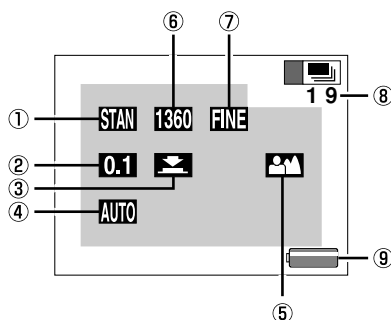

Video Clip Shooting Information Screen

- ① **Resolution setting** [page 51]
- ② **Shutter operation setting** [page 64]
- ③ **Auto/manual shooting setting** [page 55]
For manual shooting **[MAN]**, the settings for manual shooting appear.
- ④ **Frame rate setting** [page 64]
- ⑤ **Focus setting** [page 67]
- ⑥ **Compression setting** [page 53]
- ⑦ **Remaining recording time available (min:sec)** [page 82]
- ⑧ **Remaining number of video clips that can be recorded** [page 46]
- ⑨ **Remaining battery charge** [page 44]

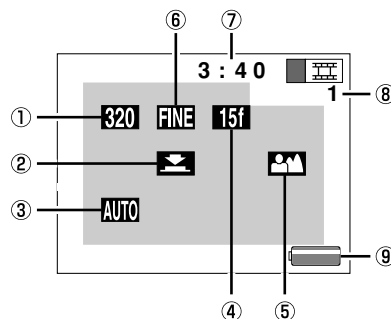

Audio Recording Information Screen

- ① **Remain recording time available (min:sec)** [page 82]
- ② **Sound quality setting** [page 81]
- ③ **Shutter operation setting** [page 81]
- ④ **Number of audio recording that can be recorded** [page 47]
- ⑤ **Remaining battery charge** [page 44]

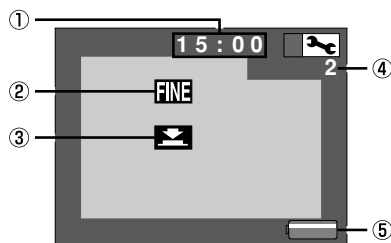

INFORMATION DISPLAY (info BUTTON)

Information Screen During Playback

Displaying the shooting settings during playback.

1 Display the image or audio file for playback.

For still images, see page 85.

For sequential shots, see page 88.

For video clips, see page 89.

For audio recordings, see page 92.



2 Press the info button.

- The Information Screen appears.

■ To exit the Information Screen, press the info button again.

Still image, Sequential Shot, and Video Clip Playback Information Screen

* All the icons never appear at the same time.

- ① Location of data (folder no.) and file name [page 49]
- ② Date and time image was captured [page 41]
- ③ Length of recording (min:sec) (only appears in video clip playback mode)
- ④ Playback mode [page 83]
: Still image playback mode
: Sequential shot playback mode
: Video clip playback mode
- ⑤ Resolution [page 51]
- ⑥ Compression type [page 53]
- ⑦ Protect mode setting [page 109]
(Frame rate setting appears in the video clip playback mode)

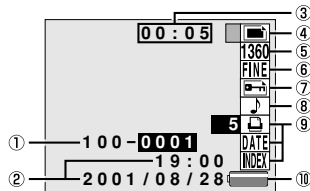

- ⑧ Voice memo [page 85] (only appears in still image playback mode and the protect mode setting appears in the video clip playback mode)
- ⑨ Print setting [page 116] (only appears in still image playback mode)
- ⑩ Remaining battery charge [page 44]

Audio Recording Playback Information Screen

* All the icons never appear at the same time.

- ① Location of data (folder no.) and file name [page 49]
- ② Date and time recorded [page 41]
- ③ Length of recording (min:sec)
- ④ Sound quality [page 81]
- ⑤ Protect mode setting [page 109]
- ⑥ Remaining battery charge [page 44]

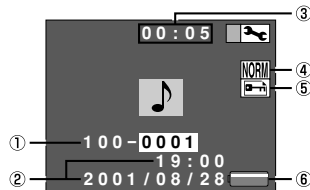

NOTE

- When an Information Screen appears, video clip playback, auto playback, and audio playback cannot be performed.

SETTING SCREEN BASIC OPERATIONS

At the setting screens, use the arrow button and SET button to perform the desired settings. The selected menu or icon will change to reverse video or turn orange in color. To enter or exit the

SETTING THE DATE AND TIME

The digital camera will record the date and time an image or audio recording is taken so that you can display them during playback. Therefore, before capturing images, make sure the correct date and time are set.

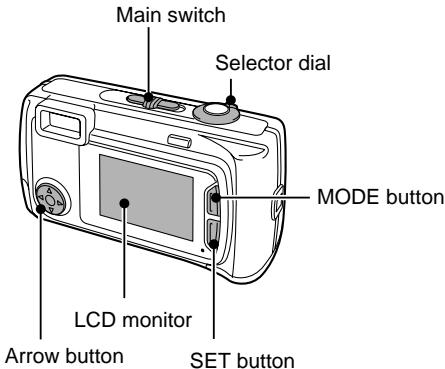

Example: To set the clock to August 28, 2001 at 7:30 p.m.

1 Display the Shooting Option Setting Screen (or Playback Option Setting Screen) (see page 29).

2 Press **▼** button on the arrow button to select “**CLOCK SET**,” and then press the **SET** button.

- The **CLOCK SET** menu appears.
- The current date and time settings appear.
- Follow the procedures below to set whether to display the date during playback, to set the date and time, and to set the display format for the date.
- To return to the Option Setting Screens, press the **MODE** button, or select “**EXIT**” and press the **SET** button.

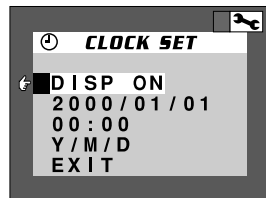

NOTE

- If the date and time are not set, January 1, 2000 midnight is recorded as the date and time. Consequently, “2000/01/01 00:00” appears during playback.
- Under normal conditions, while the batteries are replaced, an internal battery will maintain the date and time settings. However, there is a small chance the settings may be lost. (The backup will last for approx. 30 minutes.) It is recommended to check that the date and time settings are still correct after replacing the batteries and before shooting or recording of any type (follow steps 1 and 2).

- ② Press ▲ or ▼ to select
DISP [ON]: Display
DISP [OFF]: Does
- ③ Press the SET button
 - Setting of whether completed.
 - To set the clock,
 - To return to the C
MODE button, or

4 Set the clock (date)

- ① Press ▼ to select the
- ② Press the SET button
 - The year turns on
- ③ Using the arrow and
"2001/08/28."
 - Year setting → SET
button → Day setting
 - Press ▲ to decrease
 - Press ▼ to increase
- ④ Press the SET button
 - This completes the
- ⑤ Press ▼ to select the
- ⑥ Press the SET button
- ⑦ Using the arrow and
"19:30."
 - Hour setting →
 - The hour
- ⑧ Press
 - T

SETTING THE DATE AND TIME

5 Set the desired date display format.

- ① Press ▼ to select the display format.
- ② Press the SET button.
 - The date format turns orange.
- ③ Press ▲ or ▼ to select the desired display format.
Y/M/D: Year/month/day
M/D/Y: Month/day/year
D/M/Y: Day/month/year
- ④ Press the SET button.
 - This completes the date display format setting.

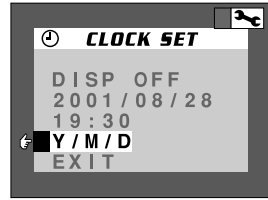

6 Select "EXIT" and press the SET button.

- The date and time setting is completed and you return to the Option Setting Screen.

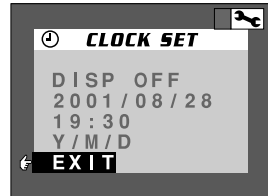

NOTE

To correct the date and time settings.

- After steps 1 and 2, press ▼ to move the ⤴ mark to the line of the setting that you want to change and press ► to select that setting. Then press ▲ or ▼ to set the new setting and the SET button to finalize the new settings.

REMAINING BATTERY CHARGE INDICATION



When using the nickel metal hydride batteries, the remaining battery charge can be checked on the LCD monitor. Make sure to check this indicator before capturing an image. For an indication of the possible length of time for battery operation, see “Battery Operation” on page 132.



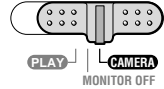



1 Set the main switch to “CAMERA” and open the lens cover.

- Set the selector dial to anything other than .



2 Press the info button.

- The Information Screen will appear and the batteries remaining charge indicator appears in the lower right corner of the LCD monitor. (If any data is present, you can also check the remaining battery charge at the Information Screen of the playback mode. See page 39.)
-  and  (flashing) will appear even when the Information Screen is not displayed.

Indicator		Remaining charge
Information Screen	When Information Screen is not displayed	
	No indication	Approx. full.
	No indication	Battery power is low.
		It will soon be impossible to capture or playback images. The remaining charge is not sufficient to download the pictures to a computer.
 Flashing	 Flashing	If this icon flashes when the shutter button is pressed, images cannot be captured. If it flashes while editing a video clip, the editing cannot be performed. Recharge the batteries.

- Due to the battery characteristics, when the ambient temperature is low,  may appear early for an incorrect indication of the remaining charge. Also, depending on the conditions of use of the digital camera or the ambient conditions (temperature, etc.), the indicated remaining charge may change. Therefore, this indication can only be used as a general approximation of the remaining charge.

■ **To cancel the display, press the info button.**

REMAINING BATTERY CHARGE INDICATION

NOTE

- The remaining battery charge indicator will give an accurate indication of the remaining charge only when the supplied nickel metal hydride batteries are used. The indication will not be accurate if you are using Ni-Cd batteries.
- For optimum performance, only use Sanyo nickel metal hydride batteries. If you are using Ni-Cd batteries, the possible operation time will be much shorter.
- Depending on the usage of the digital camera (such as the number of times the flash is used, the use of the LCD monitor, etc.) or the environmental conditions (temperature, etc.) the number of images that can be saved on a set of fully charged batteries will vary greatly.

HELP

If the LCD monitor goes off suddenly

- When capturing images using the LCD monitor and the battery charge is about half full, the LCD monitor may turn off momentarily. This is to allow a quick recharge of the flash. When the flash has been recharged, the LCD monitor will come back on automatically.

CHECKING THE REMAINING NUMBER OF IMAGES, VIDEO RECORDING TIME, AND AUDIO RECORDING TIME

The images, video clips, and audio recordings you take are stored on the card installed in the digital camera. If a card is not loaded into the digital camera or if the card is full, capturing or playing back images will not be possible. Make sure to check the status of the card in the digital camera before capturing images. For an indication of how many images can be captured and how much recording time is available for your card, see “Possible No. of Images/Possible Shooting Time/Possible Recording Time” on page 133.

Checking the Remaining Number of Images and Video Recording Time

1 Set the main switch to “CAMERA.”

2 Open the lens cover.

- Set the selector dial to anything other than .
- The remaining number of images appears in the upper right of the LCD monitor (for the still image and sequential shot shooting modes).
- The remaining video recording time appears in the top of the LCD monitor and the remaining number of video clips appears in the upper right of the LCD monitor (for the video clip shooting mode).
- The remaining number of images and video recording time will differ depending on the resolution and compression settings.
- When the remaining number of images or video clips that can be taken is “0,” you cannot capture any more images. To capture more images, either install a new card, or save the current images (see page 48) and then erase them (see page 110) from the card.
- When the remaining number of images or video clips that can be taken is “0,” it may be possible to capture a few more images by changing the shooting mode, setting a lower resolution setting (see page 51), or selecting a different compression setting (see page 53).

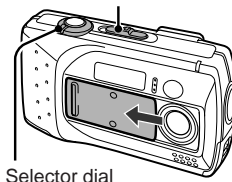
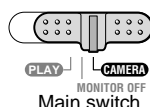

Remaining number of images possible
(Still image shooting screen)

Remaining video recording time (min:sec)

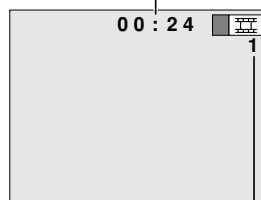

Remaining number of video clips possible
(Video clip shooting screen)

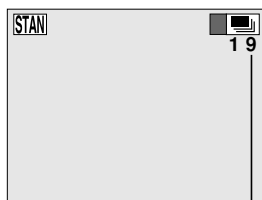

Remaining number of images possible
(Sequential shot shooting screen)

CHECKING THE REMAINING NUMBER OF IMAGES, VIDEO RECORDING TIME, AND AUDIO RECORDING TIME

Checking the Remaining Audio Recording Time

1 Display the Shooting Option Setting Screen (see page 29).

- Set the selector dial to .
- Select "AUDIO REC."



2 Press the SET button.

- The Audio Recording Screen appears, and the remaining recording time appears in the top of the LCD monitor and the remaining number of recordings appears in the upper right of the LCD monitor.

Remaining recording time (min:sec)

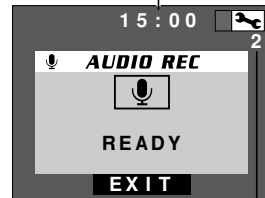

Remaining number of recordings possible

CONCERNING IMAGE AND AUDIO DATA STORAGE

Saving the Images Captured with Your Digital Camera

● Saving the images to a computer

Requires: Computer connecting cable (supplied), commercially available personal computer.

Advantages: The images are saved as data on the computer hard disk. They can then be processed or edited, sent over a network or the Internet, etc.

● Print out in high quality with a digital print service

For high-quality print outs of your captured images, you can take your image data to digital print service centers for digital cameras (see page 113). Network print services are also available for access if necessary.

Advantages: You can receive high-quality printouts of the images you capture.

Caution: To print out a single shot from a sequential shot or a single scene from a video clip, you must first copy the data as a still image (see page 112).
If the image resolution is low, depending on the print size, the output image may not be high quality.

Data File Formats

The format of the files saved on the card and the method in which the file names are determined are explained below.

Still image data

Data format: JPEG or TIFF format (Design rule for Camera File system compliant)

File name structure: SANY0000.jpg or SANY0000.tif
The "0000" represents a sequential number assigned automatically.

Voice memo data

Data format: WAVE format

File name structure: SANY0000.wav
The "0000" represents the same sequential number as the image file to which the sound memo corresponds.

Sequential shots data

Data format: JPEG format

File name structure: SEQTxyy.jpg
The "xx" represents the folder number where the sequential shots are stored. The "yy" represents a sequential number assigned automatically.

CONCERNING IMAGE AND AUDIO DATA STORAGE

Video clips data

Data format: QuickTime Movie format
File name structure: VCLP0000.mov
The "0000" represents a sequential number assigned automatically.

Audio recording data

Data format: WAVE format
File name structure: SUND0000.wav
The "0000" represents a sequential number assigned automatically.

Configuration of Directories for the Stored Data

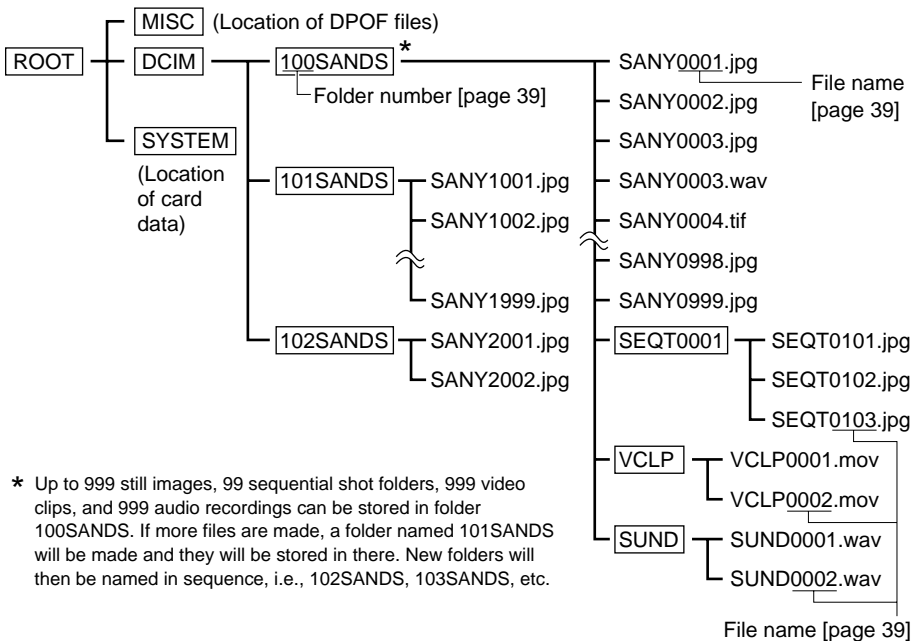

NOTE

Do not modify the folders and file names in the card using your computer

- If the folders, file names, or their configuration is modified by accessing the card using a commercially available card adaptor, it will be impossible to playback the data using the digital camera, and the digital camera may not operate properly.

Concerning the video clip data saved by the digital camera

- You can use QuickTime Ver. 3.0 or greater from Apple to playback the video clips. QuickTime 4.1 Pro for Windows and Macintosh is supplied with the SANYO Software Pack.
- To view images using MediaPlayer on a computer running Windows, use the software included in the SANYO Software Pack (supplied) to change the images to the Windows-compatible AVI format.

Free Manuals Download Website

<http://myh66.com>

<http://usermanuals.us>

<http://www.somanuals.com>

<http://www.4manuals.cc>

<http://www.manual-lib.com>

<http://www.404manual.com>

<http://www.luxmanual.com>

<http://aubethermostatmanual.com>

Golf course search by state

<http://golfingnear.com>

Email search by domain

<http://emailbydomain.com>

Auto manuals search

<http://auto.somanuals.com>

TV manuals search

<http://tv.somanuals.com>