

Network

L C D P r o j e c t o r

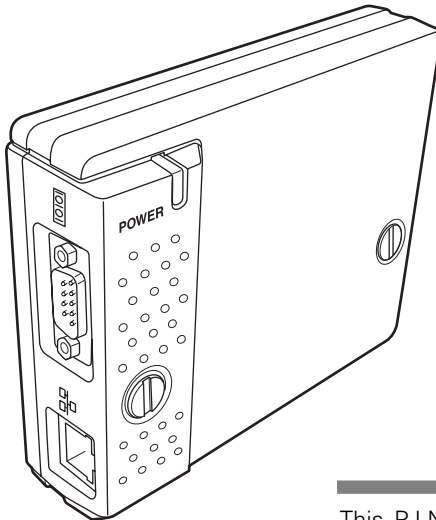

PJ-Net Organizer[®] *plus*

Model No. POA-PN02

Chapter 1 Preparation

Chapter 2 Installation

Chapter 3 Basic Setting & Operation

Chapter 4 Controlling the Projector

Chapter 5 Network Capture & Viewer

Chapter 6 Controlling the Multi-Projectors

Chapter 7 Use of Serial Port

Chapter 9 Appendix

This PJ-Net Organizer is an optional network product for the projector. Mount this product to the projector and connect a network cable. It enables a projector to display the image data stored in the file server and the screen image of the computer via the network. In addition, you can control and set up the projector remotely by using the web browser.

This product is only used for SANYO projectors that have a terminal for the PJ-Net Organizer.

This manual explains the installation of the PJ-Net Organizer and its operation.

OWNER'S MANUAL

Compliances

Federal Communication Commission Notice

This equipment has been tested and found to comply with the limits for a Class B digital device, pursuant to part 15 of the FCC Rules. These limits are designed to provide reasonable protection against harmful interference in a residential installation. This equipment generates, uses and can radiate radio frequency energy and, if not installed and used in accordance with the instructions, may cause harmful interference to radio communications. However, there is no guarantee that interference will not occur in a particular installation. If this equipment causes harmful interference to radio or television reception which can be determined by turning the equipment off and on, the user is encouraged to try to correct the interference by one or more of the following measures:

- Reorient or relocate the receiving antenna.
- Increase the separation between the equipment and receiver.
- Connect the equipment into an outlet on a circuit different from that to which the receiver is connected.
- Consult the dealer or an experienced radio/TV technician for help.

Use of shielded cable is required to comply with class B limits in Subpart B of Part 15 of FCC Rules.

Do not make any changes or modifications to the equipment unless otherwise specified in the manual. If such changes or modifications should be made, you could be required to stop operation of the equipment.

Model Numbers : POA-PN02

Trade Name : Sanyo

Responsible party : SANYO FISHER COMPANY

Address : 21605 Plummer Street, Chatsworth, California 91300

Telephone No. : (818)998-7322

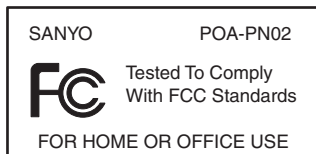

CAUTION ON USE IN NETWORK

- When you receive an alert e-mail from the projector, you must check the projector immediately. Fire or accident may result if the projector is used in an abnormal condition.
- When you install the projector at remote location and use it through the network, you must perform the safety inspections periodically. In this case you must pay attention to the change of environment in which you installed the projector. It may cause fire or an accident depending on the change of environment.

CAUTION

SANYO Electric Co. Ltd assumes no responsibility for the loss or damage of data or damage of the computer caused by use of this product.

Contents

Chapter 1 Preparation	5
Features	6
Operating Environment	9
Before use	10
Software License Agreement	12
Chapter 2 Installation	13
Flow of installation	14
Name and function of each part	15
Installation and Network configuration	16
Mounting	16
Connection of LAN cable	17
Network configuration	18
Password setting	20
Notice about system construction	21
Installing the software	22
Network Viewer & Capture installation	22
Installed software	23
File Converter 2 Installation	24
Installed software and places	24
Chapter 3 Basic Setting and Operation	25
Login the setting page of the projector	26
1 Enter the IP address	26
2 Select a display mode and login	26
3 Display of main setting page	27
Initial Settings	29
1 Language Setting	29
2 Password Setting	30
3 Temperature unit setting	30
4 Date/Time Setting	31
Network Configuration	32
1 Configure the network	32
2 Name the projector	32
E-mail Setting	33
Examples: Type and contents of alert mail	35
Chapter 4 Controlling the Projector	37
Power on/off the projector	38
Check the status of projector	39
Control the projector	40
Input	41
PC Adjustment	42
Save a Set	43
Load a Set	43
System Adjustment	44
Image Adjustment	45
Save an image adjustment value	46

- Load an image mode46
- Screen47
- Sound47
- Setting48
- How to set the Timer50
- Check the Timer events51
- Cancel the timer52
- Service53
- Save Actual Adjustment54
- Check the Save items55
- Control the projector's menu57
- Make a memo58
- Chapter 5 Network Viewer & Capture59**
 - Using the Network Capture function60
 - Launching the Network Viewer60
 - Parameter Determination60
 - Advanced using example64
 - Create the available data [File Converter]65
 - [1] How to use the Network Viewer (File Converter 1)65
 - Converting procedure66
 - [2] How to use the Network Viewer (File Converter 2)68
 - Conversion procedure68
 - Making a program file [Program Editor]69
 - Procedure of making program69
 - Using the Network Viewer function72
- Chapter 6 Controlling the Multi-Projectors79**
 - Multi-Control80
 - Register IP address and projector name81
 - Check IP address and projector name81
 - Exclude/Add/Delete a projector82
 - Control83
 - Load and apply the setting value83
- Chapter 7 Use of Serial Port85**
 - Serial Port setting86
 - Control Examples88
 - Use of Telnet90
 - Control the projector with Telnet92
- Chapter 8 Appendix:A93**
 - Examples of Connection94
 - Web browser setting96
 - Product specification101
 - FAQ104

Chapter 1 Preparation

1

ENGLISH

Features

Network Capture function

It enables a projector to project the screen image of the computer on the screen via the network by using an exclusive utility software .

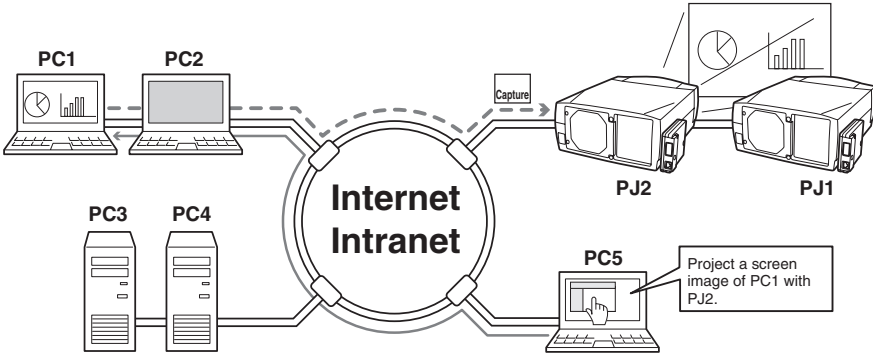

Network Viewer function

The projector receives the image data stored in the file servers in the network and displays images automatically.

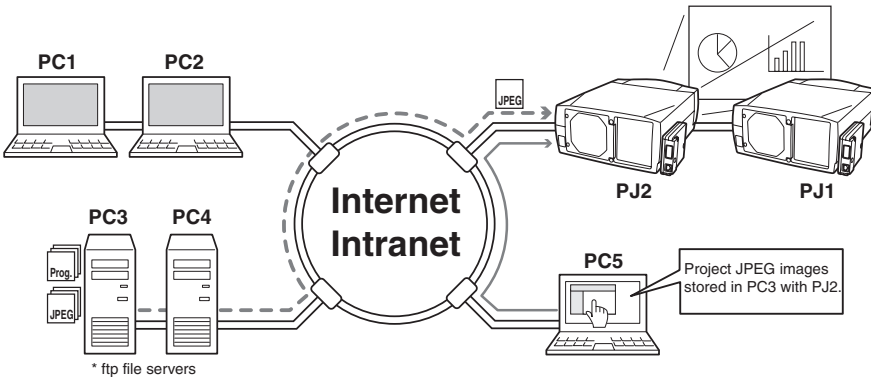

Web Management function

With this function, you can monitor projector functions such as power status, lamp status, input mode, signal condition, lamp-use time, etc. through the network by using the web browser installed on your computer.

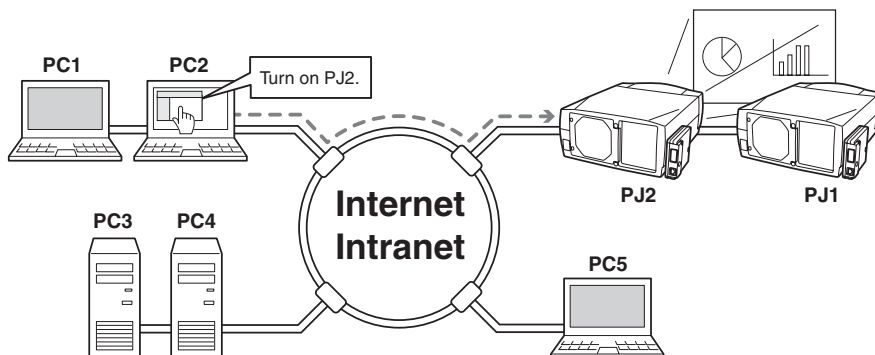

E-Mail Alert function

The projector (Network Unit) sends messages to the registered e-mail addresses when a lamp abnormality or power failure occurs with the projector. This message describes how to solve the cause of the problems. You can take efficient action for quick recovery.

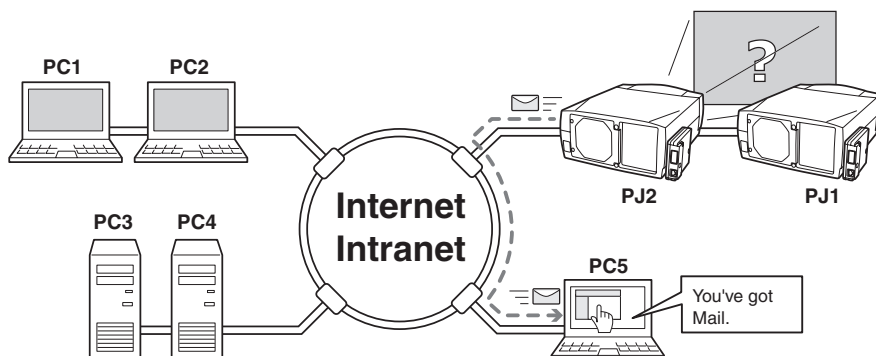

Multi-control function

A single computer can control and set up the multiple computers at the same time.

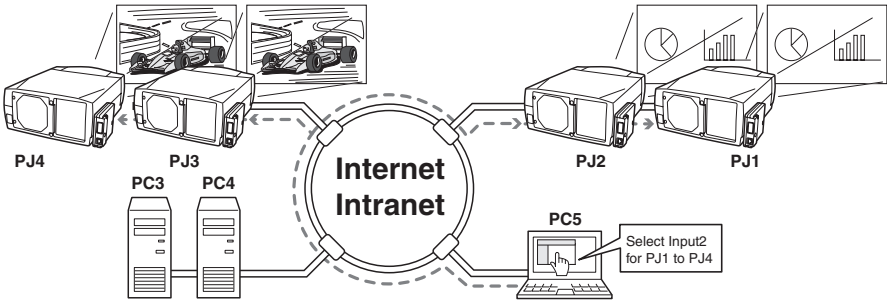

Automatic On/Off using Clock function

Automatically turn on or off the projectors at specified date/day and time by using the clock function.

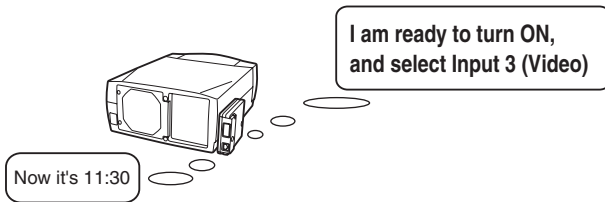

Control port ready for external equipment via network

This product provides a serial port (RS-232C) for controlling external equipment. By connecting the equipment which has a serial port, it can be controlled by a computer via the network. * This product does not provide the interface driver software to control external equipment.

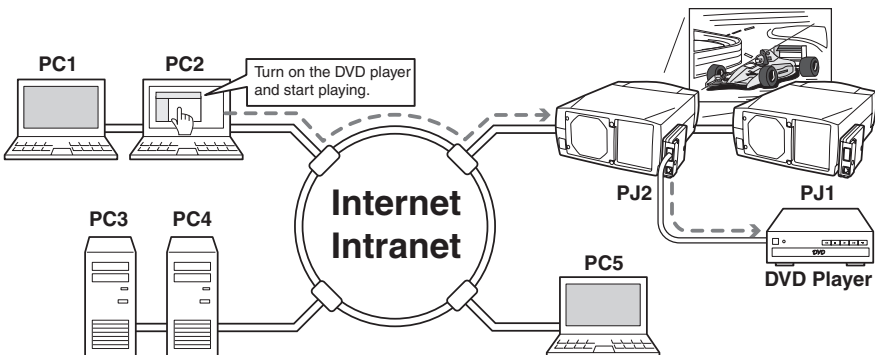

Operating Environment

To perform the managing and setting of the projector by using this product, the environment described below is required.

Network

Network must handle Ethernet correctly and accept TCP/IP and FTP protocol.

Operating System

Windows 98 / Windows 2000 / Windows Me / Windows NT4.0 SP6 / Windows XP

Computer system requirements

- Computer with 900 MHz or higher processor clock speed recommended;
 - * Intel Pentium/Celeron family or compatible processor recommended
- 128 MB of RAM or higher recommended (64 MB minimum supported)
- 100 MB of available hard-disk space
- VGA or higher-resolution video adapter and monitor
- CD-ROM drive
- 10Base-T or 100Base-TX network card

Web browser application*

- Microsoft Internet Explorer version 5.0, 5.5 or 6.0.
 - Netscape Navigator version 6.1, 6.2 or 7.0.
- * Used to control and set up the projector. The layout of pages in the browser may slightly differ from each type of application or operating system you use.

Internet mail application*

- Microsoft Outlook
 - Microsoft OutlookExpress
 - Netscape Mail
- * Required the internet e-mail application software to receive an e-mail alert sent from this product. If you do not use the function E-mail Alert, this application is not required.

File service*

- ftp server (Windows 2000 Professional or Windows XP Professional)
- * The ftp service provided with the Windows 2000 Professional or Windows XP Professional is required when using the Network Viewer function.

The limitation^{*1} of connection between this product and Hub or Computer

Suitable LAN cables are limited by length and type as follows;

Connection	Type of usable LAN cable	Maximum length
Network Unit - Hub	UTP Straight Cable with category 3 or 5 * ²	100m
Network Unit - Computer	UTP Cross Cable with category 3 or 5* ²	100m

*1 There may be other limitations depending on your network environment or LAN specification. Please consult your network administrator for further details.

*2 Category of LAN cable indicates the cable quality. Normally, a cable with category 3 or 5 is used for 10Base-T network, and a cable with category 5 is used for 100Base-TX network.

Before use

Package contains

The package contains following items. Check each item as you unpack the package. If you have any of the following items missing, contact the sales dealer.

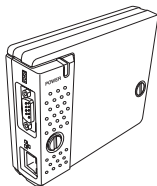

Network unit 1 piece

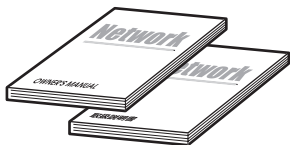

Owner's manual English/Japanese 1 piece each

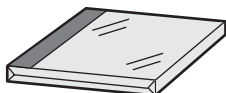

CR-ROM 1 piece

Expression/Abbreviation

The word “projector” found in this manual means “projector provided with Network Unit” unless otherwise noted.

The OS of the computer and the Web browser described in this manual is Windows XP Professional and Internet Explorer 6.0. In case of another OS or Web browser, some instruction procedures may differ from the actual operation depending on your computer environment.

Use of this manual

This manual does not provide the description of basic operation and functions for computer, web browser, projector and network. For instructions about each piece of equipment or application software, please refer to the respective booklet.

Trademarks

PJ-Net Organizer is a registered trademark of SANYO Electric Co., Ltd. Ethernet is a registered trademark of Xerox Corporation. Microsoft, Windows, Windows NT are registered trademarks of Microsoft Corporation. Internet Explorer is a registered trademark of Microsoft Corporation. Netscape Navigator and Netscape Communicator are trademarks or registered trademarks of Netscape Communications Corporation. JavaScript is a registered trademark of Sun Microsystems, Inc.

Other product or brand names in this manual are registered trademarks or trademarks of their respective owners.

- * Unauthorized use of a part or whole of the contents in this manual is prohibited.
- * The contents of this manual are subject to change without notice.

Software License Agreement

Before using Network Viewer & Capture Software CD-ROM, thoroughly read the following software license agreement to fully understand its contents.

Use this CD-ROM only when you agree to the terms of this agreement.

If you do not agree to the terms, do not use this CD-ROM.

Software License Agreement

This is a legal agreement between the customer (hereafter referred to as "user") and Sanyo Electric. Co Ltd. (hereafter referred to as "our company"). Both parties accept the following terms on use of this software product (hereafter referred to as "software") that our company grants to the user the right to use the software.

Article 1 Definition of software

"Software" in this agreement includes computer software contained in this CD-ROM.

Article 2 Grant of license

Our company grants to the user the non-exclusive right to use the software on the following terms and conditions stated in this agreement.

Article 3 Duplication of software

The user may not duplicate all or a part of the software except that the user may make a copy of the software for backup purpose.

Article 4 Modification of software

The user may not decompile, disassemble, reverse engineer, or in any way modify the program code of the software.

Article 5 Proprietary right and copyright

All of the copyright and proprietary right of the software and its copies belong to our company.

Article 6 Prohibition of regrant and transfer of the license to any third party.

The user may not transfer the program or its copy to any third party without the express written permission from our company, or may not transfer or regrant the right to use the software.

Article 7 Contract term

This contract will commence on the date when the user starts using the software and shall be effective until the user finishes using the software.

However, our company shall have the right to deprive the user of the right to use the software and terminate the contract if the user is in the material breach of any term of this agreement.

Article 8 Obligations after contract termination

When the user terminates the contract, the user shall be responsible for making the software obsolete and dispose of it so that a third party cannot re-use it. The user shall also dispose of all duplicated or modified software and all documented materials about the software.

Article 9 Responsibilities of our company

In no event will company be liable to the user for direct, incidental or consequential damages, or other property damages, such as data and program damages, including any loss of profits or lost savings arising from use of the software made by the user.

Chapter 2 Installation

2

ENGLISH

Flow of installation

The following are instructions for attaching this product to the projector and connecting it to the network. Please review the entire procedure to become familiar with it.

1 Function of the Network Unit (☞ p.15)

Explains the name and functions of each part of the network unit.

2 Installation and network configuration (☞ p.16-21)

- 1** Mount this product onto the projector.
- 2** Connect the LAN cable and join it to the network.
- 3** Configure the network of the network unit.
- 4** Set the password.

3 Installation of the software (☞ p.22-24)

Explains how to install the software Network Viewer & Capture into your computer.

Set up is completed.

The preparation is completed to control the projector connected to the network. At next step, set up and control the projector via the network by using the web browser installed on your computer. Please see chapter 3 "Basic setting and operation". (☞ p.25)

1 Name and function of each part

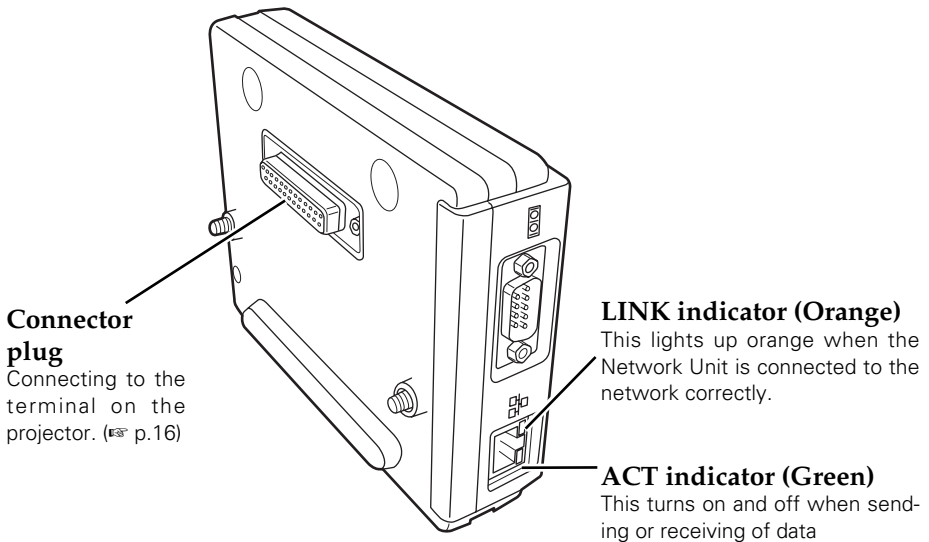
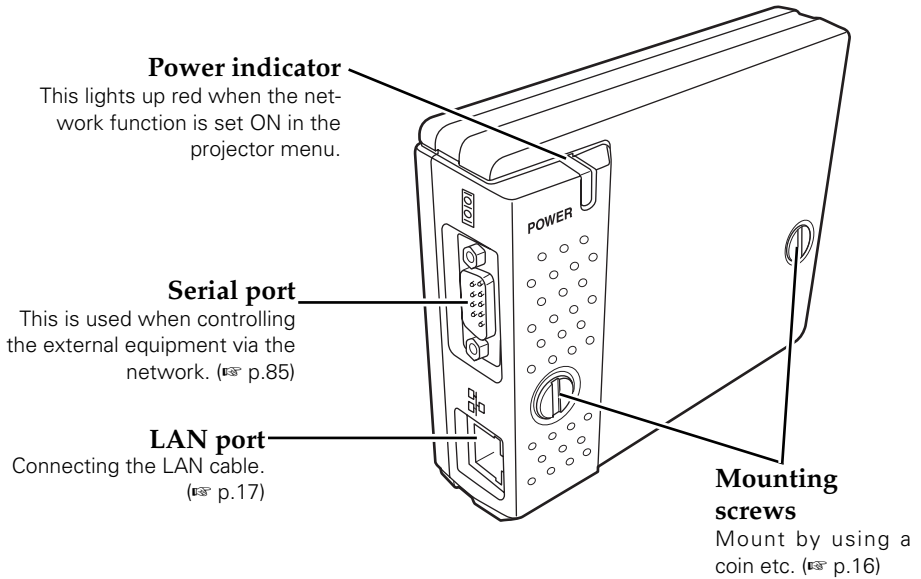

2 Installation and Network configuration

Mounting

1 Disconnect the AC plug from the projector.

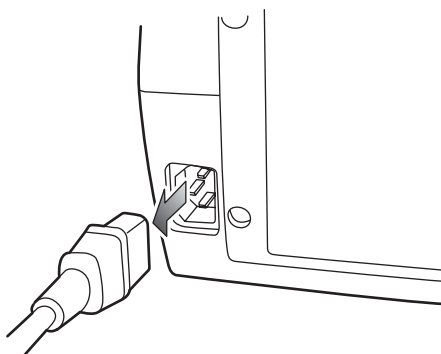

2 Remove the connector cover and screw covers from the projector and insert plug on this product to the option connector.

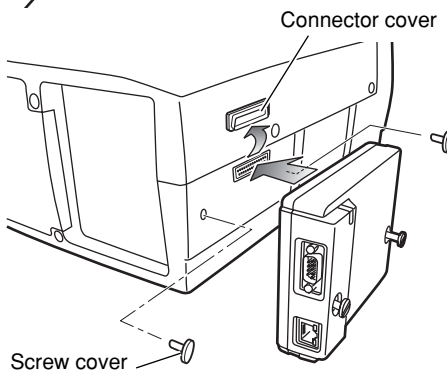

3 Tighten two screws by using a coin etc.

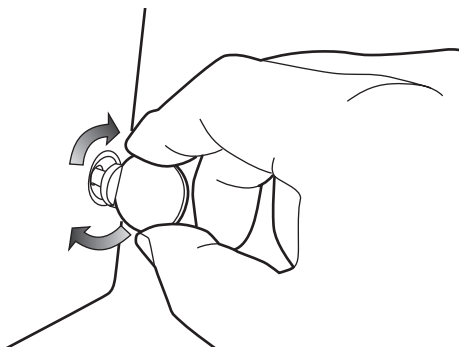

⚠ Caution

- ☞ The AC cord must be disconnected when mounting or removing this product otherwise it may damage the product.
- ☞ Do not connect the AC cord until after connecting the LAN cable and computer.

Connection of LAN cable

To connect to the network, it is required to use the UTP (Unshielded Twisted Pair) strait cable with RJ-45 plug. There are two different types of cables depending on whether the network is constructed with 10Base-T or 100Base-TX. Prepare the Hub (10Base-T or 100Base-TX) to distribute the network cable if required.

1 Disconnect the AC plug from the projector.

2 Connect the UTP strait cable to the LAN port on the Network Unit.

3 Connect the UTP strait cable to the hub.

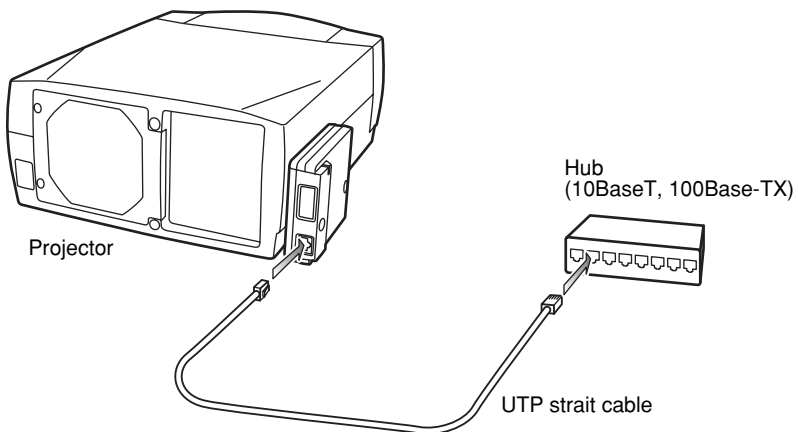
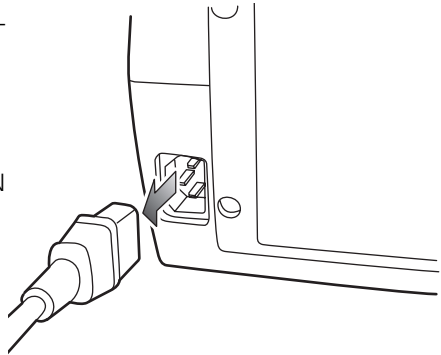

- ☞ Use the UTP cross cable when you connect the computer and projector directly not using the hub.
- ☞ When you connect the projector into the 10Base-T network, use cable with category 3 or 5. When you connect the projector into the 100Base-TX network, use cable with category 5.
- ☞ The length of cable between hub and projector should be less than 100m.

Network configuration

Confirmation of the network menu

When installing this product to the projector, the network on-screen menu items for this product are activated automatically. If not activated, the product may not have been installed correctly. Please check item "Mounting" (p.16).

Configure the network

When you connect the projector to the network, the network number of projector must be the same as the network you intend to connect. You should configure projector's network first.

This example explains how to set the following configuration.

IP Address	: 192.168.1.201
Subnet Mask	: 255.255.255.0
Default Gateway	: 192.168.1.1
DNS	: 0.0.0.0

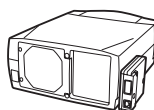

The default network configuration is set as follows.

IP Address	: 192.168.0.2
Subnet Mask	: 255.255.255.0
Default Gateway	: 0.0.0.0
DNS	: 0.0.0.0



1 Selection of network menu [Network]

Turn on the projector and display the menu on the screen. Select the **Network setting** icon from the main menu using the point buttons (▼▲◀▶). From the submenu, select **Network setting** sub icon, then press **SELECT** button once. Check that the mode is "On". If not, change mode to "On" using the point buttons ◀▶.

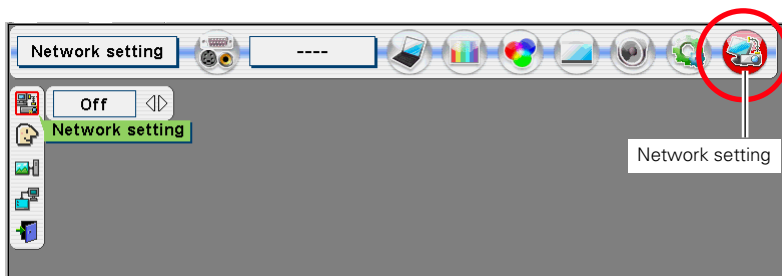

* The above on-screen display may differ from the actual display depending on the functions of the projector you use.

2 Configuration for IP Address/ Sub net/ Gateway*/DNS*

Press **SELECT** button again, the following network setting menu appears on the screen. Enter the specified network address.

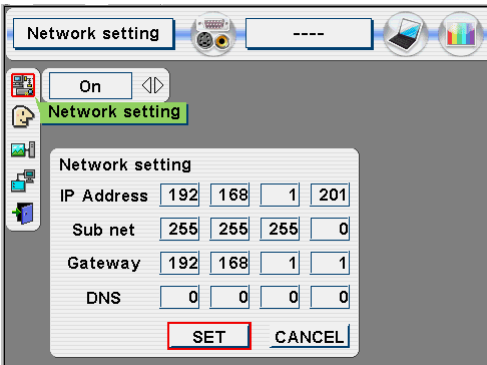

How to enter the numbers

There are 2 ways to enter the numbers, one is by using the point buttons (▼▲◀▶) on the remote control handset or on the projector, the other is by using the screen 10-key pallet by which the numbers can be entered directly. For further information see next page.

3 Restart the Network Unit

Select **Set** with ◀▶ keys and press **SELECT** button again. The network configuration display disappears and the network unit begins restarting. It takes about 40 seconds. Do not turn off the mains switch during this period.

Completing of installation

Now the installation is completed. The IP address of this projector is set to "192.168.1.201".

* In the network environments not using a Gateway or Router, the Default Gateway address should be set to [0.0.0.0]. If you do not use the functions E-mail or DNS server, it is also set [0.0.0.0] for the DNS address.

Password setting

A password can be set to restrict access to the setting pages of the projector using the web browser. The default password is set "0000" as no password.

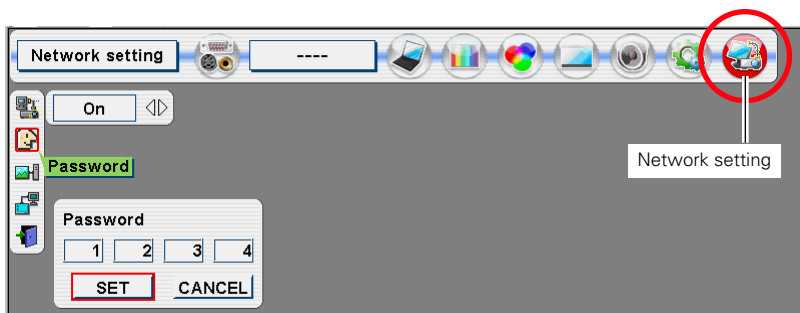

- 1 Use the projector's menu and select the **Network setting** icon on the menu.
- 2 Select the **Network setting** sub icon from the submenu, and then press **SELECT** button once. Check that the mode is "On".
- 3 Select the **Password** sub icon and then press **SELECT** button once.
*The setting window appears. The numbers on the display indicates the current password.
- 4 Enter your desired number by using the point buttons on the projector or remote control handset, and then select **Set** and press **SELECT** button.
*The password setting window disappears and the network unit begins restarting. It takes about 40 seconds. Do not turn off the mains switch during this period.
*The password can be entered by using the screen 10-key pallet (P.21).

How to enter the numbers with point buttons

To move the selection and change the value, use the point buttons (▼▲◀▶) on the projector or on the remote control handset.

The point buttons ◀▶ are used to select the column.

The point buttons ▼▲ are used to change the numbers up and down.

- ✎ Password setting must be done when you connect the projector to the network. This setting is carried out through the projector's menu and also it can be set through the network using the web browser. For further information please refer to item "Initial Setting/Password setting" (P.30).
- ✎ Valid characters for password are only 4 digits numeric numbers 0 to 9. The number "0000" means no password set.
- ✎ This password is not to restrict the use of the projector. This password is to set the security against the use of the projector through the network.

How to enter the numbers with the screen 10-key pallet

1. Select a column with a red frame by using the point buttons ◀▶.
2. Press SELECT button. The screen 10-key pallet appears on the screen.
3. By using the point buttons (▼▲◀▶), select numbers 0 to 9 and press SELECT button. By repeating the above to enter the complete number on the column.

*To change the number in a column, select "C" and press SELECT button to clear the number in the column and then enter the number again.

4. After entering the number in the column, select a move key (◀▶▲▼) located on the lower part of the pallet by using the point buttons and press SELECT button repeatedly to move the red frame.
5. Repeat steps 3 to 4 for entering all the network address.
6. After finishing, select "Exit" and press SELECT button. The 10-key pallet disappears on the screen.

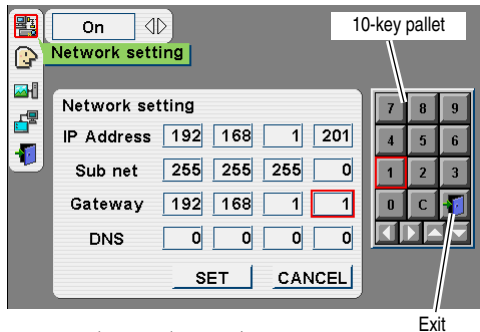

Notice about system construction

For installation of multiple projectors into the same network with Network Unit.

Do not install multiple projectors with Network Units that have their default network settings to the same network. The use of the Network Units which have the default IP address set to the same network settings will cause IP addresses to collide and create a malfunction. When you install multiple projectors into the same network, configure the network with the following steps.

1. Change the IP address from the default IP address. To change the IP address, use the network setting menu on the projector. Please see item "Network Configuration" for further information (p.18).
2. Make sure that there is no network equipment set with the same IP address in the network before connecting to the network.
3. When installing other projectors, follow the above steps to change the IP address and connect to the network.

In case of installing the projector with Network Unit into the network constructed with the DHCP/BOOTP server.

This Network Unit does not support the DHCP/BOOTP server. The static IP address must be manually configured. To use this product in this network environment, set it up so that the DHCP/BOOTP server does not assign the IP address configured to this product for another device on the network. Please consult your network administrator for further information.

3 Installing the software

It is required to install the software into your computer to use the Network Capture function and Network Viewer function. Please install the following procedure.

Note:

To install the software into the computer with Windows 2000, Windows XP or Windows NT, you should login with administrator rights. Before installation, make sure that the other applications are closed, otherwise proper installation cannot be made.

Network Viewer & Capture installation

- 1 Set the supplied Network Viewer & Capture CD-ROM into the CD-ROM drive of your computer. Double click **SetupTool.exe** icon in the "Tool" folder in the CD-ROM.
- 2 Select "English [United States]" from the pull-down menu on the "Choose Setup Language" window and click **OK** button to start installing and then follow the installation wizards.

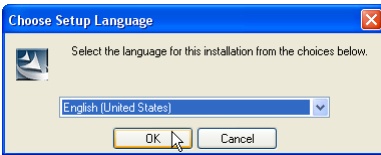

As the "Software License Agreement" will appear, read contents carefully and click **Yes** button if you agree the license agreement to proceed with installing.

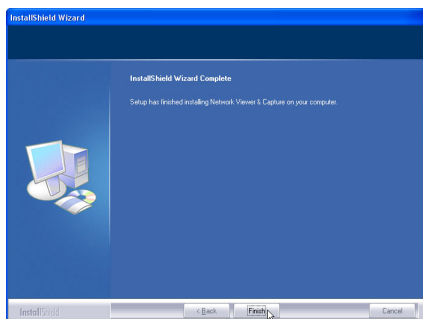
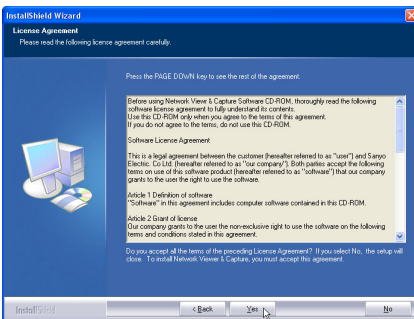
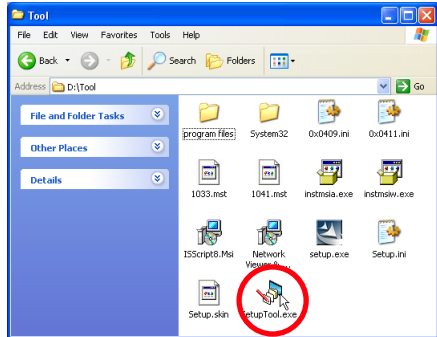
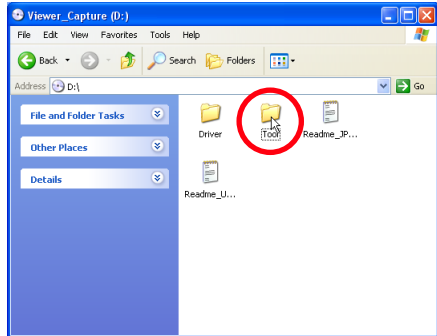

Installed software

The following 3 software are installed on your computer.

● Network Capture:

Capture the displayed image of the computer and serve it to the projector via the network.

This software is registered into “startup folder” of the computer and the capture icon stays on the task bar after booting the computer.



Capture icon

● Network Viewer (File Converter 1):

Converts the JPEG*1 data format which can be projected with the projector from the JPEG and BMP files.

● Network Viewer (Program Editor) :

This is a tool to make the programs which has a function to specify and order the projecting JPEG image data stored in the file servers.

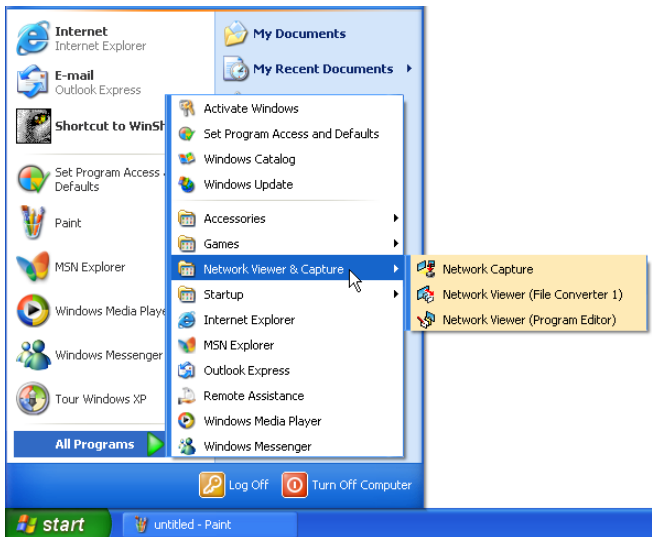

* To uninstall these software, use “Add/Remove Program” from the control panel.

*1 The data which can be projected by the projector is the JPEG format based on the ISO/IEC 10918.ITU-T recommendation T.81. There are several kinds of JPEG formats. To project the JPEG images by using the Network Viewer function of the projector, the files need to be converted to the optimized JPEG file by using the File Converter application software previously.

File Converter 2 Installation

- 1 Set the supplied Network Viewer & Capture CD-ROM into the CD-ROM drive of your computer. Double click **SetupDrv.exe** icon in the "Driver" folder in the CD-ROM.
- 2 Select "English [United States]" from the pull-down menu on the language selection window and then click **Install** button to start installing.

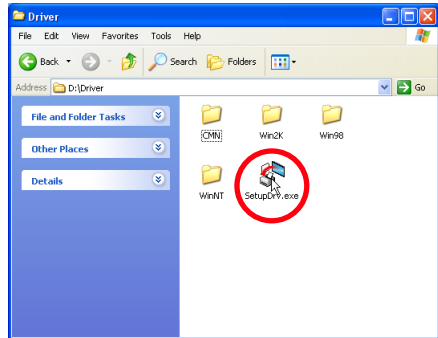
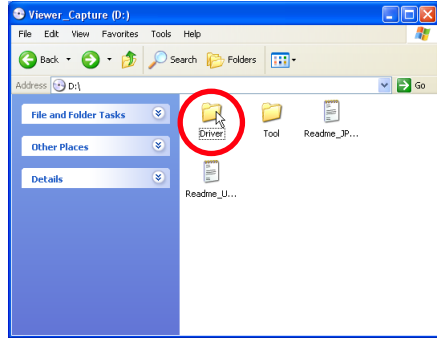
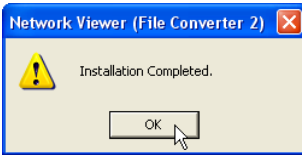
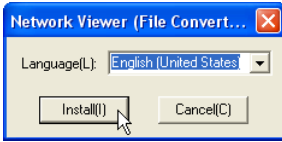

Installed software and places

Network Viewer (File Converter 2) is installed in the "Printers and Faxes" folder in the "Control Panel".

- **Network Viewer (File Converter 2):** This is a kind of the printer driver to convert to the JPEG data optimized to project by the projector from any of the documents created by the application software.

* To uninstall this software, just delete the "Network Viewer" icon from the "Printers and faxes" folder.

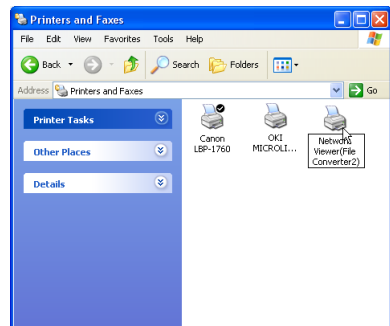

Chapter 3

Basic Setting and Operation

3

This chapter describes basic operations and settings for controlling the projector via a network using this product. It is required that computer and projector be connected to the network and the network address be properly configured.

Login the setting page of the projector

1 Enter the IP address

Launch the web browser installed in your computer, enter the IP address into the "Address" on the browser and the press "Enter" key.

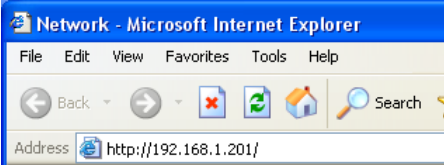

Enter the IP address that you configured in item "Network Configuration" (p.18). The default IP address is [192.168.0.2].

2 Select a display mode and login

This product provides 2 types of control mode, Graphic Mode and Text Mode as the below. Select a proper mode to match your PC and network environment by clicking on the text link.



Graphic Mode

Displays with 600 x 400 dots and the menus and settings with graphic icons. This mode is recommended for standard use.

Text Mode

Displays with 200 x 300 dots. This mode is optimized for use of the handheld computer, PDA, etc. It is also convenient if the network traffic is heavy.

If the setting page has set the password, the authentication window will appear. In this case type "user" onto the **User Name** text area and the login password onto the **Password** text area and then click **OK** button.

* The entering User Name must be "user" and it can not be changed.

[Note]

When accessing the projector at first time or setting the no password [0000], the auto-login will be performed and the next main setting page is displayed.



3 Display of main setting page

The following main setting page will be displayed according to your display mode selection. Perform the various kinds of setting through this page. Click on the menus to display the control and setting pages.

1 Main setting page in the Graphic Mode display

Setting page number
Browses pages by clicking the linked number.

Main menu
For selection of control and setting items of the projector.
(p.37)

Setting page
Displays the control and setting items according to the selected menu. The "Power & Status" page is displayed as the default.

* This graphic mode display is mainly used through this manual for the setting and control description.

2 Main setting page in the Text Mode display

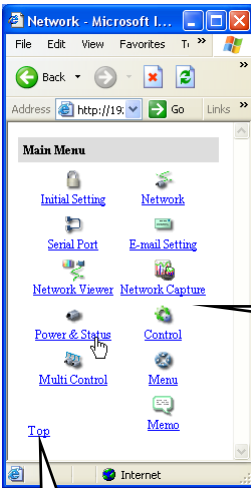

Main menu
For selection of control and setting items of the projector. Displays sub menu and status of selected items when clicking the linked text.

Returns to the display mode selection page.

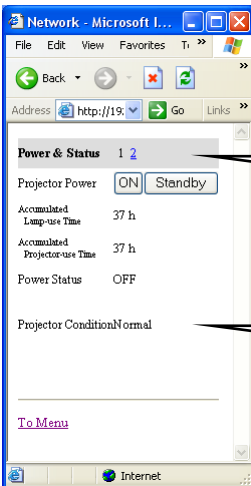

Setting page number
Browses pages by clicking the linked number.

Setting page
Displays the control and setting items according to the selected menu.

The network viewer function in the text mode has following limitation;

- Cannot select the program or folder for the display (☞ p.73)
- Cannot perform the registration, check or change of the program (☞ p.75-76).



Initial Settings

After installing this product to the projector, perform the following basic initial setting.

Click **Initial Setting** on the main menu to display the initial setting page.

The Languages, Date/Time, Password and Temperature unit can be set in this page. The model name of the projector on which this product is mounted is displayed on the page.

1 Language Setting

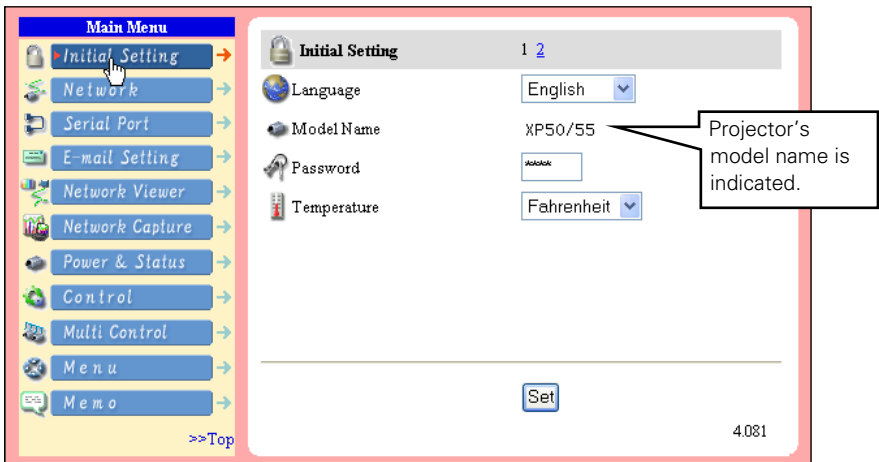

This setting is to select the display language of the web page. Select your language with the pull-down menu button and then click **Set** button. The selectable language is English or Japanese. You may find the unrecognized character text in the menu if the computer does not provide Japanese fonts.

[Note]

This language selection is realized by using the JavaScript function of the web browser. If the preference of the browser is set not to use the JavaScript, "Set" linked text appears on the page as the below. Click on its text to change the language display. There are various kinds of ways to change this preference depending on the web browser's version and application. Please refer to item "Appendix: Web browser setting/Active Script (JavaScript enable)".

(p.96)

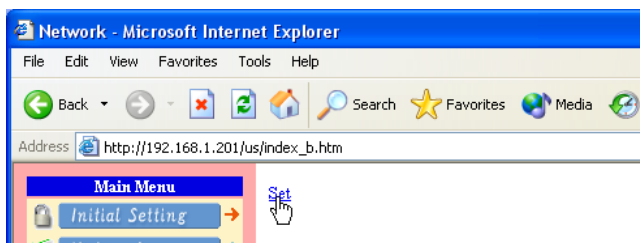

2 Password Setting

This page is to set the password to restrict the access from an unauthorized person through the network.

Enter the password onto the text box and click **Set** button.



The Network Unit begins restarting and it takes about 40 seconds. Close (Quit) the web browser and access to the login page again in 40 seconds. This is to perform the login authentication firmly.

The default password [0000] means no password. When you connect the projector with this product to the network, it is recommended that you set a new password. Only a four-digit numeric number is valid for the password.

* If you forget the password to the projector, you can check it by selecting "Password" sub menu from "Network setting" menu on the projector. For further information, please see item "Password Setting". (p. 20)

3 Temperature unit setting



Change the temperature unit displayed on the Power & Status page by using the pull-down menu.

Centigrade : indicated with °C

Fahrenheit : indicated with °F

*The projector icons shows the thermal sensors inside the projector. For further information see item "Check the status of projector" (p. 39).

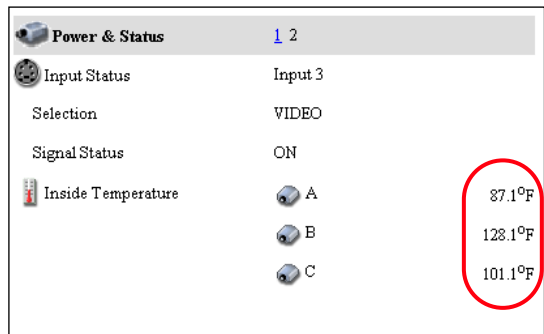

Caution

Use of Battery

This product provides a lithium battery. When the battery runs down, the clock and timer functions do not operate properly. Contact your local dealer for the replacement of battery. The replacement must be carried out by a qualified service personnel.

4 Date/Time Setting

Click on the page number "2" to display the Time Setting page.

Type present date onto the date text area with (Year/Month/Date) format and type present time onto the time text area with (Hour:Minute) format in 24 hours indication. Click **Set** button and confirm that the data and time are set correctly. The displayed date and time are not updated automatically, click the **Refresh** button to get the present date and time.

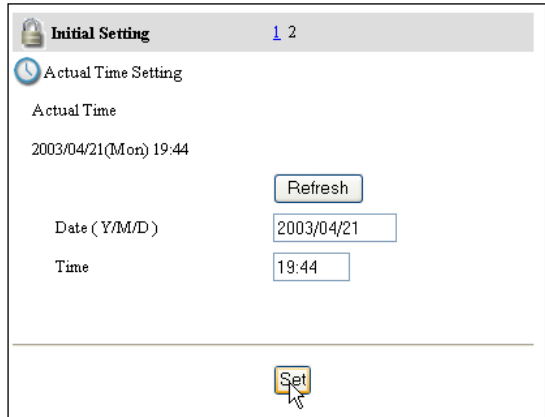

Initial Setting 1 2

 Actual Time Setting

Actual Time
2003/04/21(Mon) 19:44

Date (Y/M/D)

Time



Network Configuration

Click **Network** on the main menu. The following setting page is displayed. This page is to set the IP Address, Subnet Mask, Default Gateway, DNS (Domain Name Server) and projector name.

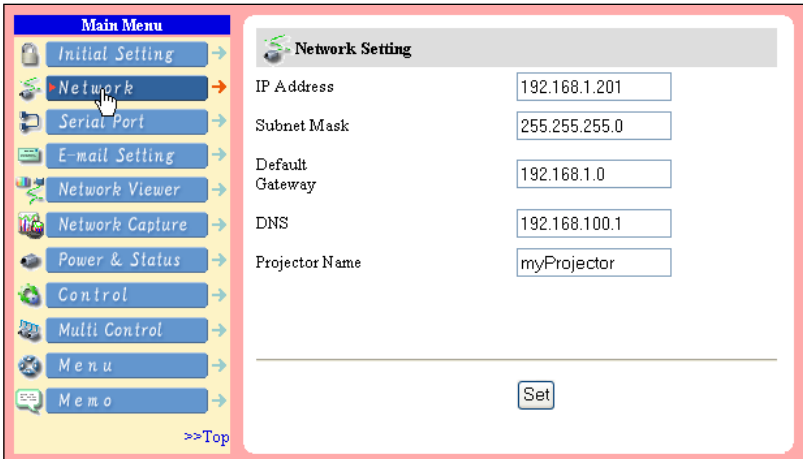

1 Configure the network

The IP address and Subnet Mask have been configured already in chapter "Installation". If you want to change them or configure default gateway*¹ or DNS*², perform them in this page. Enter an applicable address number onto each parameter and click **Set** button.

The Network Unit begins restarting and it takes about 40 seconds. Close (Quit) the web browser and access to the login page again in 40 seconds.

You must use the number specified by your administrator. The address must be entered as a group with four numbers split by a dot like [192.168.1.101].

2 Name the projector

You can name*³ the projector. By setting this name properly for the DNS server, the projector can be accessed by using this name instead of the IP address.

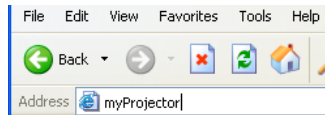

For further information, please consult your network administrator.

*1 Set [0.0.0.0] if the network does not provide the gateway (router).

*2 Set [0.0.0.0] if you do not use the function E-Mail alert.

*3 If you use the DNS server, register the host name registered to the DNS server as a projector name. You can access with this projector name from any computers in your network. If you do not use the DNS server, access with the assigned IP address to the projector.



E-mail Setting

This product has an E-mail function which can send an alert message to users or an administrator if it detects an abnormality on the projector or run out of the life span of the lamp. Click **E-Mail Setting** on the main menu and follow the below steps.

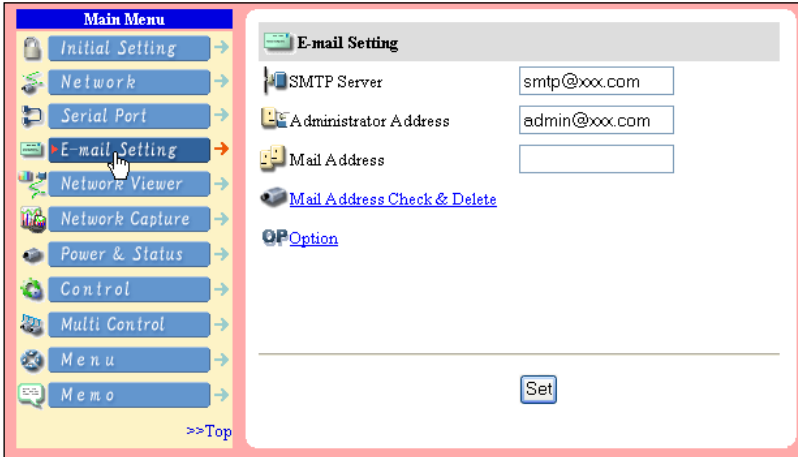

1 SMTP Server*1

Type the E-mail address of SMTP server and administrator and click **Set** button. The administrator address is set to "Reply-To" address sent from the projector.

*1 The SMTP server is a server for sending E-Mail. Please contact your network administrator to have this SMTP server address.

* If the network unit sends an alert message due to the abnormality on the projector but the SMTP server is down in some other reason, the message does not be sent. In this case, the message "Unable to connect to server." will be displayed on the setting page. Click **Set** button to remove the message.

- ☞ To use the E-Mail function, it must be set the DNS address on the Network setting page correctly.
- ☞ You cannot use this E-mail function if the DNS server and SMTP server cannot be used in your network environment. If the SMTP server is located in your LAN (Local Area network), the address set to SMTP server should be specified the in SMTP server located in your LAN. The server located outside of your LAN may not be available for security reason. For further information please contact your network administrator.
- ☞ Up to 10 E-mail addresses can be registered.

2 Registering and deleting E-mail addresses

Type the E-mail address onto the **Mail Address** text area and click **Set** button. To check the registered addresses, click on the **Mail Address Check & Delete** linked text. The addresses are listed as the figure on the right.

To delete the registered addresses, check the address you want to delete and click **Delete** button.

 [Mail Address Check & Delete](#)

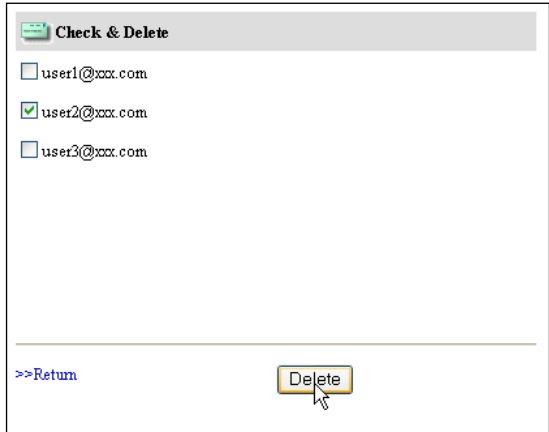

3 Option selection for sending alert message

Click on the **Option** linked text. Check the condition items under which alert messages will be sent and click **Set** button.

Please refer to item “Examples :Type and contents of alert messages” described on the next page.

 [Option](#)

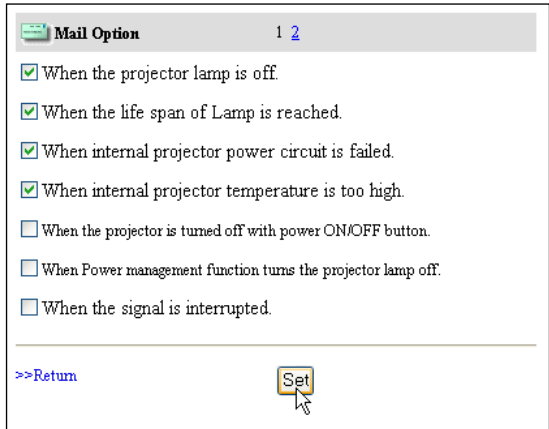

4 Condition selection for sending alert message

Check the condition items under which alert messages will be sent and click **Set** button.

A free message can be sent when the lamp use time reaches the preselected lamp use time.

Check this condition and enter a setting time. Type a free message on "Attached Message" text box and the click **Set** button.

* The length of message should be less than 256 characters.

* The lamp use time can be set 0 to 9999 hours.

If you check "When a connection error occurs during an auto play.", the projector sends an alert message when the error occurs while the projector projects images automatically by using the Network Viewer function (☞ p.72). For the detail of error contents, please see item "Auto display setting and control page[3]". (☞ p.74)

Examples: Type and contents of alert mail

When the projector has an abnormality, the following alert messages are sent to the registered E-mail address according to your selected condition. Administrator or user can take an efficient action quickly by receiving this message. This is very useful to maintain and service the projector.

The following are examples of received messages.

● When the internal temperature is too high:

```

TITLE: Message from projector
01-03-2003 00:59
Projector Model Name: XP50/55
TCP/IP: 192.168.1.201 Projector Name: myProjector

It sends you following message.

*The Projector lamp is turned off, because internal projector temperature is too high.
Wait Temperature Warning Indicator turned off,turn the Projector on again.
If the Indicator continues to flash,check the air filter for dust accumulation.

[A] 36.5 Degree [B] 46.5 Degree [C] 58.2 degree
Temperature of Sensor C is too high.
  
```

☞ The Network Unit let users know the information which thermal sensor [A], [B] or [C] inside the projector detected the abnormal temperature risen and so the projector was turned off. Please refer to item "Check the status of projector" for the location of the sensors [A], [B] and [C], and temperature (☞ p.39). Also see the owner's manual of the projector for further details.

● When the internal power circuit is failed:

TITLE: Message from projector
01-03-2003 00:59
Projector Model Name: XP50/55
TCP/IP: 192.168.1.201 Projector Name: myProjector

It sends you following message.

*The Projector lamp was turned off, because projector power circuit failed.
Unplug the projector from AC outlet and ask servicing to qualified service personnel.

- ☞ The Projector lamp was turned off, because the projector power circuit failed. Unplug the projector from AC outlet and ask servicing to a qualified service personnel.

● When the life span of lamp is reached:

TITLE: Message from projector
01-03-2003 00:59
Projector Model Name: XP50/55
TCP/IP: 192.168.1.201 Projector Name: myProjector

It sends you following message.

*The life span of lamp is reached.

- ☞ Replace it with a new lamp immediately and reset the lamp counter. If the projector is used without reset the lamp counter, the alert mail is sent to users in every power-on of the projector. This alert mail will not be sent when unchecking the mail sending condition "When the life span of lamp is reached".

● When the lamp use time reaches preselect lamp use time:

TITLE: Message from projector
01-03-2003 00:59
Projector Model Name: XP50/55
TCP/IP: 192.168.1.201 Projector Name: myProjector

It sends you following message.

*The lamp use time reaches 800 hours. Prepare the lamp replacement.

Free messages

- ☞ The Network Unit sends a free message when the lamp use time reaches the preselected lamp use time. It can be used for preparation of the lamp replacement and the maintenance required.

4

Chapter 4 Controlling the Projector

This chapter describes controlling the projector via a network using this product. Display the main menu following to the login procedure described on page 26.



Power on/off the projector

Click **Power & Status** on the main menu. The control page will be displayed. By clicking **On** or **Standby** button on the page, the power of the projector can be controlled. When you click **Standby** button, another confirmation popup window*1 will appear, and then click **OK** button if it is set to standby.

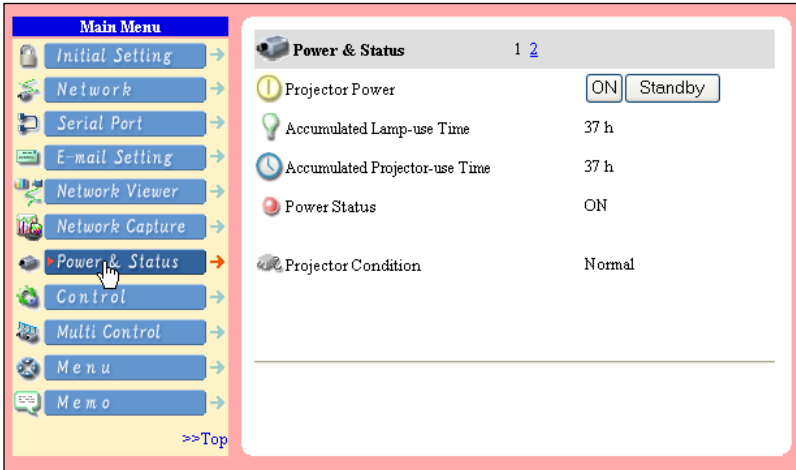

[Note]

*1 This popup window is realized by using the JavaScript function of web browser. If the preference of the browser is set not to use JavaScript, the popup window will not appear on the screen.

There are various kind of ways to change this preference depending on the web browser's version and application. Please refer to item "Appendix: Web browser setting/Active Script (JavaScript enable)" (p.96).

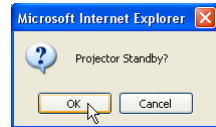

(JavaScript On)

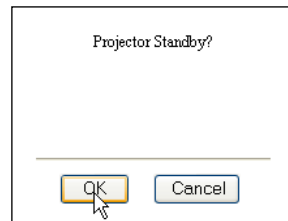

(JavaScript Off)

- The projector is not turned on for about 90 seconds after switching into the standby mode. After the power status indicator on the control page changes from "On Cooling down" to "OFF", then try to turn on the projector with **On** button.
- The web browser checks and updates the projector's condition every 20 seconds automatically.

Check the status of projector

In the "Power & Status" page, you can control the projector power, and also you can check the status of the projector as follows. To change the page, click on the page number linked text.

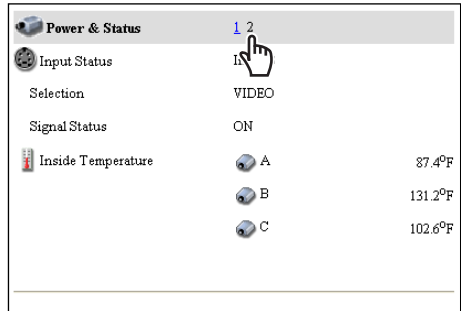
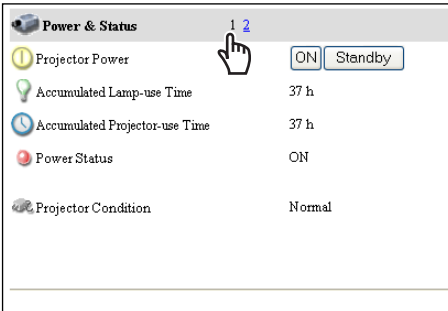

Items	Description
-------	-------------

Accumulated Lamp-use Time	Displays the accumulated lamp use time in hour units (h).
Accumulated Projector-use Time	Displays the accumulated projector use time in hour unit (h).
Power Status	Displays the status of the lamp.
Projector Condition	Displays the status of the projector's power.
Input Status	Displays the selected input mode.
Selection	Displays the source mode of selected input mode.
Signal Status	Displays the signal status of the selected input mode.
Internal temperature	Displays the temperature at internal thermal sensors in centigrade/ fahrenheit degrees. The icons [A], [B] and [C] on the page represent the thermal sensors located in the projector. If the temperature at one of those sensors exceeds specified temperature, the appearance of its icon changes to the following alert icon to let users know the abnormal temperature. Please check surrounding temperature of the projector, the clogged air filters and the area surrounding the ventilation fans.

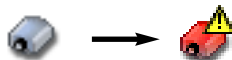

The icons [A], [B] and [C] represent the sensors located in the projector as follows:

- [A]: Surrounding temperature of the projector*.
- [B]: Surrounding temperature of the lamp.
- [C]: Surrounding temperature of the panel.

* The indicated peripheral temperature of the projector is a little higher than actual surrounding temperature.



Control the projector

The sub control menu appears on the lower side of the page when clicking **Control** on the main menu. When you click each control icon, the control page is displayed according to the control menu you selected. The setting method differs depending on the contents of the page. Click on the page number linked texts to change pages and select desired setting items.

✎ Please see the owner's manual of the projector to have the further information of each control item.

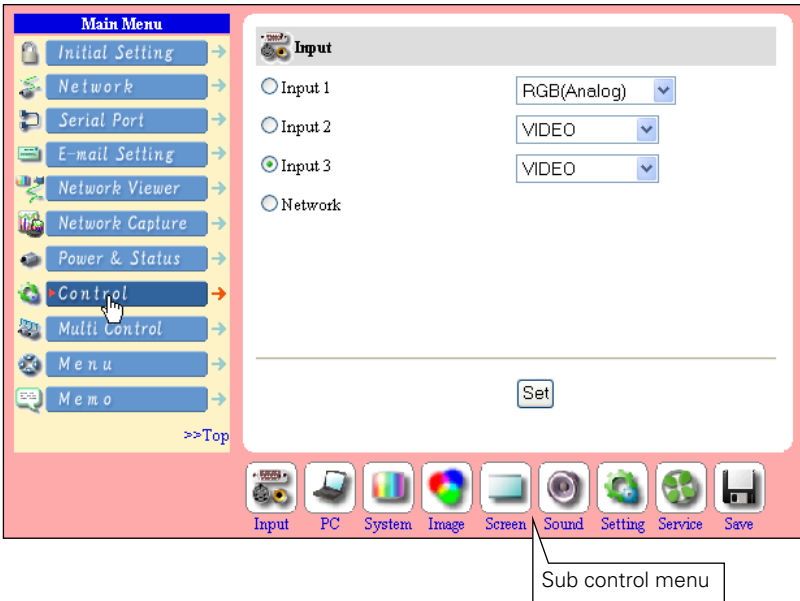

✎ The control page displays valid control items depending on the selected input mode, signal or functions of the projector you use, therefore, there may be different controls between the described items and actual control items on the page display.

✎ When the projector is in standby, only the timer on the setting menu is effective; others are inactive.



Input

This function is to select the input mode and source mode of the projector. Select the input mode with the radio button, and input source mode with the pull-down menu button. Then set the selected input mode and source mode by clicking **Set** button.

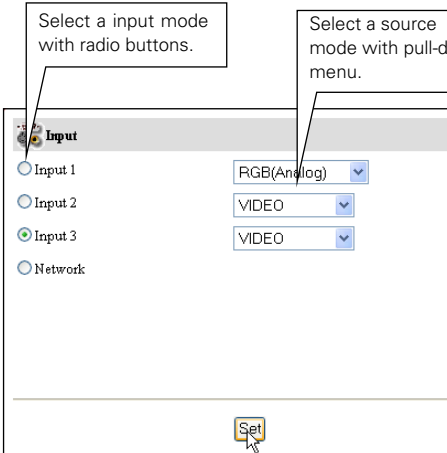

Item	Description
Input1	Available RGB(Analog), RGB(Scart), RGB(PC Digital), RGB(AV HDCP), Monitor out source mode.
Input2	Available VIDEO, Y,Cb/Pb,Cr/Pr, RGB source mode.
Input3	Available VIDEO, S-VIDEO, Y,Cb/Pb,Cr/Pr source mode.
Network	Using the Network Capture & Viewer function.



PC Adjustment

This function is to adjust the signal from the computer connected to the projector to obtain the proper picture image on the screen. Click on the page number linked texts to change the setting pages.

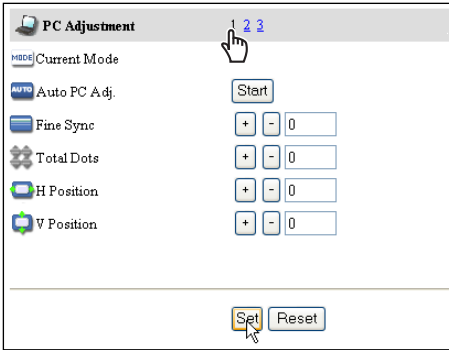

Item	Description
Current Mode	Displays current mode of the computer.
Auto PC Adj.	Performs automatic adjustment.
Fine Sync	Performs Fine Sync adjustment.
Total Dots	Adjust the number of total dots in the horizontal period.
Horizontal	Adjusts horizontal picture position.
Vertical	Adjusts vertical picture position.

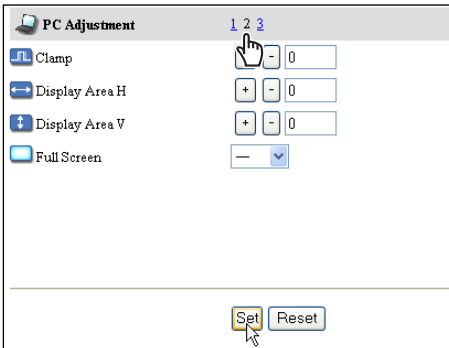

Item	Description
Clamp	Adjusts clamp position of the picture.
Display Area H	Adjusts the image area horizontally.
Display Area V	Adjusts the image area vertically.
Full Screen	Makes the image full screen display.

These parameters will appear only when the RGB(Analog) or Network input mode is selected.

Save a Set

- 1 Decide your desired PC adjustment values through the PC Adjustment pages "1" to "2".
- 2 Display the page "3" and select a mode number with the pull-down menu button of the **Save to**. Type a memo into the **Memo** text area for simply description of your selected number.
- 3 Register by clicking **Set** button.
To restore the adjustments, click **Reset** button.

The memos for Mode1 to Mode 5 are displayed with "Stored" or "Free". The memos for ExMode6 to ExMode50 can be stored with the input text.

Load a Set

Select a set to load with the pull-down menu button of the **Load Set No.** and click **Set** button. The stored setting values will be applied to the each PC adjustment item.

The PC adjustment settings can be stored up to 50 sets, 5 sets for Mode1 to Mode 5 are stored into the projector and 45 sets for ExMode6 to ExMode50 are stored into the network unit.



System Adjustment

This function is to select the color system of video signal or scanning system of component signal input to the projector. Select a system with the radio buttons to match the color system or scanning system of input source, and then click **Set** button. The displayed systems are switched according to the input mode.

Available selection when the VIDEO/S-VIDEO input

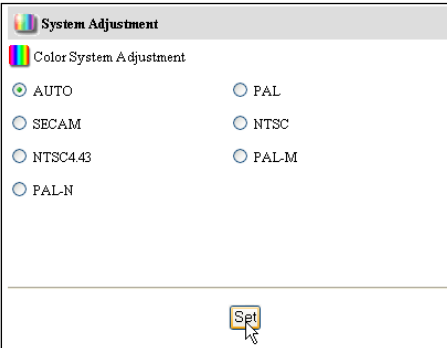

Item	Description
Color SystemSelects a color system of the input video signal.
AUTOIt automatically switches to the color system of the input signal.

Available selection when the Y, Cb/Pb, Cr/Pr input

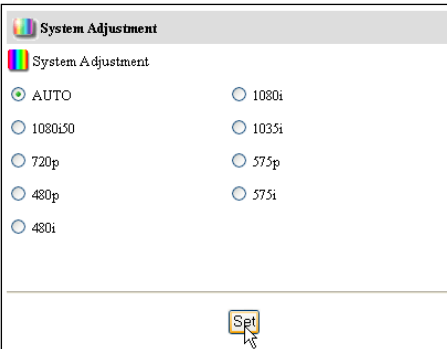

Item	Description
SystemSelects a scanning system of the input component signal.
AUTOIt automatically switches to the scanning system of the input signal.

☞ These selections will not appear when the source mode is selected to the computer mode.



Image Adjustment

This function is to adjust the projected picture image and set the image mode. For selection of image mode, select a desired image mode with the **Image** pull-down menu button and then click **Set** button. The setting items are switched automatically according to selected input mode, computer or video input. To change the setting of each page, click **Set** button on each page. When clicking **Reset** button, all of the contents of the pages are reset.

* Some control items can not be used depending on the selecting input mode or functions of the projector you use. In this case, the values of those items are indicated with "—".

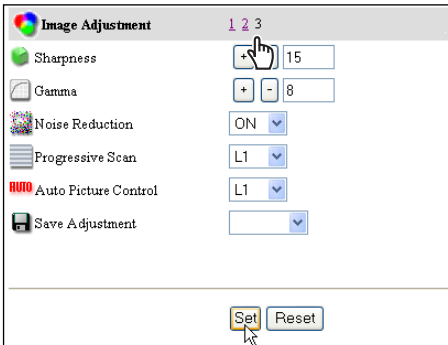
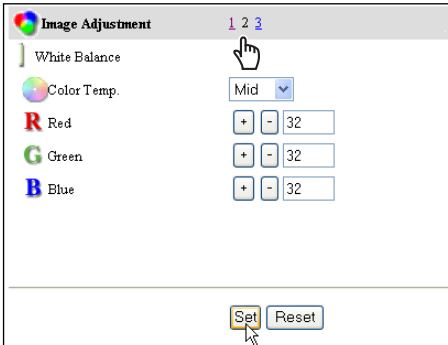
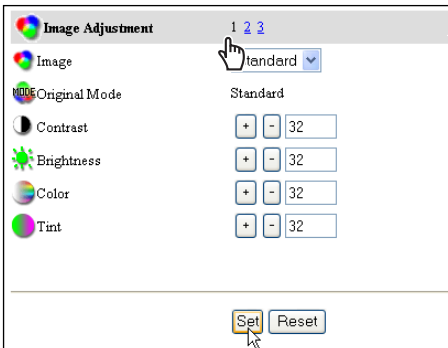

Item	Description
Image	Selects image mode among the Standard, Real*, Cinema**, Image1 to Image4 with pull-down button menu. Image1 to 4 are user preset mode.
Original Mode	Displays which predefined image adjustment mode is based upon.

Adjustment

items Contrast, Brightness, Color, Tint

* This item is only available in the computer input mode.

** This item is only available in the video input mode.

Item	Description
White Balance	
Color Temp.	Sets a color temperature mode.
Red, green, Blue	Adjusts a white balance respectively.

Item	Description
Sharpness.....	Adjusts picture sharpness.
Gamma.....	Adjusts brightness of darker part of the picture.
Noise Reduction	Switches noise reduction on/off.
Progressive Scan.....	Switches progressive mode.
Auto Picture Control	Adjusts picture quality automatically.
Save Adjustment	Select a mode to store the image adjustment values.

Save an image adjustment value

- 1 Decide your desired image adjustment value through the image adjustment pages "1" to "3".
- 2 Display the page "3" and select the desired image number with the pull-down menu of the **Save Adjustment**.
- 3 Register by clicking **Set** button.
To restore the adjustments, click **Reset** button.

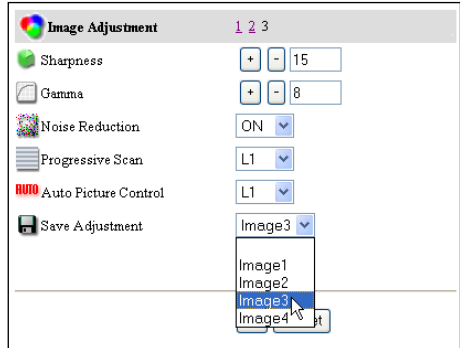

The **Image1** to **Image4** are for the user preset modes to store the image adjustment. The **Original Mode** represents the mode that user preset mode **Image1** to **Image4** is created from the predefined image modes **Standard**, **Real** or **Cinema**.

Load an image mode

Display the page "1" and select a set to load with the pull-down menu button of the **Image** and click **Set** button.

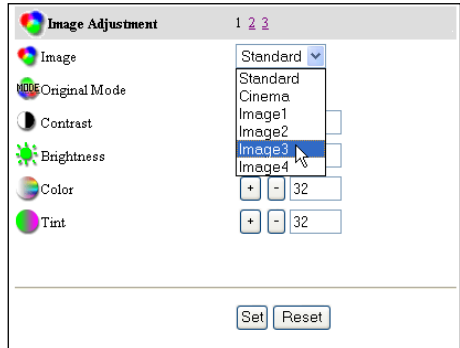



Screen

This function is to adjust the screen mode of the projector. The setting items are switched automatically according to selected input mode, computer or video input.

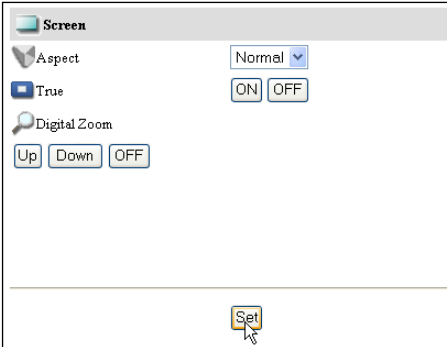

Item	Description
Aspect.....	Changes the screen mode.
True*	Switches the projected image mode.
Digital Zoom*	Adjusts the image zooming or compressing.

* These items are only available in the computer input mode.



Sound

This function is to adjust the sound of the projector. The values in the text box represent the current control value or status.

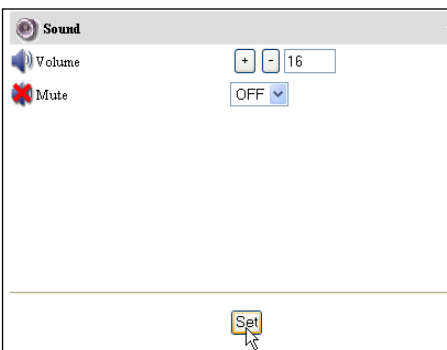

Item	Description
Volume	Adjusts the sound volume from the built-in speakers.
Mute	Suppresses the sound.



Setting

This function is to set up the projector. Click on the page number “1” to “6” linked texts to change the setting pages.

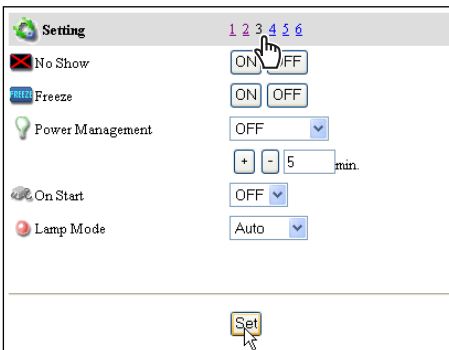
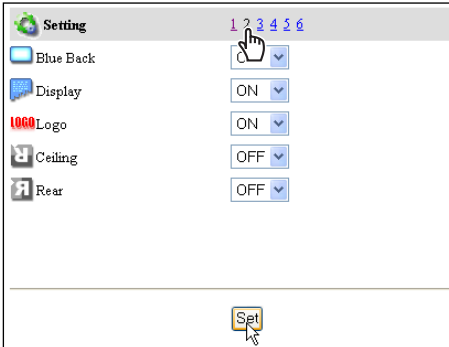
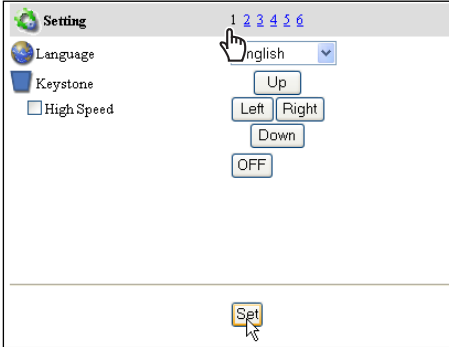

* The displayed items may differ from the actual depending on the functions of the projector you use.

Item	Description
Language	Changes the on-screen menu language of the projector.
Keystone	Corrects the keystone distortion of the projected image on the screen. It moves quickly if “High Speed” is checked.
OFF	Cancels the keystone correction.

Item	Description
Blue Back	Switches on or off the blue images on the screen when no input signal received.
Display	Switches on or off the on-screen menu display on the screen.
Logo	Sets on or off the logo display on the screen during the startup.
Ceiling	Sets the image top/bottom and left/right reversed.
Rear	Sets the image left/right reversed.

Item	Description
No Show	Sets the image black out mode.
Freeze	Sets the image frozen mode.
Power Management	Sets into the selected power management mode, OFF, Ready or Shut Down, if the input signal is interrupted and no control key is pressed for the specified period of time. *
On Start	The projector automatically turns on just connecting the AC cord to the wall outlet.

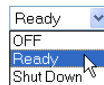

*The specified time can be set up to 30 min.

Lamp Mode.....Switches lamp mode “Auto”, “Eco” or “Normal”.

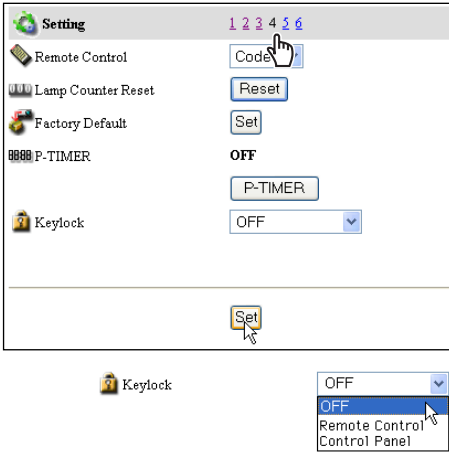

Item	Description
Remote ControlSets one of 8 types remote control codes.
Lamp Counter	
ResetResets the lamp use-time. Reset when replaced lamp.
Factory DefaultSets all of the control items to the factory shipping set.
P-TIMERUsed to display the timer on the screen. The status is changed as ON -> STOP -> OFF when this button is clicked repeatedly.
KeylockSets the prohibition of the projector control by the remote control or the keys on the projector.



(JavaScript On)

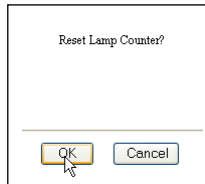

(JavaScript Off)

The confirmation window

The confirmation window will appear when the button of "Lamp Counter Reset" or "Factory Default" is clicked. Click OK button to execute the setting.

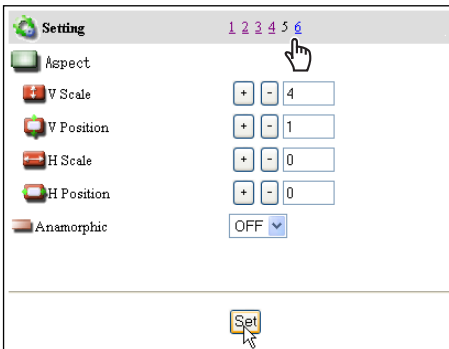

Item	Description
AspectAdjusts each control vertical scale, vertical position, horizontal scale and horizontal position independently.
AnamorphicWhen set to "On", the screen format is set to 4:3 format forcibly.

There are various kinds of ways to change the JavaScript preference depending on the web browser's version and application. Please refer to item "Appendix: Web browser setting/Active Script (JavaScript enable)" (p.96).

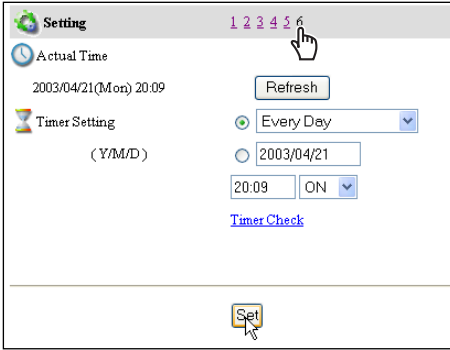

Item	Description
Actual Time	Displays the current time set to the projector.
Timer Setting	Function to switch on or off the projector at the programmed date and time. Please see item "How to set the Timer" for further instructions.

How to set the Timer

This function is used to turn the projector off or on at a programmed day/date and time. Follow the below steps for setting.

1 Set a day or date

To set the timer event at same time everyday, select "day" entry with radio button and then select desired day with the pull-down menu button.

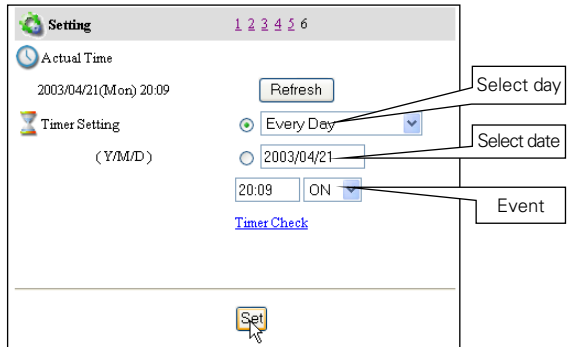

The selectable days are as follows:

- Same time everyday
- Every week (a day from Monday to Sunday)
- Every week (Monday to Friday)
- Every week (Monday to Saturday)

To set the timer event on specified date, select "date" entry with radio button and then type the date with (Year/Month/Date) format.

Ex.: Type [2003/08/20] if you specify [August 20, 2003].

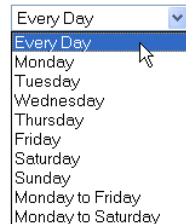

2 Set a time

Type the time with (Hour:Minute) and 24 hours format.

Ex.: Type [18:25] if you specify [PM 6 o'clock and 25 minutes].

3 Select an event "ON" or "OFF".

Select an event **ON** or **OFF** with the pull-down menu button to turn on or off the projector.

4 Register an event

Click **Set** button to register the set timer event. Repeat steps 1 to 4 for another timer event setting.

Check the Timer events

To check the set timer events, click on the **Timer Check** linked text.

20:10 ON ▾

[Timer Check](#)

Timer Check		
<input type="checkbox"/>	ON Every Day	10:30
<input type="checkbox"/>	OFF Every Day	12:30
<input type="checkbox"/>	ON Monday-Friday	17:00
<input type="checkbox"/>	OFF Monday-Friday	19:00
<input type="checkbox"/>	ON 2003/4/9	09:30
<input type="checkbox"/>	ON 2003/4/25	20:15

>>Return Delete

Getting the current time

The displayed time is the value set when the setting page was displayed. This time value is not updated automatically. To update the display time click **Refresh** button.

Setting		1 2 3 4 5 6
Actual Time	2003/04/21(Mon) 20:09	<input type="button" value="Refresh"/>
Timer Setting	<input checked="" type="radio"/> Every Day ▾ <input type="radio"/> (Y/M/D) <input type="text" value="2003/04/21"/>	
	20:09 ON ▾	
	Timer Check	
	<input type="button" value="Set"/>	

Notes on timer setting

Up to 10 timer events can be registered. Timer events always operate according to the next valid event depending on the projector's power status. In the example below, event 3 turns on the projector so next event 4 (also turning on projector) will not be effective because the projector is already turned on. Similarly, when the projector is turned off by event 5, event 6 OFF will not be effective in turning it off again. But these secondary events (event 4 and event 6) will become effective if a person turns off the projector (after event 3 and before event 4) or turns on the projector (after event 5 and before event 6).

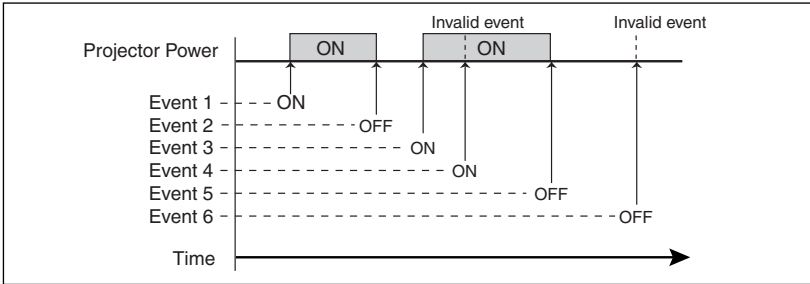

- When the timer events are set at the same time, the last event set will override the previous events. For example, if there is an event like "On at 8:00 everyday" and then new event is set like "Off at 8:00 everyday", only the last setting event is effective.
- When the timer event ON occurs during cooling down period, this is invalid event because the projector cannot be turned on during this cooling down period.

Cancel the timer

To cancel the timer event, check the timer event you want to delete and then click **Delete** button.

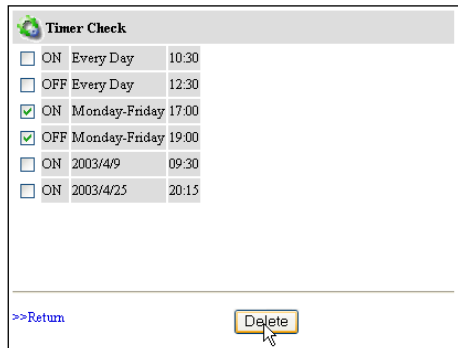

The timer operates by using the clock function provided in this product. Before setting the timer, please confirm that the current date and time are set correctly. Timer and clock functions are functioning using a lithium battery provided in this product. When the battery runs down, the clock and timer functions will not operate correctly. Consult your local dealer for the replacement of battery. The replacement must be carried out by a qualified service personnel.



Service

This function sets the cooling fan speed of the projector. Set proper fan speed depending on the installation environment. Select "Normal" or "Maximum" with the pull-down menu button and click **Set** button.

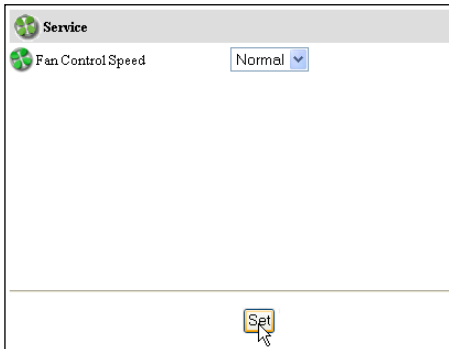



Save Actual Adjustment

This function is to save and load the control values of the projector. The storable control items are Input, PC, System, Image and Screen controls, and these control items differ from each selected input mode and functions of the projector you use.

1 Adjust and set the controls

Set the controls properly according to the selected source. (see pages 41-47 for further adjustment)

2 Select the Save page

Click on the **Save** icon from the control menu. The setting page is displayed as the right. Change pages by clicking on the page numbers "1" to "8" linked text and check the current settings. For further information please see the next page.

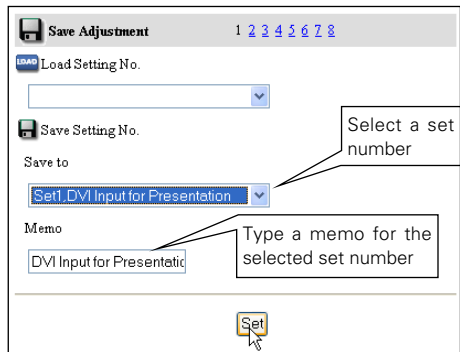

3 Name the current setting

Select a set number (Set1 to set10) you intend to store current settings with the pull-down menu button of the **Save Setting No.:** **Save to**. Name this set number onto the **Memo** text area.

4 Save the current setting

Click **Set** button to store the current setting and name into the selected set number.

You can store up to 10 sets of controls into the network unit.

Check the Save items

Browse pages by clicking on the page numbers and check each setting status. The pages for the saving items are constructed by 8 pages. The contents of the pages may differ from the actual depending on the selected input mode and the function of the projector.

Save Adjustment		1 2 3 4 5 6 7 8
Actual Adjustment		
Input		
Input 1	RGB(Analog)	
PC Adjustment		
Current Mode	---	
Fine Sync	0	
Total Dots	0	

Save Adjustment		1 2 3 4 5 6 7 8
Horizontal	0	
Vertical	0	
Clamp	0	
Display Area H	0	
Display Area V	0	
Full Screen	---	

Save Adjustment		1 2 3 4 5 6 7 8
System Adjustment		
Color System Setting	AUTO	

Save Adjustment		1 2 3 4 5 6 7 8
Screen		
Aspect	Normal	
V Scale	4	
V Position	1	
H Scale	0	
H Position	0	
Anamorphic	OFF	

Save Adjustment		1 2 3 4 5 6 7 8
Image Adjustment		
Original Mode	Standard	
Contrast	32	
Brightness	32	
Color	32	
Tint	32	

Save Adjustment		1 2 3 4 5 6 7 8
White Balance		
Color Temp.	Mid	
Red	32	
Green	32	
Blue	32	

Save Adjustment		1 2 3 4 5 6 7 8
Sharpness	15	
Gamma	8	
Noise Reduction	ON	
Progressive Scan	L1	
Auto Picture Control	L1	
Lamp Mode	Auto	

Load a control set

Select your desired set number with the pull-down menu button of the **Load Setting No.** and then click **Set** button. The setting values of the selected set number are applied to the current settings.

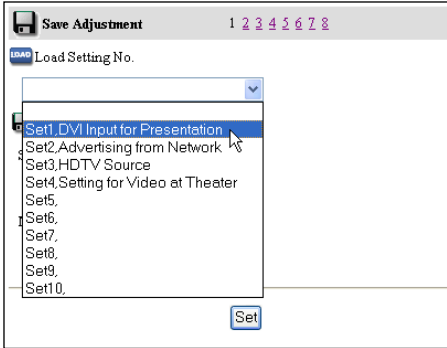

Example of setting



Control the projector's menu

Click **Menu** on the main menu. The following menu control page is displayed. This page is to control the on-screen display menu of the projector.

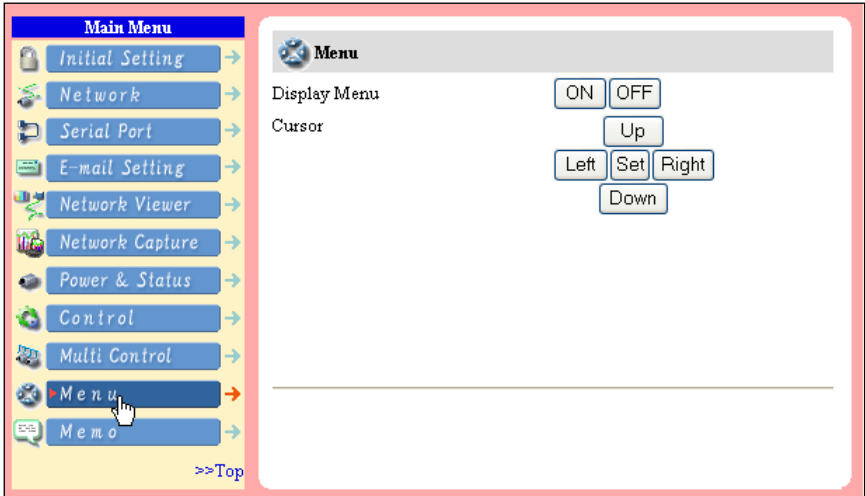

Item	Description
Display MenuTo switch the on-screen display menu on or off by clicking ON or OFF button. The same operation with the MENU button on the projector and remote control handset.
CursorUsed to select an item or adjust value in on-screen menu by clicking Up , Down , Left and Right button. The same operation with the point buttons on the projector and remote control handset. Used to execute the item selected by clicking Set button. The same operation with SELECT button on the projector and remote control handset.



Make a memo

Select the Memo setting page by clicking **Memo** on the main menu. The following setting page is displayed. It is convenient to use as a memo for the simple description where the projector is placed in. This note will be displayed on the login page.

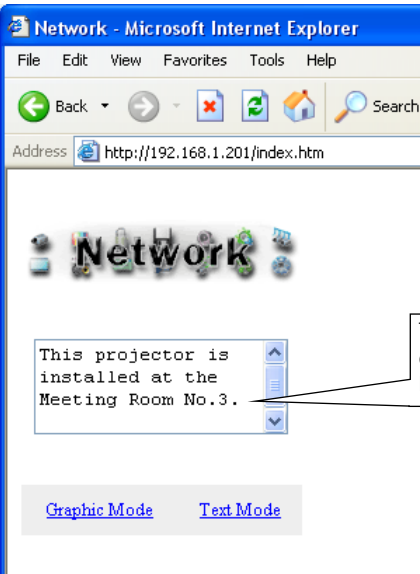
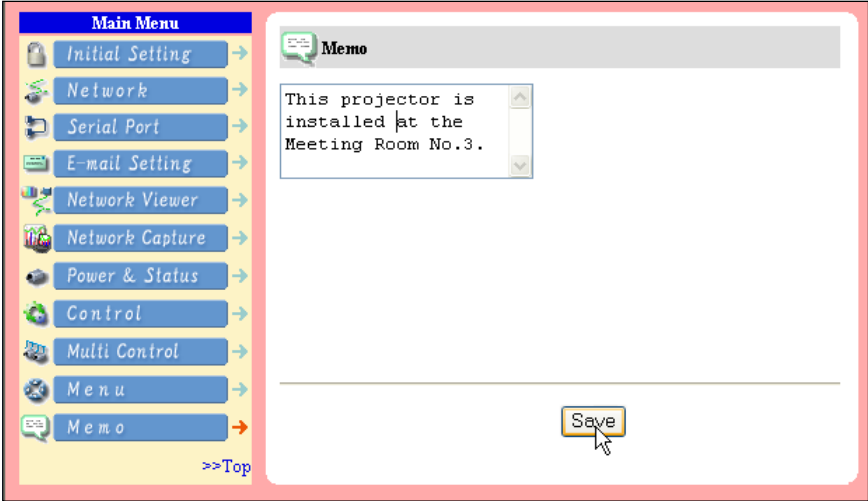

The saved memo is displayed on the login page.

The data of the memo is stored into the network unit.

Chapter 5

Network Viewer & Capture

5

ENGLISH

Using the Network Capture function

The Network Capture is a function to project the screen images of the computer by the projector via the network by using the Network Viewer software. Up to 10 computers can be registered and the capture images of the computer projected by the projector can be selected by the Network Capture software in the computer, web browser and projector. *The network capture function cannot be used when using the network viewer function.

Launching the Network Viewer

After installing the Network Capture software, the shortcut icon is copied into the "Startup" folder. When you boot the computer, the Network Capture software also starts and its icon stays on the task bar. If the icon is not appeared on the task bar, the Network Capture software does not start. Click "Network Capture" from "Start" - "All the Programs" - "Network Viewer & Capture" menu to launch it manually. The status which the Network Capture icon stays on the task bar is just preparing the screen capturing.

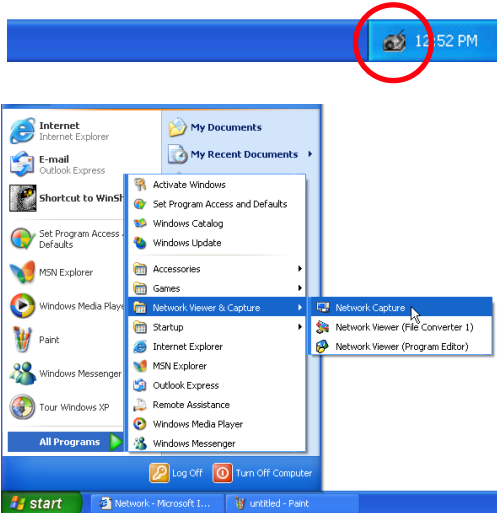

Parameter Determination

- 1 Click Network Capture icon on the task bar.
- 2 Click "Parameter Determination" on the popup menu. The setting window will appear.
- 3 Set Capture Port and Mouse Port to match to the projector's port number.

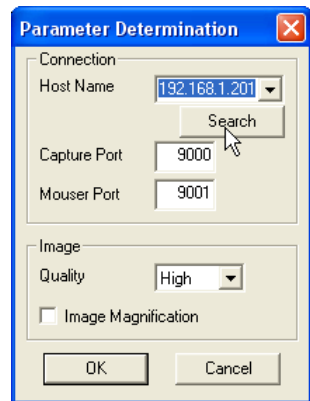
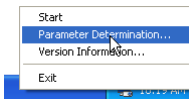

- * To check the projector's setting, access to the control page with the web browser. For further instruction, please see item "Control by the web browser" (p.62)
- * Specify the port number of TCP/IP. The default port setting is 9000 and 9001 respectively. There are some reserved port numbers and also some applications may use their own port numbers. If one of those port numbers is used, the alert dialog window will appear and let you know that it is an invalid port number. In this case, use another port number.
- * The reserved port numbers are http (80), ftp (21), telnet (23), etc. The port no. 10000 is reserved to control the projector through the LAN port.

- 4 Click **Search** button to list up the available IP address assign to the projector and select desired IP address you use, or you can enter the IP address manually if you know that IP address.
- 5 Set the quality of the image.
 Quality: Selects from High, Mid, Low
 Image Magnification: If checked, the screen image size of the computer is automatically adjusted to the projector's screen size.
- 6 Click **OK** button to close the setting window.

About Image Quality

- Quality : Quality mode of the captured image shows following JPEG compression mode.;
- High : JPEG low compression mode
 - Mid : JPEG medium compression mode
 - Low : JPEG high compression mode

[1] Control by the computer

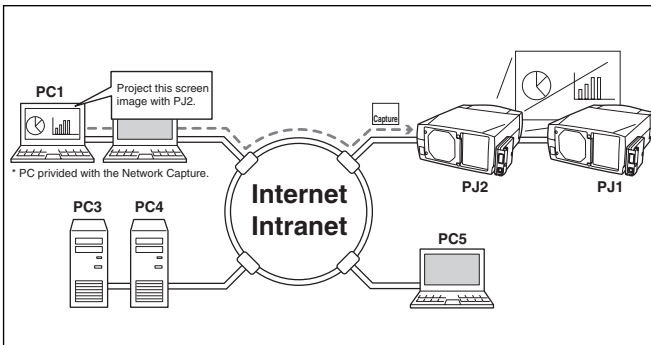

* Start capturing from the computer.

Select input mode to the "Network" previously.

- 1 Click **Network Capture icon** on the task bar.
- 2 Click "Start" on the popup menu.
 The captured screen image of the computer will appear on the projected screen.
 * If the error message appears, check "Parameter Determination" described on the previous page.
- 3 To stop capturing, click "Stop" on the popup menu.

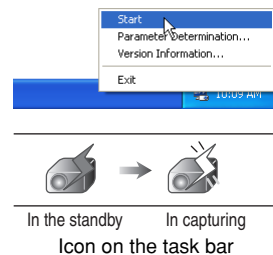

[2] Control by the web browser

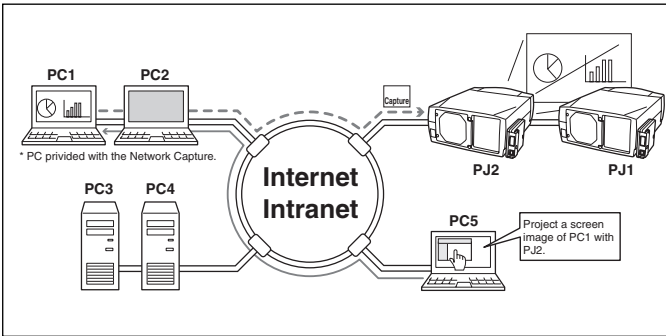

* Start capturing of the PC1 from the PC5.

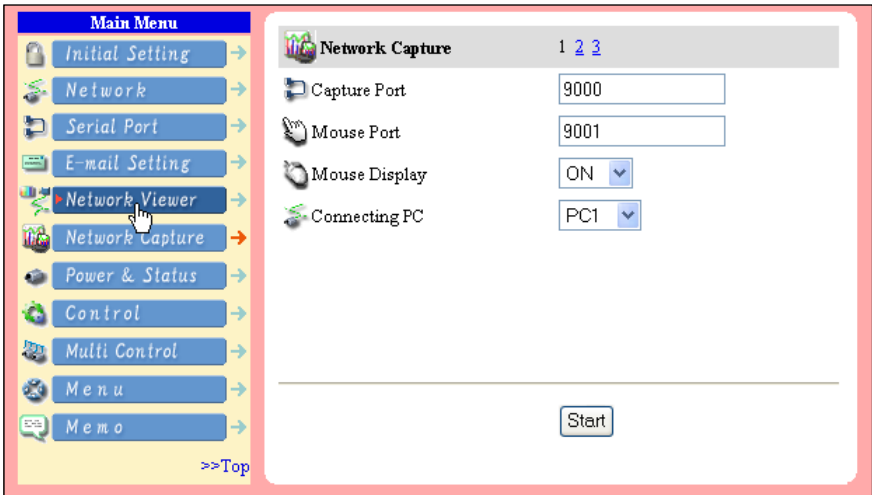

Select input mode to the "Network" previously.

1 Access to the control page on the projector by using the web browser. From the main menu, click **Network Capture** to display the setting page (☞ p.26).

2 Select the computer number to connect from the pull-down menu button of "Connecting PC" and click **Start** button.

* The IP address of the connecting PC should be registered previously (☞ p.63).

* Set the Capture Port and Mouse Port to match to the computer's port number you intend to connect (☞ p.61).

* Set "On" on the "Mouse Display" when you want to display the mouse cursor on the screen.

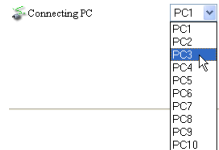

3 Click **Stop** button to stop capturing.

* You can use the capture function by using the web browser or the projector if the Network Capture software is installed into the computer correctly and its icon stays on the task bar.

Registering the computers

Up to 10 computers can be registered. To register a computer, on the Network Capture setting page, click the page number "2" or "3" linked text to change to "Connection Setting" page and enter the IP address of the computer to the PC number, and then click **Set** button.

* The registered computer starts capturing if only the Network Capture icon appears on the task bar.

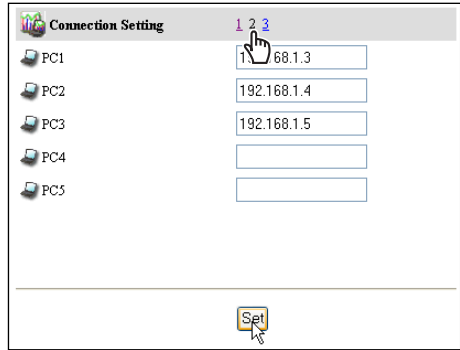

[3] Control by the projector

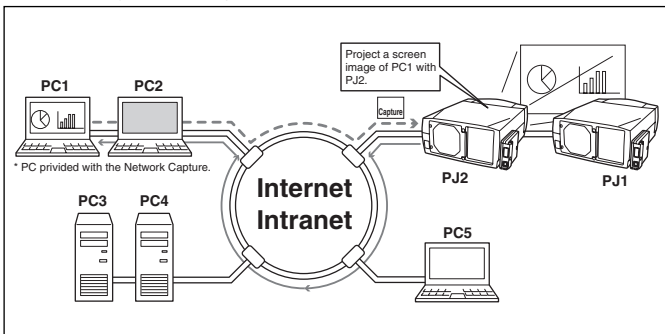

* Start capturing of the PC1 from the projector PJ2.

Select input mode to the "Network" previously.

- 1 Display the menu bar on the projected screen by pressing the **MENU** button on the projector or the remote control handset.
- 2 Select "Network setting" icon by using the point buttons (◀▶) and press **SELECT** button once. Check the mode is "On".
- 3 Select "Network Capture" icon by using the point buttons (▲▼) and then press **SELECT** button. The setting window will appear.

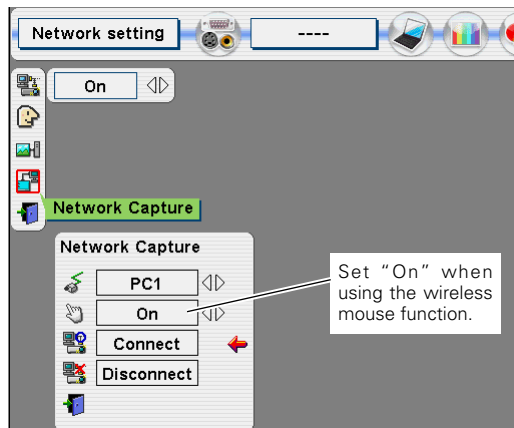

- 4 Select the PC number to connect by using the point buttons (◀▶).
- 5 Select "Connect" and then press **SELECT** button to start capturing. To stop capturing, select "Disconnect" in the above window and the press **SELECT** button.

* The projector does not provide the function to register the IP address of the computer and to set the parameter of the capturing. They should be registered by using the web browser previously (see p.62-63).

Advanced using example

Displays the presentation data stored in the computer by using the wireless mouse function from the projector.

1 Start capturing of the computer PC1 by using the projector.

Select "Network Capture" icon from the menu and select "PC1" and then select "Connect" (☞ p.63).

=> The Network Capture software installed in the selected computer will start capturing.

2 On the PC1 capture image projected on the screen, search a presentation file data stored in the PC1 by using the wireless mouse function of the remote control supplied with the projector.

3 Select a desired file and double click with the remote control .

=> The application by which the document was created starts and the projector projects the presentation picture on the screen.

4 Start the presentation.

=> By using wireless mouse function, control the page browsing and some another operations for the PC1.

* For further instructions of the wireless mouse, please refer to the projector's owners manual.

* On the projected screen using with the network viewer, the shape of the mouse pointer differs from the one on the computer's screen.

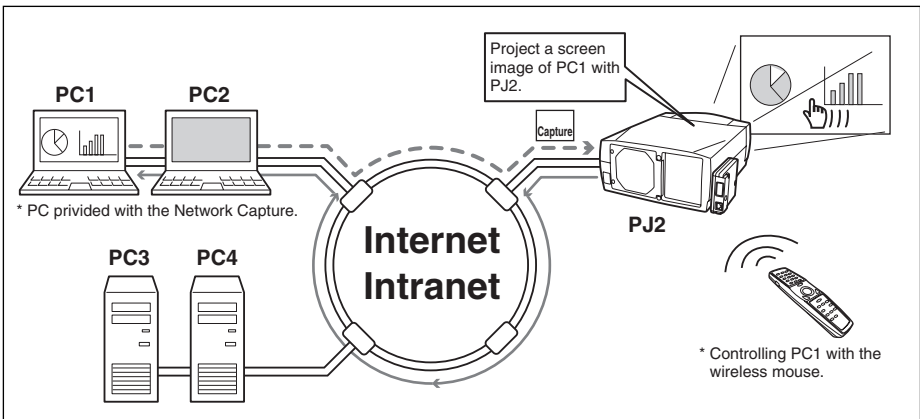

Setting condition

Projector

Input mode: Network

Network Unit

Registering the connection: The IP address of the computer and proper parameter must be set to the PC1 (☞ p.61, p.63).

Mouse Display: "On" (☞ p.62)

Computer PC1

Software: The Network Capture software is installed correctly and its icon appears on the task bar.

Create the available data [File Converter]

The image available with this projector is the JPEG format. There are several types of JPEG data. Before using the images with the Network Viewer function, it should be converted to the optimized JPEG data for this projector.

[1] How to use the Network Viewer (File Converter 1)

The File Converter 1 is a software to convert from the JPEG data or bitmap data to the optimized JPEG data for the projector.

Launch and quit the File Converter 1

To launch the File Converter 1, click "Network Viewer (File Converter 1)" menu from "Start" - "All Programs" - "Network Viewer & Capture" menu.

To quit the File Converter 1, click on the close box on the upper right hand of the window.

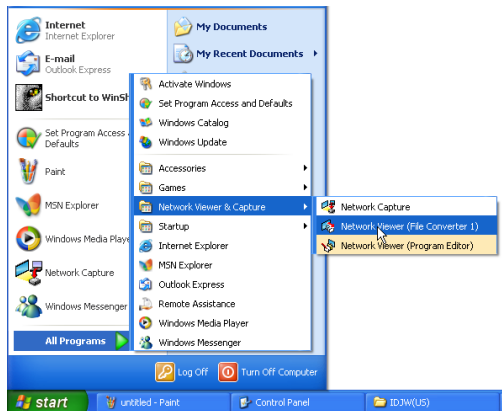

File Converter 1 window

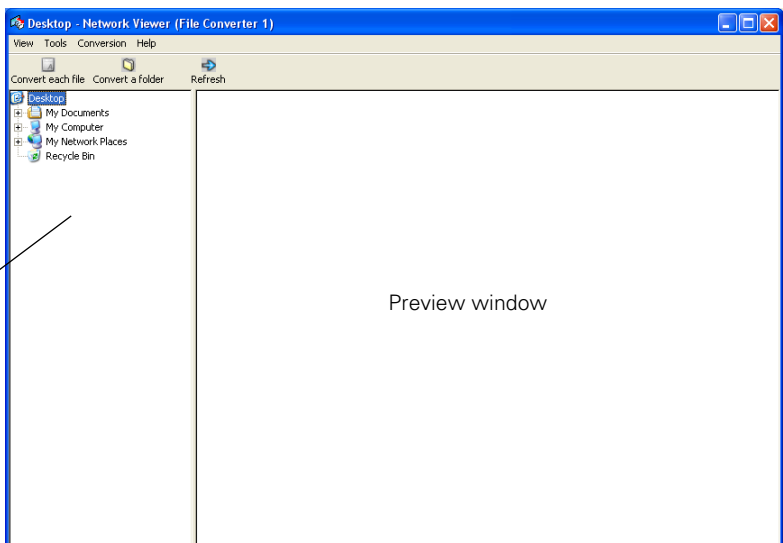

Explorer window to browse image files

Preview window

Converting procedure

1 Select a folder in which the image files are stored by the explorer window.

The preview images of the available image data (JPEG file, BMP file) in the selected folder are displayed on the preview window.

* On the preview window, the preview displayed with the red frame represents a file not optimized for the projection. The preview without the red frame represents the optimized JPEG file for the projection. So you do not need to convert them again, but if you change the size or image quality, perform to convert them again.

2 Click "Convert a folder" when converting all the files in a selected folder.

When converting each file, select a preview image first and then click "Convert each file".

* To select two or more files at once, press and hold "Shift" key or "Ctrl" key and then click the preview images.

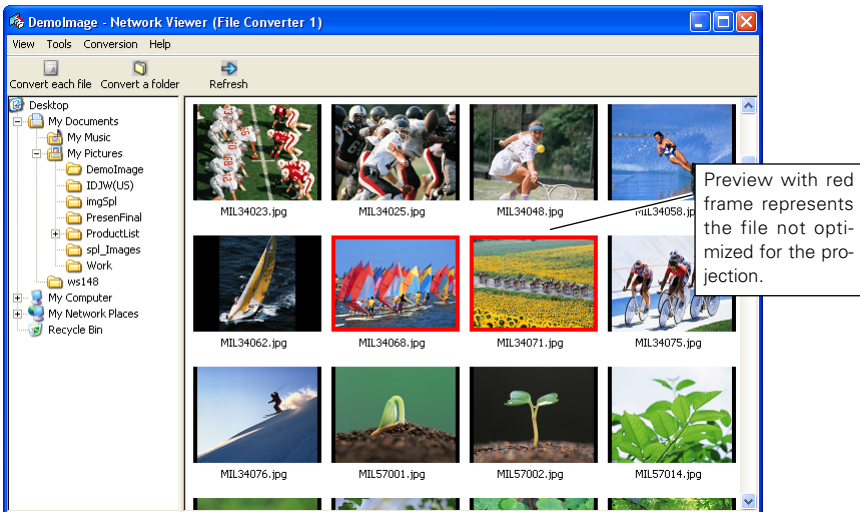

3 As the confirmation window appears, check the conversion object and conversion type and then click OK button. The File converter 1 starts converting and stores the optimized files into the output folder.

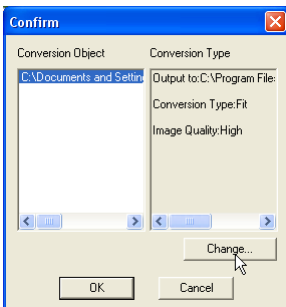

* To change the conversion type or output folder, click **Change** button on the confirmation window. Please see the next page for the setting of conversion mode.

Setting of conversion mode

When clicking **Change** button on the confirmation window in the step 3 on the previous page, following option setting window appears.

Conversion type:

- FitConverts as either width or height of the image sets to be the maximum screen width or height.
- Justify[both ends]....Converts as width of the image sets to be the maximum screen width.
- Justify[top and bottom]Convert as height of the image sets to be the maximum screen height.
- CutCuts image with the screen size not depending on the image size. This type has following mode.

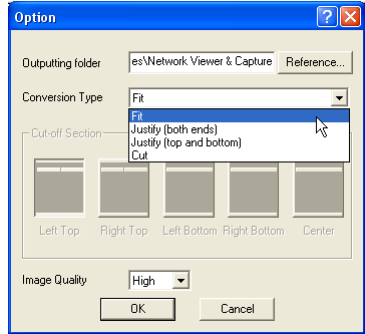

* Select this mode when you want to have the images with the original size. Select each mode by clicking on the button.

Image QualitySelect an image conversion quality with "High", "Mid" or "Low".

Other menu items

- View: Preview size: Sets preview mode with the Large, Medium, Small
- Tool: Option: Sets default mode in the conversion

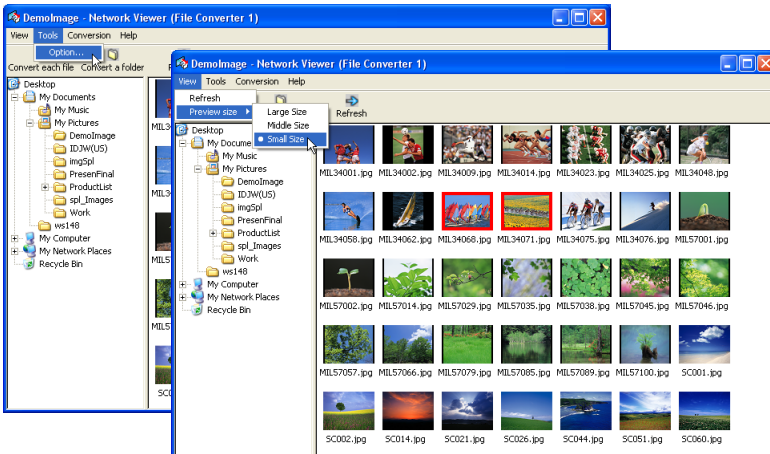

ENGLISH

[2] How to use the Network Viewer (File Converter 2)

The File Converter 2 is a kind of the printer driver software to convert to the optimized JPEG data for the projection from the any documents created by the other software such as text editor, spreadsheet or presentation software. It is possible to convert to the JPEG file from the any kinds of documents created by the software which has a "print" menu.

Conversion procedure

- 1 Open a document with the individual software.
- 2 Select a "Print" sub menu and open the printing dialog. On the window, select "Network Viewer (File Converter 2)" icon on "Select Printer" item and click **Print** button.

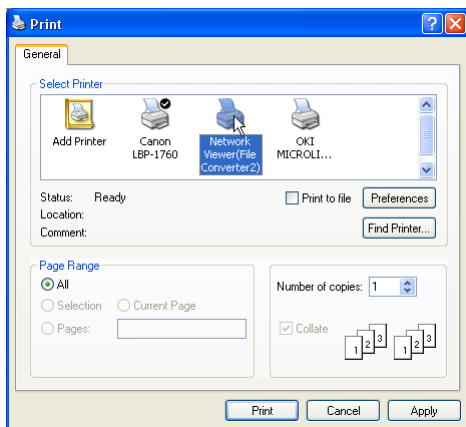

* Set the option setting for the page layout or paper setting by clicking **Preferences** button if required.

- 3 Select a folder and click **Save** button.

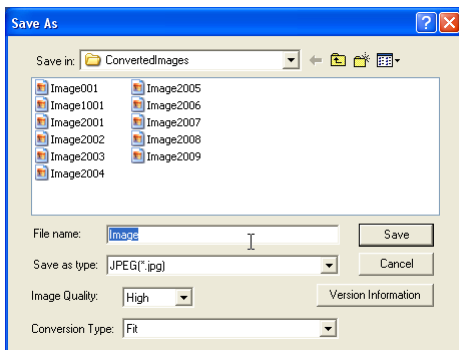

- * The file name is named with "Image001" as the default. If the converted image has 2 or more pages, the file names are numbered from "001" to "999" sequentially.
- * Image quality and Conversion type can be setup this window. For further information, please see "Setting of the Conversion Mode" (p.67).
- * It may appear the white space around the edges on the converted image depending on the type of the image data.

* The above procedure may differ from each computer environment and applications.

Making a program file [Program Editor]

Network Viewer (Program Editor) is a tool to make a program file specify the stored information of the JPEG images in the file server (ftp server) and the order of the display images. Program Editor makes a folder “DispParam” at the login root directory in the file server and makes files as each program name into this folder. These files are called as “Program”. By specifying the program file with the Network Viewer function, you can have the programmed display with the projector .

Procedure of making program

- 1 To launch the Program Editor, click “Network Viewer (Program Editor)” menu from “Start” - “All Programs” - “Network Viewer & Capture” menu.
- 2 Click **Connect** button.

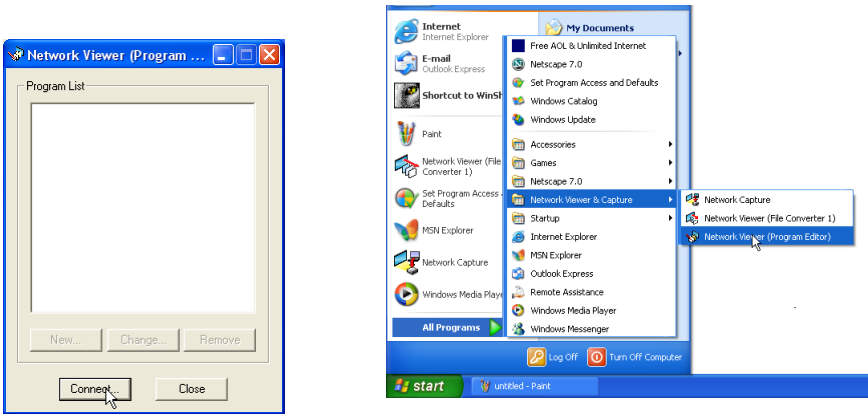

- 3 If the connection setting window appears, enter the each item and then click **OK** button.

Host name.....Enter the ftp server name

Root Folder.....Specify the root directory of the ftp server. Normally use “/”.

User IDEnter your login account of the ftp sever or use blank when you login as anonymous account for the ftp server

PasswordEnter your password or use blank when you login as anonymous account.

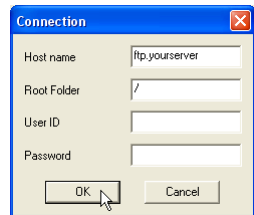

IMPORTANT
 It is required to set the write permission mode for the login directory of the ftp server. If only the read only mode, you will have an error when you register a new program.

ENGLISH

The setting window disappears and then the programs are listed on the window if there are program files at the login directory in the connected ftp server.

4 Click **New** button.

5 Enter a program name and click **Add** button.

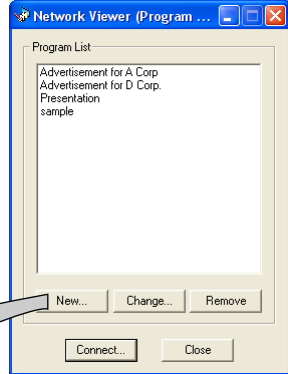
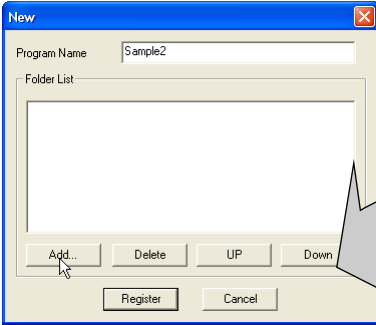

Change : Changes the contents of the program file.

Delete : Deletes the program from the list.

6 The folder selection window appears and select a folder in which the JPEG data are stored and then click **Add** button to register into the folder lists.

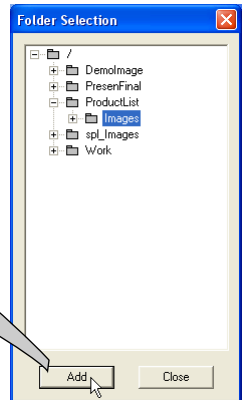
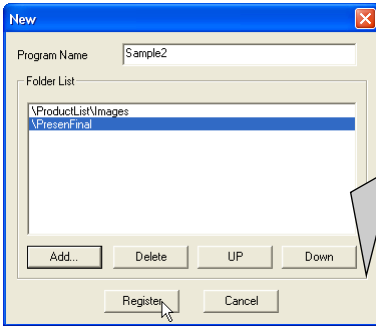

AddDisplays the folder selection window.

DeleteDeletes the folder path from the folder list.

UPMoves up the selected folder path.

DOWNMoves down the selected folder path.

* The order of the display is listed in the folder list window. To change the order of the display, change the list order of the folder list by using **UP** or **DOWN** button.

* The programs are stored into the "DispParam" folder at the login root directory and this "DispParam" folder is made by software automatically.

7 Click **Register** button to register the folder list into the program.

8 Click "Close box" to quit the Program Editor.

Use the web browser to access to the control page of the projector. Click **Network Viewer** on the main menu on the web page, then connect to the file server and select the program name which was made at previous section. The projector starts displaying the images along with the program. For further information, please see "Using the Network Viewer function" (p.72).

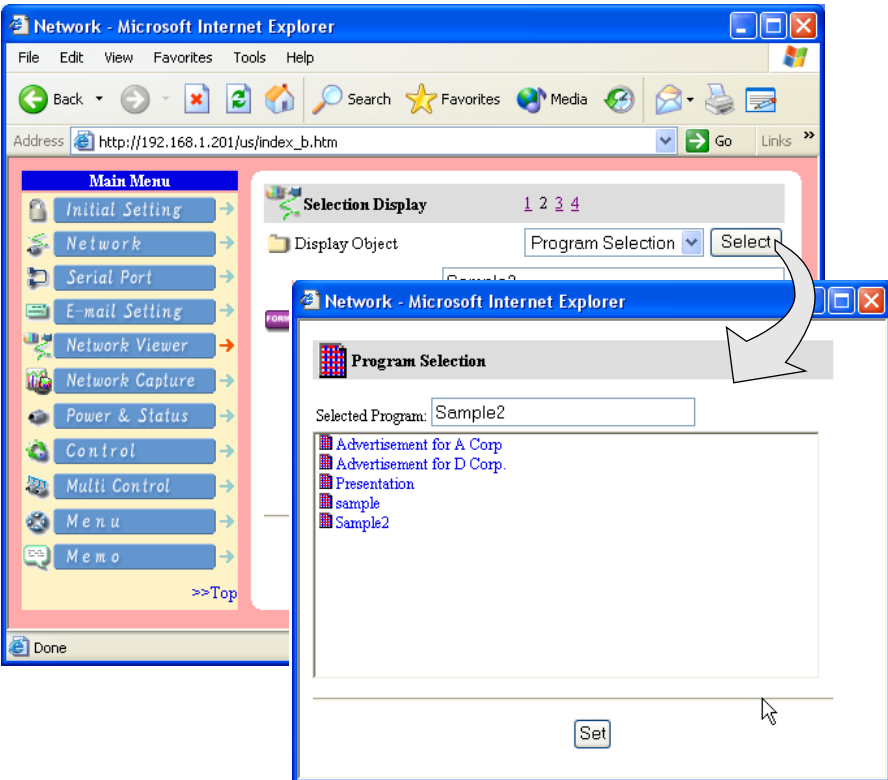

The limitation of the Program file

There are several limitations for the program file as follows;

- * Number of programs in a root folder is less than 1000.
- * Number of folders in a program is less than 100.
- * Total characters of folder name is less than 255.
- * Total characters of program file name is less than 63.
- * Do not make a program name started with ".".
- * Do not make a program name contained with following characters:
 \ / : ; * ? " < > |
- * The program name started with " " (space) is registered with removing the space.

Using the Network Viewer function

The Network Viewer is a function to acquire and project the JPEG image data on the screen from the file servers placed in the network. The projected image data are specified with the folder unit. You can set the display period and repeating times, and also you can register those folders as the program. *The network viewer function cannot be used when using the network capture function.

Condition to use the Network Viewer function:

- * Enables to use the ftp service with Windows 2000 Professional or XP Professional.
- * User must have a full-access account to the ftp server or the ftp server allows anyone to use with "Anonymous" account which also has a full-access mode.
- * The allowed number of the same connection limits from the same IP address is more than 20.

[1] Control by the web browser

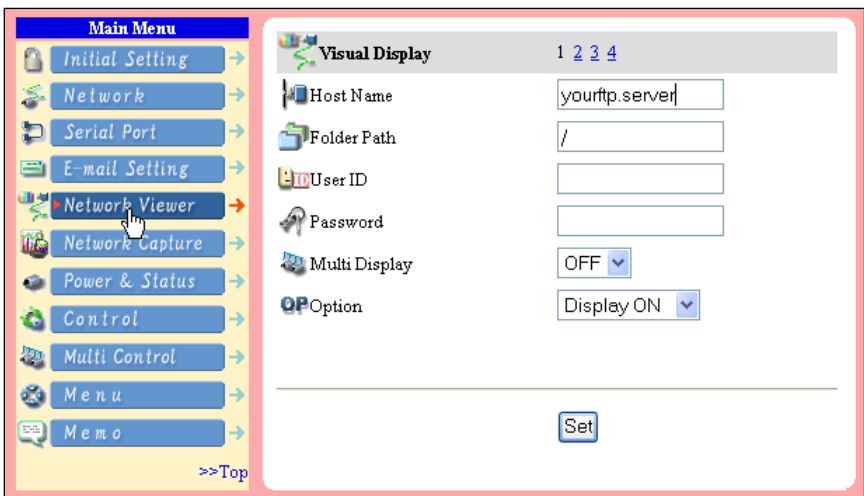
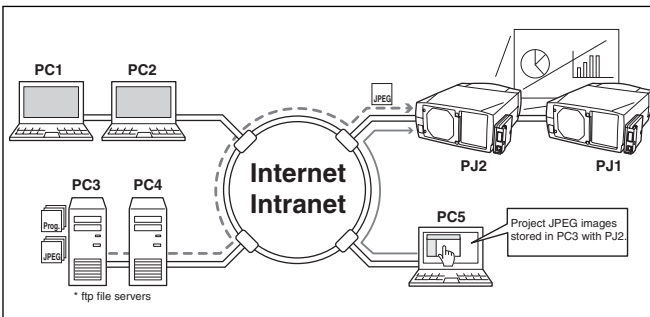

Select input mode to "Network" previously.

1 Access to the control page on the projector by using the web browser. From the main menu, click **Network Viewer** to display the setting page.

2 Setup the setting page [1] of the Visual Display.

Host nameEnter the name of ftp server, yourftp.server etc.

Folder Path ..Use "/"(root directory) in normal, or enter the directory name follow the "/" as shown in the below example if you have a specified directory in the server.
/data/

User IDYou may skip when using the anonymous account

PasswordYou may skip when using the anonymous account

OptionSet "Display On" when you display the acquired preview images on the web browser.

3 Select Multi Display On or OFF to display images for multi projectors. When setting "On", the same images are projected with multi projectors that are registered to the multi control, described on chapter 6 "Controlling the multi projectors" (p.79-82).

4 Setup the setting page [2] of the Selection Display.

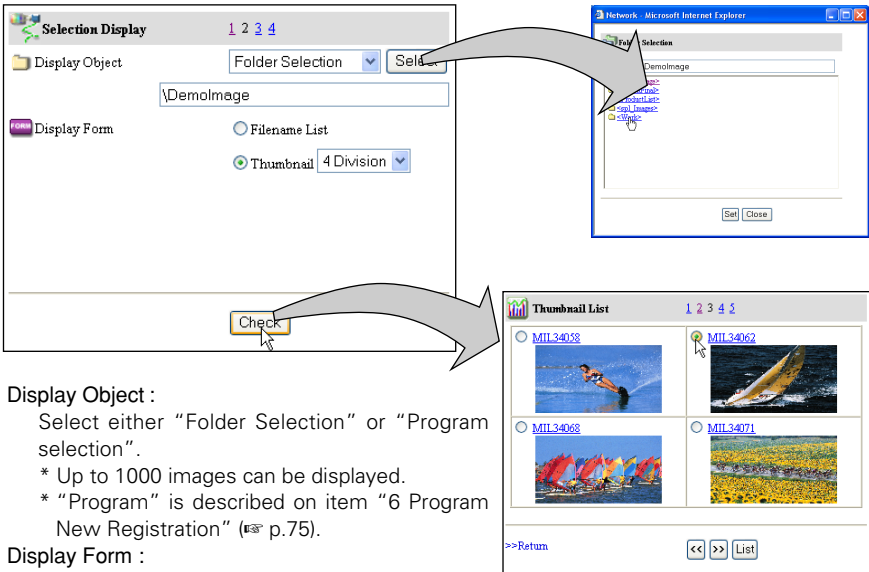

Display Object :

Select either "Folder Selection" or "Program selection".

- * Up to 1000 images can be displayed.
- * "Program" is described on item "6 Program New Registration" (p.75).

Display Form :

Select either "filename list" or "Thumbnail".

When clicking **Check** button, the images or file names in the selected folder or program are listed on the preview page. In this page, when clicking on the radio button next to the file name, the selected image is projected on the projector's screen and set its page as the starting page for "Auto Display" function on the next page.

* The display order of the files is according to the ASCII character order.

***1 IMPORTANT NOTICE**
Please note that if you use the ftp server with personal account except anonymous account and set "Display ON" at the option setting item, the user ID and password are displayed on the browser as the image linked address information. We recommend that this function should be used with the anonymous account usually.

5 Auto Display setting and control page [3]

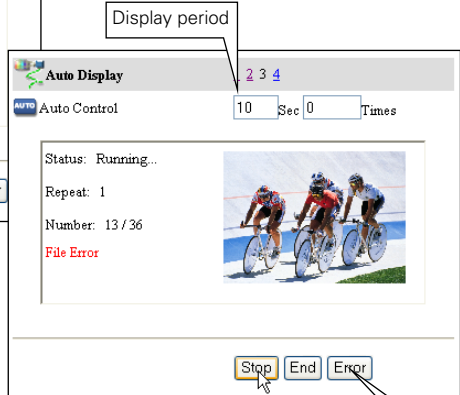
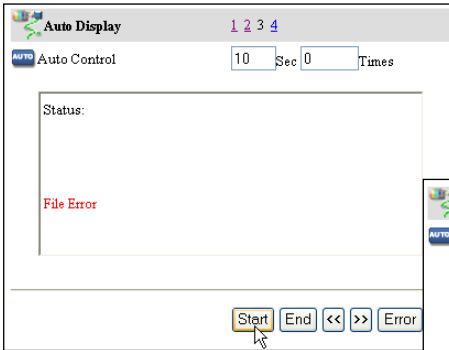

Auto ControlDisplays period (3 to 240 sec.),
Repeating times (1 to 999 times)
* 0 times represents endless display

The display status is indicated on the text area.

- Start.....Starts automatic-image displaying
- EndQuits automatic-image displaying
- Stop.....Stops automatic-image displaying
- <<Displays the previous image
- >>Displays the next image
- ErrorDisplays the details when the file error is occurred

Click here to display the details when the file error is occurred.

* When the file error is occurred during the automatic display, you may have the alert e-mail message. For further information, please see item "4 Condition selection for sending alert message" (☞ p.35).

* Error type

'File Error'It is displayed when the network unit cannot acquire the correct file images from the ftp server, or when the master projector is turned off during the multi-control.
Click **Error** button to check the details.

'Connection Error' ..It may be displayed when the slave projector is using the Network Viewer or capture function during the multi-control. For further error details, please see chapter "Multi Control/Check & Change" (☞ p.82).

Caution

- * The display period is greatly affected by the network environment or the operation of multi control, so it may not display the image as the specified display period.
- * The switching is not the same timing between the images on the screen and on the web browser.

6 Program New Registration [4]

1. Click on "New Registration" linked text.
2. Enter a program name and click **Select** button.

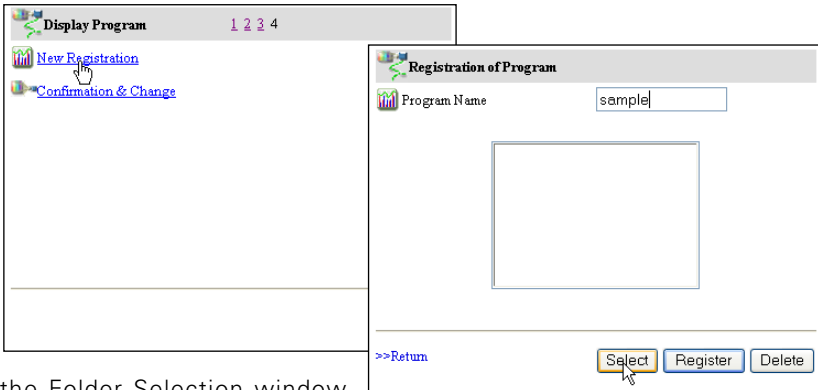

3. On the Folder Selection window, click a folder and click **Add** button. Repeat the above for adding some another folders.
After finishing, click **Close** button.
4. Check that the folder paths you added are listed on the text area. To delete the folder path, select the folder path first and then click **Delete** button.
 - * The folder paths are ordered by creation date, and the images are displayed with this order and it cannot be changed. To change the order, use the Program Editor software (p.75).
 - * Up to 100 folder paths can be added per program.

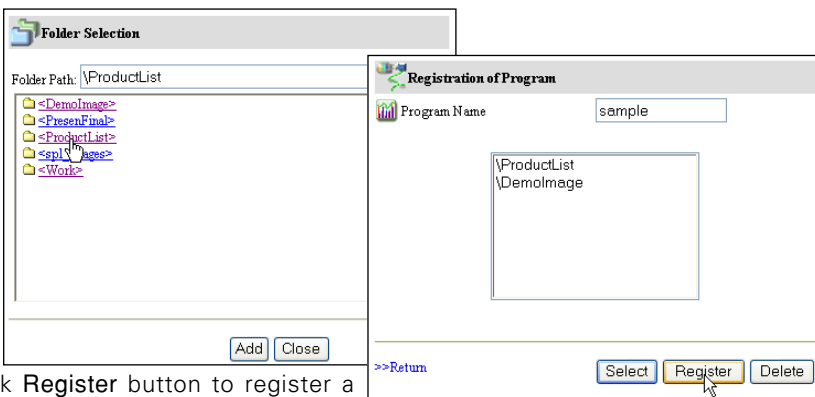

5. Click **Register** button to register a program
 - * Up to 1000 programs can be registered at the same directory.

IMPORTANT

It is required to set the write permission mode for the login directory of the ftp server. Only in the read only mode, you will have an error when you register a new program.

7 Program Confirmation & Change [4]

1. Click on "Confirmation & Change" linked text.

2. From "Program Name" pull-down menu button, select the program name you want to confirm or change.

* Click **Delete** button to delete.

* Click **Select** button to confirm or change the program. The registered folder paths are listed on the text area.

3. To add a new folder which has new images into selected program, click **Add** button and then add new folders in the folder selection window.

* To delete the folder from the program, select the folder path and then click **Delete** button.

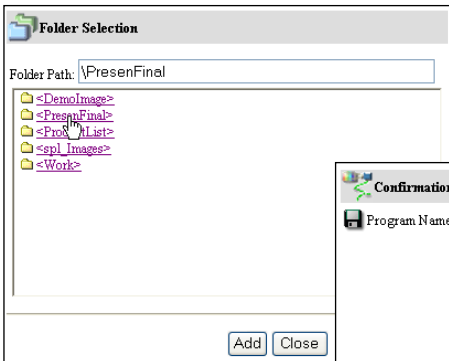
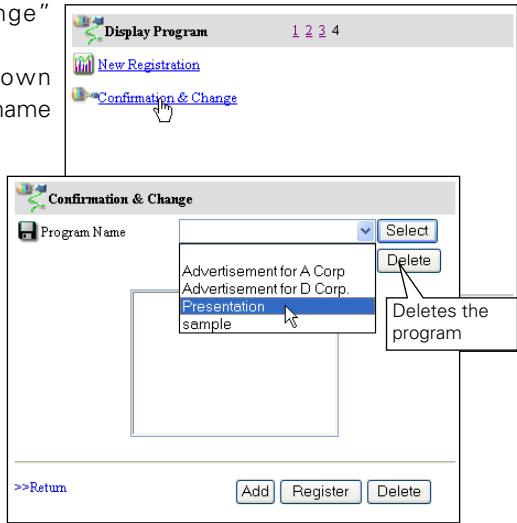

4. After editing the program contents, click **Register** button to update the program.

Click **>>Return** linked text to return to the previous control page.

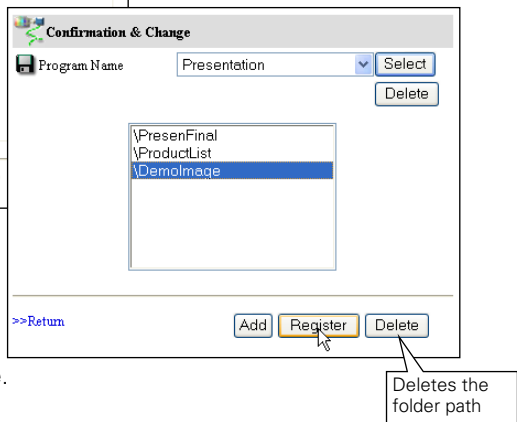

* The folder paths are ordered by creation date, and the files in the folder are ordered by the ASCII characters.

* To change the order of the folder paths, use the Program Editor software (see p.75).

[2] Control by the projector

Select input mode to “Network” previously.

1 Display the menu bar on the projected screen by pressing the **MENU** button on the projector or the remote control handset.

2 Select “Network setting” icon by using the point buttons (◀▶) and press **SELECT** button once. Check the mode is “On”.

3 Select “Network Viewer” icon by using the point buttons (▲▼) and then press **SELECT** button. The setting window will appear.

4 Set as follows to setup the display mode;

Auto-Display: Select “Auto” and press **SELECT** button and the set the display period and repeating times by using the point buttons.

Manual Display: Select “Manual” and press **SELECT** button.

5 Select “Connect” and then press

SELECT button. The projector downloads the images from the file server and projects them on the screen.

* In the automatic displaying mode [Auto], when the left-click button on the remote control is pressed, projector stops automatic displaying and sets into the manual displaying mode. When pressing the right-click button, it starts automatic displaying again.

* During the displaying, you can browse images backward or forward by using point buttons (▲▼) on the remote control or on the projector.

6 To disconnect from the file server, select “Disconnect” and press **SELECT** button.

* The image data used for this function are the program or folder that the Network Viewer function used last time. The projector cannot specify particular images or file servers itself.

* 1 to 255 repeating times can be set. The mark “∞” represents endless display.

* 3 to 240 seconds can be set for the display period. The display period is greatly affected by the network environment or the operation of multi control, so it may not display the image as the specified display period.

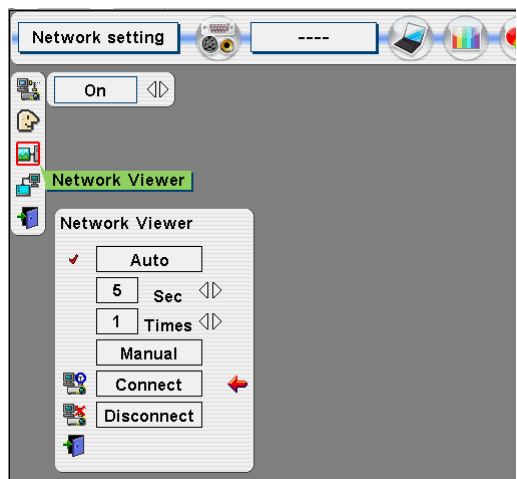
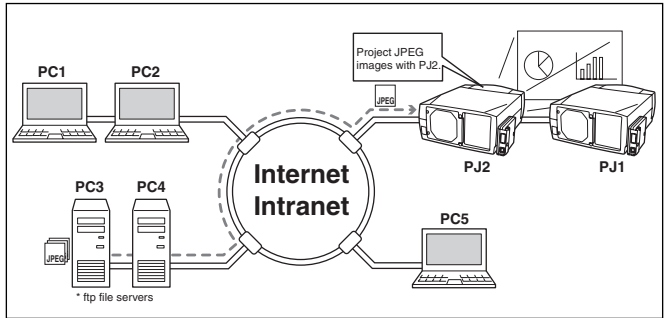

Chapter 6

Controlling the Multi-Projectors

6

ENGLISH

Display the main menu following to the login procedure described on page 26.



Multi-Control

This function enables to control the multiple projectors equipped with the Network Units that are connected to the network at the same time. Click

Multi Control on the main menu to display the control page.

Note:

To control the multiple projectors, each projector must has the same password.

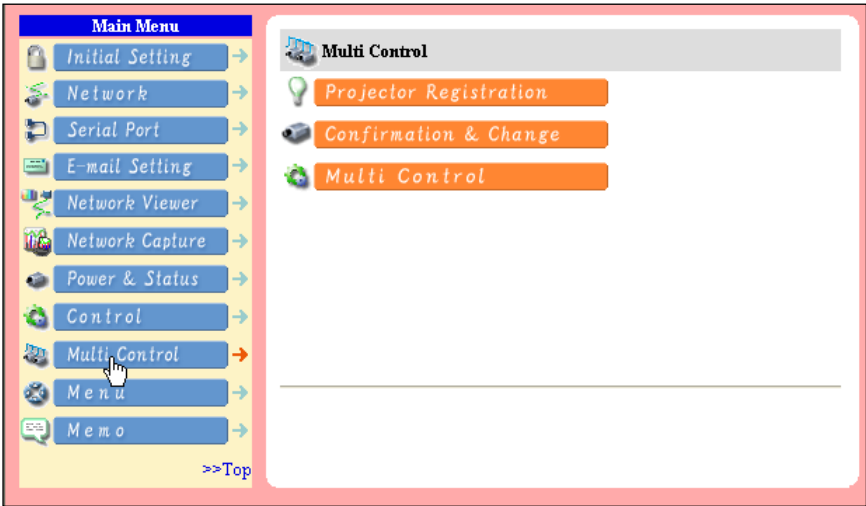

Example of multi control

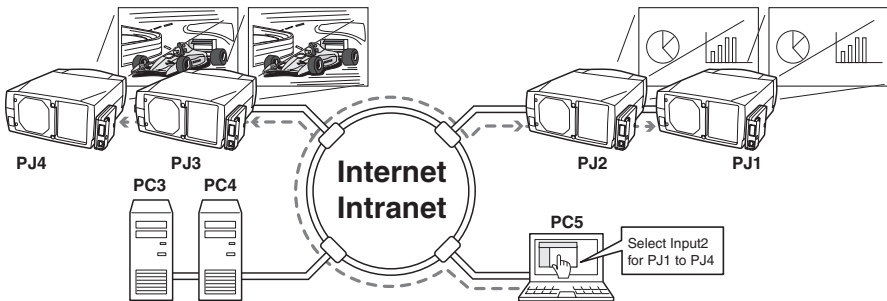

Register IP address and projector name

Click on **Projector Registration** to display the registration page. Type the IP address and projector name*1 if required and the click **Register** button.



Projector Registration

IP Address:

Projector Name:

Multi Control Range:

[Check](#)

[->>Return](#)

Check IP address and projector name

To check the registered information, click on **Confirmation & Change**. The registered information of the projector is listed as the right.

* The word "None" is displayed if the projector name is not registered.



Change

Projector Name	IP address	Control Range	Actions
TheaterNo1	192.168.0.100	Control	
ShowRoomE1	192.168.100.201	Control	
DemoRoom	192.168.200.1	Visual Control	
ShowRoom2F	192.168.1.201	Both Control	
TheaterNo2	192.168.0.200	Visual Control	

Projector name:

When you click on a listed IP address, the login page for the selected projector will be displayed with a new window and then enter the password for this projector and login.

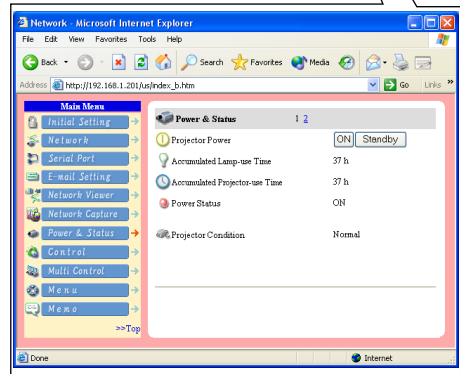

*1 Normally, the projector in the network is recognized with the IP address. This product allows you to name the projector instead of the IP address. By registering the projector's nickname like "MeetingRoom101", it can be managed and recognized easily. If you use the DNS server, register the host name registered to the DNS server as projector name. For further information please consult your network administrator.

☞ You can register the projectors up to 100 sets for the multi-control.

Exclude/Add/Delete a projector

To change the mode of the registered projectors, select a mode with the pull-down menu button under the IP address of the target projector and then click **Set** button.

Mode	Operation
Control	Controlling the projector
Visual Control	Displaying the images
Both Control	Controlling and displaying images
OFF	Excluding from the multi-control
Delete	Deleting from the multi-control

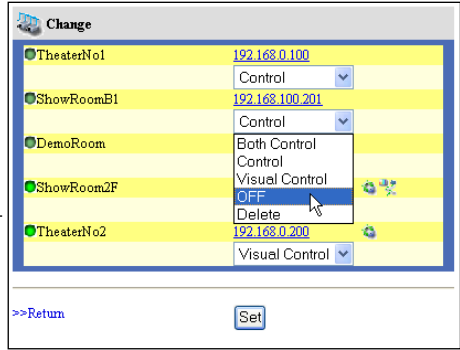

Status

If some of the registered projectors are deactivated by some means (such as disconnecting the power source, disconnecting the LAN cable, disconnecting from the network), control changes will continue to be effective for the projectors that are still activated. At the same time, the deactivated projectors are excluded from the multi-control. The status of the registered projectors are indicated under the projector name. See the table below for status indications.

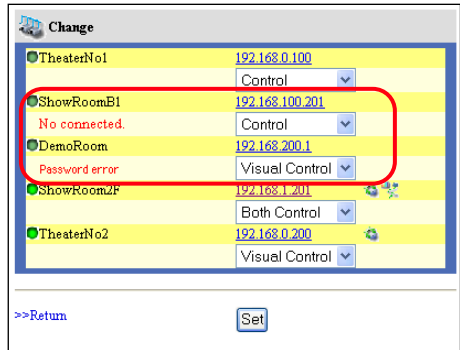

Status	Description
--------	-------------

(blank).....	The projector is connected to the network correctly
No connection.....	The projector may not connect to the network. Please check the connection and network configuration of this projector.
Password error	The login password is incorrect. The password for the multi-controlled projectors must be the same. Change password of this projector to the common password.
File Error	Not displaying the images. Check if this projector is using the Network Capture function or Network Viewer function individually, or in the stand by mode.

- ☞ If the multi-controlled projector is in the standby mode, any change is not effective except timer setting.
- ☞ It is recommended that a specified projector should be chosen for setting as a master when you use this multi-control function. The control for the multi-controlled projectors will become too complicated operation if this function is used for each projector.
- ☞ If the registered projector is not connected to the network, it will take some time to complete the multi-control operation because of waiting for the response from each registered projector.

Control

Display the control page by clicking on **Multi Control** on the multi-control page. The setting pages are constructed from 1 to 6 page and each item is indicated on the next page.



Load and apply the setting value

The control sets saved for each projector (see p.54) can be used while the multi-controlled projectors function is being used. Select a setting number from the item **Load Setting No.** with the pull-down menu button and then click **Set** button. The control values stored with selected set number for each projector will be applied to the individual projector assigned to that set. The control values will not be applied to all of the projectors under the multi-control.

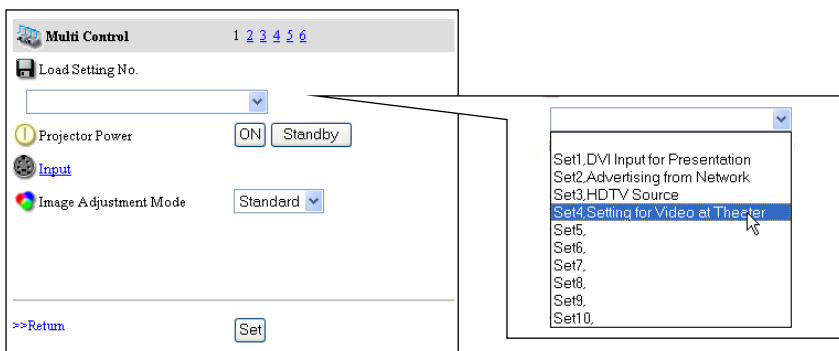

Control multi-projectors at the same time

The valid controls are shown below. Please refer to item "Control the Projector" (p.40) for further control and description. When the control button or setting button is clicked, the registered projectors for the multi-control are controlled at the same time. * These control items differ from each selected input mode and functions of the projector you use.

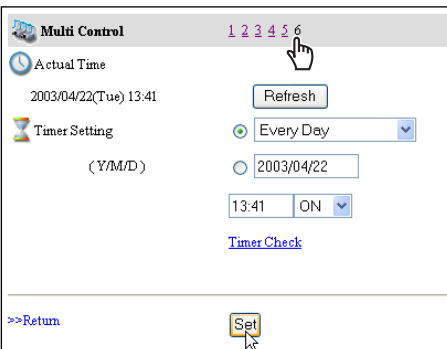
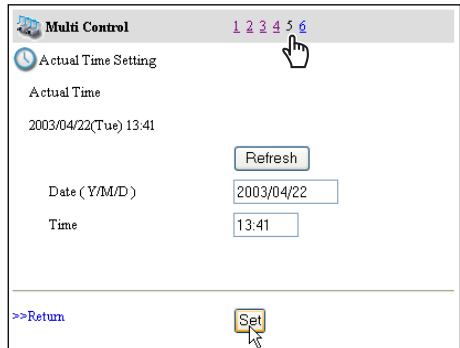
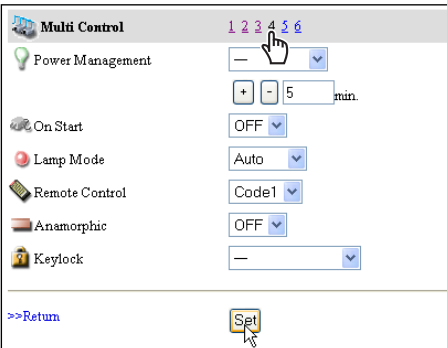
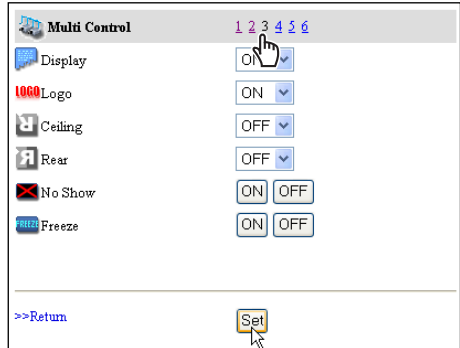
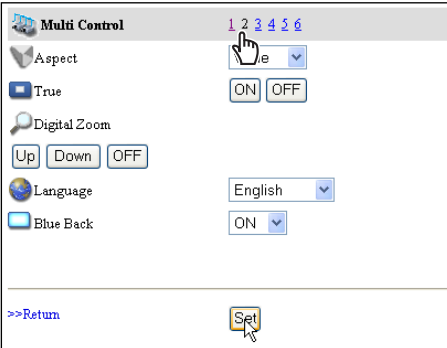

Chapter 7

Use of Serial Port

7

ENGLISH



This product provides a serial control port (RS-232C) to control the external equipment which has an RC-232C port. This function allows external equipment to be controlled by the computer through the network and the projector can be controlled by the external serial controller. Before connecting the external equipment, perform the setting “Serial port setting” described below.

Serial Port setting

This is to set up the serial port on the network unit. Display the setting page by clicking on **Serial Port** on the main menu. To communicate with external equipment correctly, communication condition must be set to the same values as that the connected equipment is using. After fixing the setting, click **Set** button*1.

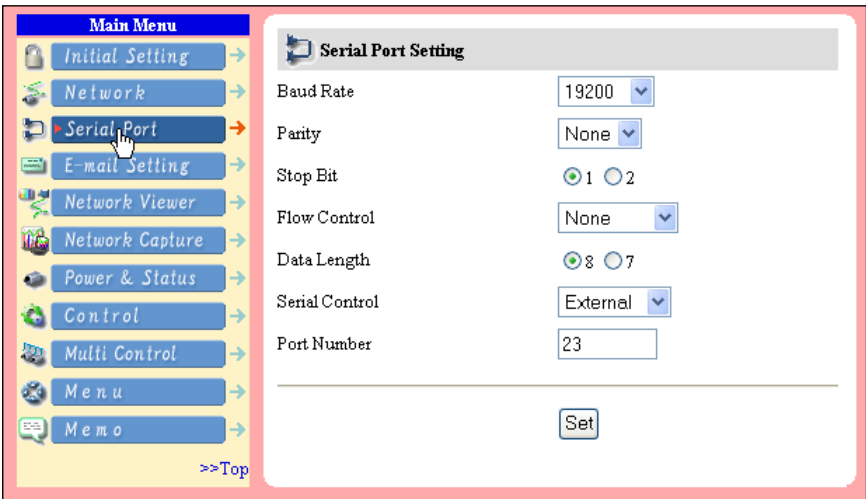

Item	Description
Baud Rate.....	Communication speed for serial port, select with the pull-down menu.
Parity.....	Parity check, the ways for error detecting of the transferred data.
Stop	Stop bit, indicates the end of communication.
Flow Control	Ways for communication flow.
Data	Indicates the length of data
Serial Control	Selects equipment to control
External	Used to select when the external equipment connected to the serial port is controlled by the computer through the LAN port.
Projector.....	Used to select when the projector is controlled by the serial controller connected to the serial port.
Port.....	Indicates the port number of TCP/IP. The default number is 23. Use the same port number specified by application. There are some reserved port number*2. If one of those port numbers is used, the alert dialog window will appear and let you know that it is an invalid port number.

Setting for controlling the equipment connected to the serial port from the computer

- Serial Control** :Selects "External"
Port :Sets according to the computer specified port no. Do not use port no. 10000*2.
Other Settings :Sets according to the communication condition of the equipment

Serial Control	External ▾
Port Number	External Projector

Setting for controlling the projector from the serial controller connected to the serial port

- Serial Control** :Selects "Projector"
Port :Not specified. Do not use port no. 10000*2.
Other Settings :Sets according to the communication condition of the serial controller

Serial Control	Projector ▾
Port Number	External Projector

Setting for controlling the projector from the computer through the LAN port

- Serial Control** :Not specified
Port :Not specified
Other Settings :Not specified

Serial Control	External ▾
Port Number	23

* The port no. of the computer must be used with 10000.

*1 This product will restart automatically when "Port" or "Serial Control" is changed and it takes about 40 seconds.

*2 The reserved port numbers are http (80), ftp (21), telnet (23), etc. The port no. 10000 is reserved to control the projector through the LAN port.

☞ Exclusive driver software for control of the external equipment is required. This product does not provide any driver software. Please consult your local dealer.

☞ There are 2 types of RS-232C serial cable, Normal(Straight) and Reverse(Cross) type. Usually, when connecting between this product and a projector or a computer, use Reverse type of serial cable. When connecting DVD player etc., use Normal type.

Control Examples

Example 1

Controlling AV equipment through network

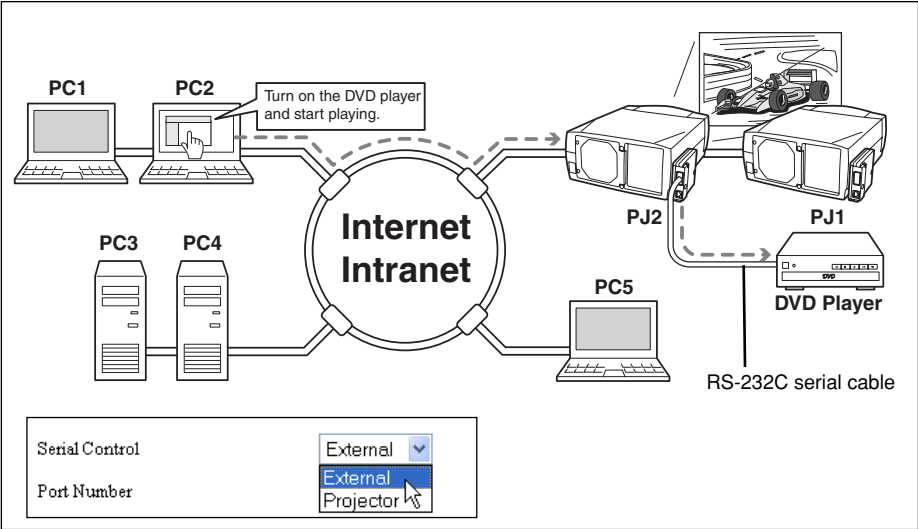

Example 2

Controlling a projector which is not on the network function through network.

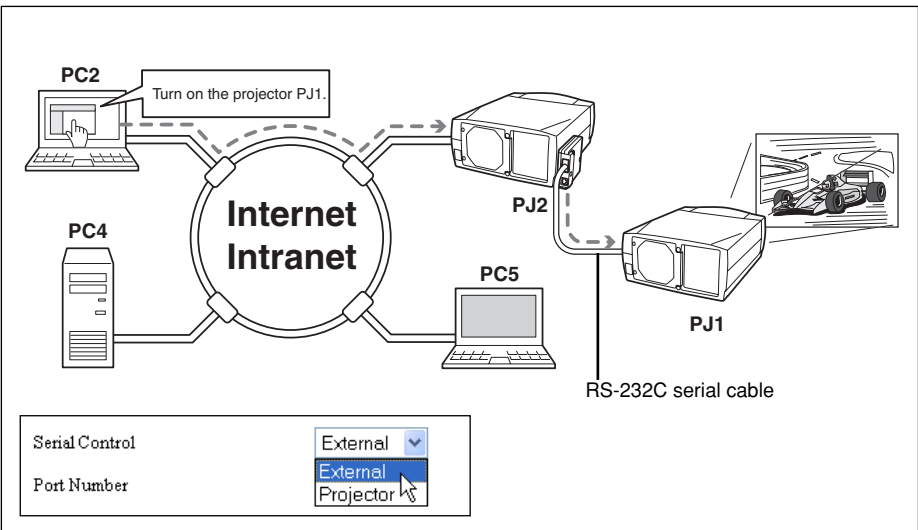

Example 3

Controlling the projector with the serial controller through the serial port (RS-232C).

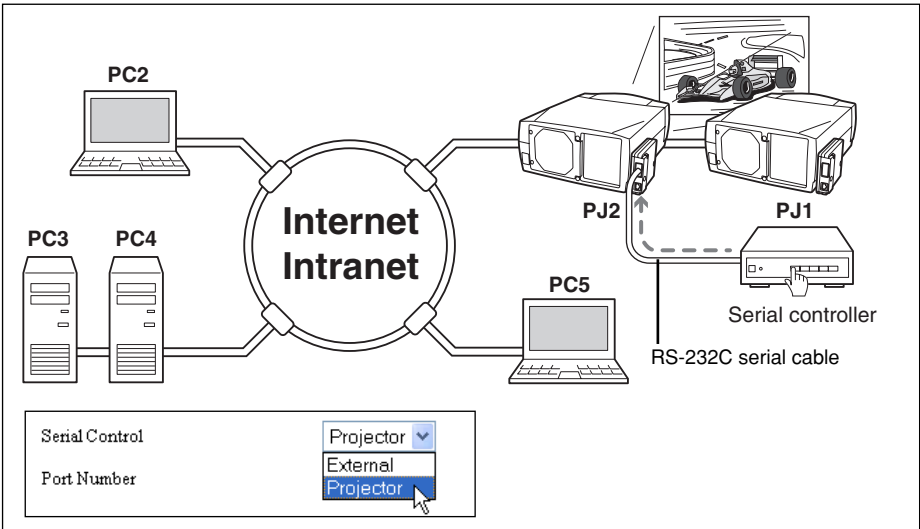

☞ Use proper serial cable depending on the connected equipment port specification. Please refer to "Port Specification" of the serial port specification of this product (p.102).

Use of Telnet

You can control the equipment connected to the serial port on the network unit and the projector itself by using the telnet application*¹ installed on your computer. The following is a control example of external equipment. The telnet application is needed to use commands*² which controls the external equipment.

Preparation

- 1 Turn the projector off with the mains switch and connect an external equipment to the serial port with an RS-232C serial cable.
- 2 Turn on the projector and external equipment.
- 3 Display the setting page by clicking on **Serial Port** on the main menu with the web browser. (p.86).
- 4 Change the serial port setting to be the same communication condition as the connected external equipment and then click **Set** button.

The following example setting is for our projector communication condition. When controlling our projector set as follows:

Baud rate19200
ParityNONE
Stop1
Flow ControlNONE
Data8
Serial ControlExternal
Port23

Control

(For example, in case of using the Telnet application of the Windows XP Professional.)

- 1 Select **Run...** submenu from **Start** menu on the computer. Type "telnet" onto the **Open** text area on the displayed window and press **OK** button.

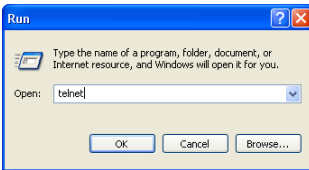

- 2 The telnet application will start and the following window will be displayed. Type as below to connect the projector.

> open 192.168.1.201 return

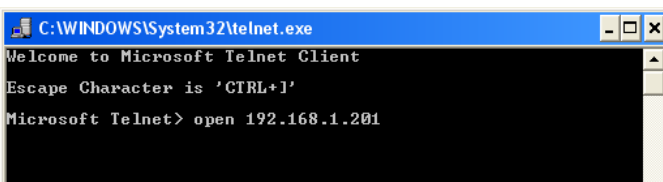

* Use the IP address assigned to the projector

- 3 When communication is established, the word "PASSWORD:" appears on the window. Type the login password* for the projector and then press "Enter" key on the keyboard. If you do not register the login password, just press "Enter" key. When the word "Hello" is replied, login has been succeeded.

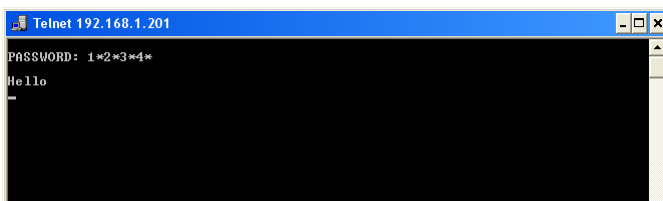

* For example, entering password [1234]

- 4 Type the commands from the key board to control the external equipment and then enter "Enter" key for termination. For example, type "C00" and enter "Enter" key.
- The extra projector will be turned on.

* "C00" is a command to turn the projector on.

To disconnect the communication, type "Ctrl" key and "]" key at the same time.

- *1 Further instructions about the telnet application, please see the on-line guide on your computer. Macintosh does not provide the telnet application.
- *2 The commands are defined by each product independently, so please consult the manufacturer or sales dealer for further information of the commands.
- * The password is a login password decided on page 20 or 30. If the authentication of the entered password is failed 4 times continuously, the communication will be disconnected automatically. Please try again for the connection.

Control the projector with Telnet

This product allows you to control the projector by using the Telnet application. Normally, it is used for controlling the external equipment connected to the serial port and also control the projector itself by specifying the telnet port no.10000.

* It is not affected by the serial port setting of the projector when using the telnet application.

In the step 2 of the previous page, enter port no. "10000" after the IP address no.
> open 192.168.1.201 10000 return

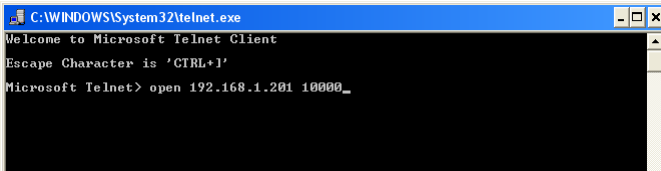

* Use the IP address assigned to the projector

After the communication is established, type the password and the command for controlling the projector and then enter "Enter" key.

The right table shows the typical command lists for controlling the our projector and please consult your local dealer for further information of another commands.

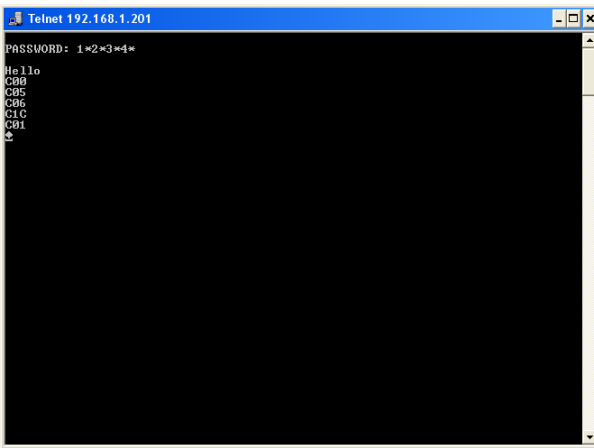

Command list table

Command	Function
C00	Turn the projector on
C01	Turn the projector off
C05	Selects input1
C06	Selects input2
C07	Selects input3
C08	Selects Network
C09	Volume up
C0A	Volume down
C0B	Mute on
C0C	Mute off
C0D	Video mute on
C0E	Video mute off
C1C	Menu display on
C1D	menu display off

8

Chapter 8 Appendix:A

Connection examples
Web browser setting
Technical data

Examples of Connection

Peer-To-Peer connection

Connecting the projector (PJ01) to the control computer (PC05) directly

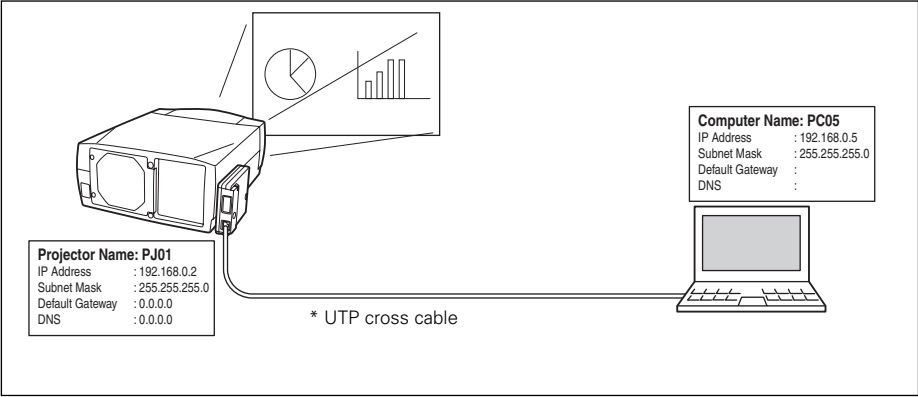

Connecting the projector (PJ01) to the control computer (PC05) via the hub.

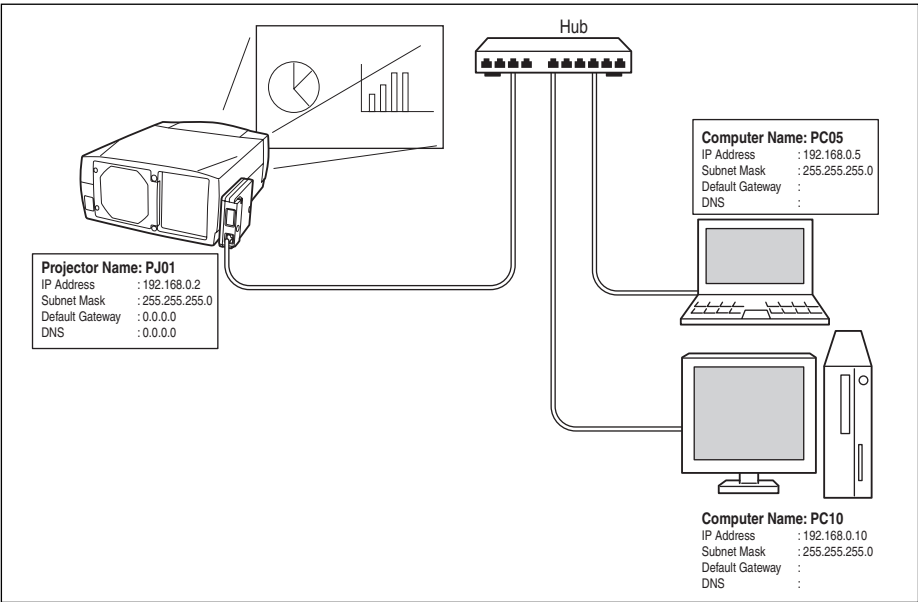

When the projector is connected to the computer directly without hub, the UTP cross cable should be used .

The gateway (Router) installed in the network

Connecting the projector (PJ01) to the control computer (PC05) via the gateway.

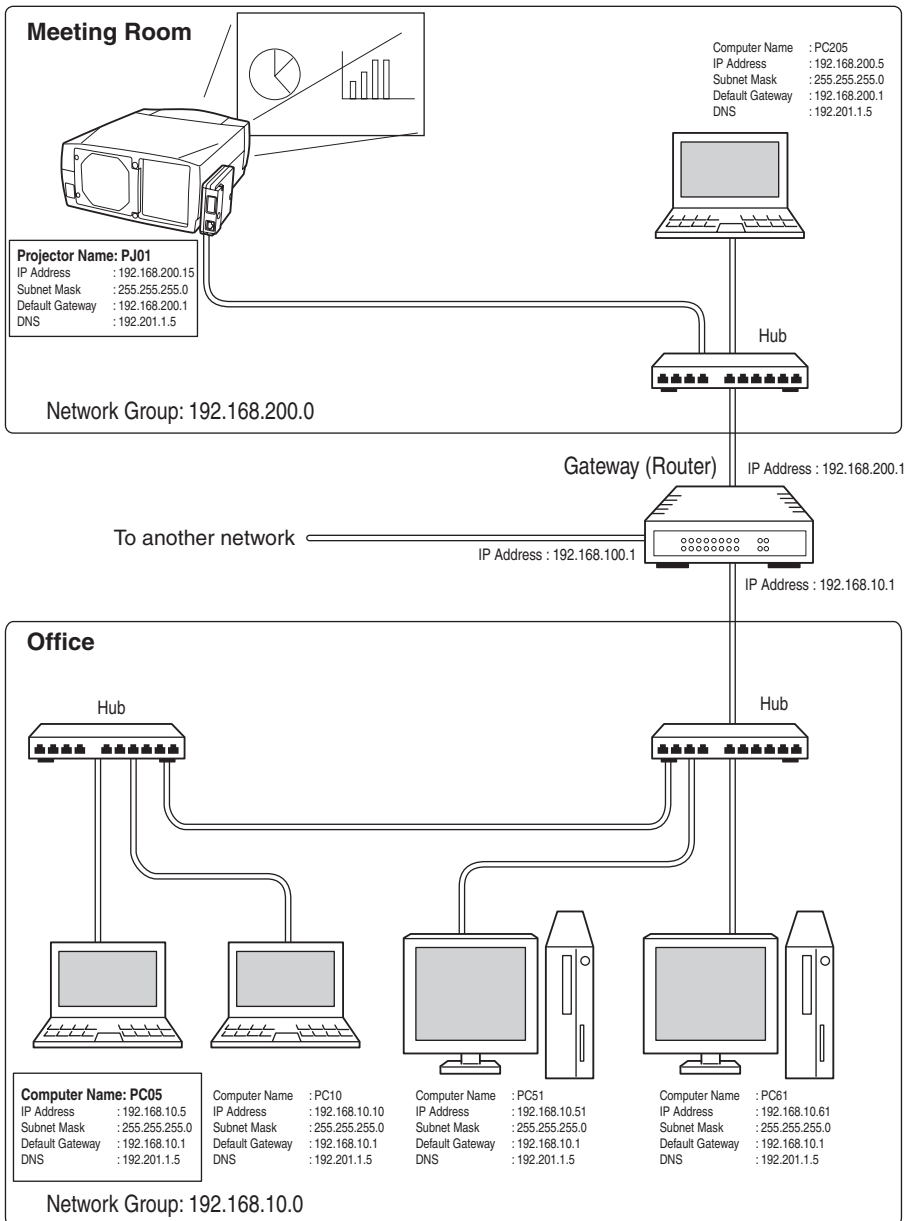

ENGLISH

Web browser setting

This product is designed to enable the projector to be set up and controlled from an Internet web browser. Depending on the preference settings of the web browser, some control functions may not be available. Please make sure that the following functions are set up properly in the web browser.

Active Script/JavaScript enable

There are some control items used with the JavaScript function in the setting pages. If the web browser is set not to use this JavaScript function, it may not control the projector properly. In this case, the following warning message will be displayed on the top of the page. To enable the JavaScript, please see further instructions on the next page.

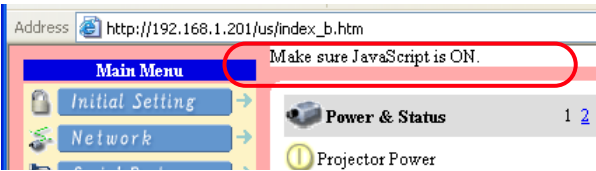
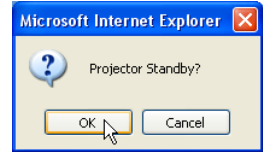

Proxy setting

In some cases, your web browser is set up to use the proxy server for the internet or intranet connection. In this case, when you install this product into the local network, you should set up the proxy setting of web browser preference correctly. Especially when connecting the projector and computer with a UTP cross cable directly, or when the network does not provide the proxy server, make sure that "not use proxy server" is set up in your web browser preference. To set up the proxy setting, please see further instructions on next page.

There are various ways to change your browser preferences depending on the version or applications. Please see the setting instructions on next page for example and also refer to on-line help of your web browser.

Examples: OS/Browsers

Windows XP Professional

Internet Explorer v.6.0

ActiveScript setting

Select the **Internet Options** menu from the **Tool** menu on the web browser and then select **Security** tab and click **Customize Level...** button. On the security setting window, scroll down and find the **Scripting** item, make sure that "Enable" is selected in item **Active Scripting**.

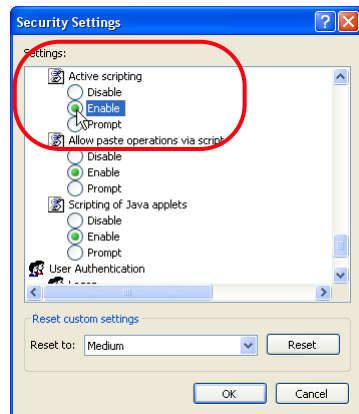
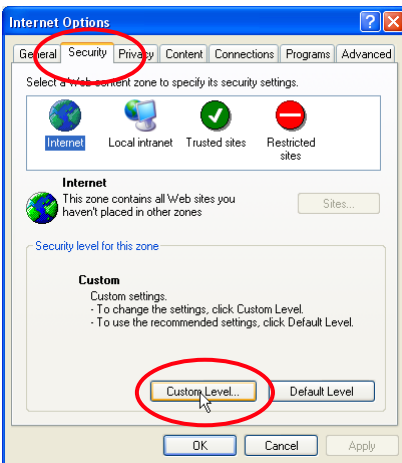

Proxy setting

Select the **Internet Options** menu from the **Tool** menu on the web browser and then select **Connection** tab and click **LAN Settings** button. Properly set up your web browser's the proxy server settings according to the local area network environment to which the projector is connected.

- Using proxy server

To use an external internet connection from the local area network, check the item **Use a proxy server** and enter the proxy server address and port correctly in the proxy settings window. For further instruction please consult your network administrator.

- Not using proxy server

Uncheck the item **Use a proxy server**.

If you connect the projector to the computer directly with UTP cross cable, this must be unchecked.

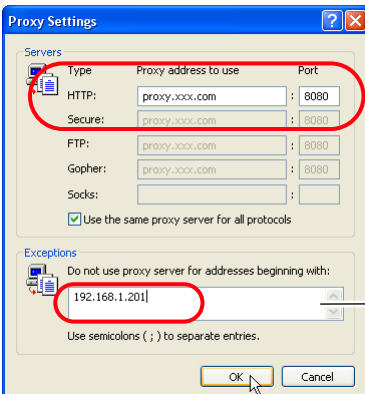
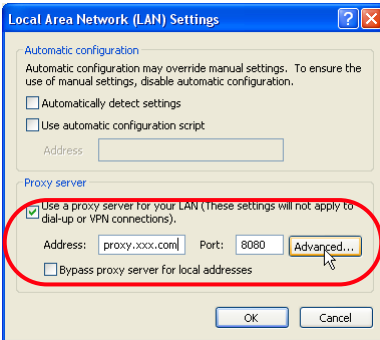

To designate proxy settings that will not use the proxy server when accessing the projector installed in the local area network, enter the IP address or domain name here.

Netscape Navigator v.7.0

JavaScript Setting

Select the **Preference** menu from the **Edit** menu on the web browser and then select the item **Advanced/Scripts & Plugins** in the **Category** column. Make sure that the **Enable JavaScript for Navigator** is checked.

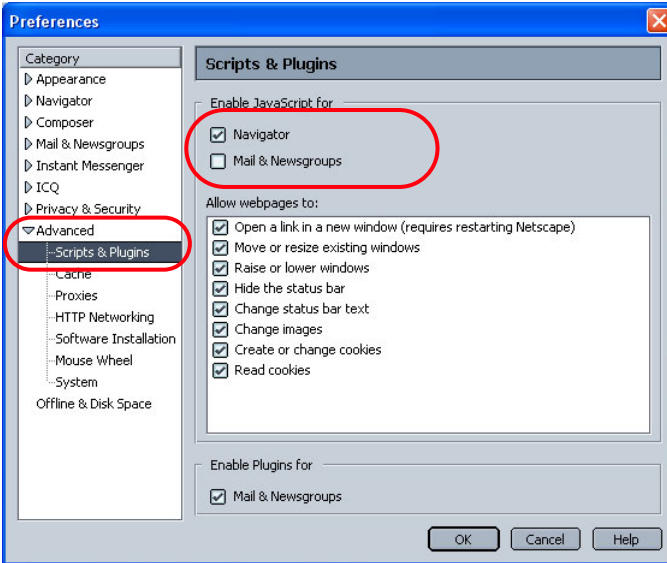

Proxy setting

Select the **Preference** menu from the **Edit** menu on the web browser and then select the item **Advanced/Proxies** in the **Category** column. Properly set up your web browser's the proxy server settings according to the local area network environment to which the projector is connected.

- Using proxy server

When you use an external internet connection from the local area network, select the item **Manual proxy configuration**. Enter the proxy server address and port number correctly on the **HTTP Proxy** item. For further instruction please consult your network administrator.

- Not using proxy server

Select the item **Direct connection to the Internet** in the proxy setting window. If you connect the projector to the computer directly with UTP cross cable, this must be selected.

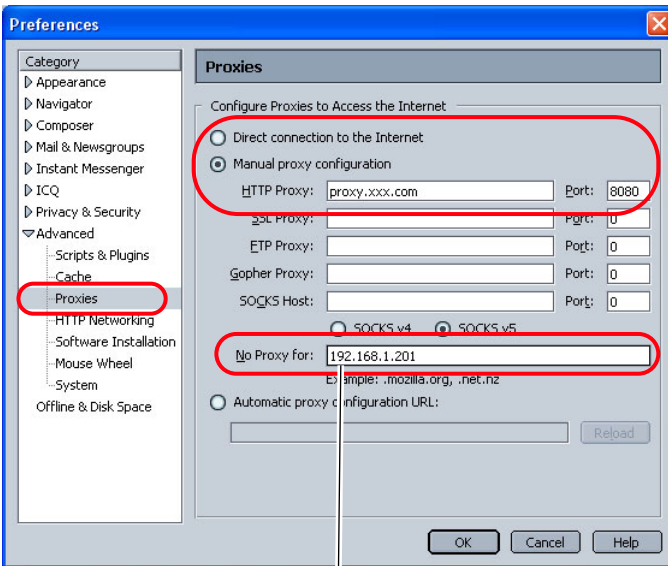

To designate proxy settings that will not use the proxy server when accessing the projector installed in the local area network, enter the IP address or domain name here.

Product specification

Type	PJ-Net Organizer (Network Unit)	
LAN interface	Applicant regulation	IEEE802.3 (10Base-T) IEEE802.3u (100Base-TX)
	Data transfer speed	10Mbps/100Mbps
	data transfer mode	Half duplex/Full Duplex
	Terminal	8-pin modular (RJ-45)
Network protocol	TCP/IP specification	TCP/IP
Serial interface	RS-232C	
	Baud rate	0.3/1.2/2.4/4.8/9.6/19.2/28.8/57.6/115.2 Kbps
	Flow control	Hardware flow control (RTS/CTS, Xon/Xoff)
	Parity check	Odd/Even
	Terminal	D sub 9-pin Male
Power source	Supplied from the projector	
Power consumption	3.0 watts	
Dimensions (W x H x D).....	5.39" x 1.18" x 4.33" (137 x 30 x 110mm)	
Weight	0.34 lbs (155 g)	
Built-in battery	Lithium battery, Type CR2032, 3.0V	
Operating temperature.....	41°F ~ 95 °F (5°C ~ 35 °C)	
Storage temperature	14°F ~ 140°F (-10°C ~ 60°C)	

* The specifications are subject to change without notice.



The CE Mark is a Directive conformity mark of the European Community (EC).

Port Specification

LAN port specification

8-pin modular connector (RJ-45)

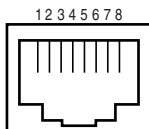

pin No.	Signal	Function
1	TX+	Transfer data (+)
2	TX-	Transfer data (-)
3	RD+	Receive data (+)
4	(not used)	
5	(not used)	
6	RD-	Receive data (-)
7	(not used)	
8	(not used)	

Serial port specification

D sub 9-pin connector (RS-232C)

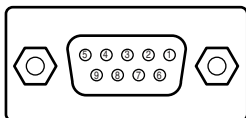

Pin No.	Signal	Function
1	CD	Carrier detection
2	RXD	Receive data
3	TXD	Transfer data
4	DTR	Data terminal ready
5	Ground	Ground
6	DSR	Data set ready
7	RTS	Request to send
8	CTS	Clear to send
9	(not used)	

Appendix:B

FAQ

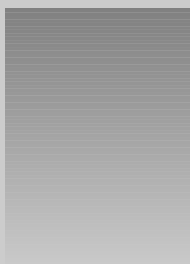

FAQ

Installation/Access

Q Why doesn't the setting page appear in my web browser?

A Following causes are possible. Please check them.

1. The projector does not connect to the network.
Check LED indicators status (☞ p.15).
 - Check the connection of LAN cable if the LINK indicator does not illuminate orange.
 - Check the network configuration of the projector if ACT indicator does not illuminate green.
2. Function "Network" in the projector is not set to "ON".
Set up by using the projector's on-screen menu (☞ p.18).
3. Wrong network configuration of the projector
Check the network configuration of the projector by using the projector's on-screen menu (☞ p.18-19).
4. Wrong network configuration of the computer.
Check the network configuration of the computer.
5. The Network Unit is used with the default setting (☞ p.18).
6. The proxy setting of the web browser is not set correctly (☞ p.96).
7. The computer does not provide TCP/IP protocol.

Q No setting page in my web browser? Is the problem in the network or in the projector? I would like to find out the problem whether it is in the network or in the projector

A Check it by the following steps

1. Disconnect the projector from the network and connect the projector and computer with the UTP cross cable directly.
2. Change network configuration of the computer and projector as shown in the example below.

(Projector setting)	(Computer setting)
IP Address : 192.168.0.2	IP Address : 192.168.0.5
Subnet Mask : 255.255.255.0	Subnet Mask : 255.255.255.0
Default gateway : 0.0.0.0	Default gateway : (blank)
DNS : 0.0.0.0	DNS : (blank)

3. Enter the projector's IP address [192.168.0.2] at "Address" column on the Web browser. [Note] Make sure that the proxy setting of your web browser is set "Not use a proxy server" (☞ p.96).
4. If the login page appears, this product is operating properly. The problems may be in the network configuration of the computer or in the network. Please try to set up the network by following item "Network configuration" (☞ p.18).
If the login page does not appear, please check for proper mounting of this product onto the projector by referring to chapter "Installation" (☞ p.16).

Q How can I restrict access from the computer.

- A**
1. Please use the password authentication function on the login page (☞ p.30).
 2. Please use the IP filtering function provided with the gateway (router) to restrict the accessing from the computer. For further information please consult your network administrator.

Q Can I access the projector installed on the company's local area network from a remote location?

- A**
- There are some ways to access to the projector in the LAN, but you must consult your network administrator.
- ☛ Use of modem
(Connect to the company's network from your home or some other places by using modem.)
 - ☛ Use of private line
(Connect to the company's network from the branch office or maintenance office by using private line.)
 - ☛ Use of internet
(Connect to the company's network from your home, branch office or some other places by using the internet.)

Q We use the DHCP/BOOTP server to assign the IP address. Is it possible to use the Network Unit in this network environment?

- A**
- Possible. As the Network Unit does not support the DHCP/BOOTP server, the fixed IP address must be configured manually. Please consult your network administrator (☞ p.21).

Q How can I install several projectors equipped with the Network Unit?

A Install and configure network one by one to avoid the IP address collision each other (☞ p.21).
To configure the IP address please see item “Network configuration” (☞ p.18).

Q How many projectors can I control with multi-control function?

A It has been designed to control up to 100 sets but it depends on the network environment.

Q Starting the Network Capture slow the response speed of the mouse pointer.

A Moving the slider of “Hardware Acceleration” to “None” may improve the above symptom.

Password/Login

Q What should I do when I forget the password?

A Select the “Password” icon from the “Network setting” menu by using the point buttons on the projector and then press **SELECT** button. The current password will appear on the screen (☞ p.20).

Q Can I register the setting page as a web browser “Favorites” or “Bookmarks”?

A Please add “Login” page to your “Favorites” or “Bookmarks”. Do not add the specified setting page because it will not be able to perform the password authentication correctly.

Operation

Q Why can't I change the controls in the setting page with web browser?

A Please make sure the projector is turned on. If it is in the standby mode, the setting is not effective to the projector. To control the projector with a web browser, the projector must be in the powered-on condition. Also, projectors registered for multi-control cannot have any controls changed if they are in standby mode. But timer and clock settings are always effective, even for projectors in standby mode.

Q Why does it sometimes take a lot of time to complete the page display?

A The display speed of the page depends on the network environment in which both the projector and computer are placed. It may take much time to complete the page display if network traffic is heavy. Please consult your network administrator. By changing the preference of your web browser to "not show pictures", you may have page display more quickly at the heavy network traffic. Please see the browser's on-line help for further information. Also you can select the Text mode for displaying pages quickly (☞ p.26).

Q I use many of the projectors in the network. How can I use names of the projectors to recognize each projector instead of IP addresses?

A You can manage the projectors with nicknames instead of the IP address. Please see chapter "Controlling the Multi-Projectors" for further information (☞ p.79).

By registering the projector name and IP address with the DNS server, it can be accessed with the nickname from the any computer referred to the DNS server. Please consult your network administrator (☞ p.32, 81).

Q How many numbers of the E-mail address can I register in the E-mail setting page.

A You can register up to 10 addresses.

Q Why am I not receiving E-mail alert messages?

A Make sure that the registered E-mail address and SMTP server address are correct. If the SMTP server is located in your LAN (Local Area network), the address should be set to the SMTP server in your LAN. The SMTP server located outside of your LAN may not be available for security reason. For further information please contact your network administrator (☞ p.33).
It may be required for the authentication depending on the SMTP server. This product does not support this kind of SMTP server.

Others

Q Can I develop a driver to control external serial equipment?

A This product does not provide any driver software. To control the external equipment connected to the extra serial port, it should be required to clarify the commands and communication condition defined by each equipment. If they are clarified, it can be controlled by using the Telnet application installed on your computer. Please see chapter "Use of telnet" (☞ p.90).

Q Can I control the projector by using the telnet application?

A Possible. Please refer to the item "Control the projector with telnet" (☞ p.92).

Q Can I update the firmware of the Network Unit.

A It is possible to update the firmware through the network. It is required to have a special tool for the updating. For further information please consult your local dealer. The version number of the firmware is indicated on the lower part of the "Initial Setting" page.

Initial Setting		1 2
Language	English	
Model Name	XP50/55	
Password	*****	
Temperature	Fahrenheit	

4.081

Q What are the rules for IP address assignment?

A If the network is constructed with TCP/IP protocol, a unique IP address is required for each piece of network equipment. The following are basic rules of the assignment.

Rule1

Do not configure the same IP address to the network equipment in the same network group. Each piece of equipment must be assigned a unique IP address.

If the IP address is set [192.168.x.x], the Subnet Mask should be set [255.255.255.0] for example.

Rule2

The start address [xxx.xxx.xxx.0] and the last address [xxx.xxx.xxx.255] of the IP address must not be assigned to any other equipment. These address numbers are reserved.

Rule3

The IP address must correlate to a network number. If network numbers are different between the equipment, they cannot establish communications each other. In this case, the router is placed in the networks to make the routing.

Q What is the MAC address assigned to the Network Unit?

A The MAC address is indicated on the case back as the below.

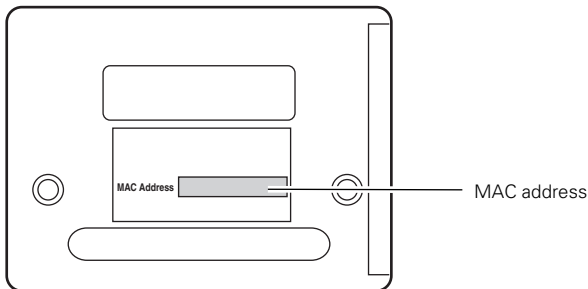

Network Capture

Q Why doesn't the computer screen appear on the projected screen?

- A**
1. Make sure that the input mode of the projector is "Network".
 2. Make sure that the Network Capture icon on the task bar of the computer is active (☞ p.60).
 3. Check the parameter determination (☞ p.61).
Make sure that the numbers of the capture port and mouse port are the same as the projector's port numbers. The default port numbers are 9000 and 9001 respectively. If the alert message "Invalid Port No." appears, your computer may be using these port numbers already. In this case, use another port numbers.
 4. Check the IP address of the projector is registered to the computer correctly (☞ p. 63).
 5. Make sure that your computer is not using the firewall function. The network unit may not be able to use the port due to this firewall function. In this case, please turn off this function temporarily. There are also some port limitations on the network equipment such as router. Please consult your network administrator.

Network Viewer

Q Images from the file server don't appear on the screen?

- A**
1. Make sure that the input mode of the projector is "Network".
 2. Check the account setting of the file server (☞ p.72).
 3. The files in the file server must be optimized JPEG files and converted by using the File Converter 1. Please check data format.(☞ p.65)
 4. There are several limitations for image file name and program name. Please check file names and program names (☞ p.71).
 5. Make sure that your computer is not using the firewall function. The network unit may not be able to use the port due to this firewall function. In this case, please turn off this function temporarily. There are also some port limitations on the network equipment such as router. Please consult your network administrator.

Q I cannot make a new program file.

- A** Check your account of the ftp server. You must have a mode "Write enable" for its account.

File Converter 1

Q What kind of image formats can I convert?

A The File Converter 1 enables to convert to the JPEG format from the following image format.

Bitmap format (.bmp)

JPEG format (.jpeg .jpg)

File Converter 2

Q Sometime I have the white frame images converted by the File Converter 2.

A It may have images with white frame due to the paper margin of the print driver depending on the image data.

Printed in Japan

1AA6P1P3994-- (IDJW)

SANYO Electric Co. Ltd.

Download from [Www.Somanuals.com](http://www.Somanuals.com). All Manuals Search And Download.

Free Manuals Download Website

<http://myh66.com>

<http://usermanuals.us>

<http://www.somanuals.com>

<http://www.4manuals.cc>

<http://www.manual-lib.com>

<http://www.404manual.com>

<http://www.luxmanual.com>

<http://aubethermostatmanual.com>

Golf course search by state

<http://golfingnear.com>

Email search by domain

<http://emailbydomain.com>

Auto manuals search

<http://auto.somanuals.com>

TV manuals search

<http://tv.somanuals.com>