

## **User guide**

### **Gas cooktops**

CG603 and CG903 models

NZ AU



# Contents

Introduction	2
Safety and warnings	3
Using your cooktop	4
Care and cleaning	8
Troubleshooting	10
Warranty and service	11
Gas rate summary	12

***Important!***

***SAVE THESE INSTRUCTIONS***

## 2 Introduction

### About your new cooktop

Thank you for buying a Fisher & Paykel gas cooktop. Now that it is installed and ready to use, you will want to know everything about it to make sure you get excellent results right from the start. This guide introduces you to all its special features. We recommend you read the whole guide before using your new cooktop, for both safety and cooking success.

For more information, go to [www.fisherpaykel.com](http://www.fisherpaykel.com)

### Before using your new cooktop

Before using your new cooktop, please:

- Read this user guide, taking special note of the 'Safety and warnings' section following.
- Plug the cooktop into the electricity supply and turn it on so the electronic ignition will work.

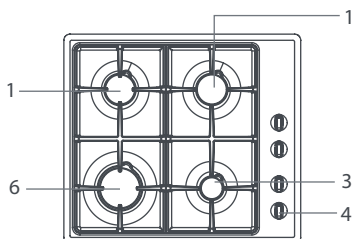

Fig.1 CG603 with rapid burner

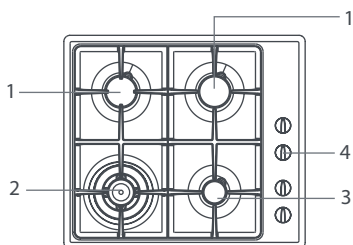

Fig.2 CG603 with wok burner

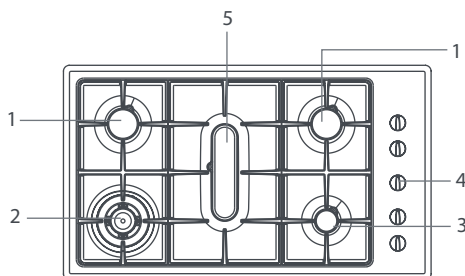

Fig.3 CG903

- 1 Semi-rapid burner
- 2 Wok burner
- 3 Auxiliary burner
- 4 Cooktop controls
- 5 Fish burner
- 6 Rapid burner

## ! WARNING!



### Hot Surface Hazard

This appliance becomes hot during use.

Do not touch the cooktop components, burners, trivets/pan supports or the stainless steel base when hot.

Before cleaning, turn the burners off and make sure the whole cooktop is cool.

Failure to do so could result in burns and scalds.

## ! WARNING!



### Explosion Hazard

Do not store flammable materials such as gasoline near the cooktop.

Do not spray aerosols near the cooktop during use.

Failure to do so may result in death or electrical shock.

## ***Important safety precautions***

- Household appliances are not intended to be played with by children.
- Children, or persons with a disability which limits their ability to use the appliance, should have a responsible person to instruct them in its use. The instructor should be satisfied that they can use the appliance without danger to themselves or their surroundings.
- This appliance should be connected to a circuit that incorporates an isolating switch providing full disconnection from the electricity supply.
- Do not stand or place heavy objects on this appliance.
- Do not use an asbestos mat or decorative covers between the flame and the saucepan as this may cause serious damage to your cooktop.
- Do not place aluminium foil or plastic dishes on the cooktop burners.
- Do not let large saucepans or frying pans overlap the bench as this can deflect heat onto your benchtop and damage the surface.
- Do not let large saucepans, frying pans or woks push any other pans aside. This could make them unstable or deflect heat onto your benchtop and damage the surface.
- Do not use a steam cleaner for cleaning this cooktop.
- Saucepan handles may be hot to touch. Ensure saucepan handles do not overhang other gas burners that are on. Keep handles out of reach of children.
- If the electrical supply cord is damaged, it must only be replaced by an authorised person. Ensure that the electrical connection plug is accessible after installation.
- Where this gas cooktop is installed in marine craft or in a caravan, it shall not be used as a space heater.
- The use of a gas cooking appliance results in the production of heat and moisture in the room in which it is installed. Ensure the kitchen is well ventilated. Keep natural ventilation holes open or install a mechanical ventilation device (mechanical extractor hood). Prolonged intensive use of the appliance may call for additional ventilation, for example opening of a window, or more effective ventilation, for example increasing the level of mechanical ventilation where present.

## 4 Using your cooktop

### Lighting the cooktop

- 1 Choose the control knob for the burner you want to use.
- 2 Press the knob down gently and turn it anticlockwise to the High position. The electrodes on all the burners will spark.

*Flame failure models only:* Hold down the knob for approximately five seconds after the burner has lit. Releasing the knob too soon will extinguish the flame.

- 3 Adjust the flame anywhere between the High and Low positions. Do not adjust the flame between High and Off.

Note:

- If the burner does not light within 15 seconds, turn the control knob off and wait at least one minute before trying again.

### If the cooktop does not light

If the cooktop does not light, check that:

- The cooktop is plugged in and the electricity is switched on.
- The gas is turned on.
- The electrodes are sparking.

If the electrodes are not sparking, they may be dirty or wet. Clean them with a toothbrush and methylated spirits, as shown in Fig. 6.

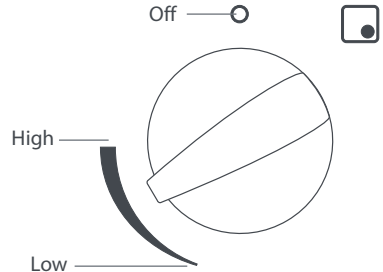

Fig.4 Non-jet cooktop controls  
(knobs may vary from those illustrated)

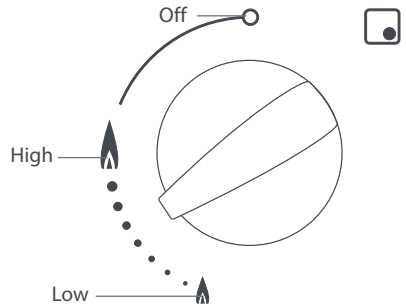

Fig.5 Jet cooktop controls  
(knobs may vary from those illustrated)

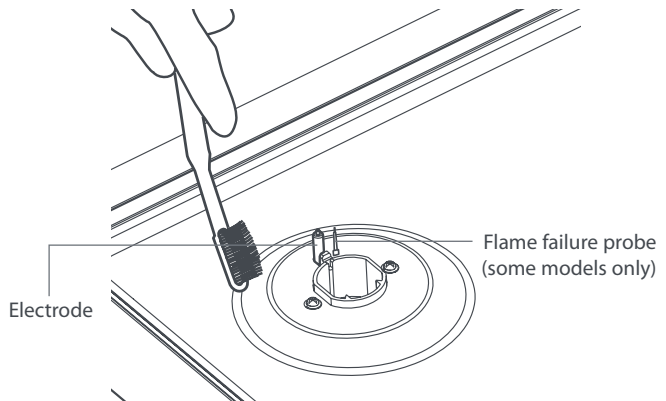

Fig.6 How to clean an electrode

## If the flame is irregular

If the flame is yellow or irregular, check that the burner parts, including the burner cap, are:

- Clean and dry.
- Positioned correctly as shown in Fig. 8.

See also 'Troubleshooting'.

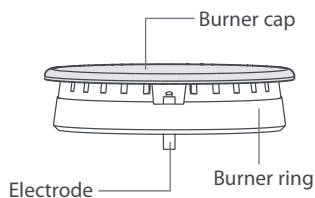

Fig.7 Burner parts

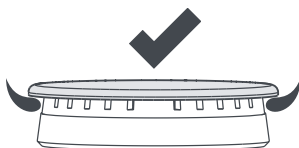

Fig.8 Correct assembly of burner parts

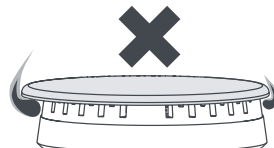

Fig.9 Incorrect assembly of burner parts, showing irregular flames

## Electricity failure

If there is an electricity failure, you can still use your cooktop. Light the burners by holding a match close to the side of the burner and turning the control knob to the High position. Wait until the flame is burning evenly before adjusting.

## Flame failure safety feature (some models only)

Some cooktop models have a flame failure probe (see Fig. 6).

This safety feature cuts off the gas supply to the burner if the flame is blown out.

When lighting the burner on flame failure models, hold down the knob for approximately five seconds after the burner has lit. Releasing the knob too soon will extinguish the flame.

If the flames are accidentally extinguished, turn off the burner and do not try to light it again for at least one minute (to allow the gas to disperse).

## 6 Using your cooktop

### General guidelines

To get the best out of your cooktop, follow these simple suggestions:

- Use saucepans with thick flat bottoms. Food in a saucepan with an uneven bottom will take longer to cook.



Fig.10 Efficient and inefficient saucepan bottoms

- Do not let large saucepans or frying pans overlap the bench as this can deflect heat onto your benchtop and damage the surface.
- Always make sure saucepans are stable. Using very heavy saucepans may bend the trivet/pan support or deflect the flame.
- When you need to boil, simmer or fry food, first set the temperature to the High position. Once the food is boiling, reduce the temperature to maintain a steady heat to cook your food thoroughly. Doing this will reduce the cooking time.
- For auxiliary and semi-rapid burners, pans should be 12 cm (5 in.) or larger in diameter.
- For rapid burners, pans should be 18-26 cm (7-10 in.) in diameter.
- The fish burner is designed to be used with a 'fish kettle' or griddle approximately 40 cm (16 in.) long.
- A fish kettle used on the fish burner is also useful for steaming long vegetables like corn cobs, Chinese broccoli, long beans, and asparagus.

### Using a wok

- Use your wok only on the wok burner. The trivet/pan support is shaped to take a traditional wok with a round base.
- You can also use a wok stand. Make sure the stand fits securely on the four fingers of the trivet/pan support, and is stable.
- Do not use a wok larger than 45 cm (18 in.)
- The wok burner is designed to be used with a wok but may be used with pans 18-26 cm (7-10 in.) in diameter, with care.



## Using a SimmerMat (if supplied)

A SimmerMat helps control the temperature of the cooking surface for gentle cooking or the long slow simmering that is needed for some foods. **Use at low heat only.**

### To simmer

First bring the food to the boil over high heat. Then turn the burner off and carefully place the SimmerMat over the burner on the trivet/pan support, with the points facing upward. Re-light the burner, turn to Low and place your saucepan on top of the SimmerMat.

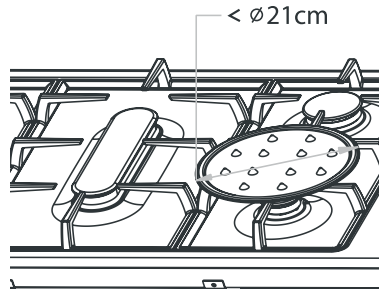

Fig.11 Only use the SimmerMat on the Auxilliary burner

## Using a griddle (if supplied)

### Cooking with a griddle

A griddle is ideal for cooking a variety of foods. The surfaces of a cast-iron griddle will become more and more non-stick as cooking oils become baked in. This 'seasoning' process can be started by coating both surfaces of the griddle with cooking oil and baking in the oven at 150 °C (300 °F) for about an hour.

- Heat the griddle for a few minutes before using.
- Brush the food, not the griddle, with oil, to reduce splatter and smoking.
- Cook steak and vegetables at high temperatures on the ribbed side of the griddle. Turn the steak only once, about halfway through the cooking time. To test, press the surface of the steak. The softer the meat is, the 'rarer' or less well done it will be.
- Griddle scones, pancakes, pikelets, polenta and eggs are best cooked slowly at medium to low temperatures on the flat side of the griddle.

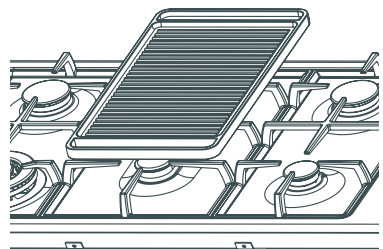

Fig.12 Only use the griddle on the Fish burner

## **Important!**

*Prolonged cooking with the griddle at high temperatures may damage the cooktop.*

### Cleaning a cast-iron griddle

- Leave the griddle to cool before cleaning. Scrape away any food residue and wash in warm soapy water.
- Do not scour to the bare metal when cleaning the griddle or you will remove the non-stick coating that has built up during cooking.
- Dry the griddle thoroughly and wipe with a thin coating of cooking oil to prevent rust forming, especially when the griddle is new.

## General cleaning advice

- Clean the cooktop regularly – do not let stains become burnt on.
- Use soapy water and a soft sponge or cloth (use the mildest cleaner that will do the job). Do not use abrasive cleaners, steel soap pads or sharp objects on stainless steel.
- Soak stains under a soapy cloth.
- Clean brushed stainless steel in the direction of the grain.
- Rinse with clean water to ensure no cleaner residue is left (when heated this can stain the cooktop).
- Dry thoroughly to avoid leaving water marks. For extra shine on stainless steel, use a stainless steel polish.
- You can wash trivets/pan supports in the dishwasher.
- Clean the burner parts in hot soapy water. Make sure you keep the holes and slots clear.
- Thoroughly dry the burner parts. The flames will be irregular if the burner ring is not completely dry.
- Clean electrodes with a toothbrush and methylated spirits.
- Do not clean cooktop parts in a self-cleaning oven.
- Do not use a steam cleaner.
- After cleaning, replace the parts correctly on the cooktop, as shown in Fig. 13. When replacing the burner rings, turn the rings until the positioning teeth are placed correctly.
- For stubborn stains, see the 'Cleaning chart'.

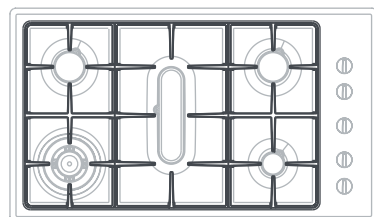
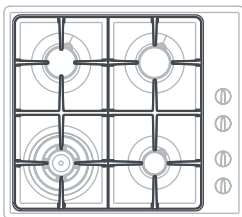
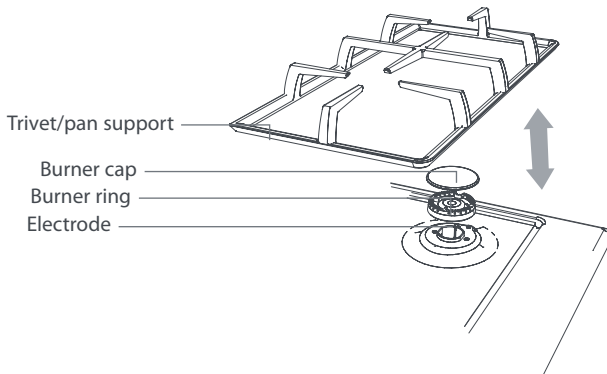

Fig.13 After cleaning, replace the parts correctly

## Cleaning chart

Cooktop part	Cleaning	Important
<b>Trivets/pan supports, burner caps and enamel surfaces</b>	<ul style="list-style-type: none"> <li>▪ Hot soapy water and nylon scourer.</li> <li>▪ Soaking in a solution of biological clothes washing detergent.</li> <li>▪ Mild abrasive cream cleaners.</li> <li>▪ Fume-free or heavy-duty oven cleaners (follow manufacturer's instructions).</li> </ul>	<p>Always allow cooktop parts to cool completely before cleaning them.</p> <p>Always apply minimal pressure with abrasive cleaners.</p> <p>Remove spills as soon as the cooktop is cool to avoid the soil becoming burnt on.</p>
<b>Burner parts</b>	<ul style="list-style-type: none"> <li>▪ Hot soapy water.</li> <li>▪ To clear the holes use a stiff nylon brush or wire eg straight-ended paper clip.</li> <li>▪ Mild abrasive cream cleaners.</li> </ul>	<p>Reassemble the burner parts correctly.</p>
<b>Control knobs</b>	<ul style="list-style-type: none"> <li>▪ Hot soapy water and a soft cloth.</li> </ul>	
<b>Stainless steel surfaces</b>	<ul style="list-style-type: none"> <li>▪ Soak stains under a hot soapy cloth, rinse and dry thoroughly.</li> <li>▪ Hard water spots can be removed with household white vinegar.</li> <li>▪ Non-abrasive stainless steel cleaners. Regular use of a stainless steel polish will reduce fingerprints and other marks.</li> <li>▪ Heavy soiling can be removed with fume-free or heavy-duty oven cleaner (follow manufacturer's instructions).</li> </ul>	<p><b>Never use harsh/abrasive cleaning agents as they will damage the stainless steel finish.</b></p> <p>Chlorine or chlorine compounds in some cleaners are corrosive to stainless steel and may damage the appearance of your cooktop. Check the label on the cleaner before using.</p> <p>The graphics are etched onto the steel by laser and will not rub off.</p>
<b>Electrodes</b>	<ul style="list-style-type: none"> <li>▪ Toothbrush and methylated spirits.</li> </ul>	<p>A dirty or wet electrode will prevent the burner lighting efficiently.</p>

## Troubleshooting chart

Problem	Possible solutions
<b>My cooktop does not light</b>	<p>Check the cooktop is plugged in and the electricity is switched on. Check the gas supply valve is turned on and the supply to the house is working. You should hear the gas when you turn a burner on.</p> <p>The electrodes may be dirty. Clean them with a toothbrush and methylated spirits.</p> <p>The burner parts may not be located properly. Check the assembly and make sure the burner cap is sitting flat.</p>
<b>My burner flames are yellow or hard to start</b>	<p>The burner parts may not be located properly. Check the assembly and make sure the burner cap is sitting flat.</p> <p>If you use bottled gas this may indicate you are getting near the end of the bottle.</p> <p>Check the burner parts are clean and dry.</p> <p>The gas pressure may not be at the correct level. Check with your service person or installer.</p> <p>Your cooktop may not be set up for the gas you are using. Check this with your service person or installer.</p>
<b>One of my burners has an uneven flame</b>	<p>Check the burner parts are clean and dry. Check the assembly and make sure the burner cap is sitting flat.</p>
<b>My cooktop goes out when I let go of the knob</b>	<p>Some cooktops have a safety feature called 'flame failure'. Hold down the knob for approximately five seconds after the burner has lit. Releasing the knob too soon will extinguish the flame. See the 'Flame failure safety feature' in 'Using your cooktop'.</p>
<b>The flame goes out at low settings</b>	<p>The gas supply pressure may be low. Check this with your service person or installer.</p> <p>The low setting may have been adjusted incorrectly. Check this with your service person or installer.</p>
<b>My burners do not turn down much (when running on bottled gas or LPG)</b>	<p>Your cooktop may not have been adjusted correctly. Check this with your service person or installer.</p>
<b>The flame tips are very yellow</b>	<p>Call your service person to service the cooktop.</p>
<b>There are objectionable odours</b>	<p>Call your service person to service the cooktop.</p>
<b>The flame appears to lift off the burner</b>	<p>Call your service person to service the cooktop.</p>
<b>There is an electricity failure</b>	<p>If there is an electricity failure, you can still use your cooktop. Light the burners by holding a match close to the side of the burner and turning the control knob to the High position. Wait until the flame is burning evenly before adjusting.</p>

## Before you call for service or assistance ...

Check the things you can do yourself. Refer to the installation instructions and your user guide and check that:

- 1 Your product is correctly installed.
- 2 You are familiar with its normal operation.

If after checking these points you still need assistance, please refer to the Service & Warranty book for warranty and after-sales service details or contact us through our website:

**[www.fisherpaykel.com](http://www.fisherpaykel.com)**

## Product details

Fisher & Paykel Ltd

Model \_\_\_\_\_ Serial no. \_\_\_\_\_

Date of purchase \_\_\_\_\_ Purchaser \_\_\_\_\_

Dealer \_\_\_\_\_ Suburb \_\_\_\_\_

Town \_\_\_\_\_ Country \_\_\_\_\_















**Copyright © Fisher & Paykel 2005. All rights reserved.**

The product specifications in this booklet apply to the specific products and models described at the date of issue. Under our policy of continuous product improvement, these specifications may change at any time. You should therefore check with your Dealer to ensure this booklet correctly describes the product currently available.

**[www.fisherpaykel.com](http://www.fisherpaykel.com)**

NZ AU

Gas cooktops user guide

Published: 11/2005

Part No. 599276 A

## Free Manuals Download Website

<http://myh66.com>

<http://usermanuals.us>

<http://www.somanuals.com>

<http://www.4manuals.cc>

<http://www.manual-lib.com>

<http://www.404manual.com>

<http://www.luxmanual.com>

<http://aubethermostatmanual.com>

Golf course search by state

<http://golfingnear.com>

Email search by domain

<http://emailbydomain.com>

Auto manuals search

<http://auto.somanuals.com>

TV manuals search

<http://tv.somanuals.com>