

*Fisher & Paykel*

Gas cooktop

CG903ML & CG903MLD models

**User guide**



Introduction	3
Safety and warnings	4
Using your cooktop	6
Cooking guidelines	9
Care and cleaning	12
Sound preference settings	16
Troubleshooting	18
Alert codes	20
Warranty and service	23

## ***Important!***

### **SAVE THESE INSTRUCTIONS**

*The models shown in this user guide may not be available in all markets and are subject to change at any time. For current details about model and specification availability in your country, please visit our local website listed on the back cover or contact your local Fisher & Paykel dealer.*



## Introducing your cooktop

Congratulations on your new purchase. This cooktop is the ultimate in gas cooking, giving you the speed of gas, the precision and simplicity of electronic control, and the easy-care elegance of a ceramic glass surface.

Your cooktop has a number of features, including a constant flame safety system, automatic cool-down responses, hot warning indicators, and audio and visual feedback through the electronic interface and built-in speakers.

## Before using your cooktop

- Make sure the installer has completed the installation checklist in the installation instructions.
- Read this guide, taking special note of the 'Safety and warnings' section.
- A heat-resistant removable sticker on the glass has been provided as a quick reference guide. When you no longer need it, it can be easily peeled off.

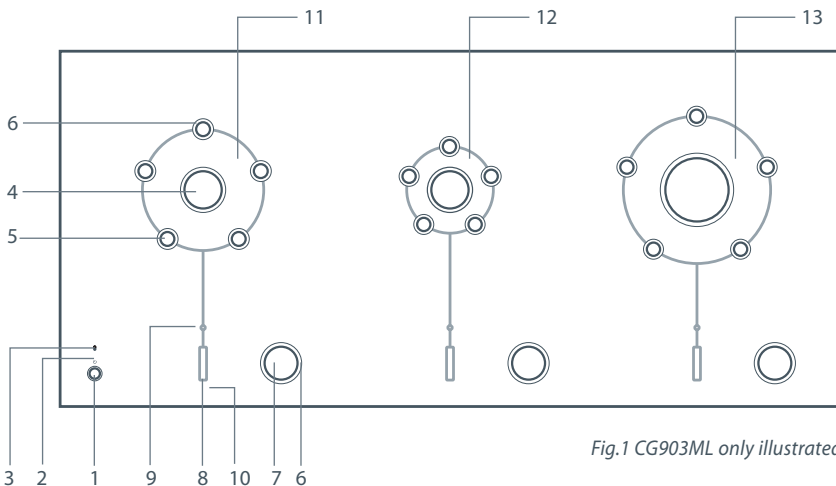

Fig.1 CG903ML only illustrated

- |                       |                        |
|-----------------------|------------------------|
| 1 On/Off power button | 8 Control display      |
| 2 On/Off light        | 9 Burner-ready light   |
| 3 Keylock light       | 10 Hot warning light   |
| <i>Pan supports:</i>  |                        |
| 4 Burner head         | 11 Medium Aero™ burner |
| 5 Pan support pins    | 12 Small Aero™ burner  |
| 6 Trim rings          | 13 Wok Aero™ burner    |
| 7 Control dial        |                        |

## 4 Safety and warnings

Your safety is important to us. Please read this information before using your cooktop.

### WARNING!



#### **Explosion Hazard**

Do not use or store flammable materials such as gasoline near the appliance. Do not spray aerosols in the vicinity of this appliance while it is in operation. Failure to follow this advice may result in injury or death.

### WARNING!



#### **Poisoning Hazard**

Never use this appliance as a space heater to heat or warm the room. Doing so may result in carbon monoxide poisoning and overheating of the appliance. Failure to follow this advice may result in poisoning or death.

### WARNING!



#### **Electrical Shock Hazard**

If the surface is cracked, switch the power to the appliance off to avoid the possibility of electric shock. Call your Authorised Service Centre or Customer Care. Failure to follow this advice may result in electrical shock.

### WARNING!



#### **Hot Surface Hazard**

During use, this appliance becomes hot. Keep children away. Do not touch the appliance components, burners, pan supports or the ceramic glass when hot. Before cleaning, turn the burners off and make sure the whole appliance is cool. Pan handles may be hot to touch. Ensure handles do not overhang other gas burners that are on. Keep handles out of reach of children. Failure to follow this advice could result in burns and scalds.

## ***Important safety instructions***

- *Use this appliance only for its intended purpose as described in this user guide.*
- *Do not modify this appliance.*
- *Household appliances are not intended to be played with by children.*
- *Children, or persons with a disability which limits their ability to use the appliance, should have a responsible person to instruct them in its use. The instructor should be satisfied that they can use the appliance without danger to themselves or their surroundings.*
- *This appliance should be connected to a circuit that incorporates an isolating switch providing full disconnection from the power supply.*
- *Before using the appliance, ensure that all burners have been assembled correctly.*
- *Do not operate the appliance with any of the burner heads removed.*
- *We recommend raising the pan supports first, then placing the pan on them (the pan supports are not primarily designed for lifting pans).*
- *Do not stand or place heavy objects on this appliance.*
- *Do not use an asbestos mat between the flame and the pan as this may cause serious damage to your appliance.*
- *Do not place aluminium foil or plastic dishes on the burners.*
- *Do not let pans overlap the edge of the appliance as this can deflect heat onto your benchtop and damage the surface.*
- *Do not let pans push any other pans aside. This could make them unstable, or deflect heat onto nearby walls or the benchtop.*
- *Do not use a steam cleaner for cleaning this appliance.*
- *If the power supply cable is damaged, it must only be replaced by an authorised person. Ensure that the electrical connection plug is accessible after installation.*
- *Where this appliance is installed in marine craft or in a caravan, it shall not be used as a space heater.*
- *The use of a gas cooking appliance results in the production of heat and moisture in the room in which it is installed. Ensure the kitchen is well ventilated. Keep natural ventilation holes open or install a mechanical ventilation device (mechanical extractor hood).  
Prolonged intensive use of the appliance may call for additional ventilation, for example opening of a window, or more effective ventilation, for example increasing the level of mechanical ventilation where present.*

## 6 Using your cooktop

### Operating the cooktop

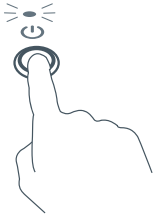

- 1 Press the on/off power button.

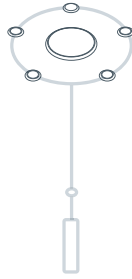

- 2 Press the control dial. A tone will sound.

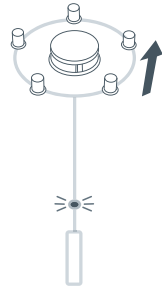

- 3 The dial and the pan supports will rise. The burner-ready light will then glow for four seconds.

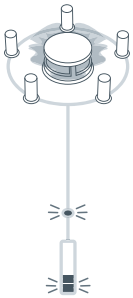

- 4 While the burner-ready light is glowing, turn the dial clockwise to light the gas.

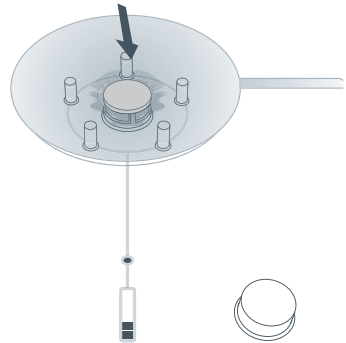

- 5 Place your pan on the pan supports.

Note: if the burner-ready light goes out before you light the gas, press the dial again.



## Operating the cooktop

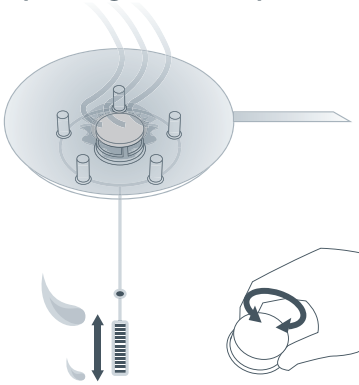

- 6** Turn the dial to accurately adjust the flame.

Note: the flame will not go out if you keep turning the dial down.

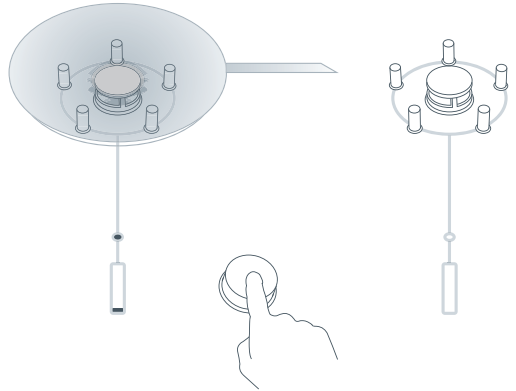

- 7** To stop cooking, press the dial. The gas will be shut off, and the pan supports will stay raised. If they're hot, the hot warning light will glow.

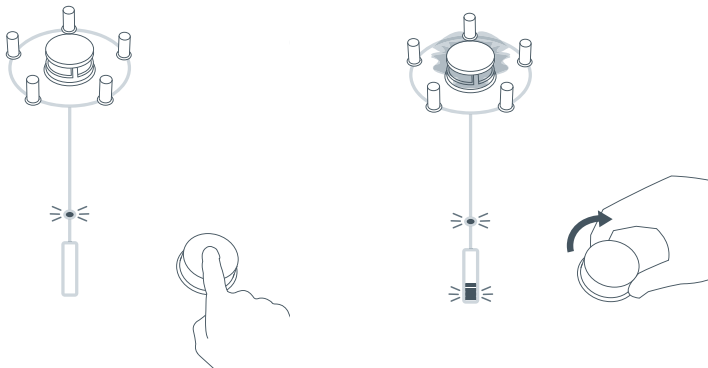

- 8a** To relight the burner when the pan supports are raised:

- Press the dial. The burner-ready light will glow for four seconds.
- While the burner-ready light is glowing, turn the dial clockwise to light the gas.

## 8 Using your cooktop

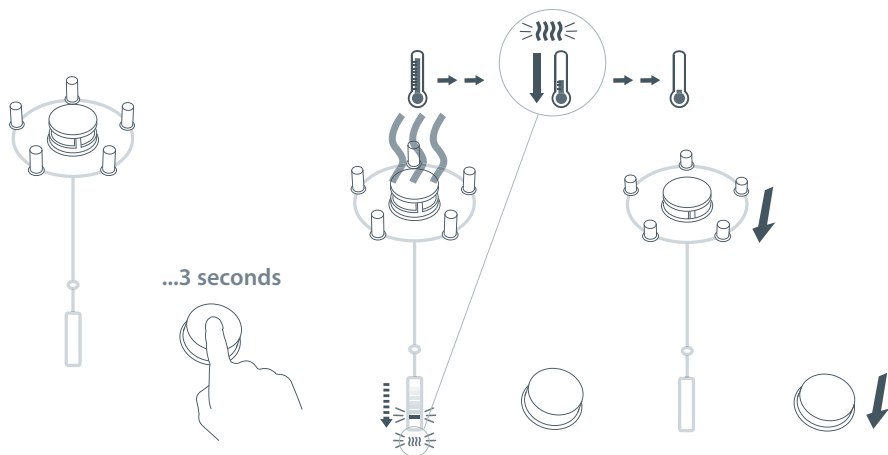

- 8b** To lower the pan supports automatically after you have finished cooking, press and hold the dial for three seconds while the burner is lit. The flame will go out and the pan supports, if cool enough, will lower.

If the supports are hot, the hot warning light will glow and the control display will show a descending sequence of lights until the burner has cooled. This can take between 30 seconds and 30 minutes depending on the flame setting and how long the burner had been in use. Once cool, the pan supports will lower automatically.

To turn the cooktop off, press the on/off power button. Note: if a burner is still cooling, the hot warning light will glow. Once cool, the burner will lower automatically and the cooktop will turn off.

### Keylock

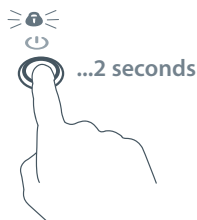

The keylock stops children from turning on the dials. You can only set the keylock when the burners are off. To set the keylock, press and hold the on/off power button for two seconds. A tone will sound and the keylock light will then glow. To turn the keylock light off, press and hold the on/off power button for two seconds, a tone will sound and the keylock will go out.

## ***Important!***

- *Do not use pans with jagged edges or drag pans across the ceramic glass surface as this can scratch the glass.*
- *Do not drag pans backwards and forwards across the pan support pins, burner heads and trim rings eg when placing and removing pans or sauteing food, as this can damage them, especially the coating on the pan support pins.*

## **Cooking tips**

- Match the size of the pan to the burner. You do not need to change burners during cooking because each Aero™ burner goes from very high to very low.
- For best results use high-quality pans with flat, thick bases.
- Only use just enough water to cover the food when boiling and use a lid on the pan to reduce the cooking time and save energy.
- For the small burner, pans should be 10 cm (4") or larger in diameter.
- For the medium burner, pans should be 15 cm (6") or larger in diameter.
- For the wok burner, pans should be 18 cm (7") or larger in diameter. Woks should be no larger than 40 cm (16"). Check that your wok is adequately supported by the wok stand.

## **Using the cooktop's special talents**

The Aero™ burners on your cooktop are versatile, highly responsive and operate over a wide range of settings. Turning the dial gives you accurate and repeatable control of the flame. Once you know what setting is right for your cooking task, you can always use that exact setting for the task.

### **Simmering, keeping food warm, and cooking rice**

- The low turn-down on the smaller Aero™ burners is perfect for delicate tasks, and for keeping hot food warm. Experiment with the low settings until you find the one that suits your pans and the food you are cooking.
- Simmering occurs below boiling point, at around 85 °C, when bubbles are just rising occasionally to the surface of the cooking liquid. It is the key to delicious soups and tender stews because the flavours develop without overcooking the food. You should also cook egg-based and flour-thickened sauces below boiling point.
- Some tasks, including cooking rice by the absorption method, may require a setting higher than the lowest setting to ensure the food is cooked properly in the time recommended.

## Searing steak

To cook juicy flavoursome steaks:

- 1 Stand the meat at room temperature for about 20 minutes before cooking.
- 2 Heat up a heavy-based frying pan.
- 3 Brush both sides of the steak with oil. Drizzle a small amount of oil into the hot pan and then lower the meat onto the hot pan.
- 4 Turn the steak only once during cooking. The exact cooking time will depend on the thickness of the steak and how cooked you want it. Times may vary from about 2 – 8 minutes per side. Press the steak to gauge how cooked it is – the firmer it feels the more 'well done' it will be.
- 5 Leave the steak to rest on a warm plate for a few minutes to allow it to relax and become tender before serving.

## Using a wok

### ***Important!***

- *Use your wok only on the wok burner.*
- *When using a wok, always use the wok stand.*
- *Make sure the wok stand is fitted correctly over the raised pan supports. (see Fig.2)*
- *Do not use a wok larger than 40 cm (16") diameter. Check that your wok is adequately supported by the wok stand.*
- *Make sure the wok does not push any other pans aside. This could make them unstable, or deflect heat onto nearby walls or the benchtop.*

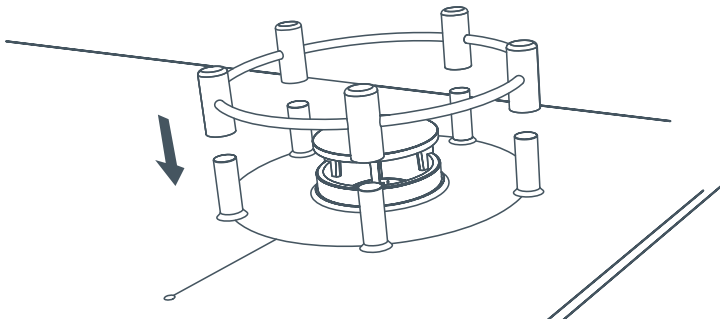

Fig.2 Wok stand is placed onto the raised wok burner pan supports

### **For stir-frying**

- 1 Have all the ingredients and equipment ready. Stir-frying should be quick. If cooking large quantities, cook the food in several smaller batches.
- 2 Preheat the wok for a minute or so with the burner turned up high enough to heat the sides of the wok. (If your wok is small or thin-based, this may not be the highest setting on the burner.)
- 3 Drizzle two tablespoons of oil around the sides of the hot wok, allowing it to run down into the base.
- 4 Cook any meat first, put it aside and keep warm.
- 5 Stir-fry the vegetables. When they are hot but still crisp, turn the burner to low, return the meat to the wok and add your sauce.
- 6 Stir the ingredients gently to make sure they are heated through.
- 7 Serve immediately.

Your cooktop has been designed to combine the easy-care cleaning of ceramic glass with the performance of gas.

### **Important!**

- *Read through the 'Safety and warnings' and 'Care and cleaning' sections carefully before doing any cleaning or maintenance.*
- *To avoid the risk of electrical shock or burners being accidentally turned on during cleaning, make sure you turn the cooktop off before cleaning by pressing the on/off power button.*
- *Remember that the cooktop will need to be turned back on for the pan supports to rise and lower. See the specific cleaning instructions on the pages following.*

To maintain your cooktop in good condition, follow the recommendations in the chart below :

When	What to do	Important!
<b>Immediately</b>	<ul style="list-style-type: none"> <li>■ Remove sugary spillovers or anything that melts onto the ceramic glass. See 'Melts and spills that require immediate attention' for instructions.</li> </ul>	<ul style="list-style-type: none"> <li>■ <i>Take care not to scratch the glass or damage the trim rings or pan support pins.</i></li> <li>■ <i>Take extreme care when working around hot surfaces.</i></li> </ul>
<b>After every use</b>	<ul style="list-style-type: none"> <li>■ Keep the pan supports clean to ensure that they rise and lower properly during use. See 'Cleaning the pan supports (the pan support pins and burner heads)'.</li> <li>■ Lower the cooled, clean pan supports and wipe the cooktop with a damp, soft cloth and mild detergent. See 'Cleaning the ceramic glass' for further instructions and information.</li> </ul>	<ul style="list-style-type: none"> <li>■ <i>Always clean soiled pan supports before lowering them.</i></li> <li>■ <i>Do not let spills and stains become burnt onto the glass or pan supports.</i></li> <li>■ <i>Do not use abrasive sponges, heavy-duty or unsuitable nylon scourers, or corrosive cleaners such as oven sprays and stain removers.</i></li> </ul>
<b>Once every six months</b>	<ul style="list-style-type: none"> <li>■ Check that the airflow through the air filter mesh (on the underside of your cooktop) and the air intake grill (installed in the base of your cabinet) is not blocked or reduced, eg by accumulated dust or other dirt.</li> <li>■ Clean the mesh and grill with a small brush if necessary.</li> </ul>	
<b>Once every year</b>	<ul style="list-style-type: none"> <li>■ Check the gas connection hose for any sign of abrasion, kinking, or any other damage.</li> </ul>	<ul style="list-style-type: none"> <li>■ <i>If you are unsure as to the condition of the gas connection hose, contact your Authorised Service Centre or Customer Care.</i></li> </ul>

### Melts and spills that require immediate attention

Anything that melts onto the ceramic glass surface or food spills with a high sugar content may cause pitting of the ceramic glass surface if left there to cool. Remove these spills immediately with a fish slice, palette knife or cooktop scraper. Take care when working around the hot surfaces and ensure you do not scratch the glass or damage the trim rings or pan support pins. Examples of melts and spills requiring immediate attention include:

- melted plastic wrap
- melted aluminium foil
- sugar, sugary syrups, jams and jellies
- vegetables and vegetable water with a high sugar content eg peas, sweet corn, beetroot.

### Cleaning the ceramic glass

For best results, do not let spills and stains become burnt onto the ceramic glass. Clean the cooktop after every use. Simply lower the cooled pan supports and the control dials and wipe the cooktop with a damp, soft cloth and mild detergent. A microfibre cloth is ideal for this task. Most soiling is very easy to remove because the glass does not get as hot as an electric ceramic glass cooktop. Soften stubborn stains under a soapy cloth.

#### Ceramic cooktop cleaner

Ceramic cooktop cleaner may be used to spot-clean stubborn stains. Follow the instructions on the container. If you must use a razor blade scraper, take care not to damage the trim rings.

### **Important!**

*If cooktop cleaner residue is left on the trim rings, it can dry on and may cause the pan supports, control dials and power button to get stuck. Be careful and wipe around the trim rings and not over them.*

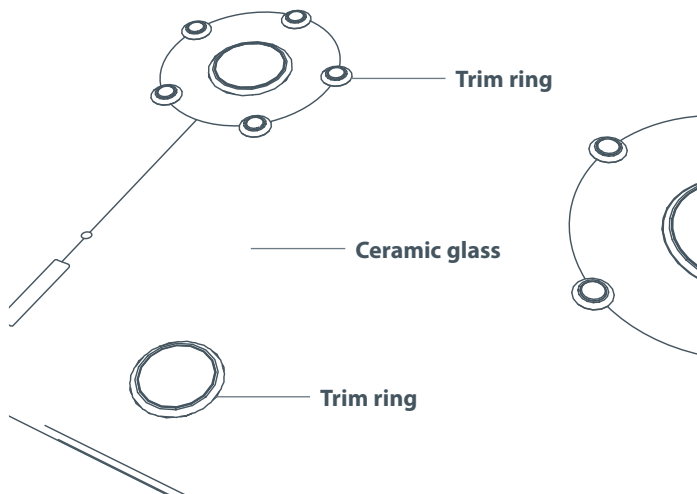

Fig.3 Cleaning the cooking surface

## Cleaning the pan supports (the pan support pins and burner head)

### **Important!**

- *Do not wash pan supports in a dishwasher or use dishwashing machine detergent to clean these parts so as not to remove the easy-clean coating.*
- *After reassembling any burner, always lower the burner before using the cooktop to check it has been reassembled correctly.*

If food spills have burnt onto the pan supports, the supports may not lower when the control dial is pressed and held for two seconds. This is not a fault. You need to remove and clean them.

### To clean the pan support pins

- 1 Press the on/off power button to turn the cooktop on.
- 2 Press the control dial to raise the pan supports.
- 3 Press the on/off power button to turn the cooktop off.
- 4 Gently pull the pan support pins up and out. If food has become burnt onto the pins and the surrounding ceramic glass, it may be necessary to gently twist the pin to remove it.
- 5 Soak the pins in warm water with a little hand dishwashing (or other mild) detergent. The pins have an easy-clean coating. Harsh or abrasive cleaners should not be necessary and may damage the coating.
- 6 Wipe with a soft cloth and dry thoroughly.
- 7 Carefully replace all the pan support pins correctly.
- 8 Press gently to clip into position.

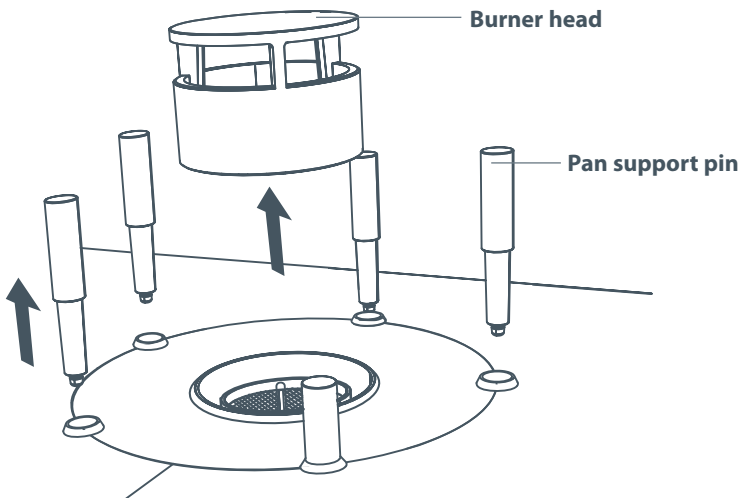

Fig.4 Removing the pan supports



### To clean the burner head

- 1 Lift out the burner head and clean with a cloth or scourer. The burner head gets much hotter than the pan support pins and for this reason it is not finished with an easy-clean coating. If cooking splatter and spills get burnt onto the burner head, scrub with a mildly abrasive cleaner and a soft cloth. Ceramic cooktop cleaner is suitable for this.
- 2 Replace the clean burner head.
- 3 Press the on/off power button to turn the cooktop on.
- 4 Lower the pan supports before using to check they have been reassembled correctly (see Fig. 4).

If spilled or burnt food has stuck the pan supports in the 'down' position, soften the spill with a damp, soapy, soft cloth and remove the food.

### Cleaning the on/off power button and the control dials

Wipe these with a soft cloth and mild detergent. You can remove the control dials by pulling them up and out.

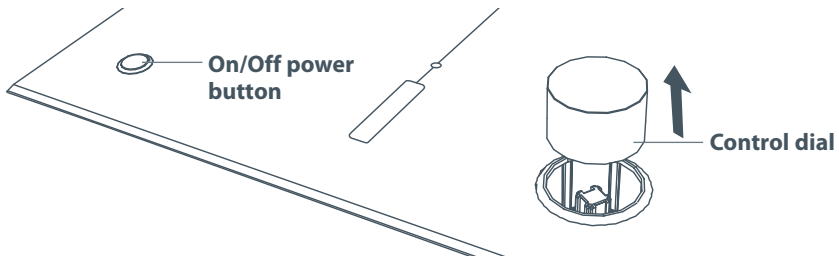

Fig.5 Remove the control dials by pulling them up and out

## 16 Sound preference settings

The cooktop has three pre-set sound preference settings (tones, tone volume, feedback tones).

### Changing the settings

To change the settings, follow these steps.

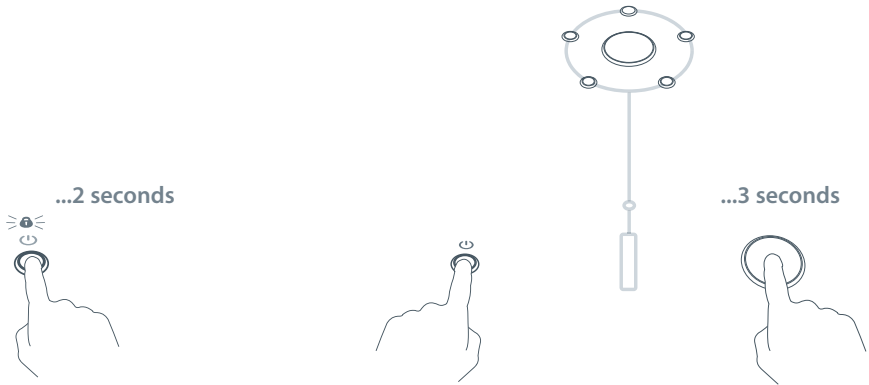

- 1 Hold down the on/off power button for two seconds. This sets the keylock.

- 2 Firmly press both the on/off power button and the nearest burner control dial for three seconds.

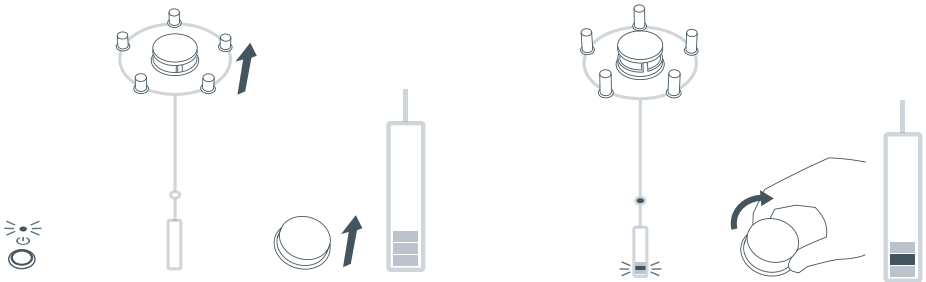





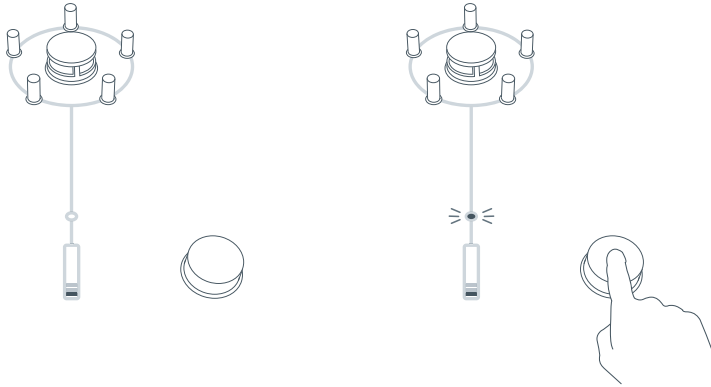









- Once you are in the **Sound preference mode**, the on/off light will flash every second and the burners' pan supports will rise. The keylock light will go out. Turn the dial clockwise to highlight the first setting. The other two lights will be dimmed.

- 3 Each setting has two options (see **table following**). Turn the dial to highlight each setting.



- 4 Touch the dial to change the selected setting. The burner-ready light will go on or off, depending on which option you have chosen.

To revert to the previous option, touch the dial again.

Sound Settings	Default option	Alternative option
<p><b>1 TONES</b></p>  <p><i>(You can turn the cooktop tones on or off)</i></p>	 <p><b>ON</b></p> 	 <p><b>OFF</b></p> 
<p><b>2 TONE VOLUME</b></p>  <p><i>(You can change the cooktop tones' volume from normal to quiet)</i></p>	 <p><b>NORMAL</b></p> 	 <p><b>QUIET</b></p> 
<p><b>3 FEEDBACK TONES</b></p>  <p><i>(You can turn feedback tones for high/low flame settings and burner motion, on or off)</i></p>	 <p><b>ON</b></p> 	 <p><b>OFF</b></p> 

- 5 To store the setting selection(s) and turn the cooktop off, press the on/off power button.



## Troubleshooting chart

Problem	Possible causes	What to do
<b>The pan supports will not rise.</b>	Power is not turned on.	Turn on the cooktop.
<b>The pan supports, on/off power button, or control dials are stuck.</b>	Food has been spilled on these parts.	See 'Care and cleaning'.
<b>A flame is extremely yellow or uneven.</b>	The burner has been incorrectly reassembled after cleaning.	Reassemble the burner correctly (see 'Care and cleaning').
	Food has been spilled on the mesh under the burner head.	Call your Authorised Service Centre or Customer Care.
<b>A burner is not lighting.</b>	You are out of gas.	Check your gas supply.
	Food has been spilled on the igniter.	Call your Authorised Service Centre or Customer Care.
	The burner has been incorrectly reassembled after cleaning.	Reassemble the burner correctly (see 'Care and cleaning').
<b>The flame goes out on the low setting.</b>	You are out of gas.	Check your gas supply.
	Moving air caused by opening/closing cupboard doors is blowing out the flame.	This may occur on a low setting. The burner will relight.
	Draughts are blowing out the flame.	Eliminate the draught. If the problem persists, call your Authorised Service Centre or Customer Care.
<b>The flame setting is too low.</b>	The low flame setting is too low.	Call your Authorised Service Centre or Customer Care.
	An automatic safety mechanism reduces heat to protect the cooktop and its surroundings from overheating.	This is normal and requires no action. Once the burners have cooled to a temperature threshold, they will automatically power back to the displayed setting. To minimise the need for this mechanism, use the wok burner for prolonged high-heat cooking, and ensure that the pot is not larger than 40 cm across its base.

## Troubleshooting chart

Problem	Possible causes	What to do
<b>Pan supports rise or lower slowly and noisily.</b>	Food has been spilled on these parts.	Clean the pan supports (see 'Care and cleaning'.)
<b>There is an unpleasant (gas) smell.</b>	The cooktop is not functioning correctly or gas could be leaking.	Shut off the gas and electricity supply, ventilate the room and call your Authorised Service Centre or Customer Care.
<b>There is an electricity failure.</b>		The cooktop cannot be used without an electricity supply. If the electricity has failed while the cooktop was on, the gas supply will automatically shut off. The cooktop will return to the 'off' state when the electricity is restored and will be ready to use.
<b>The cooktop shuts down suddenly. (Some alert codes may not have had time to display.)</b>	The cooktop has shut itself down to prevent damage.	Call your Authorised Service Centre or Customer Care. For more information, and if alert codes were displayed, see 'Alert codes'.
	There has been an electricity failure.	See above problem.
<b>The cooktop is beeping and flashing.</b>	It is asking you to do something.	See the 'Alert codes'. If the problem fails to clear after repeated attempts, call your Authorised Service Centre or Customer Care.
<b>The on/off light is flashing three times repeatedly and the cooktop appears useable but there is no flame.</b>	The cooktop is in 'Showroom' mode.	Turn the power to the cooktop off at the wall. Wait a few seconds and then turn the power back on again.

Your cooktop can self-diagnose and then communicate this information to you.

*If there is a problem, the cooktop will:*



- shut one or all burners off
- beep every three seconds
- flash one or more lights
- display an alert code on the control display(s). If only one burner has a problem, then its control display will show the alert code. If the whole cooktop has a problem, then all the control displays will show a code (in most cases).

## To clear the alert code and fix the problem

- 1 Make a note of which burner(s) display an alert code and the number of bars displayed. You will need this information.
- 2 Turn the power to the cooktop off at the wall.
- 3 Wait 30 seconds, then turn the cooktop back on again.
- 4 Check the chart following to see if you can fix the problem yourself.
- 5a If you can fix the problem and the alert code does not reappear, you can keep using your cooktop.  
**OR**
- 5b If you can't fix the problem yourself or the problem persists, turn the cooktop off and call your Authorised Service Centre or Customer Care with the alert code information.

Note: if a burner happens to be hot, the cooktop will wait for the burner to cool down before shutting down.

## Individual burner codes

Alert code	Possible causes	What to do
 <b>2 bars</b>	<p>The pan is too heavy for the pan supports to lift.</p>	<p>Remove the pan, let the pan supports rise up, and then place the pan back on the pan supports.</p>
	<p>The pan support pins are stuck in the down position because of spilled food.</p>	<p>Try to remove the food with a damp, soapy, soft cloth. If you cannot remove the food, then call your Authorised Service Centre or Customer Care.</p>
 <b>3 bars</b>	<p>The pan supports are stuck in the up position.</p>	<p>Clean the pan supports as described in the 'Care and cleaning' section. If the pan supports will not lower after cleaning, call your Authorised Service Centre or Customer Care.</p>
	<p>The burner has extremely overheated. (This only happens after very long use at maximum temperatures.)</p>	<p>Wait for the cooktop to cool down. Once the code has disappeared, you can use your burner again.</p>
 <b>4 bars</b>	<p>No gas.</p>	<p>Check your gas supply, then turn the cooktop off and on again. If you have checked your gas supply and the cooktop displays this code again, call your Authorised Service Centre.</p>
	<p>Draughts from an open window or other ventilation are causing the burner to go out on low settings.</p>	<p>The cooktop continuously monitors each burner to make sure the flame does not go out, and relights it if it does. If the system cannot relight a burner, it shuts off the gas, and displays this code. Call your Authorised Service Centre or Customer Care.</p>
	<p>Food on the igniter.</p>	<p>Call your Authorised Service Centre or Customer Care.</p>

Entire Cooktop codes

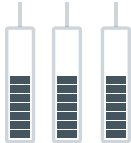
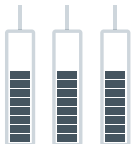
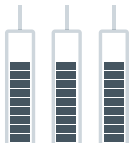
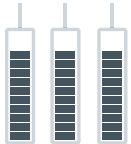
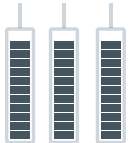
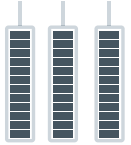
Alert code	Possible causes	What to do
 <p>7 bars</p>	<p>There is not enough air getting to the burners.</p>	<p>Check that</p> <ul style="list-style-type: none"> <li>the underside of the cooktop has direct unrestricted ventilation to the room where the cooktop is installed</li> <li>nothing is obstructing the air filter mesh on the underside of the cooktop</li> <li>the airway to the cooktop is not affected by air movement from outside the cabinet (draughts from other rooms, through walls, or outside the building).</li> </ul>
 <p>8 bars</p>	<p>Flame has been detected on a burner that is not going.</p>	<p>Shut the power to the cooktop off at the wall, then shut off the gas supply to the cooktop and call your Authorised Service Centre or Customer Care.</p>
 <p>9 bars</p>	<p>The on/off power button is stuck.</p>	<p>Call your Authorised Service Centre or Customer Care.</p>
 <p>10 bars</p>	<p>There is a pan support malfunction.</p>	<p>Call your Authorised Service Centre or Customer Care.</p>
 <p>11 bars</p>	<p>There is a gas valve control malfunction.</p>	<p>Call your Authorised Service Centre or Customer Care.</p>
 <p>12 bars</p>	<p>Electronics malfunction for the whole cooktop.</p>	<p>Call your Authorised Service Centre or Customer Care.</p>



## Before you call for service or assistance ...

Check the things you can do yourself. Refer to the installation instructions and your user guide and check that:

- 1 your product is correctly installed
- 2 you are familiar with its normal operation.

If after checking these points you still need assistance or parts, please refer to the Service & Warranty book for warranty details and your nearest Authorised Service Centre, Customer Care, or contact us through our local website listed on the back cover.

## Product details

Fisher & Paykel Ltd

**Model** ..... **Serial No.** .....

**Date of Purchase** ..... **Purchaser** .....

**Dealer** ..... **Suburb** .....

**Town** ..... **Country** .....





[www.fisherpaykel.co.nz](http://www.fisherpaykel.co.nz)  
[www.fisherpaykel.com.au](http://www.fisherpaykel.com.au)

***Fisher & Paykel***

Copyright © Fisher & Paykel 2011. All rights reserved.

The product specifications in this booklet apply to the specific products and models described at the date of issue. Under our policy of continuous product improvement, these specifications may change at any time. You should therefore check with your Dealer to ensure this booklet correctly describes the product currently available.

## Free Manuals Download Website

<http://myh66.com>

<http://usermanuals.us>

<http://www.somanuals.com>

<http://www.4manuals.cc>

<http://www.manual-lib.com>

<http://www.404manual.com>

<http://www.luxmanual.com>

<http://aubethermostatmanual.com>

Golf course search by state

<http://golfingnear.com>

Email search by domain

<http://emailbydomain.com>

Auto manuals search

<http://auto.somanuals.com>

TV manuals search

<http://tv.somanuals.com>