

*Fisher & Paykel*

DishDrawer®  
DD607 & DD247

**Service Manual**

**NZ AU GB IE US CA**

# FEATURED PRODUCT & CONTACT ADDRESSES

**Brand:** Fisher & Paykel

Standard Double Models	Description	Product Codes - Markets
DD24DCW7	Double, Classic White	88636-US / CA
DD24DCX7	Double, Classic Brushed Stainless Steel	88637-US / CA
DD24DI7	Double , Integrated	88639-US / CA
DD24DCB7	Double, Classic Black	88641-US / CA
DD24DDFX7	Double, Designer, Brushed Stainless	88642-US / CA
DD60DCHX7	Double Classic Brushed Stainless, Water Softener	89383-GB 89394-EU 89403-DK 85070-TW
DD60DHI7	Double, Integrated, Water Softener	89384-GB 89395-EU 89404-DK 85071-TW
DD60DCHB7	Double, Classic Black, Water Softener	89385-GB
DD60DDFHX7	Double, Designer, Brushed Stainless, Water Softener	89386-GB 89396-EU 89405-DK
DD60DCHW7	Double, Classic White, Water Softener	89382-GB 89402-DK 85069-TW
DD60DI7	Double Integrated	80769-AA
DD60DCM7	Double, Classic Iridium Stainess	80770-AA
DD60DCW7	Double, Classic White	80767-AA
DD60DCX7	Double, Classic Brushed Stainless	80768-AA
DD60DDFM7	Double, Designer, Iridium	80771-AA
DD60DDFX7	Double, Designer, Brushed Stainless	80772-AA

**Fisher & Paykel Appliances Ltd**

PO Box 58-732, Botany  
78 Springs Rd, East Tamaki  
Manukau 2163  
New Zealand

tel: (09) 2730660  
fax: (09) 2730580  
email: customer.care@fp.co.nz

**Fisher & Paykel Customer Services Pty Ltd**

PO Box 798, Cleveland, QLD 4163  
A.C.N. 003 3335 171  
19 Enterprise Street Cleveland, QLD 4163  
Australia

tel: (07) 3826 9100  
fax: (07) 3826 9164  
email: customer.care@fp.com.au

**Fisher & Paykel Appliances Ltd**

Singapore  
150 Ubi Avenue 4  
Sunlight building #02-00  
Singapore 408825

tel: 6547 0100  
service tel: 6741 0777  
fax: 6547 0123

**Fisher & Paykel Appliances Ltd U.K**

Maidstone Road  
Kingston  
Milton Keynes  
Buckinghamshire  
England, MK10 0BD

tel: 0845 066 2200  
fax: 0845 331 2360  
email: customer.care@fisherpaykel.co.uk

**Fisher & Paykel Appliances**

Unit D2  
North Dublin Corporate Park  
Swords  
Co Dublin  
Ireland

tel: 1800 625 174  
fax: 1800 635 012  
email: customer.care@fisherpaykel.ie

**Fisher & Paykel Appliances Inc.**

5900 Skylab Rd,  
Huntington Beach  
California, CA92647  
USA

tel: 888 936 7872  
email: customer.care@fisherpaykel.com

<b>Standard Single Models</b>	<b>Description</b>	<b>Product Codes - Markets</b>
DD24SCW7	Single, Classic White	88629-US / CA
DD24SCX7	Single, Classic Brushed Stainless Steel	88630-US / CA
DD24SI7	Single , Integrated	88632-US / CA
DD24SCB7	Single, Classic Black	88634-US / CA
DD24SDFX7	Single, Designer, Brushed Stainless	88635-US / CA
DD60SCHX7	Single, Classic Brushed stainless, Water Softener	89388-GB 89397-EU 89407-DK 85073-TW
DD60SHI7	Single, Integrated, Water Softener	89389-GB 89398-EU 89408-DK 85074-TW
DD60SCHB7	Single, Classic Black, Water Softener	89390-GB
DD60SDFHX7	Single, Designer, Brushed Stainless, Water Softener	89391-GB 89366-EU 89409-DK
DD60SCHW7	Single, Classic White, Water Softener	89387-GB 89406-DK 85072-TW
DD60SI7	Single, Integrated	80775-AA
DD60SCW7	Single, Classic White	80773-AA
DD60SCX7	Single, Classic Brushed Stainless	80774-AA
DD60SHLI7	Single, Integrated, Water Softener, Long Door	89411-DK
DD60SDFX7	Single, Designer, Brushed Stainless	80776-AA

<b>Tall Tub Double Models</b>	<b>Description</b>	<b>Product Codes - Markets</b>
DD24DDFTX7	Double Designer, Brushed Stainless, Tall Tub	88620-US / CA
DD24DTI7	Double Integrated, Tall Tub	88622-US / CA
DD24DCTX7	Double, Classic, Brushed Stainless, Tall Tub	88626-US / CA
DD24DCHTX7	Double, Classic, Brushed Stainless, Water Softener	88638-US / CA
DD24DHTI7	Double, Integrated, Water Softener	88640-US / CA
DD24DCTW7	Double, Tall Tub, Classic White	88628-US / CA
DD24DCTB7	Double, Tall Tub, Classic Black	88624-US / CA

<b>Tall Tub Single Models</b>	<b>Description</b>	<b>Product Codes - Markets</b>
DD24SDFTX7	Single, Designer, Tall Tub, Brushed Stainless	88621-US / CA
DD24STI7	Single, Integrated, Tall Tub	88623-US / CA
DD24SCHTX7	Single, Classic, Tall Tub, Brushed Stainless Steel	88631-US / CA
DD24SCTW7	Single, Tall Tub, Classic White	88643-US / CA
DD24SCTB7	Single, Tall Tub, Classic Black	88625-US / CA
DD24SHTI7	Single, Integrated, Water Softener, Tall Tub	88633-US / CA
DD24SCTX7	Single, Classic, Tall Tub, Brushed Stainless,	88627-US / CA
DD60SHTI7	Single, Integrated, Tall Tub, Water Softener	89381-GB 89393-EU
DD60SDFHTX7	Single, Designer, Brushed Stainless, Tall Tub, Water Softener	89380-GB 89392-EU
DD60SDFTX7	Single, Designer, Brushed Stainless, Tall Tub	80761-AA
DD60SDFTM7	Single, Designer, Iridium Stainless, Tall Tub	80763-AA
DD60STI7	Single, Integrated, Tall Tub	80762-AA
DD60SCTW7	Single, Tall Tub, Classic White	80764-AA
DD60SCTX7	Single, Tall Tub, Classic, Stainless Steel	80765-AA
DD60SCTM7	Single, Tall Tub, Classic, Iridium Stainless	80766-AA
DD60SDFHTX7	Single, Designer, Water Softener, Tall Tub	89400-DK
DD60SHTI7	Single, Integrated, Water Softener, Tall Tub	89401-DK
DD60SHTLI7	Single, Integrated, Water Softener, Tall Tub, Long Door	89410-DK



# CONTENTS

<b>1</b>	<b>SERVICE REQUIREMENTS</b>	<b>7</b>
1.1	Health & Safety	7
1.2	Specialised Tools	8
<b>2</b>	<b>DIMENSIONS &amp; SPECIFICATIONS</b>	<b>9</b>
<b>3</b>	<b>TECHNICAL OVERVIEW</b>	<b>14</b>
3.1	Chassis	14
3.2	Drawer Fronts	14
3.3	Electronics	14
3.4	Motor	16
3.5	Lid System	18
3.6	Tub	18
3.7	Filling	18
3.8	Heating	20
3.9	Motor and Heater Plate Locknuts	21
3.10	Drain Cycle	21
3.11	Filter Plate	22
3.12	Drying Cycle	23
3.13	Water Softener (if fitted)	24
<b>4</b>	<b>OPTION ADJUSTMENT MODE</b>	<b>25</b>
4.1	How to Change the Setup Options (Classic, Designer & Integrated models)	25
4.2	Option Adjustment Quick Reference Charts	27
<b>5</b>	<b>DIAGNOSTICS</b>	<b>30</b>
5.1	DishDrawer Diagnostics	30
5.2	DishDrawer Diagnostics Wireless Badge Models	34
<b>6</b>	<b>FAULT CODES AND POOR PERFORMANCE</b>	<b>36</b>
6.1	Fault Code Description Chart	37
6.1.1	Sub Code Faults	38
6.2	Poor Dry Performance	40
6.3	Poor Wash Performance	41
<b>7</b>	<b>FAULT FINDING PROCEDURE</b>	<b>44</b>
7.2	Completing a Service	54

<b>8</b>	<b>WIRING DIAGRAMS</b>	<b>55</b>
8.2	Wiring Diagram	56
<b>9</b>	<b>SERVICE PROCEDURES</b>	<b>57</b>
9.1	Component Testing	57
9.2	Drawer Front	58
9.3	Handle and LCD Display	58
9.4	Toe Kick Removal	59
9.5	Lower Tub Cowling	59
9.6	Tub Removal	59
9.7	Drying Duct - Top Tub Only	60
9.8	Drying Fan and Flap Valve	60
9.9	Detergent Dispenser	61
9.10	Electronic Controller	61
9.11	Filter Plate	62
9.12	Motor Rotor	62
9.13	Water Softener (if fitted)	63
9.14	Strainer (if fitted)	63
9.15	Wiring Cover	64
9.16	Tub Disconnection	64
9.17	Hall Sensor	65
9.18	Heater Plate and Motor Assembly	65
9.19	Lid	66
9.20	Yoke	68
9.21	Lid Actuator	68
9.22	Slide Rail Replacement.	69
9.23	Mains Filter Cover and PCB Mains Filter	69
9.24	Water Inlet Valve	70
9.25	Fill Hose, Drain Hose, Wiring Harness Replacement	70
9.26	Link Support Wire Position	70
9.27	Front Chassis Trim Replacement	71
9.28	Single Integrated Vent Duct Removal	71
9.29	Internal Duct and Elbow Removal	72
9.30	Wireless Receiver & Badge Remote	73
<b>10</b>	<b>NOTES</b>	<b>76</b>

## 1.1 Health & Safety

**Note:** When servicing the DishDrawer™, Health and Safety issues must be considered at all times. Specific safety issues are listed below with their appropriate icon. These are illustrated throughout the service information to remind service people of the Health and Safety issues.

### 1.1.1 Electrical Safety



Ensure the mains power has been disconnected before servicing the DishDrawer™. If the mains supply is required to be on to service the DishDrawer™, make sure it is turned off when removing any electrical component or connection to avoid electrical shock.

### 1.1.2 Electrostatic Discharge



An anti-static strap is to be used as electrical static discharge (ESD) protection when servicing electronic components.

### 1.1.3 Good Working Practices



Ensure the work area is in a tidy and orderly condition at all times so as not to cause a hazard while service work is being completed. Always clean and tidy the DishDrawer™ and work area after service is completed.

### 1.1.4 Isolate Water Supply



Turn off the water connection tap before servicing.

### 1.1.5 Water Leak Check



Check for water leaks as part of the testing after the service has been completed.

### 1.1.6 Insulation Test



Megger test to check insulation.

Warning: Short together the phase and neutral pins on the plug so as not to damage any electronic circuitry.

### 1.1.7 Solvent and Excessive Heat Damage



Solvents and excessive heat can damage plastic surfaces.

### 1.1.8 Sheet Metal Edges



When working around cut sheet metal edges use appropriate gloves or protection to eliminate the chance of receiving a laceration.

### 1.1.9 Diagnostics



While in diagnostics some safety devices are bypassed. Ensure you do not run components unattended. They may overheat, flood, burn out or cause water damage.

## 1.2 Specialised Tools

For servicing this product, specialised tools are required.

### 1.2.1 *Static Strap*

To be used as ESD (electrostatic discharge) protection when replacing or handling electronic components.

**Product Dimensions**

Standard Product	Product Size (mm)	Product Size (inches)	Minimum Cavity Size (mm)	Minimum Cavity Size (inches)
Height (Double)	820 -880mm	34 5/8"	820mm	32 5/16"
Height Single	410mm	16 1/8"	412mm	16 1/4"
Width	599mm	23 9/16"	600mm	23 5/8"
Depth (classic)	582mm	22 15/16"	560mm	22 1/16"
Depth (FD & IN)	571mm	22 1/2"	560mm	22 1/16"

Tall Tub Product	Product Size (mm)	Product Size (inches)	Minimum Cavity Size (mm)	Minimum Cavity Size (inches)
Height (Double)	864-924mm	34-36 3/8"	864mm	34"
Height Single ( classic)	454mm	17 7/8"	456mm	18"
Height Single (FD & IN)	454-478mm	17 7/8" - 18 13/16"	480mm	18 7/8"
Width	599mm	23 9/16"	600mm	23 5/8"
Depth (Classic)	582mm	22 15/16"	560mm	22 1/16"
Depth (FD & IN)	571mm	22 1/2"	560mm	22 1/16"

**NOTE:** For more detailed installation measurements refer to the installation guides on CBW.  
[www.cbw.fp.co.nz](http://www.cbw.fp.co.nz)

**Electrical Specifications**

Market	Voltage	Frequency	Current Double/Single
AA / GB / EU / DK	230/240 V	50/60 Hz	10 / 5 A
USA / CA / TW	110 /120 V	60 Hz	10.6 / 5.3 A

## Component Specifications

Component		Specification
Controller	NZ, AU, GB, EU, DK US, CA, TW	230V 120V
Water Inlet Valve	all markets	24V DC 65+/- 10 Ohms per coil 2.5litres/min (0.65 US gal/min)
Dispenser Coils	all markets	24V DC per coil 65+/- 10 Ohms per coil
Rinse Aid Tank	all markets	50mls (approx. 25 washes) 3.05 cubic inches
PCB Mains Filter (2 Types - Single / Double)	NZ, AU, GB, EU, DK US, CA, TW	230V AC 110V AC
Motor Drain Speed Wash Speed	Pump out rate 5 litres / min.	80V DC 3 Phase Brushless 5000 RPM 2200 - 2800 RPM
Stator		8.0 Ohms (per winding), 16 ohms phase to phase from the controller connector
Heater plate 230V Wattage Water Heater Track Power Supply Resistor	NZ, AU, GB, EU, DK	230V AC 1045W 50 Ohms +/- 4 Ohms 98 Ohms +/- 7 Ohms
Temperature Sensor	Located on the heater plate	12000 Ohms @ 20 °C 8300 Ohms @ 30 °C 3000 Ohms @ 60 °C
Heater Plate 110V Wattage Water Heater Track Power Supply Resistor	US, CA, TW	120V AC 650W 24 Ohms +/- 3 Ohms 24 Ohms +/- 3 Ohms
Temperature Sensor	Located on the heater plate	12000 Ohms @ 68 °F 8300 Ohms @ 86 °F 3000 Ohms @ 140 °F
Fusible link	Located on the heater plate	268 – 302 °C (514 – 576 °F)
Water Inlet hose	Pressure Rating Length from chassis edge (viewed from the front)	1MPa (145psi) 1650mm (64 ¾") left hand side 1250mm (49") Right hand side
Water Pressure	Non water softener models  Water softener models	1MPa (145 psi) max, 0.03 MPa (4.3psi) min  1MPa (145psi) max, 0.1MPa (14.5psi) min
Drain Hose		2000 mm (78 ½") from left hand side 1800mm (70 ½") from right hand side.
Power Cord	NZ, AU, GB, EU, DK length from chassis exit when product viewed from the front US, CA, TW	1650mm  29 ½" LH side, 27 ½" RH side

Component		Specification
Drying Fan		24V brushless DC motor 0.27A only replace if open or short circuit
Diverter valve water softener		24V DC Coil 65 +/- 10 Ohms Coil
Brine pump assembly		24V DC Coil 65 +/- 10 Ohms Coil
Water softener		500 grams Salt Capacity approx. 14 regenerations 290+/- 10ml Resin
Lid actuator		24V DC Only replace if open or short circuit.
Hall sensor		5 V DC
LCD	5 volt rail between pins 2&5	LCD has a back light

## Performance

### NZ/AU

Based on 7 wash loads per week, using normal eco program

	Per Tub	Star Rating
Energy	134 kWh	3.5
Water	6.7L	4.5

### GB, EU

Per Tub	Energy	Wash	Dry
	A	A	A
	0.64		

### US, CA, TW

Based on 4 wash loads per week

Product	Energy
Single	141 kWh
Single Integrated	155 kWh
Double	276 kWh

## Wash Profiles (Non Vented)

NZ, AU

Incoming @ 20°C

Wash Cycle		D	F	Wash		D	F	Post Rinse 1		D	F	Post Rinse 2		D	F	Final Rinse		D	Dry	Time (min)	Total Water	Fan run on (min)	
Heavy @2800rpm	Time (min)	1	1	46	2	1	10	2	1	10	2	1	15	2	30	124	10.4	120					
	Temp (°C)			70°C									65°C										
	Fill (L)			2.7			2.5			2.5			2.7										
Heavy Eco @2500-2600rpm	Time (min)	1	1	41	2	1	6	2	1	6	2	1	24	2	30	120	10.6	120					
	Temp (°C)			65°C									55°C										
	Fill (L)			2.7			2.5			2.5			2.7										
Normal @2400-2600rpm	Time (min)	1	1	55	2	1	10	2				1	33	2	20	128	7.6	120					
	Temp (°C)			60°C									60°C										
	Fill (L)			2.3			2.8						2.5										
Normal Eco @2200rpm	Time (min)		1	40	2	1	10	2				1	35	2	55	149	6.6	30					
	Temp (°C)			39°C									40°C										
	Fill (L)			2.3			2.1						2.2										
Delicate @2300rpm	Time (min)	1	1	26	2	1	4	2	1	4	2	1	15	2	30	92	10	120					
	Temp (°C)			50°C									60°C										
	Fill (L)			2.5			2.5			2.5			2.5										
Delicate Eco @2300rpm	Time (min)	1	1	21	2	1	3	2	1	3	2	1	10	2	30	80	10	120					
	Temp (°C)			45°C									50°C										
	Fill (L)			2.5			2.5			2.5			2.5										
Fast @2500rpm	Time (min)	1	1	22	2	1	2	2				1	10	2	5	49	7.5	120					
	Temp (°C)			55°C									55°C										
	Fill (L)			2.5			2.5						2.5										
Fast Eco @2700rpm	Time (min)	1	1	12	2	1	2	2				1	7	2	2	33	7.5	30					
	Temp (°C)			45°C									45°C										
	Fill (L)			2.5			2.5						2.5										
Rinse @2300rpm	Time (min)	1	1	7	2											11	2.5						
	Temp (°C)																						
	Fill (L)			2.5																			

GB, EU

Incoming Water 15°C

Wash Cycle		D	F	Prewash	D	F	Main Wash	D	F	Post Rinse 1	D	F	Post Rinse 2	D	F	Final Rinse	D	Dry	Time (min)	Fills (L)	Fan run on (min)	
Heavy 2800rpm	Time (min)				1	1	57	2	1	4	2	1	4	2	1	18	2	30	126	12.8	120	
	Temp (°C)						70°C									65°C						
	Fill (L)						3.2			3.2			3.2			3.2						
Heavy Eco 2800rpm	Time (min)				1	1	41	2	1	4	2	1	4	2	1	14	2	45	121	10.7	120	
	Temp (°C)						60°C									55°C						
	Fill (L)						3.2			2.5			2.5			2.5						
Normal 2650rpm	Time (min)				1	1	32	2	1	3	2	1	3	2	1	19	2	25	95	12.8	120	
	Temp (°C)						65°C									65°C						
	Fill (L)						3.2			3.2			3.2			3.2						
Normal Eco 2400rpm	Time (min)	1	1	12			43	2	1	30	2				1	24	2	40	159	8*	30	
	Temp (°C)			42°C			50°C									60°C						
	Fill (L)			2.5			Fill valve 12s*			2.5						2.5						
Delicate 2300rpm	Time (min)				1	1	26	2	1	4	2	1	4	2	1	15	2	30	92	10	120	
	Temp (°C)						50°C									60°C						
	Fill (L)						2.5			2.5			2.5			2.5						
Delicate Eco 2300rpm	Time (min)				1	1	24	2	1	7	2	1	3	2	1	10	2	30	87	10	120	
	Temp (°C)						45°C									50°C						
	Fill (L)						2.5			2.5			2.5			2.5						
Fast 2500rpm	Time (min)				1	1	26	2	1	2	2				1	10	2	5	53	7.5	120	
	Temp (°C)						55°C									50°C						
	Fill (L)						2.5			2.5						2.5						
Fast Eco 2500rpm	Time (min)				1	1	16	2	1	2	2				1	10	2	1	39	7.5	30	
	Temp (°C)						45°C									45°C						
	Fill (L)						2.5			2.5						2.5						
Rinse 2300rpm	Time (min)	1	1	7	2														11	3.2		
	Temp (°C)																					
	Fill (L)			3.2																		

US, CA

Incoming @ 120°F (49°C)

Wash Cycle		D	F	Main Wash	D	F	Post Rinse 1	D	F	Post Rinse 2	D	F	Post Rinse 3	D	F	Final Rinse	D	Dry	Time (min)	Water (L)	Fan Run on	
Heavy @2800rpm	Time (min)	1	1	36	2	1	21	2	1	3	2	1	3	2	1	20	2	28	127	13.9	120	
	Temp			65°C/149°F						2.5			2.5			70°C/158°F						
	Fill (L)			3.2			3.2			2.5			2.5			2.5						
Heavy Eco @2800rpm	Time (min)	1	1	31	2	1	14	2	1	3	2	1	3	2	1	15	2	25	107	12.5	120	
	Temp			65°C/149°F						2.5			2.5			65°C/149°F						
	Fill (L)			2.5			2.5			2.5			2.5			2.5						
Normal @2800rpm	Time (min)	1	1	20	2	1	40	2	1	10	2				1	20	2	25	128	12	120	
	Temp			50°C/122°F			55°C/131°F									55°C/131°F						
	Fill (L)			3.0			3.0			3.0						3.0						
Normal Eco @2400rpm	Time (min)	1	1	38	2	1	10	2							1	20	2	22	100	7.6	30	
	Temp			48°C/118°F												52°C/125°F						
	Fill (L)			2.6			2.5									2.5						
Delicate @2300rpm	Time (min)	1	1	21	2	1	5	2	1	3	2				1	15	2	25	82	10	120	
	Temp			50°C/122°F												55°C/131°F						
	Fill (L)			2.5			2.5			2.5						2.5						
Delicate Eco @2300rpm	Time (min)	1	1	19	2	1	5	2	1	3	2				1	12	2	16	68	10	120	
	Temp			45°C/113°F												50°C/122°F						
	Fill (L)			2.5			2.5			2.5						2.5						
Fast @2500rpm	Time (min)	1	1	26	2	1	2	2							1	10	2	5	53	7.5	120	
	Temp			55°C/131°F												50°C/122°F						
	Fill (L)			2.5			2.5									2.5						
Fast Eco @2500rpm	Time (min)	1	1	11	2	1	3	2							1	9	2	2	35	7.5	30	
	Temp			45°C/113°F												45°C/113°F						
	Fill (L)			2.5	</																	



## Wash Profiles (Vented Single Integrated)

### DD60 Australia/New Zealand Wash Profiles

Wash Profile 524019 EE DD NZ 21\_0\_010 (Vented)

Incoming @ 20°C

Wash Cycle		D	F	Wash		D	F	Post Rinse 1		D	F	Post Rinse 2		D	F	Final Rinse		D	P	D	Dry	Time (min)	Total Water	Fan run on (min)
Heavy @2800rpm	Time (min) Temp (°C) Fill (L)	1	1	46 70°C 2.7	2	1	10 2.5	2	1	10 2.5	2	1	15 57°C 2.7	2	35	1	40	170	10.4	120				
Heavy Eco @2500-2600rpm	Time (min) Temp (°C) Fill (L)	1	1	41 65°C 2.7	2	1	6 2.7	2	1	6 2.5	2	1	24 55°C 2.7	2	35	1	40	166	10.6	120				
Normal @2400-2600rpm	Time (min) Temp (°C) Fill (L)	1	1	55 60°C 2.3	2	1	10 2.8	2	1	33 57°C 2.5	2	35	1	30	174	7.6	120							
Normal Eco @2200rpm	Time (min) Temp (°C) Fill (L)	1	1	40 39°C 2.3	2	1	10 2.1	2	1	35 40°C 2.2	2	24	1	70	189	6.6	30							
Delicate @2300rpm	Time (min) Temp (°C) Fill (L)	1	1	26 50°C 2.5	2	1	4 2.5	2	1	4 2.5	2	1	15 57°C 2.5	2	35	1	30	128	10	120				
Delicate Eco @2300rpm	Time (min) Temp (°C) Fill (L)	1	1	21 45°C 2.5	2	1	3 2.5	2	1	3 2.5	2	1	10 50°C 2.5	2	30	1	30	111	10	120				
Fast @2500rpm	Time (min) Temp (°C) Fill (L)	1	1	22 55°C 2.5	2	1	2 2.5	2	1	10 55°C 2.5	2	35	1	3	83	7.5	120							
Fast Eco @2700rpm	Time (min) Temp (°C) Fill (L)	1	1	12 45°C 2.5	2	1	2 2.5	2	1	7 45°C 2.5	2	25	1	3	60	7.5	120							
Rinse @2300rpm	Time (min) Temp (°C) Fill (L)	1	1	7 2.5	2	11	2.5																	

### DD60 United States/Canada Wash Profiles

Wash Profile 524020 EE DD US 22\_0\_010 (Vented)

Incoming @ 49°C

Wash Cycle		D	F	Main Wash		D	F	Post Rinse 1		D	F	Post Rinse 2		D	F	Post Rinse 3		D	F	Final Rinse		D	P	D	Dry	Time (min)	Water (L)	Fan Run on
Heavy @2800rpm	Time (min) Temp Fill (L)	1	1	36 65°C/149°F 2.5	2	1	21 3.2	2	1	3 2.5	2	1	3 2.5	2	1	20 57°C/134°F 2.5	2	35	1	28	163	13.2	120					
Heavy Eco @2800rpm	Time (min) Temp Fill (L)	1	1	31 65°C/149°F 2.5	2	1	14 2.5	2	1	3 2.5	2	1	3 2.5	2	1	15 57°C/134°F 2.5	2	35	1	40	158	12.5	120					
Normal @2800rpm	Time (min) Temp Fill (L)	1	1	20 50°C/122°F 3.0	2	1	40 55°C/131°F 3.0	2	1	10 3.0	2	1	20 55°C/131°F 3.0	2	35	1	25	164	12	120								
Normal Eco @2400rpm	Time (min) Temp Fill (L)	1	1	38 48°C/118°F 2.6	2	1	10 2.5	2	1	20 52°C/125°F 2.5	2	32	1	22	133	7.6	120											
Delicate @2300rpm	Time (min) Temp Fill (L)	1	1	21 50°C/122°F 2.5	2	1	5 2.5	2	1	3 2.5	2	1	15 55°C/131°F 2.5	2	35	1	25	118	10	120								
Delicate Eco @2300rpm	Time (min) Temp Fill (L)	1	1	19 45°C/113°F 2.5	2	1	5 2.5	2	1	3 2.5	2	1	12 50°C/122°F 2.5	2	30	1	16	99	10	120								
Fast @2500rpm	Time (min) Temp Fill (L)	1	1	26 55°C/131°F 2.5	2	1	2 2.5	2	1	10 50°C/122°F 2.5	2	30	1	3	82	7.5	120											
Fast Eco @2500rpm	Time (min) Temp Fill (L)	1	1	11 45°C/113°F 2.5	2	1	3 2.5	2	1	9 45°C/113°F 2.5	2	25	1	3	62	7.5	120											
Rinse @2300rpm	Time (min) Temp Fill (L)	1	1	7 2.5	2	11	2.5																					

### 3.1 Chassis

The DishDrawer™ chassis is one complete assembly composed of 5 steel metal components locked together by a proprietary riveting process. The chassis exterior is made of a lacquered electro-galvanised material.

### 3.2 Drawer Fronts

Prefinished drawer fronts are formed from steel blanks. The drawer fronts are attached to the tub by means of formed hooks and two pins that are inserted through either side of the tub.

On the integrated model, the front panel supplied on each drawer is the mounting panel for the joinery finished drawer front. The joinery finished drawer front is supplied by the customer.

### 3.3 Electronics

In the electronic controller, the functions of controlling the motor as well as controlling the user interface console are combined into a single micro controller on the main printed circuit board.

This micro controller also controls a transformerless 85w switch mode power supply. This power supply utilises a large dropping resistor on the heater plate in conjunction with phase control of the mains voltage in order to produce a variable voltage supply for the motors, solenoids and drying fan. From this the controller can supply voltages from 16V to 85V to the various components in the DishDrawer™.

A separate 24volt dc power supply on the PCB mains filter board, (located within the mains filter housing in the lower left corner of the chassis) supplies power to the electronic controller(s). A switch mode power supply on the electronic controller converts this to 5V which powers the microcontroller and LED's.

An isolation relay is mounted on the PCB mains filter and will disconnect power to major components when signalled to by the controller under certain fault conditions. Once the fault has been cleared, it will require the power to be disconnected from the product for the isolation relay to reset.

**NOTE: - With power supplies of this nature, all components, regardless of supply voltage, should be treated as live to earth. i.e. at supply voltage.**

The user interface comprises a printed circuit board for front controls and a touch switch panel for internal controls.

The element is switched by one single pole relay. Overheat protection is provided by a thermal fuse in series with the water heater track on the heater plate. In an over-heat situation, this gravity fuse drops off and disconnects the water heater element from the supply voltage.

A non-serviceable fuse is mounted within the controller to provide additional safety protection.

#### 3.3.1 Tub Home Sensor

The tub home sensor determines when the tub is closed. The tub home sensor consists of an infrared transmitter and receiver mounted on the right side of electronic controller. When the tub is fully closed, infrared light is transmitted from the sender through a light pipe on the side of the tub, through a prism mounted in the chassis trim, then back through the other light pipe to the receiver. If the tub is not fully closed, the circuit is not complete and the appliance will not operate.

### 3.3.2 Touch Switches

Two touch switches are used on the secondary control panel. The one on the left is used to select the required wash cycle and the one on the right is used to turn the ECO option on or off (not on US & AA integrated models). (ECO times are not necessarily shorter than non-ECO times, but will use less energy.) They are capacitive touch switches and are supplied with an analogue signal from the controller that will change in the presence of an earthed mass (i.e. customer's finger). Eco on the integrated wireless remote model is used for the START button.

### 3.3.3 Wireless Remote (some integrated models only)

Some markets have an integrated product available with a wireless badge control instead of a door badge, this ensures a seamless clean finish for the integrated door panel.

**Signal indicator**

- A **single flash** indicates a successful signal to the dishwasher.
- **Multiple flashes** indicate that the dishwasher cannot read the signal. The remote control may be out of range.

**'Battery low' indicator**

When this flashes, the battery needs to be replaced. Use a CR2032 battery, ensuring the + symbol faces up.

**Control button(s)**

Start/Pause Button

### 3.3.4 Operation (some integrated models only)

You can operate the DishDrawer in two ways:



**EITHER**  
by using the button  
on the drawer control panel

<b>Start/resume wash</b>	1 Press . 2 Close the drawer. The wash will start.
<b>Pause wash</b>	<i>You can only pause the wash with the remote. See opposite.</i>
<b>Cancel wash</b>	1 Pause the wash with the remote. 2 Open the drawer, then press and hold  until you hear a quick double beep. <i>Any water in the drawer will automatically drain when you close it.</i>
<b>Set Delay start</b>	To delay the start of a wash by 1 to 12 hours: <ul style="list-style-type: none"> <li>▪ Press and hold . Count the beeps as the dishwasher emits them (each represents 1 more hour of delay) and release the button when you have reached the desired delay time.</li> <li>▪ The indicator of the selected wash program will flash to show that Delay start has been set.</li> <li>▪ The wash will start once the delay time is over, provided the drawer is closed.</li> </ul>
<b>Cancel Delay start</b>	Press and hold  until you hear a quick double beep and the indicator of the selected wash program goes out.



**OR**  
by using the remote  
control button

<b>Start/resume wash</b>	1 Close the drawer. 2 Press . The wash will start.
<b>Pause wash</b>	Press . <i>After pausing a wash, wait for 3 beeps before opening the drawer. Forcing it open in mid-cycle may cause damage or injury.</i>
<b>Cancel wash</b>	Press and hold  until you hear a quick double beep. <i>Any water in the drawer will automatically drain.</i>
<b>Set Delay start</b>	<i>You can only set Delay start on the drawer control panel. See opposite.</i>
<b>Cancel Delay start</b>	Press and hold  until you hear a quick double beep.

### 3.3.5 Wireless Receiver

The wireless badge receiver is built into a badge isolator housing and is a specific part number for the wireless badge models. This is identified by the part number shown on the label.

( for replacement refer section 9.30)

**NOTE:** For each integrated product with the wireless badge, there is only one remote and one receiver, regardless of whether it is a single or double product.

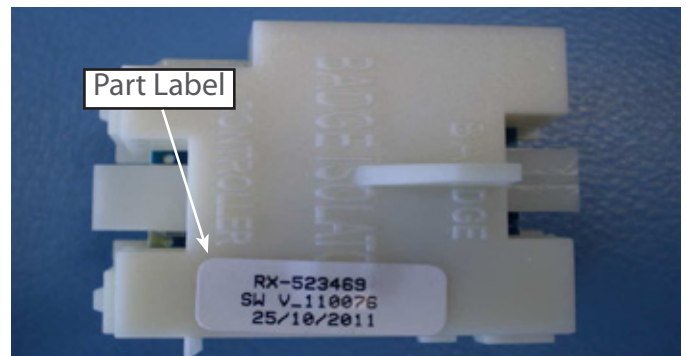

## 3.4 Motor

The motor is a fully electronically controlled 80V, 60w, 3 phase, 6 pole brushless DC motor, running on wash at between 2200 - 2800 rpm depending on the cycle selected, and at approximately 5000 rpm on drain.

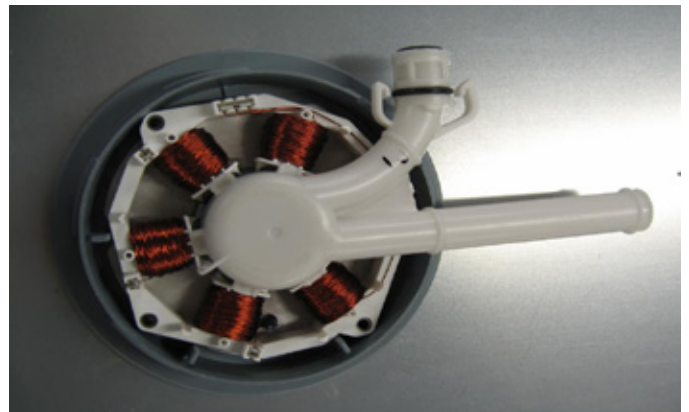

### 3.4.1 Rotor

The rotor is a four-pole permanent magnet rotor with a graphite bearing at each end of the vertical shaft. At the lower end of the rotor shaft is the drain impellor and at the upper end is the wash impellor.

There is an O-ring around the top edge of the motor rotor which seals against the filterplate.

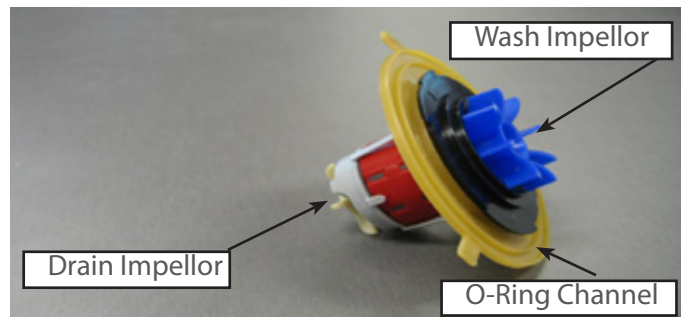

### 3.4.2 Spray Arm

The spray arm is shaped for most efficient water flow. The holes are positioned for best penetration into the wash load, with the water jets angled to ensure the spray arm rotates at the most efficient speed. There are 2 sluicing jets located at the bottom of the spray arm to direct soils into the drain filter.

The spray arms rotate at approx 11 rpm.

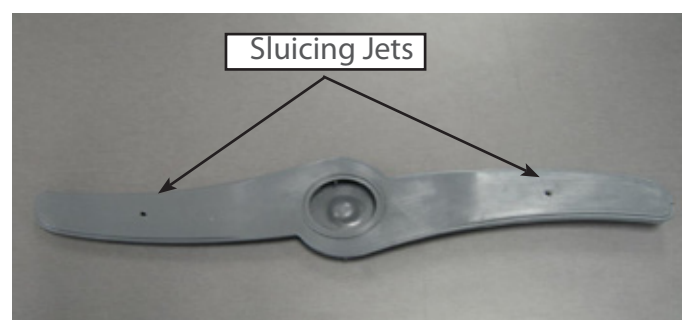
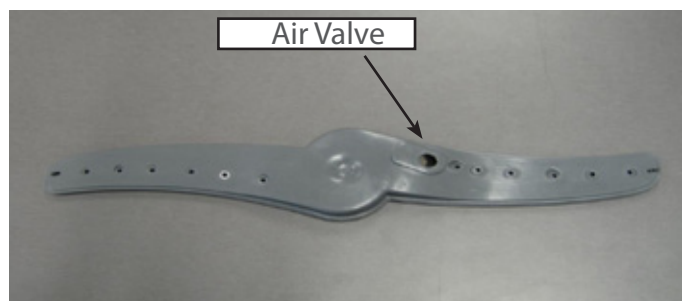

### 3.4.3 Filter Plate

The filter plate is a stainless steel disk positioned below the dish rack and spray arm and completely encompasses the base of the tub.

The drain filter has a rubber over mould around the edge to reduce soil re-depositing. Between the filter plate and rotor an o ring is also fitted to ensure a tight fit to reduce water leaks. These improvements will ensure a better wash performance.

The drain filter fits tightly into the filter plate, due to the rubber over mould around the edge.

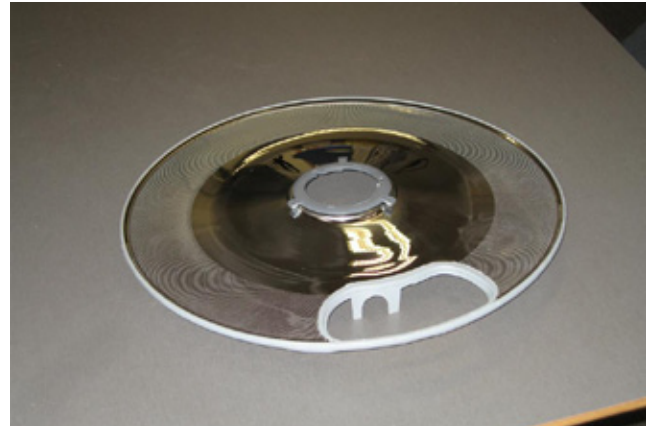

### 3.4.4 Drain Filter

The tub has vanes that swirl the water around and over the filter plate. At the front of the tub, located as part of the filter plate, is the drain filter.

The drain filter is secured into the filter plate over mould which helps sealing.

Large soils collect in the drain filter and only smaller soil flows through its micro-mesh filter, eliminating re-depositing of soil during the wash.

The drain filter should be regularly checked and cleaned.



## 3.5 Lid System

The lid is a single piece of polymer plastic with a diaphragm/seal co-injection moulded into it. The centre of the lid can move relative to the seal. Each side of the lid is clipped into a yoke, which is in turn connected to a worm drive lid actuator assembly containing a small brushed DC 24 volt motor.

When the product is first plugged in and switched on at the wall, the lid motors are powered up to ensure that the lid is fully raised.

### 3.5.1 When Activated

At the beginning of the wash cycle, both lid motors are powered up to pull the lid down onto the tub flange in approx 2 -3 seconds. The lid remains down for the duration of the wash and is only lifted when the DishDrawer beeps to signal the end of the cycle, or if the cycle is paused to gain access to the tub.

### 3.5.2 During a Power Failure

If power to the DishDrawer™ fails with the lid down, the tub can still be forced open manually if access is required. It is very difficult however to close the tub again without raising the lid. The lid actuators can be wound up manually with the tub fully removed. Failure to raise the lid before closing the drawer can result in the lid seal being damaged.

## 3.6 Tub

The tub is the main cavity where all the wash activity occurs. The tub is a polymer plastic receptacle that houses the basket ware which includes adjustable cup racks and basket with fold down tines along with a wash pump and spray arm at the base. The tub also has guide vanes around its walls which direct falling water from the wash cycle in a clockwise direction around the filter plate. This clears the filter plate of food particles and washes them into the sump where they are trapped by the drain filter or pumped out during the drain cycle.

## 3.7 Filling

### 3.7.1 Water Inlet

The tub of the DishDrawer™ fills by a single water inlet hose. Hot water connection is recommended for USA and Japanese products, and cold water connection recommended for the Australasian, UK and European products. From the connection to the water supply tap in the kitchen, the inlet hose enters the cabinet of the dishwasher at the base, onto a dual water valve.

Each tub is supplied water independently via one of the dual valve coils and a fill hose that runs through a customised link assembly at the back of each tub and travels along the base of the tub under the wiring cover to the front. At the front of the tub, the fill hose connects to the water softener (if fitted) then to the detergent dispenser which directs water into the tub.

Depending on the market and cycle chosen, the product fills through the pre-rinse section of the dispenser for the pre-rinse cycles and secondly through the main wash section for all other cycles.

In a double product the controller allows only one inlet valve to operate at a time. This has been done to reduce EMC emissions, the top tub has priority.

**Note:** This restriction does not apply in diagnostic mode.



### 3.7.2 Dispensing Detergent and Rinse Aid

The dispenser is mounted in the front of the wash tub, and is held in place with 2 brackets and 6 torx screws.

The dispenser consists of two detergent chambers, the smaller one for the pre rinse and the larger one is the main wash bucket.

The detergent dispenser door is opened manually to fill the detergent bucket, and closed manually.

There is a positive displacement pump unit and storage tank incorporated within the dispenser to supply rinse aid.

The rinse aid volume is adjustable through the option adjustment mode (refer section 4). A glowing red light on the tank filler cap indicates an empty rinse aid tank.

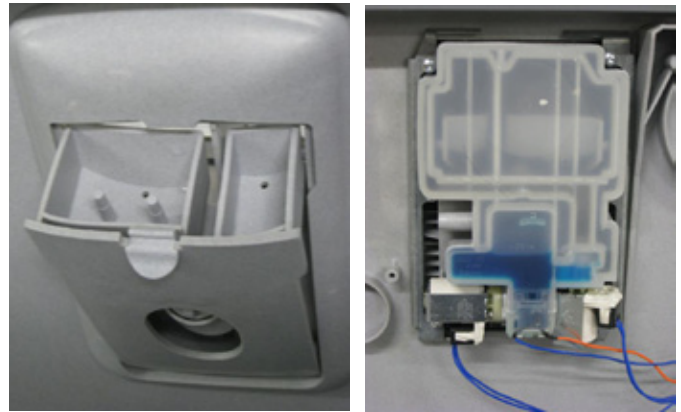

### 3.7.3 Amount of Water

The tub fills with approximately 2.5 litres (0.8 US gallons) of water, almost level with the base of the spray arm. Once the level is reached, the wash pump (which is load sensed via the electronics) becomes primed and pumps the water through the spray arms causing them to rotate.

The load on the wash pump is continually monitored through the electronics, and the wash level adjusted if necessary.

If the wash pump loses prime, the electronics will top up the water level by opening the fill valve for approx 5 seconds, it will do this 3 times before carrying on regardless.

In low water pressure situations, the product will not reach a prime and may time out. In these cases the product will show a U1 fault code to the customer. (refer section 6).

### 3.7.4 Flood Protection

A flood sensor is mounted in the mains filter housing, and provides flood protection. If a flood is detected, the drain pump will run continually and an E1 fault code will be signalled to the customer.

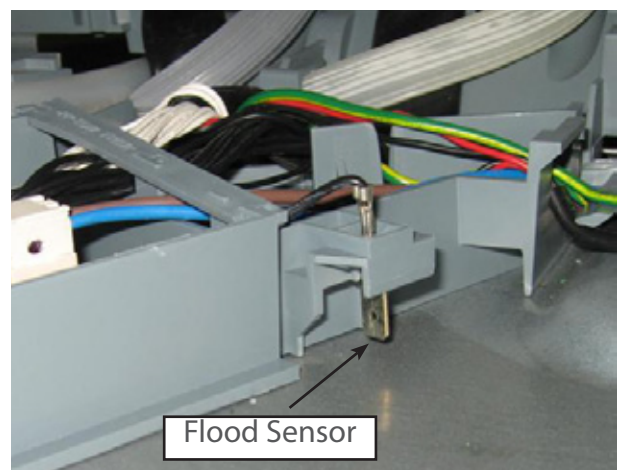

## 3.8 Heating

### 3.8.1 The Heating Element

The heating element is a porcelain enamelled steel plate, with a thick film resistive coating circuit printed onto the dry side. A gravity thermal fuse is mounted on the heater plate in series with the heating element circuit.

A large dropping resistor is also printed onto the heater plate which forms part of the controllers power supply.

The element is clamped in place by a lock nut and supports the motor at the base of the tub.



### 3.8.2 Heating the Water

The heater plate is positioned beneath the filter plate. A flow through water heating system is created during the wash cycle by water flowing through the filter plate, over the surface of the element and into the wash pump.

### 3.8.3 Maintaining the Temperature

A printed circuit board with a temperature sensitive thermistor is mounted on the heater plate. The sensor parts are unservicable and if they fail a new heater plate is required.

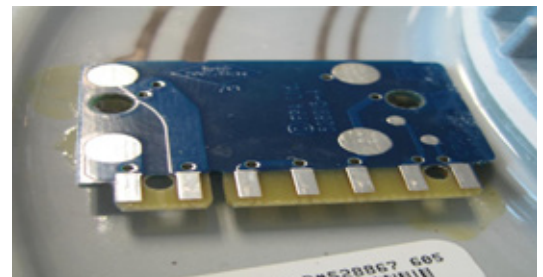

### 3.8.4 Over Heat Protection

The heater plate is only activated during a wash cycle, and is not used in the dry cycle. The temperature is monitored by the thermistor, and if a failure occurs with the electronic control of the heater plate, the over heat protection is effected by the thermal fuse on the heater plate.

The thermal fuse consists of a gravity fuse which is in series with the heater track. In an over heat situation the thermal fuse will melt and fall off the heater plate, disconnecting power to the element.





### 3.9 Motor and Heater Plate Locknuts

There are two locknuts holding the heater plate and motor housing assembly into the base of the tub, these form a watertight seal by compressing the two seals.

When reassembling the motor, it is important that a motor shim is placed between the inner locknut and the inner element seal.

The outer locknut has locations that hold the drain hose, fill hose and wiring loom in place.

### 3.10 Drain Cycle

The drain pump is a self-priming centrifugal pump that only pumps when the motor is rotating in the drain direction (anti-clockwise). It has a five bladed impellor pushed into a spline on the lower end of the rotor shaft.

The drain pump housing, which incorporates an inlet and outlet pipe, is welded to the motor housing, hence captivating the motor.

The inlet pipe plugs straight into the drain sump in the tub and is sealed there by a small 'O' ring.

The outlet pipe has a non-return flap valve to prevent soiled water returning to the tub.

The drain hose is an extruded blow moulded hose that is routed over the link assembly and exits out of the base of the product and is connected to a domestic drain.

The pump speed during the drain cycle is approx. 4200 rpm. In hardware output diagnostics test mode it is set to the same speed to aid diagnosing drain problems.

On a double product, the drain motor on the tub which is not being used will run for a short time during the final drain phase of a wash cycle. This is to remove any drain water that may have back flowed in to the unused tub.

This concurrent drain will not happen if the unused tub is open. If the user presses the power button after water has been placed in the tub, the product will initiate a "power off" drain and empty the tub.

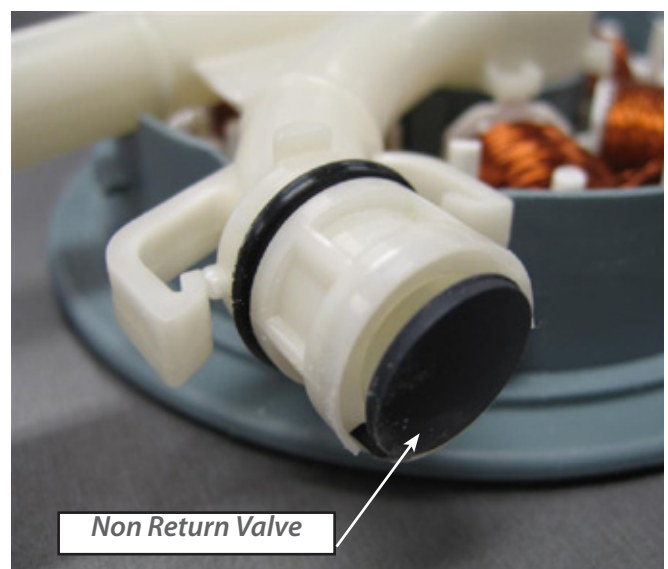

### 3.11 Filter Plate

The filter plate is a stainless steel disk positioned below the dish rack and spray arm and completely encompasses the base of the tub.

The drain filter has a rubber over mould around the edge to reduce soil re-depositing. Between the filter plate and rotor an o ring is also fitted to ensure a tight fit to reduce water leaks. These improvements will ensure a better wash performance.

The drain filter fits tightly into the filter plate, due to the rubber over mould around the edge.

#### 3.11.1 The Filter System

The tub has vanes that swirl the water around and over the filter plate. At the front of the tub, located as part of the filter plate, is the drain filter.

The drain filter is secured into the filter plate over mould which helps sealing.

Large soils collect in the drain filter and only smaller soil flows through its micro-mesh filter, eliminating re-depositing of soil during the wash.

The drain filter should be regularly checked and cleaned.

#### 3.11.2 Removing and Cleaning the Drain Filter and Filter Plate

The drain filter can be emptied with the dish rack in place by removing the cutlery basket and opening the plastic section of the dish rack.

To remove the drain filter pull upwards to release, clean under running water, when refitting ensure the drain filter sits flush with the filter plate.

The filter plate is removable for cleaning by removing the dish rack and spray arm and unlocking the locknut by turning it anti-clockwise. Turning it too far will also release the rotor and may allow it to be lifted out with the filter plate.

Clean under running water. When refitting ensure the 3 inner locking pins on the lock ring are securely fitted.

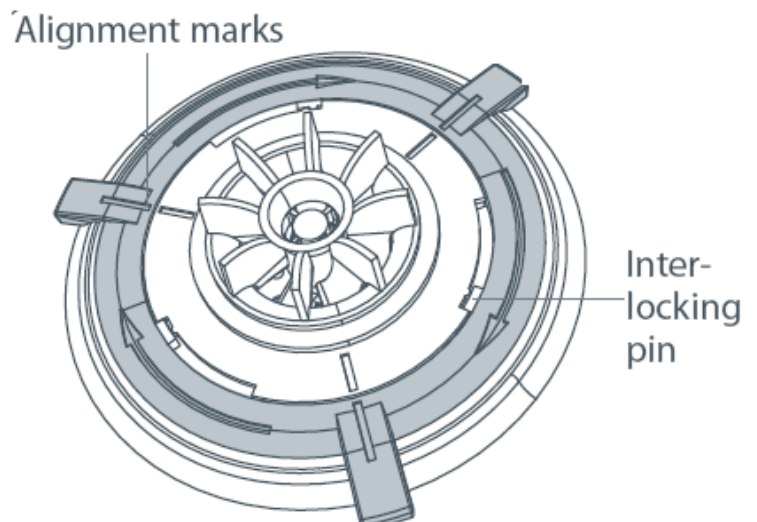

### 3.12 Drying Cycle

Immediately after water from the final hot rinse has been drained from the tub, the drying cycle begins.

The drying fan draws air through the vent in the rear into the tub where it absorbs water from the dish load. The moisture-laden air is then mixed with a larger quantity of ambient air (drawn from the kitchen), to minimise the amount of vapour visible when air is exiting from the bottom of the drawer front.

A flap valve is located in the fan housing. This is closed to prevent moist air from entering the space behind the door panel during the wash, reducing the possibility of damage to the controller and LCD. It opens whenever the fan is running.



The fan runs continuously during the drying cycle for various times depending on the program selected, and will restart if the tub is opened and closed again. After the wash program is complete (when it beeps and the LCD shows 00), the lid drives up, and the fan continues to run for anything up to 120 minutes depending on the program, but will not restart if the tub is opened or if a button is pressed.

**NOTE:** The vented integrated single product does have a dwell/pause phase before commencing the fan, this is to allow the water to condense back onto the tub.

#### 3.12.1 Integrated Single Drawer Venting (some models only)

Some single integrated models (depending on market) have a vent which runs internally inside the product and vents the air through the rear of the product via an exhaust pipe. This pipe is connected to the product at an elbow and will vent the air out through the joinery kickstrip.

This venting allows a longer door to be fitted to the customers joinery, reducing the required panel gap at the front of the product.

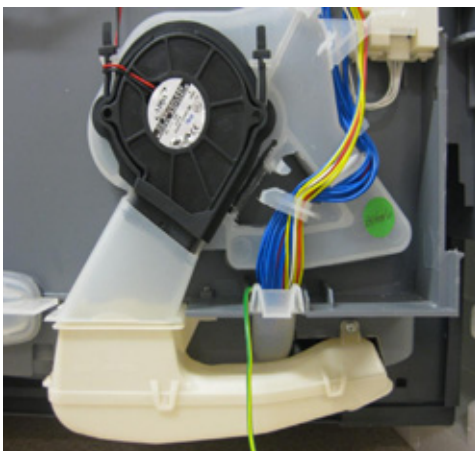

### 3.13 Water Softener (if fitted)

The Water Softener uses a softening material (resin) to prevent most of the elements that cause hard water from being present in the wash water. The resin can only treat a limited amount of water before it needs to be regenerated. Regeneration is achieved by pumping salty water (brine) through the resin, and flushing away the hard elements to the drain. The process of delivering softened water, and regeneration of the resin is controlled by the electronic controller.

Delivering Softened Water: - Supply water arrives from the inlet valve then through an inline Strainer to remove large deposits. The strainer is attached to the water softener by an inlet spigot.

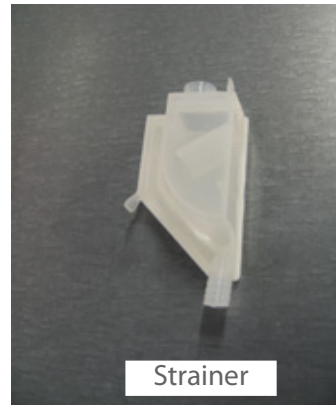
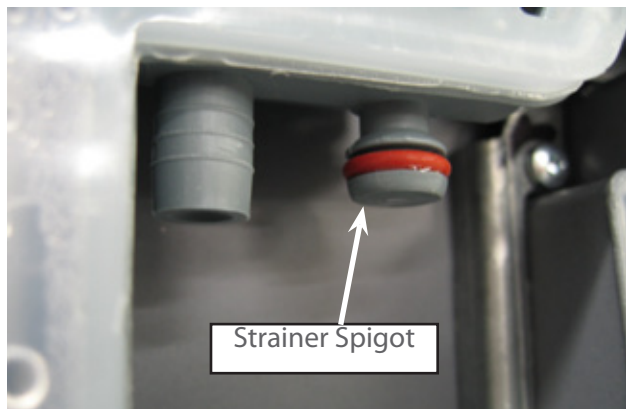

**NOTE:** *The strainer is a replaceable part, and must be replaced if blocked.*

In the water softener the water passes through an air break and a diverter valve. It is then either directed through the resin to the dispenser as softened water, or directly to the dispenser, then into the tub. The electronic controller measures the volume of water treated soft water, and adds an appropriate amount of non-treated hard water, to deliver a mix that is at the required hardness according to a pre-determined schedule. Water is treated according to its supply hardness. The customer is able to select one of 5 supply hardness settings in option adjustment mode.

Regeneration:- Regeneration is triggered when the amount of water that has been treated since the last regeneration nears the capacity of the water softener. The quantities treatable for each of the five settings of supply hardness have been predetermined, and are stored in the electronic controller. When triggered, immediately after filling for the main wash, the brine pump is activated and delivers a volume of salty water into the resin, at an amount appropriate to the hardness setting. The frequency of the pump is 3 Hz, and makes a slight rattling sound. Later in the wash cycle, the resin is flushed with supply water, and the by-products of regeneration are delivered into the wash water, and drained with it away to waste. During the flush the fill valve turns on and off alternately for 5 seconds for a number of times depending on the hardness setting. Normal treatment of incoming water then resumes.

Salt:- The customer is required to fill the salt tank with dishwashing salt from time to time. Salt is used in the water softener by mixing it with water to produce the salty water (brine) used in regeneration. When the salt level is low, a salt level detector causes a glowing red light to appear in the salt bung, and a "Salt" symbol appears in the LCD if one is fitted. When this happens, the customer should remove the salt bung, and using the salt container provided, pour salt into the salt reservoir until salt can be seen at the opening. The "Salt" symbol on the LCD will disappear and the red light will not be visible when the salt tank bung is replaced. In areas where the supply water is moderately hard, 21 dH (degrees of hardness) or 375 parts per million, water softener setting 3) the salt reservoir will need to be filled about once a month, and in harder areas more frequently. Delivery of treated water from one fill of the salt reservoir:

240 litres at 30 – 100 ppm from 375 ppm supply water (setting 3)

144 litres at 30 – 100 ppm from 625 ppm supply water (setting 5)

#### 4.1 How to Change the Setup Options (Classic, Designer & Integrated models)

(Not Wireless Model)

##### 4.1.1 Rinse Aid, Water Supply Hardness, Auto Power, End of Cycle Beeps, Closed Drawer Option, Clean/Dirty Dish Symbol.

To enter this setup mode, press POWER, then hold the ECO touch switch and KEYLOCK button simultaneously for 5 seconds, ensuring that ECO is pushed first. Once the setup mode is entered a beep is emitted and the LCD displays the letters rA on classic models only. Pushing the START/PAUSE button allows the user to scroll through and change the following options:-

- Rinse Aid Setup (rA)
- Water Supply Hardness Setup (hd) – only available on water softener models
- Auto Power Option (AP)
- End of Cycle Beeps (EC)
- Closed Drawer Option (Ld).
- Clean/Dirty Dish Symbol (dS)

Note: there is no dry enhancement mode.

On a Designer or Integrated DishDrawer™, where there is no display, the user can still tell which option they have chosen by using the lights showing on the integrated badge or secondary display panel as follows:-

<i>Integrated</i>			<i>Designer</i>	
<i>Option</i>	<i>Light Colour</i>	<i>Secondary Panel</i>	<i>Light Colour</i>	<i>Secondary Panel</i>
<i>Rinse Aid Setup</i>	<i>Red Light above Start /Pause</i>	<i>1-5 LED's will show set level</i>	<i>Blue light above start pause</i>	<i>1-5 LED's will show set level</i>
<i>Water Supply Hardness</i>	<i>Green light above start pause</i>	<i>1-5 LED's 0 LED's is option off</i>	<i>Red light above start pause</i>	<i>1-5 LED's 0 LED's is option off</i>
<i>Auto Power Option</i>	<i>Orange light above start pause + Red above ECO</i>	<i>All LED's is option on No LED's is option off</i>	<i>Purple light above start pause + Red above ECO</i>	<i>All LED's is option on No LED's is option off</i>
<i>End of Cycle Beeps</i>	<i>Green light above start pause + Red above ECO</i>	<i>All LED's is option on No LED's is option off</i>	<i>Blue light above start pause + Red above ECO</i>	<i>All LED's is option on No LED's is option off</i>
<i>Closed Drawer Option</i>	<i>Red light above start pause + Red above ECO</i>	<i>All LED's is option on No LED's is option off</i>	<i>Red light above start pause + Red above ECO</i>	<i>All LED's is option on No LED's is option off</i>

Push POWER at any time to exit this setup mode.

##### 4.1.2 Rinse Aid Setup (rA)

The current rinse aid setting is shown using the red LEDs on the touch switch panel.

The amount of rinse aid dispensed into a rinse cycle can be varied to suit the level of hardness of the local water supply. It can be set to 1 - 5 dispensing levels.

(1 = approx 0.5mls (1/10 teaspoon) of rinse aid, 5 = approx. 2.5mls (½ teaspoon) of rinse aid.

Push KEYLOCK to advance the rinse aid setting. Once the desired setting is achieved, push POWER to exit. The rinse aid index is stored in EE memory, so even with the power removed the rinse aid level is retained.

#### 4.1.3 Water Supply Hardness Setup (hd)

The current supply hardness setting is shown using the red LEDs on the touch switch panel. One of five settings should be selected according to the known hardness of the supply water.

DishDrawer Setting	Grains per Gallon	Parts per Million
No LED	0-6	0-150
1 LED	6-14	150-250
2 LED	14-20	250-350
3 LED	20-26	350-450
4 LED	26-32	450-550
5 LED	32-36	550-625

**NOTE:** No LED = Water Softener turned off, continuous bypass of softener

Push **KEYLOCK** to advance the Water Softener setting. Once the desired setting has been achieved, push **POWER** to exit.

Selection of a setting affects how the electronic controller diverts supply water, how much water is treated, and how much salt is used in regeneration, in a manner that optimises the performance of the water softener.



## 4.2 Option Adjustment Quick Reference Charts

### 4.2.1 Classic Models

There are 6 user options



















To enter the option mode, check that there is no wash underway, press the power button then open the drawer. Press the Eco button first with one finger, then the Keylock button with another finger, hold both until one long beep sounds, then release the buttons.

You are now in the rinse aid option of the preference options menu., to scroll to the next option push the  button.

To change the settings in the option use the Keylock button.

Once the selected option and settings are selected, to save push the Power button.

To exit the option at any time push the Power Button.

Which option am I in?	rA	hd	AP	EC	Ld	dS
Possible settings	1 to 5	0 to 5	On or Off	On or Off	On or Off	On or Off
NZ, AU, US, CA Secondary Panel	 HEAVY NORMAL FAST DELICATE RINSE 4 indicators lit = setting is 4		On  Off 	On  Off 	On  Off 	On  Off 
UK, IE, EU Secondary Panel	 4 indicators lit = setting is 4		On  Off 	On  Off 	On  Off 	On  Off 

rA= rinse aid, hd= water softener, AP= auto power, EC= end of cycle beeps, Ld= closed drawer auto lock, dS = clean dish indication.

### 4.2.2 Designer Models

There are 5 user options



























To enter the option mode, check that there is no wash underway, press the power button then open the drawer. Press the Eco button first with one finger, then the Keylock button with another finger, hold both until one long beep sounds, then release the buttons.

You are now in the rinse aid option of the preference options menu., to scroll to the next option push the  button.

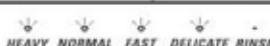
To change the settings in the option use the Keylock button.

Once the selected option and settings are selected, to save push the Power button.

To exit the option at any time push the Power Button.

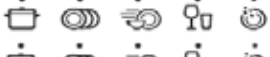
Option	Rinse aid	Water softener*	Open drawer auto power-on	Beeps at end of wash	Closed drawer autolock
Which option am I in?	   	   	   	   	   
Possible settings	1 to 5	0 to 5	On or Off	On or Off	On or Off
NZ, AU, US, CA Secondary Panel	 HEAVY NORMAL FAST DELICATE RINSE 4 indicators lit = setting is 4		On  Off 	 HEAVY NORMAL FAST DELICATE RINSE	
UK, IE, EU Secondary Panel	 4 indicators lit = setting is 4		On  Off 		

### 4.2.3 Integrated Models

There are 5 user options:



















































To enter the option mode, check that there is no wash underway, press the power button then open the drawer. Press the Eco button first with one finger, then the Keylock button with another finger, hold both until one long beep sounds, then release the buttons.

You are now in the rinse aid option of the preference options menu., to scroll to the next option push the  button.

To change the settings in the option use the Keylock button.

Once the selected option and settings are selected, to save push the Power button.



To exit the option at any time push the Power Button.

Option	Rinse aid 	Water softener 	Open drawer auto power-on 	Beeps at end of wash 	Closed drawer autolock 
Which option am I in?	red  unlit 	green  unlit 	orange  red 	green  red 	red  red 
Possible settings	1 to 5	0 to 5	On or Off	On or Off	On or Off
GB, IE, EU Secondary Panel	     4 indicators lit = setting is 4		On      Off     	         	         

### 4.2.4 Integrated with Wireless Remote Control

There are 3 user options available:

To enter the option mode, make sure no wash is underway and open the drawer.

Press the  button first with one finger, then the  button with another finger, hold both until one long beep sounds, then release the buttons.

You are now in the rinse aid option of the preference options menu.

To change the rinse aid setting press the  button, which will increase or decrease the amount of LED's on the secondary control panel, there are 5 dispensing levels (1 LED = approx 0.5mls (1/10 teaspoon) of rinse aid, 5 LED's = approx. 2.5mls (1/2 teaspoon) of rinse aid.

To scroll to the next user option press the  button







You are now in the water softener water hardness setting of the preference options menu.

To change the settings press  button, which will increase or decrease the amount of LED's showing on the secondary panel.

There are 5 settings available, ensure you set the water softener up depending on the hardness of the incoming water supply.

DishDrawer Settings	Grains per Gallon (gpg)	Parts per Million (ppm)
No LED	0-6	0-100
1 LED	6-14	100-250
2 LED	14-20	250-350
3 LED	20-26	350-450
4 LED	26-32	450-550
5 LED	32-36	550-625



Option	Rinse aid 	Water softener* 	Beeps at end of wash 
Possible settings	1 to 5	0 to 5	On/Off
NZ, AU, US, CA Secondary Panel	 HEAVY NORMAL FAST DELICATE RINSE 4 indicators lit = setting is 4	 HEAVY NORMAL FAST DELICATE RINSE 3 indicators lit = setting is 3	On  HEAVY NORMAL FAST DELICATE RINSE Off  HEAVY NORMAL FAST DELICATE RINSE

To scroll to the next user option press the  button.



You are now in the end of cycle beeps setting of the preference options menu.

To change the setting press the  button, all LED's on = end of cycle beeps on, all LED's off = end of cycle beeps off.

To save or quit the menu, press and hold the  button until a beeps sounds and the control panel reverts to showing the wash program currently selected.

\* This option is disabled on models without a water softener, the option will appear in the sequence of options but cannot be adjusted. (refer to previous page)

## Closed Drawer autolock using the remote control

The Closed Drawer autolock feature will lock the dishwasher when the drawer is closed. *To enable this feature* - with the drawer closed (and no wash program or delay start is active), press and hold  on the remote for **6 seconds** until you hear a sequence of 4 beeps together. Ignore any beeps prior to the 6 seconds. The drawer is now locked. *To unlock*, press  once. You will hear a sequence of 4 beeps together. The drawer is now unlocked.

- On double products, the drawers must be locked independently.
- If the power to the dishwasher is disconnected, the drawer will remain locked.
- Note: this feature is highly recommended if the dishwasher is to be used in motor homes.

### 5.1 DishDrawer Diagnostics

(Classic, Designer & Interated models only)  
Wireless remote models refer p34.

DishDrawer™ diagnostics can only be entered in Power Off mode, i.e. when there is no display on the LCD, or the badge LEDs are off.

Note: If the product has been powered off at the wall due to a fault code error, once power is turned back on, wait 10 seconds before trying to enter diagnostics, as the product will be doing a self check in this time, and will not allow diagnostics to be entered.

Diagnostics is entered by holding the **KEYLOCK** and **START/PAUSE** buttons simultaneously for 5 seconds. Ensure that **KEYLOCK** is pushed first.

There are currently four levels of diagnostics. To move to the next level press **POWER**. To enter a level, press **START/PAUSE**. Once a level has been entered, pressing **POWER** will exit diagnostics completely. If no level is entered, then the display will cycle through the four levels and exit after the last. On entering diagnostics mode, the first level is the display mode:

#### 5.1.1 Display Mode

In this mode all LED's and LCD segments (except keylock) are illuminated in the display. On flat door and Integrated models the Start/Pause button is displayed blue and all touch panel LED's are on.

Press the **START/PAUSE** button to successively display (for 3 seconds) the following:

Current Fault  
Current fault sub code  
Previous Fault  
Previous fault sub code

Refer to section 6 for fault codes and sub codes.

Press the Keylock button to:

Clear the Current Fault, when completed a beep is sounded. This action moves the current fault into the previous fault while clearing the current fault. To clear the previous fault code, press **KEYLOCK** once more until the beep is sounded.

Warning: Once a fault code has been cleared, it is permanently removed from memory and cannot be recovered.

Press **POWER** to advance to the next level.

#### 5.1.2 Hardware Output Mode (HO)

This level tests all the hardware outputs and inputs. The LCD models will display 'HO' in the display. The flat door models and integrated models will show the heavy, regular, fast, delicate and rinse LED's on the secondary panel.

Press **POWER** to skip hardware diagnostics and advance to the next level.

Press **START/PAUSE** to enter hardware diagnostics.

Once hardware diagnostics has been entered, letters in the LCD display indicate the current hardware output being tested. For integrated models, the LED's on the touch switch panel indicate the hardware output being tested, using binary encoding, as shown in the table on the following page.

Hardware Output mode will monitor the power supply current when any (and only) one of the fill valve, detergent diverter, water softener, wash/drain motor, drying fan is being operated, so do not run combinations of outputs.

If the current is too high or too low, a fault with a component is present, and the controller will beep with a long low tone repeated every second.

Different combinations of outputs can be switched on or off together, but the controller will prevent higher current drawing components such as the wash pump and the lid motors being turned on together.

Press **START/PAUSE** to advance to the next hardware output.

Press **KEYLOCK** to turn the currently displayed output on or off. If the green LED on integrated or blue LED on designer above start/pause button is displayed, then that output has been switched on, and if it is not displayed then that output is off.

Press **POWER** to exit at any time (all outputs will be switched off on exit).

The LCD display and touch switch panel LEDs are illuminated to correspond to a particular hardware device. The following table details the display order of the test.

LCD	Heav	Norm	Fast	Del	Rinse	Hardware Output
bL	Off	Off	Off	Off	<b>On</b>	Backlight
Er	Off	Off	Off	<b>On</b>	Off	Element Relay (turns off after 5 seconds)
Ld	Off	Off	Off	<b>On</b>	<b>On</b>	Lid Motors (will run up to 10 seconds)
dd	Off	Off	<b>On</b>	Off	Off	Detergent Diverter Valve
FU	Off	Off	<b>On</b>	Off	<b>On</b>	Fill Water Valve
P1	Off	Off	<b>On</b>	<b>On</b>	Off	Motor Wash direction 2200-2800 rpm (will not run if the tub is open)
P2	Off	Off	<b>On</b>	<b>On</b>	<b>On</b>	Motor Drain direction 4200 rpm (times out after 255 seconds.)
rd	Off	<b>On</b>	Off	Off	Off	Rinse Aid Dispenser (dispenses according to current user setting)
dF	Off	<b>On</b>	Off	Off	<b>On</b>	Drying fan
LE	Off	<b>On</b>	Off	<b>On</b>	Off	Rinse Aid and Salt Tank LEDs
C1	Off	<b>On</b>	Off	<b>On</b>	<b>On</b>	Water Softener Diverter Valve
C2	Off	<b>On</b>	<b>On</b>	Off	Off	Water Softener Brine Pump
C3	Off	<b>On</b>	<b>On</b>	Off	<b>On</b>	Water Softener Brine Valve
A1	Off	<b>On</b>	<b>On</b>	<b>On</b>	Off	Rinse Aid Pump (operates as a valve for diagnostic purposes only)
°C	Off	<b>On</b>	<b>On</b>	<b>On</b>	<b>On</b>	Displays current water temperature.
°E	<b>On</b>	Off	Off	Off	Off	Displays controller rail voltage

(C3 is used in the factory to empty the water softener before the product is packed.)

**WARNING:** Take care when running individual components not to overload them. It is advisable to place some water in the tub before turning the element on.

**Tub Home Sensor Test:** At any time during HO test mode the Keylock symbol on the LCD display (Keylock LED on integrated badge) indicates the tub position. On = closed, off = open.

To skip to the next level, press POWER button:

### 5.1.3 Fast Cycle (FC)

**WARNING:** Only run this cycle if connected to the water supply. This level runs an 8-minute fast test cycle.

Flat door and Integrated models will show the heavy, normal, delicate and rinse LED's.

Press **POWER** to skip Fast Test Cycle and advance to the next level.

Press **START/PAUSE** to enter Fast Test cycle.

Once the fast test cycle is selected, the DishDrawer™ goes into standby mode and 8 minutes will be showing on the display. The test cycle is started by pressing START/PAUSE, and the following components are run during the 8 minute cycle that follows: - Lid motors, fill valve, detergent diverter, wash motor, element, drain motor, drying fan.

To skip to the next level, press **POWER** button.

### 5.1.4 Continuous Cycle Mode (CC)

In this level the DishDrawer™ can be run continuously in any wash cycle. Once the cycle has finished, the DishDrawer™ automatically restarts the same wash cycle.

Press **POWER** to skip continuous cycle. As this is the last level, doing this will exit diagnostics. Press **START/PAUSE** to enter continuous cycle.

Once selected, the backlight turns on and off at a 2 second rate to indicate the DishDrawer™ is in continuous cycle and the cycle starts straight away (for integrated models the LED above the start/pause button will be orange instead of green to indicate the DishDrawer™ is running in continuous cycle). It will run the last cycle that had been selected prior to going into diagnostics mode.

If it is wished to run a different cycle, it will be necessary to exit diagnostics, turn the DishDrawer™ on as normal, and select the cycle required. Then turn the DishDrawer™ off again, re-enter diagnostics and restart the continuous cycle mode as above.

**NOTE:** Pressing **KEYLOCK** before starting will make the product cycle through all wash cycles.

Press **POWER** to exit at any time.

#### Cycle Count Retrieval

(Not available on integrated or flat door models.)

To display the cycle count on the LCD screen, press the **START/PAUSE** button at any time the program is running. The two bytes of the cycle count will be displayed alternately.

To calculate the total DishDrawer™ cycle count, use the formula below.

Cycle Count = Low byte + (200 x High byte).

The first byte displayed is the low byte

Eg. Low byte = 156 (backlight OFF)  
High byte = 2 (backlight ON)  
Cycle count = (200 x 2) + 156 = 556.

### 5.1.5 Temperature and Voltage Display

(Not available on integrated or flat door models.)

During a wash cycle, the current water temperature or the power supply rail voltage of the controller can be displayed on the LCD instead of the time remaining.

To enter temperature/voltage display mode, start a wash cycle as normal. Initiate a keylock by pressing and holding the **KEYLOCK** button for 4 seconds.

Once in keylock mode, press and hold **START/PAUSE** for 8 seconds to enter temperature display mode. The display now alternates between a °C symbol and the water temperature. Pressing the **START/PAUSE** button again changes the display to alternate between an °E symbol and the power supply rail voltage of the controller.

To cancel temperature/voltage display mode, press the **POWER** button.

### 5.1.6 Show Off/ Showroom Wash Mode

Only available on LCD models only

This mode initiates a shop show off display and wash operation demonstration.

With the DishDrawer™ powered up and turned on, the show off mode is entered by pressing and holding the **ECO** and **POWER** buttons simultaneously for 5 seconds. Ensure that **ECO** is pressed first.

The DishDrawer™ is now in the show off mode and cycles through all of the LED & LCD segments.

Pressing the **POWER** button now puts the DishDrawer™ into the showroom wash mode. Before running this mode, the tub should be filled with water until it is almost touching the underside of the spray arm. The showroom wash is started by pushing the **START/PAUSE** button whereby the following cycle is run:-

- The lid is pulled down.
- The wash motor starts and runs for 4 minutes.
- The wash motor stops.
- The lid is lifted.
- The display counts down to zero throughout this cycle.
- The DishDrawer™ turns off at the end of this cycle.

The DishDrawer™ is still in the showroom wash mode however, and it can be re-run by pushing **POWER** and then **START/PAUSE**. Once show off/showroom wash mode has been initiated, the mains power supply must be removed to exit out.

### Playing Tunes

Once in showroom mode, holding the **START/PAUSE** button down for 3 seconds will start a tune playing.

Pressing the **START/PAUSE** button again will toggle the tune between Bach and Edvard Grieg's "Hall of the Mountain King". This feature is not widely known about, may not be present in all models and may be removed in future products.

## 5.2 DishDrawer Diagnostics Wireless Badge Models

The diagnostics for the wireless badge models are accessed through the **USER SETUP FUNCTION**, to access the User Setup Function:

Open the tub

Press and hold the **PROGRAM** and **START/PAUSE** switches on the touch panel simultaneously for 5 seconds (ensure **PROGRAM** button is pressed first).

A beep will sound

The secondary touch panel will have between 1 - 5 LED's on.

### 5.2.1 Diagnostic Mode

To enter this mode:

Enter the **USER SETUP FUNCTION**, refer 5.2.

Press the **PROGRAM** button 2 times to reach the **END OF CYCLE BEEPS** option.

(Eco LED is on, other program LED's either all on, or all off).

Wait 5 seconds.

Press and hold **PROGRAM** and **START/PAUSE** button's on the secondary touch panel simultaneously for 5 seconds ( ensure **PROGRAM** button is pressed first).

The product will beep and all secondary touch panel LED's are on.

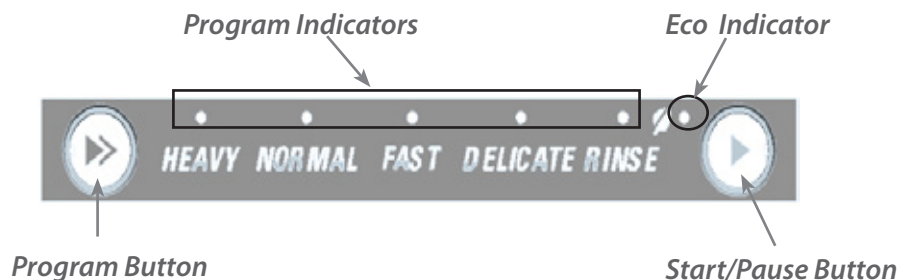

### 5.2.2 Display Mode

While running the diagnostic mode, press the **PROGRAM** button to skip to **HARDWARE OUTPUT MODE (HO)**, or.

Press the **START/PAUSE** button to select the **DISPLAY MODE**.

Press the **PROGRAM** button to successively display (for 3 seconds each)

- Current fault code, shown from Heavy through to Rinse LED's, with Eco LED off.
- Current fault sub code, shown from Heavy through to Rinse LED's, with Eco LED on.
- Previous fault code, shown on Heavy through to Rinse LED's with Eco LED off.
- Previous fault sub code, shown on Heavy through to Rinse with Eco LED on.

Press and hold **START/PAUSE** button for 5 seconds to exit the display mode to standby **USER SETUP FUNCTION** mode.

### 5.2.3 Hardware Output Mode (HO)

Press the **PROGRAM** button to skip to **FAST CYCLE MODE (FC)**, or.

Press the **START/PAUSE** button to enter HO mode.

Press **PROGRAM** button to successively select each hardware output device ( refer to p30 for device table).

Press the **START/PAUSE** button to turn a device on or off.

Press and hold the **START/PAUSE** button for 5 seconds to exit HO mode and return to standby **USER SETUP FUNCTION** mode.

#### 5.2.4 Fast Cycle Mode (FC)

1. Press the **PROGRAM** button to skip to the **Continous Cycle Mode (CC)**, or.
2. Press **START/PAUSE** button to start the **FAST CYCLE (FC)** and close the wash tub.
3. The product will start an 8 minute test cycle, and the following devices are tested:
  - lid motors
  - Fill valve
  - Detergent diverter
  - Wash motor
  - Element
  - Drain motor
  - Drying fan
4. Press and hold the **START /PAUSE** button for 5 seconds to exit the FC mode and return to standby **USER SETUP FUNCTION** mode.

#### 5.2.5 Continous Cycle Mode (CC)

1. Press the **PROGRAM** button to exit the standby mode.
2. Press **START/PAUSE** button and shut the tub to repeatedly run the currently selected wash program.

**Note:** to exit any mode at any time, push and hold the **START/PAUSE** button for 5 seconds.

## 6 FAULT CODES AND POOR PERFORMANCE

Faults are displayed on the LCD (if fitted) and are also displayed on the touch switch panel for the integrated and flat door models and remote badge models.

There are 10 "E" fault codes, which are displayed along with a spanner in the LCD (if fitted). Within the E fault are sub code faults, which help identify the failure mode and provide more information. ( refer page 38 & 39 for sub codes)

An E fault will usually require the assistance of a qualified service person.

In addition, there are 3 U (user) faults.

U1 is displayed on the LCD as a "no tap" symbol. (time out on fill is after 175 seconds)

The customer can usually rectify a U1 fault.

A U4 fault indicates an E fault with the other tub that has disabled the power supply, it will only be displayed when the **START/PAUSE** button is pressed.

In the integrated and flat door models, where an LCD is not available, the presence of a fault is indicated by a red centre (Start/Pause) LED on the badge, with the fault number indicated by the Red LEDs on the touch switch panel.

A U6 indicates that the spray arm may have become dislodged from the rotor, or, the water supply pressure to the product is too low. (time out on fill is after 175 seconds)

<i>Model</i>	<i>Maximum Water Pressure</i>	<i>Minimum Water Pressure</i>
<i>water softener model</i>	<i>1 MPa</i>	<i>0.1 MPa (14.5 psi)</i>
<i>non water softener model</i>	<i>1 MPa</i>	<i>0.03MPa (4.3 psi)</i>

Once a user fault is repaired, it can be cleared by pressing the **POWER** button. If the fault is still present, then it will not clear.

An E fault or user fault is accompanied by a continuous pulsating beep, which can be turned off by pressing the **KEYLOCK** button. This also stops the drain pump running for an E1 fault.

The last two faults are logged into EE memory.

If a tub is forced open, the product simply pauses as if someone had pressed the start/pause button.

Once the fault has been cleared, the power needs to be disconnected and reconnected to reset the isolation relay before the product can be used again.



## 6.1 Fault Code Description Chart

The following chart is a quick reference guide for fault codes. The possible causes shown are in no particular order and are for guidance only.

To read a fault code on an integrated model or flat door model refer to the LED Display column on the chart. The LED that has activated on the secondary display indicates which fault code has occurred. To make diagnostics easier, a test handle can be made for use on integrated or flat door products using a cut down handle and a DD605/DD60/DD24 PCB LCD. This will not be able to be used on DD603 products, or a DD603 test handle used on DD605/DD60/DD24 products.

Fault Code	LED Display	Fault	Possible Causes
E1	Rinse LED	The flood sensor in the base has been activated for more than 20 seconds.	<ul style="list-style-type: none"> <li>• Lid not closing</li> <li>• Overfilling</li> <li>• Foaming</li> <li>• Not draining</li> <li>• Lid seal damage</li> <li>• Dispenser or water softener seals leaking</li> <li>• Damaged water inlet or drain hoses</li> <li>• Leaking heater plate or motor seals, or drain o-ring seals</li> <li>• Yoke jammed or broken</li> <li>• Inlet hose to inlet valve connection loose</li> <li>• Inlet valve body leak</li> <li>• Heater plate damaged (chipped enamel)</li> <li>• Dry E1 - PCB mains filter, harness or connectors, electronic controller.</li> </ul>
E2	Delicate LED	The controller has not sensed the motor rotating	<ul style="list-style-type: none"> <li>• Foreign object has jammed the rotor</li> <li>• The rotor has failed</li> <li>• hall sensor or wiring fault at the hall sensor or controller.</li> <li>• The hall sensor has failed</li> <li>• Motor stator winding or connection open circuit.</li> <li>• The electronic controller has failed.</li> <li>• PCB mains filter has failed.</li> </ul>
E3	Delicate & Rinse LED's	The water temperature has been sensed as greater than 85 °C (185 °F)	<ul style="list-style-type: none"> <li>• The incoming water is greater than 85 °C (185 °F)</li> <li>• The element has failed closed circuit</li> <li>• The temperature sensor on the heater plate has failed.</li> <li>• The electronic controller has failed</li> </ul>
E4	Fast LED	No temperature increase has been sensed for about 4 hours while element is on.	<ul style="list-style-type: none"> <li>• The element is not connected</li> <li>• The element is failed open circuit</li> <li>• The temperature sensor has failed</li> <li>• The electronic controller has failed</li> </ul>
E5	Fast & Rinse LED's	Lid motor current too high during start	<ul style="list-style-type: none"> <li>• The lid is jammed up or down</li> <li>• The electronic controller has failed</li> </ul>
E6	Fast & Delicate LED's	Fan fault	<ul style="list-style-type: none"> <li>• Check fan harness connector</li> <li>• Check if fan open or short circuit</li> <li>• The electronic controller has failed</li> </ul>
E7	Fast, Delicate & Rinse LED's	Detergent diverter fault	<ul style="list-style-type: none"> <li>• Check harness connections</li> <li>• Coil is open circuit</li> <li>• Coil is short circuit</li> <li>• The electronic controller has failed</li> </ul>

Fault Code	LED Display	Fault	Possible Causes
E8	Normal LED	Solenoid fault	<ul style="list-style-type: none"> <li>• Check the harness connections at each solenoid</li> <li>• Coil is open circuit</li> <li>• Coil is short circuit</li> </ul>
E9	Normal & Rinse LED	Microcontroller fault	<ul style="list-style-type: none"> <li>• Badge isolator ( if present)</li> <li>• Detergent diverter valve</li> <li>• Check harness connections</li> <li>• MFB</li> <li>• Controller</li> </ul>
EC	Normal & Fast LED's	Communications error	<ul style="list-style-type: none"> <li>• Harness connections between the MFB and controller</li> <li>• MFB</li> <li>• Faulty top controller</li> <li>• Faulty bottom controller</li> </ul>
U1	Heavy & Rinse LED's	Water Supply	<ul style="list-style-type: none"> <li>• Water turned off</li> <li>• Insufficient water supply pressure</li> <li>• Blocked water softener filter (if fitted)</li> <li>• Spilt rinse aid causing over foam in tub</li> <li>• Incorrect detergent being used</li> <li>• Motor rotor</li> <li>• The machine is siphoning</li> <li>• Inlet valve has failed</li> <li>• Controller</li> </ul>
U4	Heavy & Fast LED's	Other tub is faulting	<ul style="list-style-type: none"> <li>• The other tub has a fault which is preventing operation of that tub.</li> <li>• No repair is required to the tub showing a U4.</li> </ul>
U6	Heavy, Fast & Delicate LED's	Spray arm not detected	<ul style="list-style-type: none"> <li>• Spray arm not sitting on rotor</li> <li>• Insufficient water pressure</li> </ul>

### 6.1.1 Sub Code Faults

Sub code faults help identify a particular fault within the main E fault code. The sub code is found by pressing the START/PAUSE button while in the diagnostic display mode, the sub code is displayed momentarily (3 sec) on the LCD (if fitted) and on the secondary panel for integrated or flat door models.



Fault Code	Sub Code	LED Display	Fault	Possible Causes
E2	01	Rinse & Eco LED	motor not rotating	<ul style="list-style-type: none"> <li>• Obstruction in motor rotor housing</li> <li>• Rotor seized</li> <li>• Hall sensor</li> </ul>
	02	Delicate & Eco LED	motor drawing too much current	<ul style="list-style-type: none"> <li>• Short in motor winding</li> <li>• Hall sensor</li> </ul>
	03	Delicate, Rinse & Eco LED	Motor not drawing enough current	<ul style="list-style-type: none"> <li>• Open circuit winding</li> <li>• harness connection</li> <li>• Motor rotor incorrectly installed</li> </ul>

Fault Code	Sub Code	LED Display	Fault	Possible Causes
E3	01	Rinse & Eco LED's	Over Temperature	<ul style="list-style-type: none"> <li>Temperature sensor</li> </ul>
E4	01	Rinse & Eco LED's	Element time out	<ul style="list-style-type: none"> <li>Element track faulty</li> </ul>
	02	Delicate & Eco LED's	Dropper resistor open circuit	<ul style="list-style-type: none"> <li>Dropper resistor open circuit</li> </ul>
E5	01	Rinse & Eco LED's	Not starting	<ul style="list-style-type: none"> <li>Wiring to lid motor</li> <li>obstruction</li> <li>Controller</li> </ul>
	02	Delicate & Eco LED's	No current	<ul style="list-style-type: none"> <li>Open circuit lid motor</li> </ul>
	04	Fast & Eco LED's	Not stalling	<ul style="list-style-type: none"> <li>Controller</li> <li>Obstruction</li> <li>Wiring</li> </ul>
E6	02	Delicate & Eco LED's	Under current	<ul style="list-style-type: none"> <li>Open circuit fan motor</li> <li>wiring</li> </ul>
	03	Delicate, Rinse & Eco LED's	Over current	<ul style="list-style-type: none"> <li>Short circuit fan motor</li> <li>Seized fan</li> </ul>
E7	02	Delicate & Eco LED's	Under current	<ul style="list-style-type: none"> <li>Wiring to detergent diverter valve</li> <li>Open circuit coil</li> </ul>
	03	Delicate, Rinse & Eco LED's	Over current	<ul style="list-style-type: none"> <li>Short circuit coil</li> </ul>
E8	02	Delicate & Eco LED's	Under current	<ul style="list-style-type: none"> <li>Wiring to solenoid</li> <li>Open circuit coil</li> </ul>
	03	Delicate Rinse & Eco LED's	Over current	<ul style="list-style-type: none"> <li>Short circuit coil</li> <li>Wiring to coil or controller</li> </ul>
E9	04	Fast & Eco LED's	ADC error	<ul style="list-style-type: none"> <li>Badge isolator controller</li> </ul>
	05	Fast, Rinse & Eco LED's	PSU over voltage	<ul style="list-style-type: none"> <li>Harness connections</li> <li>Corroded connection at controller</li> <li>Detergent diverter coil</li> </ul>
	06	Fast, Delicate & Eco LED's	software reset	<ul style="list-style-type: none"> <li>Controller</li> </ul>
	07	Fast, Delicate, Rinse & ECO LED's	Forced PSU shutdown	<ul style="list-style-type: none"> <li>Check all component terminals for damage caused by corrosion.</li> <li>Controller &amp; MFB</li> </ul>

## 6.2 Poor Dry Performance

<b>Poor Dry Performance (Non Vented)</b>			
	QUESTION	YES	NO
1	Is the customer complaining of plastic items not drying?	Advise customer that due to plastics having a low thermal mass, these items give inherently bad drying performance.	Go to Question 2.
2	Is the customer using rinse aid?	Go to Question 3,	Advise customer that the use of rinse aid will improve dry performance.
3	Is the customer using Fast or Eco cycles?	Advise customer that due to lower final rinse temperatures, dry performance is comprised when using Fast and Eco cycles (there is less residual heat for drying at the end of cycle).	Go to Question 4
4	Is the rinse aid setting high enough for the water hardness in the area?	Go to Question 5.	Turn the rinse aid up to a higher setting.
5	Using diagnostics, test the rinse aid dispenser. Is it dispensing the correct amount of rinse aid?		Replace dispenser.

<b>Poor Dry Performance (Vented Single Product)</b>		
	Complaint	Answer
1	Customer complaining about water on the floor after drying	Due to cold ambient conditions, the moist air from the external vent may cause a mist on the floor, and in extreme cold ambient conditions water can drip from the external vent.
	Gurgling	Has the flap
2	Drying fan not operating	There is a time lag of between 30-40 minutes to let the water condense within the tub before drying starts.

### 6.3 Poor Wash Performance

<b>Customers Complaint - food particles left on dishes</b>	
Cause of problem (1).	Spray arm has stopped rotating
How to resolve the problem	<p>a) One of the dishes / cutlery / utensils has fallen through the basket and jammed the spray arm. Remove the obstruction.</p> <p>b) The filter plate, drain filter, or drain filter access panel is not installed correctly and is causing the spray arm to jam.</p>
Cause of problem (2).	The product is being over loaded or incorrectly loaded with dishes.
How to resolve the problem.	Advise customer of correct loading.
Cause of problem (3).	The customer is selecting the wrong wash cycle for the soil level on the dishes.
How to resolve the problem	Advise the customer about reduced water temperatures (up to 20°C / 70°F lower) and wash times when using Fast and Eco cycles.

<b>Customers Complaint - coffee/tea stains left in cups</b>	
Cause of problem (1).	<p>Not enough detergent is being used. To remove these stains requires a stronger concentration of detergent in the water.</p> <p>More detergent is also required in hard water areas, as minerals in the hard water reduce the effectiveness of the detergent. There are also detergents available with a built in water softening agent which will work up to moderate hardness levels.</p>
How to resolve the problem.	Fill the main-wash detergent cup to the top and for best results also fill the pre-wash detergent cup. Run on normal or heavy cycles, not Eco. Use a detergent with a water softening agent.
Cause of problem (2).	The product is being over loaded, which is preventing water reaching the cups on the upper cup racks.
How to resolve the problem	Advise the customer of correct loading.

<b>Customers Complaint - dishes have blotchy marks on them that look like water stain marks, not food</b>	
Cause of problem.	Not enough rinse aid being used. The water is not soft enough during the final rinse and therefore hard water droplets containing impurities are drying on the dishes instead of running off during the dry cycle.
How to resolve the problem.	<p>Confirm that the customer is using rinse aid.</p> <p>The rinse aid may need to be turned up to a higher setting (4 or 5 lights), and for optimum dry performance, run the DishDrawer™ on normal or heavy cycles, not Eco.</p> <p>Check that the rinse aid dispenser is dispensing correctly in diagnostics.</p>

<b>Customers Complaint - glasses &amp; cutlery have a cloudy white film on them and/or plates have a white chalky film on them</b>	
Cause of problem.	Hard water and not enough detergent being used. Minerals from the water are building up on the dishes or the water softener is not set to the correct water hardness level, or is faulty.
How to resolve the problem.	<p>Once this film forms on the dishes it cannot be removed by normal running in the dishwasher. The dishes will need to be cleaned by soaking them in an acidic solution (such as white vinegar and water). Where a Water Softener is not fitted in the product: To prevent the build up re-occurring, the customer will need to fill both the main-wash and pre-wash detergent cups to the top with a power detergent, and we would recommend running on normal cycles, not Eco. There are detergents available to be used with hard water that have a softening agent built in, these powders will work up to moderately hard water.</p> <p>In problem areas with very hard water, the customer may need to use a detergent additive designed for use in hard water areas, or fit a household water softener to the incoming water supply. Where a Water Softener is fitted:</p> <p>Set the water softener for the correct local water supply hardness. Check that the water softener is functioning correctly in diagnostics.</p> <p><b>C1 Water Softener Diverter Valve</b> In hardware output diagnostics test mode: FU – turn the fill water valve on P2 – turn the motor drain on C1 – water softener diverter valve On – water bypasses the resin tank Off – water flows through the resin tank</p> <p><b>C2 Water Softener Brine Pump</b> Turn the brine pump on in diagnostics mode. Observe a small quantity of water (approx. 30 ml per min.) flowing out the bottom of the dispenser (drop the dispenser door down to observe this.) Observe a change in the water level (approximately 120ml per 4 min.) in the salt reservoir. The reservoir should pump dry of water in this time. Note: - Fill the salt reservoir with salt (and then water if not already) before performing this test.</p> <p><b>More on next page:</b></p>

**Customers Complaint - glasses & cutlery have a cloudy white film on them and/or plates have a white chalky film on them**

How to resolve the problem.

**Pipe Interrupter (Air Break) Function**

A critical component in the performance of the water softener is the pipe interrupter air break (PI). There is a certain amount of spray leakage from the PI, which is used to provide water to the salt reservoir.

If the spray is inadequate, there will be insufficient water in the salt reservoir to make brine.

If there is too much spray, then the excess bypasses the water softener and defeats the softening process by pouring untreated water straight into the tub.

To check that the amount of spray is appropriate:-

Fill the salt reservoir with water.

In diagnostics mode, turn on the fill water valve and the motor drain. Water will flow out of the dispenser into the tub, as well as out of the water softener overflow into the tub.

Observe the flow from the water softener overflow (beside the dispenser). There should be a trickle (25-100 ml per minute). With experience you can guess what is appropriate. If the trickle is outside these rates, replace the water softener, as the PI is faulty.

To check that there is water in the salt reservoir, remove the drawer front and observe the level of water in the tank. (A quick way to check that there is water in the salt reservoir is to remove the salt bung and test the water level by placing your finger down through the opening.)

**Detergent or Rinse Aid in the Water Softener**

If detergent or rinse aid is poured in to the salt reservoir it will destroy the water softener. This could also happen if the salt bung is left off or falls out. Evidence of this could be white streaks through the resin.



If the product has an LCD display, it will be displaying either a fault code or a user warning. Fault codes begin with the letter "E", user warnings begin with the letter "U", the fault code is shown with a number. e.g. E2

If the product is integrated or has a wireless remote, it will be necessary to open the tub to determine the fault code. Some faults may lock the lid in which case the tub must be opened by force. This should not cause damage, however do not attempt to close the tub with force. The fault code or user warning will be displayed on the user interface LED's on the tub flange, refer to pages 33 & 34 for the codes.

If the code indicates a user warning "U4", then this tub does not have a problem, the warning is to show the user that the other tub has a fault which has prevented that tub from operating.

If the code indicates either of the user warnings "U1" or "U6" there is no sub code. Otherwise pressing the **START/PAUSE** button will display the current fault sub code for 3 seconds before reverting back to the main fault code.

The sub code provides more specific detail on what is causing the fault, which helps in diagnosing the problem. If a sub code is being displayed, then the "Eco" LED will be on. ( refer sub code faults pages 38 & 39)

**WARNING:** Before attempting any servicing to the product, ensure the power is isolated if replacing or removing components or harnesses, always treat the product as live to earth.

**NOTE:** Vented integrated single product use a specific controller, ensure the correct controller is fitted if replacing.

### 7.1 Fault Code Problem Solving

1. This section is intended to provide information on the cause of faults in order of likelihood. After each step in the process the following procedure should be followed:
  - Cycle the power to the device.
  - Run any hardware device that have been replaced in "Hardware Output Mode" ( refer p30) for at least 10 seconds. A long low tone played indicates a fault with the component ( high pitch beeping from solenoids is normal and expected)
  - If the original fault or another fault occurs while performing step 1 & 2, move on to the next step of the process for that particular fault code. Otherwise move on to section 7.2 "completing a service" on p54.

#### 7.1.1 User Warning U1 - Water Supply

1. Check to make sure that the water supply hose is connected and the tap is turned on.
2. If there is no water in the tub, enter "Hardware Output Mode" and run the fill valve (P30 & 31). If water enters the tub then the water supply is connected, however the water pressure may still be too low for correct operation. Min pressure .03MPa (4.3psi), water softener model 0.1MPa (14.5psi).
3. If the water pressure and flow rate is inadequate, try fitting a 4 litre valve ( part #529828) which may help increase the flow to the product. In cases where water pressure is too low, the DishDrawer may need to be run at a separate time to other appliances which use water, such as washing machines.
4. Check the motor rotor is undamaged. Replace the motor rotor if necessary.
5. Check the water softener filter for blockages (if fitted) refer to p24.
6. Make sure there is no foam in the tub, If there is foam try to determine the cause, i.e. liquid detergent being used or rinse aid been spilt when customer refilling dispenser. Run the product in "Hardware Output mode" refer p30 & 31 (P2 - drain pump) while the drain pump is operating, pour warm water into the tub to help flush away excess foam.
7. To exit "HO" mode, press **POWER** button at any time.



### 7.1.2 User Warning U4 - Other Tub Faulting

1. The other tub has a fault which is preventing the operation of that tub. No action is required for the tub displaying the U4 code.

**DO NOT REPLACE COMPONENTS ON A TUB WITH THIS WARNING.**

### 7.1.3 User Warning U6 - Spray Arm Not Detected

1. Check to ensure that the spray arm is correctly located on the motor rotor and that the motor rotor is correctly installed in the motor housing.
2. Using "Hardware Output Mode" run the fill valve (P30 & 31). If water enters the tub then the water supply is connected, however the water pressure may still be too low for correct operation. Min pressure .03MPa (4.3psi), water softener model 0.1MPa (14.5psi).
3. If the water pressure and flow rate is inadequate, try fitting a 4 litre valve ( part #529828) which may help increase the flow to the product. In cases where water pressure is too low, the DishDrawer may need to be run at a separate time to other appliances which use water, such as washing machines.
4. To exit "HO" mode, press POWER button at any time.

### 7.1.4 Fault Code E1 - Flood Detected

There are two types of E1 faults, wet E1 that is usually due to a leak, or dry E1 which can be due to a component failure or wiring related fault.

#### Wet E1- Water in the Chassis Base

1. Check the tubs to ensure there is nothing obstructing the lid like large cooking utensils or large cups and glasses placed on top cup racks which extend above the tub flange.
2. Make sure the lid systems are free from other obstructions and yokes are connected, enter "Hardware Output Mode" (p30 & 31) and check operation of the lid motors on both tubs. If either of the actuators fails to operate, or are slow to operate replace the actuator. ( see p68 on procedure)
3. Check the fill level on both tubs, is the valve turning off and disconnecting the water supply, and is the tub filling to the correct level? approx 2.5litres (0.8 US gallons). The fill valve operation can be checked in "Hardware Output Mode" but run in diagnostics means the water valve will not shut off, this is done manually (refer p30 & 31), when run and switched off, does any water still leak into the wash tub? if water is still running through the dispenser when shut off then the valve diaphragm maybe leaking and valve will need replaced.
4. Check for any foam inside the tubs, if present try to determine the cause, i.e customer spilt rinse aid when filling, wrong detergent used. Try and remove as much foam as possible, this can also be done by flushing the tub, to flush the tub enter "Hardware Output Mode", select drain pump component P2 (p30 & 31) , while the drain pump is operating, manually pour warm water into the tub until the foam is removed. To exit the hardware output mode, press **POWER** button at any time.
5. Check the motor rotor that the wash impellor is intact, and that the motor rotor turns freely.
6. Check the hall effect sensor (RPS) on the motor stator, ensure this is this clipped in correctly.
7. Look for other sources of leaks, possible other leaks can be the following: lid seal, heater plate seal, wash pump seal, internal fill hose, leaking water valve body, drain hose, drain hose cuff, water softener (if fitted)
8. Remove excess water from chassis base and ensure the flood sensor is dry.

#### Dry E1 - No Water in the Chassis Base

1. Check for corrosion around the flood sensor and ensure that the flood sensor is correctly placed and not touching the chassis.
2. Check the chassis harness connections for corrosion.
3. Replace the mains filter board.
4. If the fault continues, replace the controller.

### 7.1.5 Fault Code E2 - Motor Fault

1. Check the hall sensor (RPS) is correctly located and is held firmly in place on the motor stator and that the wiring harness is connected to it.
2. Check the harness connections at the motor and at the controller for signs of any water damage, corrosion or arcing, replace if damaged and ensure the harness is connected correctly.
3. Check the resistance of the motor coils on harness P201, pin pair 1&2, 2&3, 1&3 there should be 8.0 Ohms (per winding), 16 ohms phase to phase. (refer section 9 for more detail).
4. Replace the motor stator as the readings are outside their normal ranges.

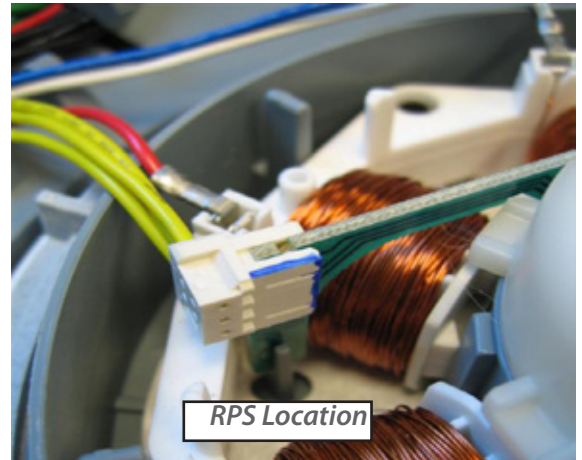

### Fault Code E2 - Sub Code 01 - Motor Not Rotating

1. Check the rotor, it should turn freely by hand, if not then check for obstructions that maybe preventing it's rotation ( refer p62 on how to remove the rotor).
2. Check the hall sensor (RPS) that it is correctly located and is held firmly in place on the motor stator and wiring harness connected to it.
3. Replace the motor rotor.
4. If the fault still occurs replace the controller.

### Fault Code E2 - Sub Code 02 - Motor Drawing Too Much Current

Prefinished models

1. Check the stator windings to ensure correct resistances, this can be done on harness P201 at the controller, check between pin 1 &2, 2 & 3, 1 & 3 the reading should be 8.0 ohms per winding, 16 ohms phase to phase. (refer section 9 for more detail.)
2. Check the hall sensor (RPS) is correctly located and is held firmly in place on the motor stator and that the wiring harness is connected to it.
3. Replace the motor rotor, place the product in "HO" mode (refer pages 30 & 31), run the fill water valve (FU) and fill the tub with approx 2.5L (0.7 gal) of water, once at the correct level switch off the valve in HO mode.
4. Lock the lid actuators (Ld) and then run the wash motor (p1) in "HO" for 10 seconds. If a long low tone is played each second then the motor stator is likely to be faulty and should be replaced. To drain the tub select p2 in HO mode and then unlock the lid actuators (Ld) when empty.
5. If the fault still occurs after the stator has been replaced, then replace the controller.
6. If the fault still persists check other loads in HO mode including the detergent diverter, rinse aid coil and the heater plate. When checking the heater plate ensure there is enough water in the tub to cover the heater plate.

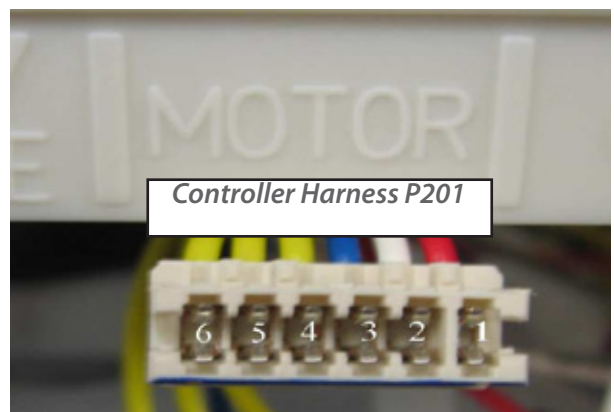

For Integrated or Flat Door Models:

1. Check the stator windings to ensure correct resistances, this can be done on harness P201 at the controller, check between pin 1 & 2, 2 & 3, 1 & 3 the reading should be 8.0 ohms per winding, 16 ohms phase to phase. (refer section 9 for more detail.)
2. Check the hall sensor (RPS) is correctly located and is held firmly in place on the motor stator and that the wiring harness is connected to it.
3. Replace the motor rotor, place the product in "HO" mode (refer pages 30 & 31), run the fill water valve (FU) and fill the tub with approx 2.5L (0.7 gal) of water, once at the correct level switch off the valve in HO mode.
4. Run the motor in drain direction (P2) for 10 seconds, if a long low tone is played each second, then the motor stator is likely to be faulty and should be replaced (refer section 9.18).

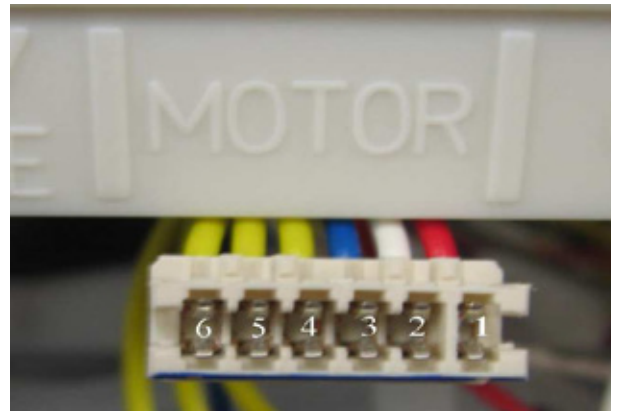

*Controller Harness P201*

***Fault code E2 - Sub Code 03 - Motor Not Drawing Enough Current***

1. Check the harness connections at the motor and controller for signs of any water damage, corrosion or arcing. Replace if damaged.
2. Check the hall sensor (RPS) is correctly located and is held firmly in place on the motor stator and that the wiring harness is connected to it.
3. Check the stator windings to ensure correct resistances, this can be done on harness P201 at the controller, check between pin 1 & 2, 2 & 3, 1 & 3 the reading should be 8.0 ohms per winding, 16 ohms phase to phase. (refer section 9 for more detail.)
4. Check the motor rotor is correctly fitted to the motor housing.
5. Replace the motor rotor, place the product in "HO" mode (refer pages 30 & 31), run the wash motor (P1) for at least 10 seconds. If a long low tone is played each second, then the current draw is outside of the allowable limit. In this case replace the controller



*Corrosion Damage Example*

**NOTE:** When running the wash motor in P1 direction, the tub must be closed to ensure the prism circuit is closed.

### 7.1.5 Fault Code E3 - Over Temperature Fault

1. Check the temperature of the incoming water supply, for all markets, except the USA, cold water is recommended. If connected to the hot water supply, ensure the incoming water temperature is below 140°F (60°C).
2. Check the resistance of the temperature sensor (pins 1 & 2 of the P101 harness connector). It should be approximately 10k  $\Omega$  at 25°C (refer page 57)
3. Check the heater plate resistance to ensure it is correct for the market on P101 pin 6 and the neutral pin on the power plug.  
50  $\Omega$  (NZ,AU,EU,UK)  
24  $\Omega$  (US,CA,TW)
4. Replace the heater plate. Fill the tub with approx 2.5L (0.7 gal) of water and turn the product on. If the product starts to heat without the heater plate being enabled, then this would indicate a fault with the controller.
5. If the E3 fault still occurs, then replace the controller.

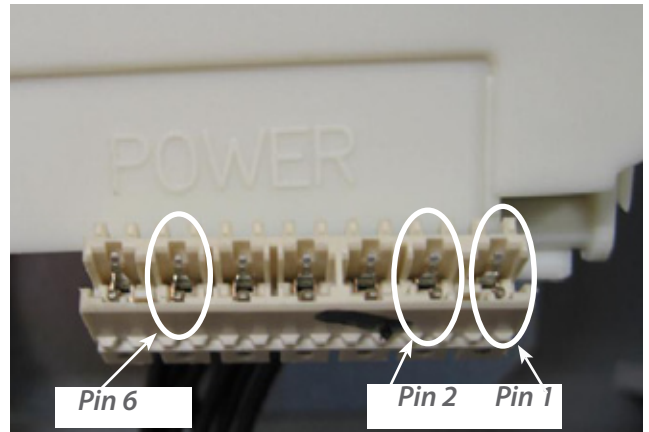

### 7.1.6 Fault Code E4 - Heater Plate Fault

1. Check the harness connections at the controller and heater plate for signs of water damage, corrosion or arcing. Replace if damaged.
2. Check the resistance of the element track and dropper resistor.
3. Heater track P101 pin 6 and the neutral pin on the power plug.
4. Dropper resistor harness P101 pins 4 & 5 (Refer page 57)

Component	NZ,AU,UK,EU	US,CA,TW
Heater Track	50	24
Dropper Resistor	98	24

5. If either of these values are outside of their specification replace the heater plate.
6. If the E4 fault still occurs then replace the controller.

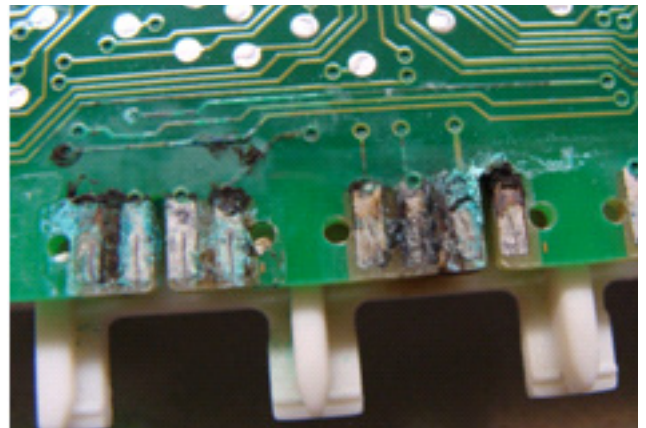

#### Fault Code E4 - Sub Code 01 - Element Timed Out

1. Check element track, if OK then replace the controller.

#### Fault Code E4 - Sub Code 02 - Dropper Resistor Open Circuit

1. Check dropper resistor, if open circuit then replace the element assembly ( refer section 9.18)

**NOTE: For more detailed component testing, refer to page 57.**



**Fault Code E5 - Lid Fault**

1. Check for any obstructions within the tub, especially around the flange area where the lid seals.
2. Check customer has not used tall utensils that may have caused the lid to jam.
3. Check the lid system for any physical damage or disconnection of yoke , clip or wiring.
4. Check wiring harness connections at the component and at the controller for any signs of water damage, corrosion or arcing. Replace if damaged.
5. Check the resistance of each lid actuator at the controller, only replace an actuator if it is open or short circuit.
6. Chassis harness P205 pin pair 6 & 7, 8 & 9. Run the lid actuators in diagnostics ( refer p30 & 31) to ensure they move the lid in both upwards and downwards directions. This can be down with the tub removed or pulled slightly forward on the rails.
7. If the fault still occurs, check the sub code fault and, if problem persists, replace the controller.

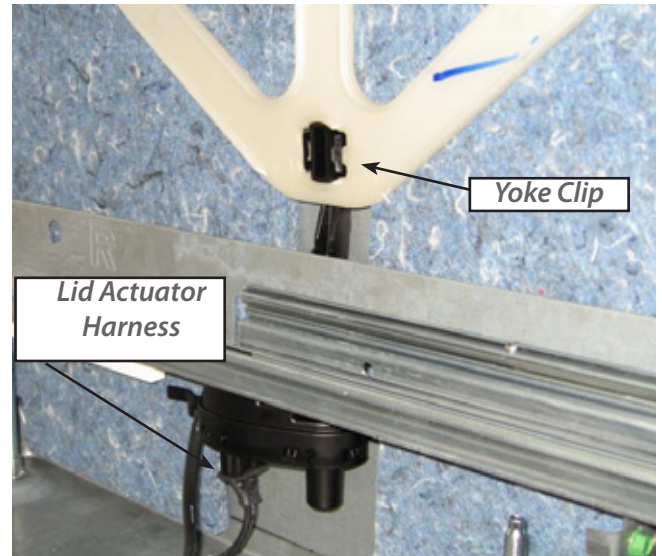
**Fault Code E5 - Sub Code 01 - Not Starting**

1. Check harness connection at controller for signs of water damage, corrosion or arcing. Replace if damaged.
2. Check actuator resistance (open or short circuit), if OK then replace controller.

**Fault Code E5 - Sub Code 02 - No Current**

1. Check harness connection at controller for signs of water damage, corrosion or arcing. Replace if damaged.
2. Check actuator resistance, if open circuit, replace lid actuator.
3. If actuator OK, then replace controller.

**Fault Code E5 - Sub Code 04 - Not Stalling**

1. Check harness connection at controller for signs of water damage, corrosion or arcing. Replace if damaged.
2. Replace the controller.

**Fault Code E6 -Fan Fault**

1. Check the harness connections on the component and the controller for signs of any water damage, corrosion or arcing. Replace if damaged.
2. Check that the harness is securely connected at the controller.
3. Run the drying fan (dF) in "HO" mode (refer p30 & 31) for at least 30 seconds. The fan should push air through the vent. The flap within the fan housing should open. To check if the flap is free to move, remove the locking tab, remove fan and the flap can be pushed upwards.
4. While running the fan is HO mode, if a long low tone is played at 1 second intervals this indicates the fan is faulty, replace the fan.
5. Once the new fan is replaced, follow step 3 and run the fan in HO mode for 30 seconds, there should be no tone played.
6. If the fan fault continues, replace the controller.

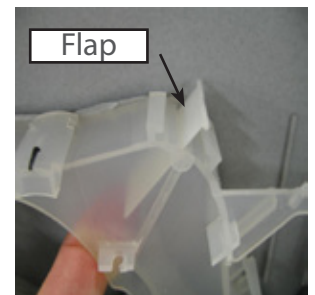
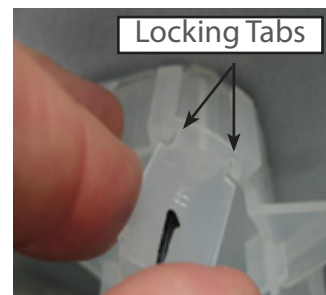
**Fault Code E6 - Sub Code 02 - Under Current**

1. Check the harness connections at the controller
2. Run the new drying fan (dF) in "HO" mode (refer p30 & 31) for at least 30 seconds. While running the fan in HO mode, if a long low tone is played at 1 second intervals this indicates the fan is faulty.
3. If the fault continues, replace the controller.

**Fault Code E6 - Sub Code 03 - Over Current**

1. Run the new drying fan (dF) in "HO" mode (refer p30 & 31) for at least 30 seconds. While running the fan in HO mode, if a long low tone is played at 1 second intervals this indicates the fan is faulty.
2. If the fault continues, replace the controller.

### *Fault Code E7 - Detergent Diverter Valve*

1. Check the harness connections on the detergent diverter valve and at the controller (P204 refer p56) for signs of any water damage, corrosion or arcing. Replace if damaged.
2. Ensure the harness is securely connected at the controller and component.
3. Check the detergent diverter valve in diagnostic "HO" mode ( refer p30 & 31) , if after 10 seconds a long low tone is played and repeats every second, then the detergent diverter solenoid is faulty and needs to be replaced.
4. Check the resistance of the coil on harness P204, on pin pair 3 & 4, the reading should 65 +/- 10 Ohm.
5. Once solenoid is replaced, repeat step 3 to ensure new solenoid is OK.
6. If fault still occurs, replace the controller.

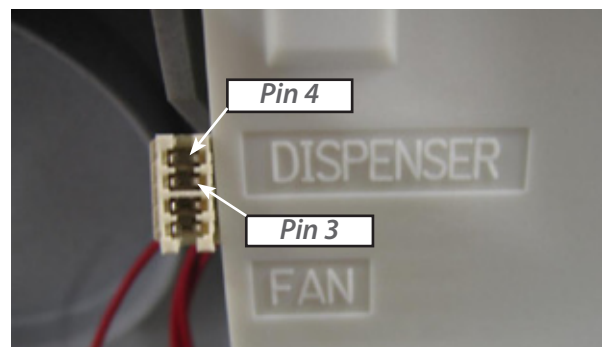
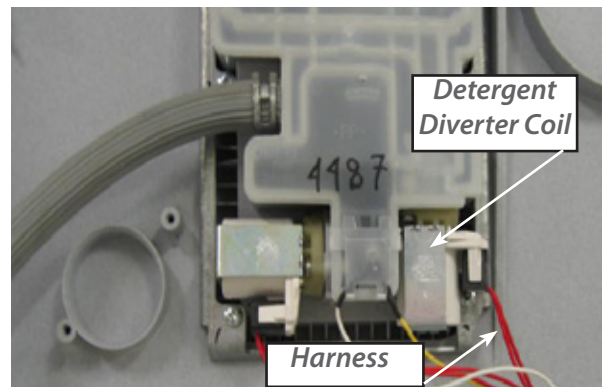

### *Fault Code E7 - Sub Code 02 - Under Current*

1. Check the harness connection at both the controller and solenoid.
2. Check the detergent diverter valve in diagnostic "HO" mode ( refer p30 & 31). If after 10 seconds a long low tone is played and repeats every second, then the detergent diverter solenoid is faulty and needs to be replaced.
3. Check the resistance of the coil on harness P204, on pin pair 3 & 4, the reading should 65 +/- 10 Ohm. Replace if open circuit.
4. If the fault still occurs, replace the controller.

### *Fault Code E7 - Sub Code 03 - Over Current*

1. Check the harness connections at both the controller and solenoid.
2. Check the detergent diverter valve in diagnostic "HO" mode ( refer p30 & 31). If after 10 seconds a long low tone is played and repeats every second, then the detergent diverter solenoid is faulty and needs to be replaced.
3. Check the resistance of the coil on harness P204, on pin pair 3 & 4, the reading should 65 +/- 10 Ohm. Replace if short circuit.
4. If the fault still occurs, replace the controller.

**Fault Code E8 - Solenoid Fault**

1. Check the harness connections at each solenoid coil and at the controller (refer p57) for signs of any water damage, corrosion or arcing.
2. Check the resistance of each coil and replace if they fall outside of their indicated range.
3. Run each solenoid individually in diagnostic hardware output mode (HO) (refer page 30 & 31). A long low tone indicates incorrect current is being drawn. Replace any solenoid which causes this tone to occur.
4. If the fault still occurs, replace the controller.

<i>Component</i>	<i>Harness Connector</i>	<i>Pin Pair</i>	<i>Resistance value</i>
<i>inlet valve</i>	<i>P205</i>	<i>10 &amp; 11</i>	<i>65 +/- 10 Ohm</i>
<i>rinse aid pump</i>	<i>P204</i>	<i>1 &amp; 2</i>	<i>65 +/- 10 Ohm</i>
<i>detergent diverter</i>	<i>P204</i>	<i>3 &amp; 4</i>	<i>65 +/- 10 Ohm</i>
<i>water softener bypass valve (if fitted)</i>	<i>P202</i>	<i>1 &amp; 2</i>	<i>65 +/- 10 Ohm</i>
<i>Water softener brine pump (if fitted)</i>	<i>P202</i>	<i>3 &amp; 4</i>	<i>65 +/- 10 Ohm</i>

**Fault Code E8 - Sub Code 02 - Under Current**

1. Check the harness connections at both the component and at the controller.
2. Check resistance of coil to see if open circuit, replace solenoid if open circuit.
3. If the fault continues, replace the controller.
4. Test all solenoid coils in diagnostic HO mode.

**Fault Code E8 - Sub Code 03 - Over Current**

1. Check the harness connections at both the component and at the controller.
2. Check resistance of coil to see if short circuit, replace solenoid if short circuit.
3. If the fault continues, replace the controller.



### *Fault Code E9 - Microcontroller Fault*

There are 4 sub codes which relate to this fault code:

#### *Fault Code E9 - Sub Code 04 - ADC Error*

1. If the product is an integrated or flat door model, replace the badge isolator first, run a fast test cycle in diagnostics to determine if the problem still occurs. (refer p30-32).
2. If the fault still occurs, or the product is a pre finished or wireless badge model, replace the controller.

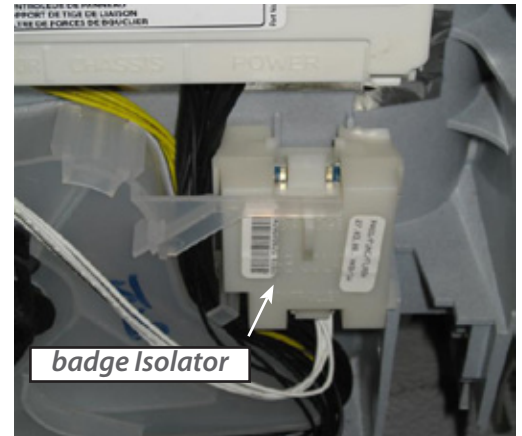

**Note:** The badge isolator and wireless receiver use the same outer casing, and can easily be mixed up. Ensure you order the correct part for the corresponding product. The wireless badge has the part number showing on the single label.



#### *Fault Code E9 - Sub Code 05 - PSU Overvoltge*

1. Check all the harness connections at the controller for signs of any water damage, corrosion or arcing. Replace if damaged.
2. Run the detergent diverter valve by itself in diagnostic hardware output mode (HO) (refer p30 & 31). If after 5 seconds a long low tone is played and repeated each second, then the detergent diverter solenoid is drawing an incorrect current level and should be replaced.
3. If the fault still occurs then replace the controller.

#### *Fault Code E9 - Sub Code 06 - Software Reset*

1. Replace the controller.

#### *Fault Code E9 - Sub Code 07 - Forced PSU Shutdown*

1. Inspect all the component terminals and connectors for damage caused by corrosion or arcing. Replace harness if necessary.
2. Replace **both** the controller and mains filter board.
3. In diagnostic hardware output mode (HO) run each component individually and check for proper component operation, run a fast test cycle ( refer p29-31) and if any secondary fault occurs, follow the steps in this maual for that fault code.

### *Fault Code EC - Communications Fault*

Check the harness connections between the mains filter board and both controllers for signs of any water damage, corrosion or arcing. Replace if damaged.

If the problem persists replace the mains filter board

If the problem persists replace the top controller

If the problem persists replace the bottom controller.

## **7.2 Completing a Service**

At the end of every service the following procedure should be followed to ensure the fault has been repaired, and the product is fully operational for the customer.

After replacing any component, run each hardware output individually for at least 10 seconds in diagnostic hardware output mode (HO) refer to p30 & 31 for the list of output devices.

If a long low tone is played at 1 second intervals, then the device being tested is faulty and should be replaced.

Running the outputs in the following order is recommended:

1. Fill Valve
2. Lid Actuators
3. Solenoids
4. Rinse aid pump
5. Detergent diverter
6. Water softener bypass valve (if fitted)
7. Water softener brine pump (if fitted)
8. Wash motor
  - Do not run the wash pump with no water or lid not sealed on the tub. The wash pump will not operate with the tub in open position.
9. Drain pump
10. Heater plate
  - Do not operate the heater plate without water present covering the heater plate. It is recommended to have at least 2.5 l (.6 gal) of water in the tub.
11. Run a fast test cycle.

### **Note:**

When operating the rinse aid pump in diagnostics, rinse aid will be dispensed. If the testing is performed several times, rinse aid can build up inside the tub, and foaming may occur. It is recommended that any excess rinse aid should be removed from the tub before completing any service.

8.2 Power Distribution Concept

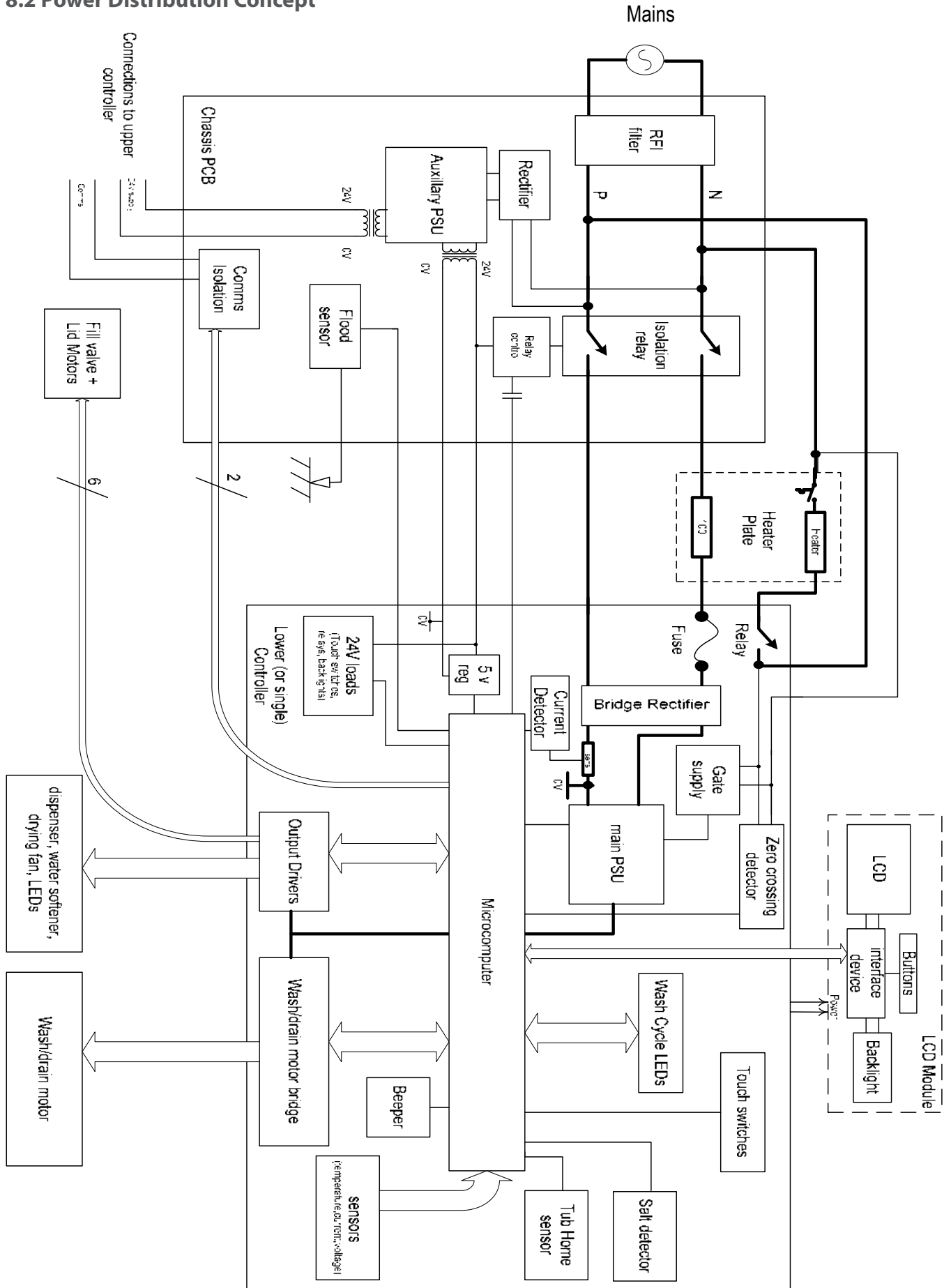



## 9 SERVICE PROCEDURES

**Caution:** Due to the use of electronic switch mode power supply, all internal components, regardless of supply voltage, should be treated as live to earth (i.e. equal to the mains supply voltage) when the power is supplied to the DishDrawer.

### 9.1 Component Testing

DEVICE	CONNECTOR	PIN PAIR	DESCRIPTION
Fill Valve	P205	10 & 11	65 +/- 10 Ohms
Lid Motor	P205	6 & 7	check if open or short circuit
Lid Motor	P205	8 & 9	check if open or short circuit
Rinse aid pump	P204	1 & 2	65 +/- 10 Ohms
Detergent diverter	P204	3 & 4	65 +/- 10 Ohms
Fan	P203	1 & 2	check if open or short circuit
Water softener bypass valve	P202	1 & 2	65 +/- 10 Ohms
Water softener brine pump	P202	3 & 4	65 +/- 10 Ohms
Temperature sensor	P101	1 & 2	12000 Ohms @ 20°C (68°F) 8300 Ohms @ 30°C (86°F) 3000 Ohms @ 60°C (140°F)
Motor phases	P201	1 & 2 2 & 3 1 & 3	8.0 +/- 5 ohms (per winding) 16 Ohms phase to phase from the controller connection.
Dropper resistor	P101	4 & 5	98 ohm +/- 7 (NZ, AU, EU, UK) 24 ohm +/- 3 (US, CA, TW)
Element	P101 & Power Plug	6 & neutral on plug	50 ohm +/- 4 (NZ, AU, EU, UK) 24 ohm +/- 3 (US,CA,TW)

**Note:** Pins are counted right to left on connector harnesses P101 Power, P205 Chassis, P201 Motor, P303 LCD/Badge and P302 Comms.

Connectors on harnesses P202 water softener (if fitted), P203 Fan & P204 Dispenser, pin 1 is at the bottom of the connector, refer to illustration below for harness connections.

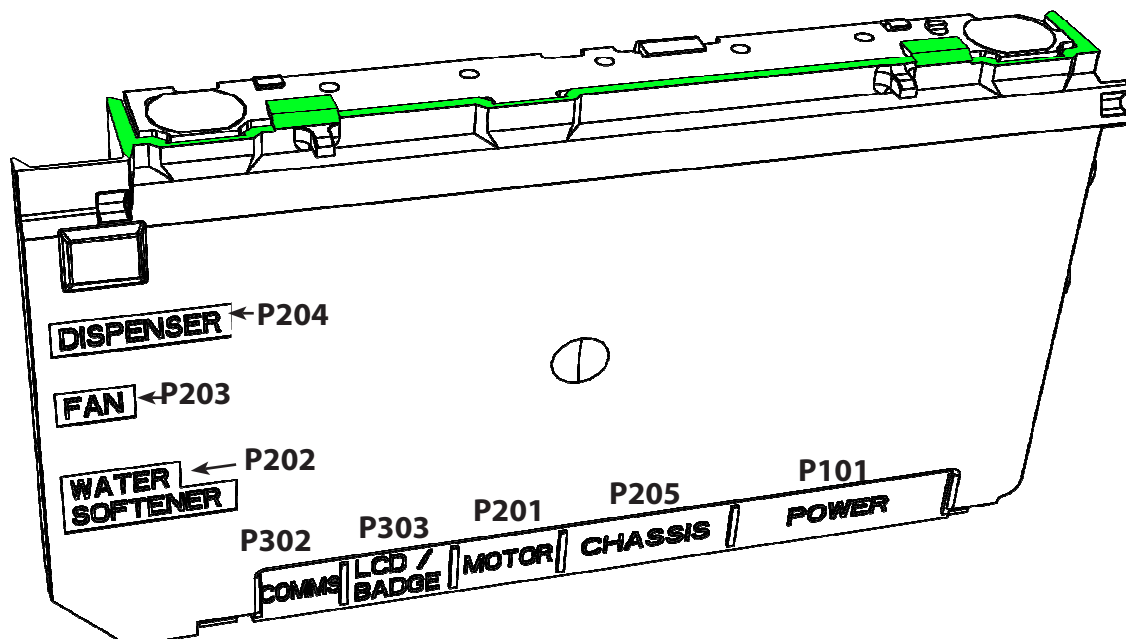



## 9.2 Drawer Front

1. Open the drawer
2. Locate the drawer pins on either side of the tub.
3. If the pins cannot be accessed due to being close to a wall, remove the tub from the slides first (refer p59, section 9.6).
4. Use pliers to pull on the pin and remove it from the side of the tub.
5. Support the drawer front with your hand while doing this to prevent it dropping onto the floor.
6. Pull the drawer front down to free it from the handle and the top locating slots in the tub.
7. Remove the earth wire from the tab on the drawer front. If it is an integrated or flat door model, it will be necessary to unplug the integrated badge from the badge isolator.
8. Refit in reverse manner, ensuring the earth wire is reconnected, drawer slides are fully forward and the pins secure through the hooks on the front end of the slides.

**NOTE:** When reinserting the pins, ensure that the dividing web is vertical as shown.



## 9.3 Handle and LCD Display

1. Remove the drawer front (refer section 9.2)
2. Disconnect the LCD wire harness from the controller.
3. The handle slides onto the flange at the top of the tub. Push the handle from the right to the left to release it.
4. The handle may now be lifted clear by pulling it forwards.
5. The LCD display is held in place by a wedge with a spring tab. Without lifting the tab, slide the wedge downwards using your finger tips to release, the LCD assembly can now be removed.
6. The wiring harness can now be unplugged from the LCD circuit board.
7. Refit in reverse manner.

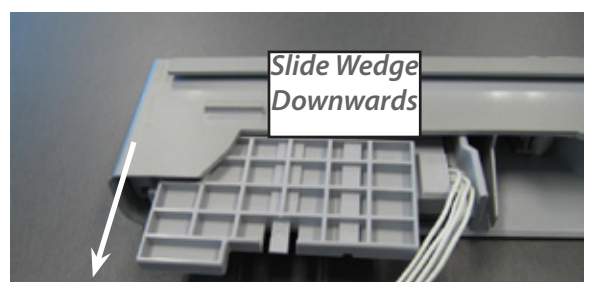
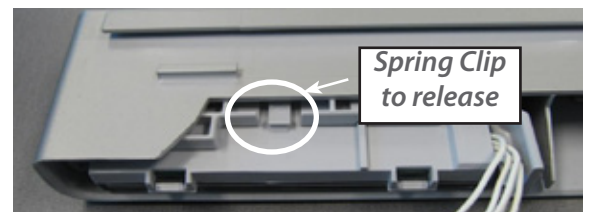





### 9.4 Toe Kick Removal

1. Partially open the bottom drawer.
2. Loosen the right and left hand toe kick screws.
3. Slide the toe kick towards the front of the tub until it comes off the mounting rails.
4. Refit in reverse manner.

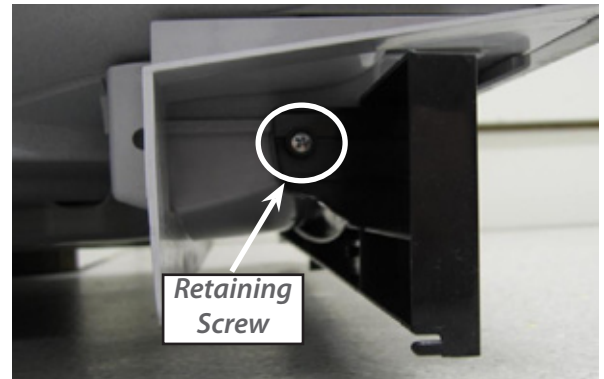

### 9.5 Lower Tub Cowling

1. Remove the lower drawer front (refer section 9.2)
2. Remove the toe kick (refer section 9.4)
3. Release the centre clip as shown and slide the cowling forward.
4. Refit in reverse manner.

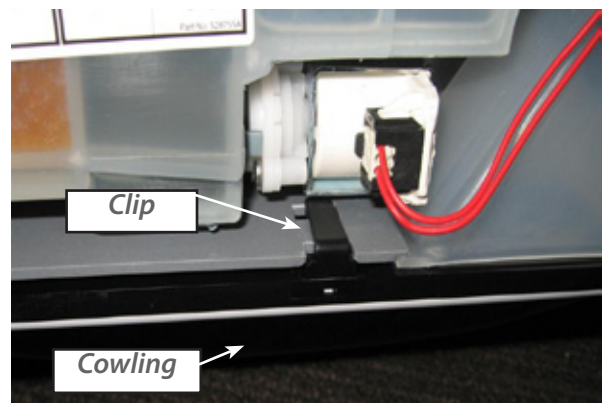

### 9.6 Tub Removal

1. Open the drawer.
2. Removing the drawer front (refer section 9.2) makes it easier to slide the tub rails back (optional).
3. Top tub : depress the right hand tub clip and push it back about 30mm. Repeat for the left hand side.
4. Bottom tub: remove the toe kick (refer section 9.4) and lower tub cowling (refer section 9.5), both optional.
5. If the cowling has not been removed, then the tub clips need to be pushed back about 130mm so the slide clears the cowling when the tub is lifted.
6. Lift the tub off the slides and push the runners back into the product.
7. Releasing the wire from the centre clip on the link assembly allows the tub to be moved further from the chassis (optional).
8. If the tub is being turned over for servicing, rotate it counter clockwise, remembering to remove the baskets first. Removing the handle will prevent it from being damaged.
9. Refit in reverse manner.

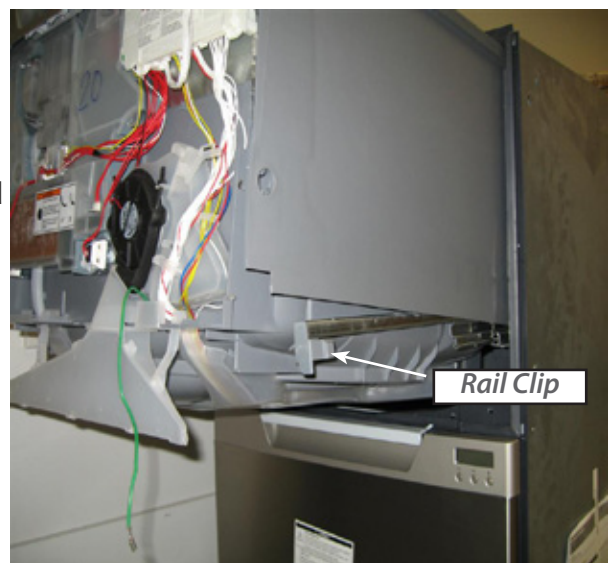



### 9.7 Drying Duct - Top Tub Only

1. Open the drawer and remove the drawer front (refer section 9.2).
2. Use long nose pliers to gently release the plastic clips while pulling the duct downwards.
3. Refit in reverse manner, and ensure clips locate correctly.

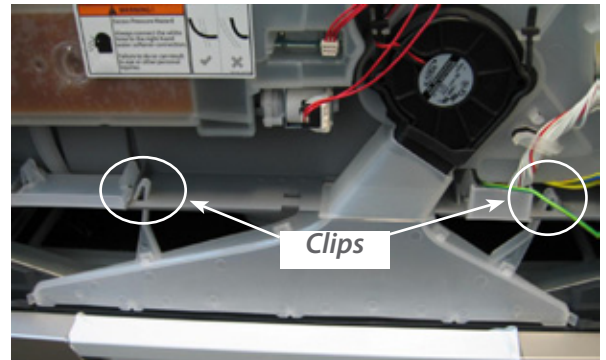

### 9.8 Drying Fan and Flap Valve

1. Remove the drawer front (refer section 9.2).
2. With a small bladed screwdriver, carefully release the small plastic clips holding the rinse aid indication LED in place in the detergent dispenser and remove the LED.
3. Release the rubber tabs securing the fan.
4. Disconnect the wire harness from the electronic controller.
5. The drying fan will now come free.
6. Refit in reverse manner.
- 7.

**Note:** The fan housing flapper can be replaced by removing the cover and lifting the flapper out the housing.

To remove the cover, use a small screwdriver to depress the 2 clips at the rear, and slide it forward to release.

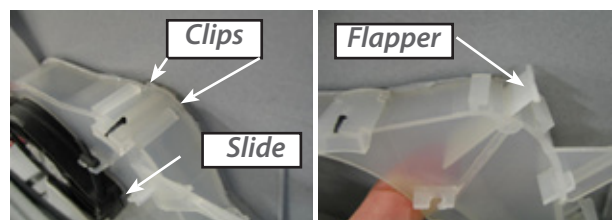
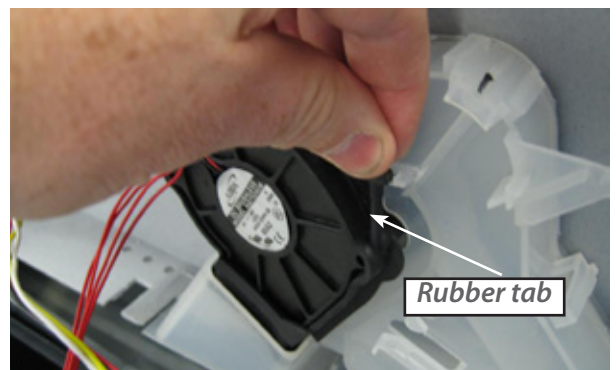
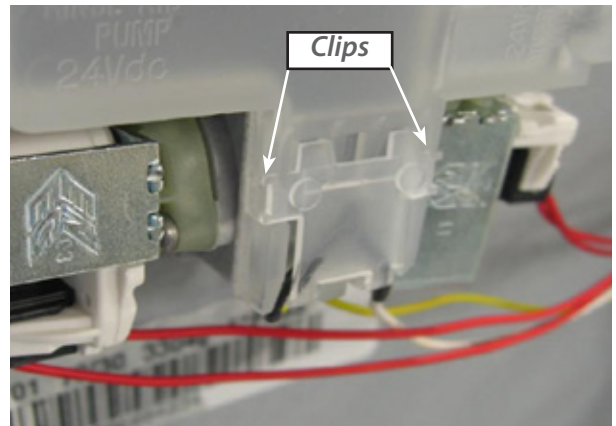





### 9.9 Detergent Dispenser

1. Remove the drawer front (refer section 9.2)
  2. Disconnect the two wiring lock connections from the dispenser coils.
- NOTE:** Push back the locking tabs to allow the connectors to release.
3. With a small bladed screwdriver, carefully release the small plastic clips holding the rinse aid indication LED in place and remove the LED.
  4. Use pliers to release the clamp and remove the fill hose from the dispenser.
  5. While holding the dispenser, unscrew the six torx drive screws securing the two brackets to the dispenser.
  6. The dispenser can not be removed from inside the tub.
  7. To open the dispenser door fully, first open the door using the release catch, then squeeze the top sides of the door together. This will release the door to the fully open position. This can be done with the dispenser in place.
  8. Refit in the reverse manner ensuring the dispenser gasket is located correctly.

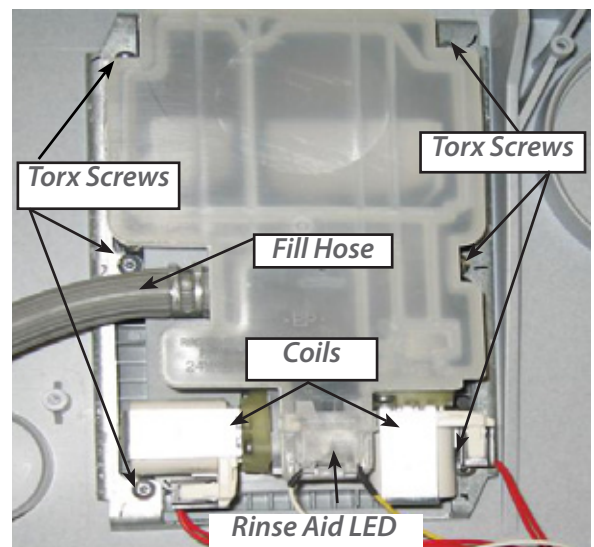
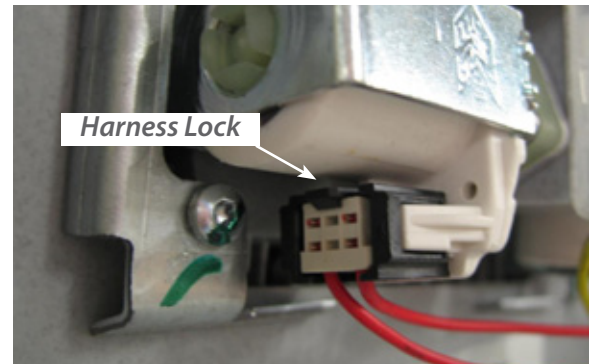

### 9.10 Electronic Controller

1. Remove the drawer front (refer section 9.2) and optionally the handle can be removed for ease of servicing. (refer section 9.3).
2. Disconnect the wiring connectors to the controller.
3. Use a flat blade screwdriver to release the clip on the right hand side of the controller by firmly pushing it towards the tub. Do not lever against the clip, as there is a chance of breaking it.
4. The bottom of the controller can now be lifted out to an angle of 45°, at which point the top of the controller will come free from the tub.
5. Refit in reverse manner, ensuring the controller is located correctly in behind the tub flange at the top.

**NOTE:** When servicing a single integrated wireless product, it is important to only fit a spare part controller as a replacement, as the product will detect the wireless receiver and set the correct wash profile. Do not fit a controller that has previously been installed in an other product.

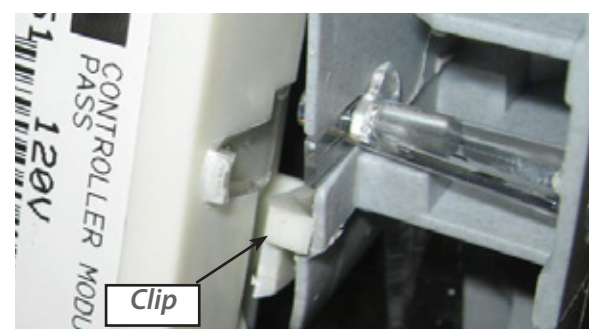



### 9.11 Filter Plate

1. Remove the cutlery basket and rack from the tub.
2. Remove the drain filter assembly.
3. Rotate the filter plate locknut anti-clockwise to release the filter plate from the motor rotor assembly.
4. Lift the filter plate clear.
5. Refit in reverse manner, ensure the 3 legs are locked correctly to the motor rotor and the o-ring on top of the motor rotor is in place.

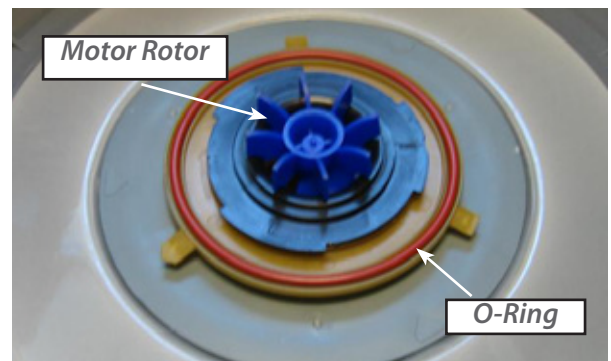
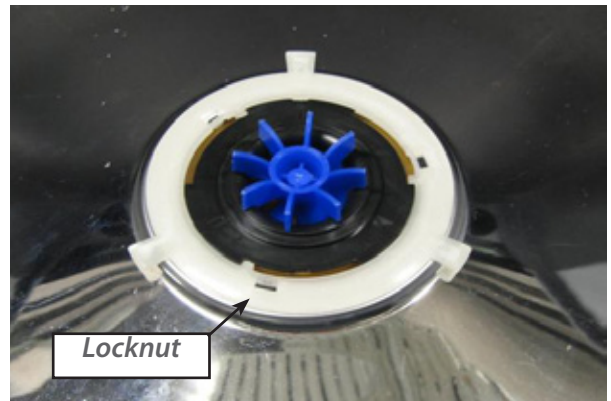

### 9.12 Motor Rotor

1. Remove the filter plate (refer section 9.11)
2. Slightly lift the motor rotor lock ring at the pointer to disengage the lock tab under the chimney, then rotate the motor rotor anti-clockwise to release it from the motor housing and lift out.
3. The rotor assembly is not serviceable and if damaged should be replaced.
4. Refit in reverse manner, taking care to align the legs on the rotor with the slots in the motor housing. The rotor can only be placed in one position. The short leg goes into the middle slot on the housing.

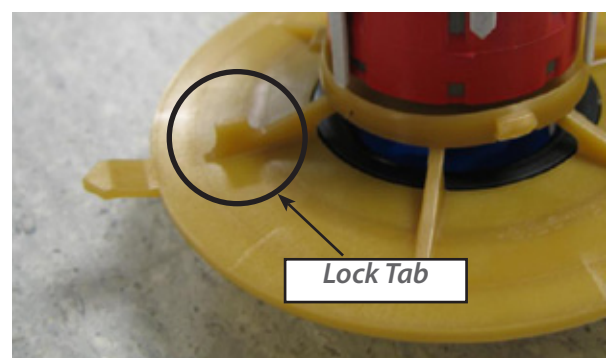
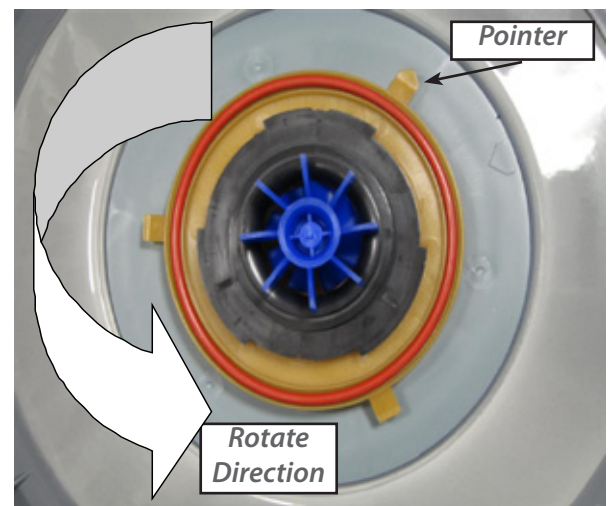



### 9.13 Water Softener (if fitted)

1. Remove the drawer front (refer Section 9.2).
2. Disconnect the wiring loom connections to the water softener diverter valve, brine pump and salt level detector, and remove the dispenser wiring loom connection to the electronic controller.
3. Use a flat blade screwdriver to open the salt level indicator LED cover, and remove the LED from the water softener.
4. Unclip the fill hose to strainer and remove the dispenser hose from the water softener.
5. Remove the four T10 torx drive screws securing the water softener to the tub. The water softener can now be removed from the product.
6. To refit, place the overflow 'O' ring on the water softener and lubricate the tub overflow with a water-soluble lubricant e.g. Glycerol or similar.
7. Place the salt tank 'O' ring in the tub. Lubricate the salt tank flange on the water softener. Pass the dispenser wiring loom through the water softener and plug it into the electronic controller.
8. Place the water softener in the tub and apply enough pressure to seat the 'O' rings.
9. The overflow should sit almost flush with the inside of the tub. The salt tank should be recessed by approx 1mm (1/32 inch) from the inside of the tub
10. Refit the screws, strainer, hoses, harness connectors and LED.

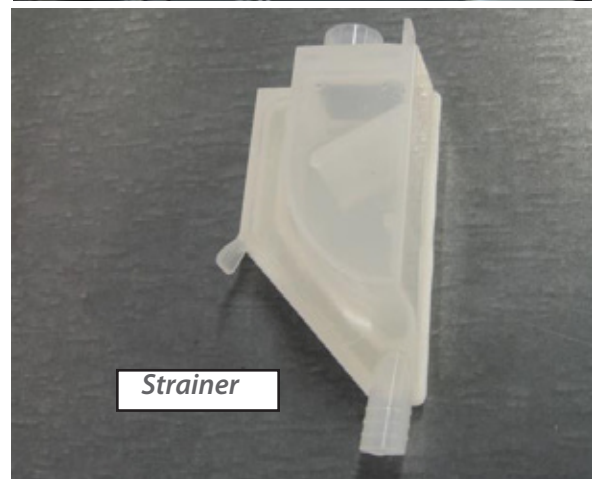
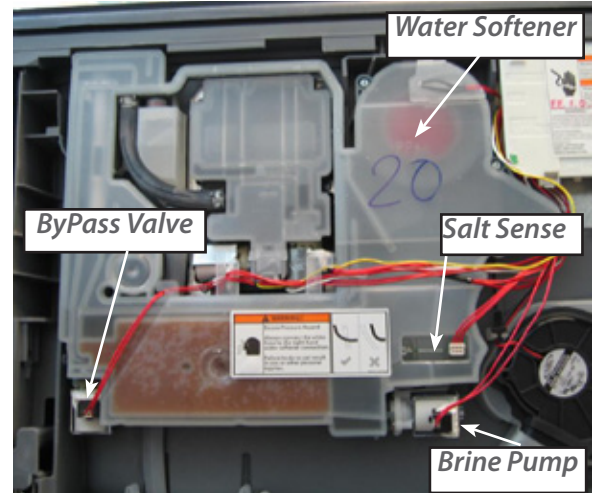

### 9.14 Strainer (if fitted)

1. Remove the water softener hose from the detergent dispenser spigot.
2. Place screwdriver under clip and use lever action to disengage the clip.
3. When clip is disengaged, the strainer can be pushed down off the water softener spigot.
4. After removing the hose clamp, the strainer can now be removed from the DishDrawer.
5. Fit new strainer & position hose clamp. Manoeuvre strainer into place.
6. Slide into spigot using a force applied in an upwards movement. Lock into place, and ensure correct fitting.
7. Fit dispenser hose to detergent dispenser spigot.

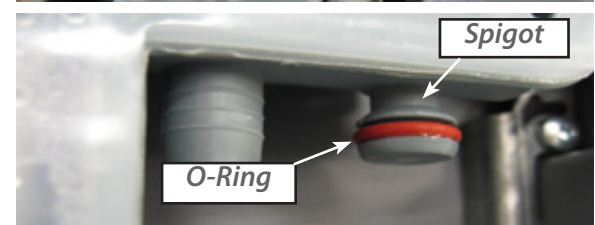
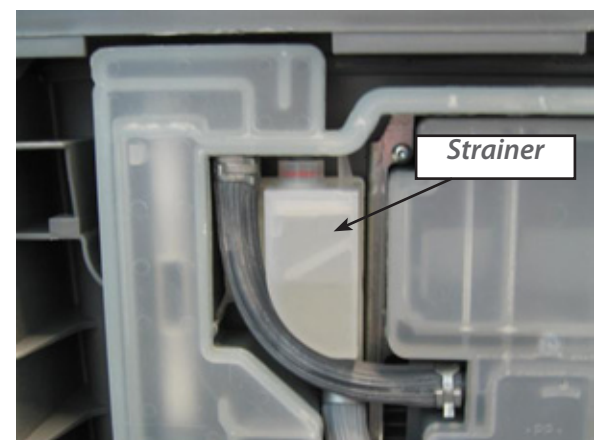





### 9.15 Wiring Cover

1. Remove the drawer front (refer section 9.2)
2. With the tub in the open position, carefully release the four wiring cover clips, two on each side, from under the front lower section of the tub. Take care not to damage them.
3. Release the four clips on the underside of the tub that attach the wiring cover to the motor assembly outer lock nut.
4. Pull the tub fully open and lift it up at the front (this makes it easier to remove the wiring cover from the rear of the tub).
5. The wiring cover may now be carefully moved forward and downward to release it from the rear of the tub.
6. To reassemble, first ensure that the wiring harness, drain hoses and fill hose are located in their correct positions.
7. Then refit in reverse manner.

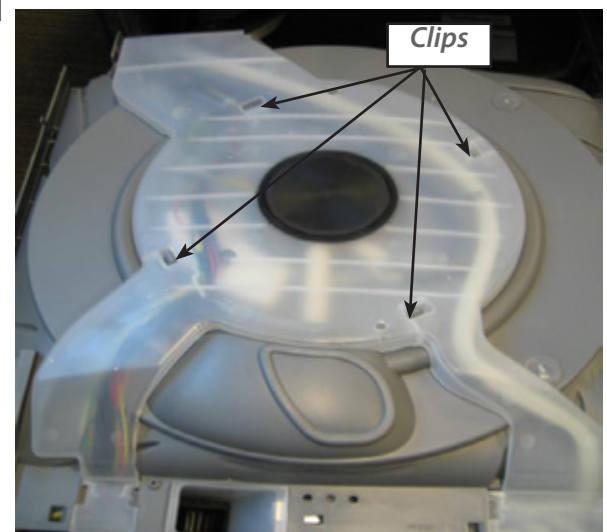
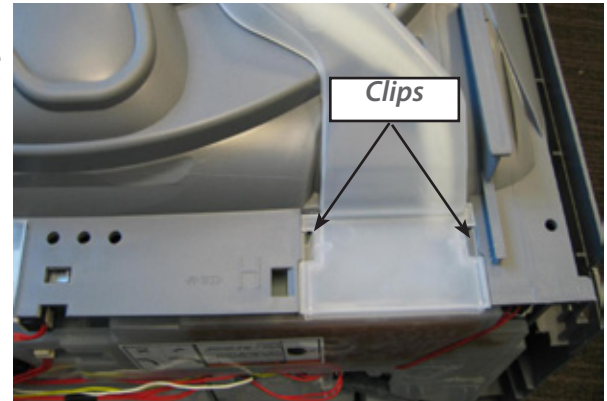

**Note:** It may be easier to remove the tub and rotate it anticlockwise to remove the wire cover (optional) refer section 9.6.

### 9.16 Tub Disconnection

1. Remove the drawer front (refer 9.2)
2. Remove the wiring cover (refer 9.15)
3. Disconnect the fill hose from the dispenser (water may drip) refer section 9.9.
4. Disconnect the chassis harness plug from the controller.
5. Remove the wiring cover and the element connector cover.
6. Disconnect the element harness plug and earth wire from the element plate.
7. Unclip the drain hose cuff from the motor assembly, taking care not to misplace the non-return flap valve.
8. Unclip the drain hose, fill hose and the wiring loom from the under side of the tub.
9. Remove the tub.
10. Refit in reverse manner.

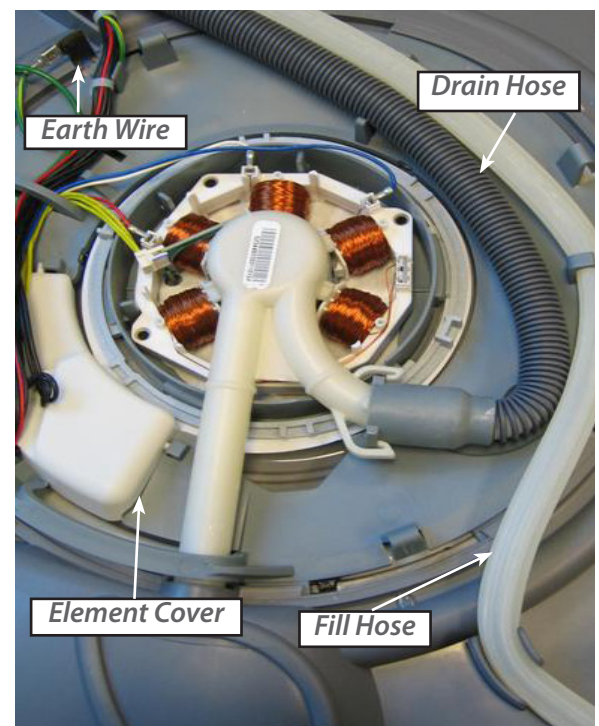

**NOTE:** When replacing a fill hose, drain hose or wiring harness, transfer the link support clip markings from the old parts to the new.



### 9.17 Hall Sensor

1. Remove the wiring cover (refer section 9.15)
2. Unplug the wiring connection from the hall sensor
3. Gently press the hall sensor locking tab in the direction shown and lift the hall sensor out.
4. Refit in reverse manner and ensure the hall sensor is properly clipped in.

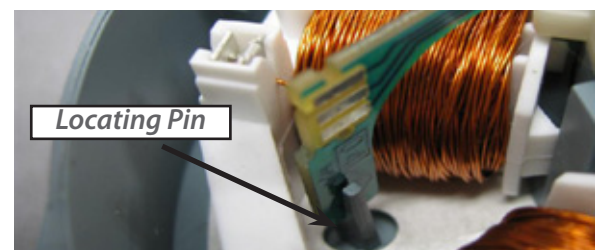
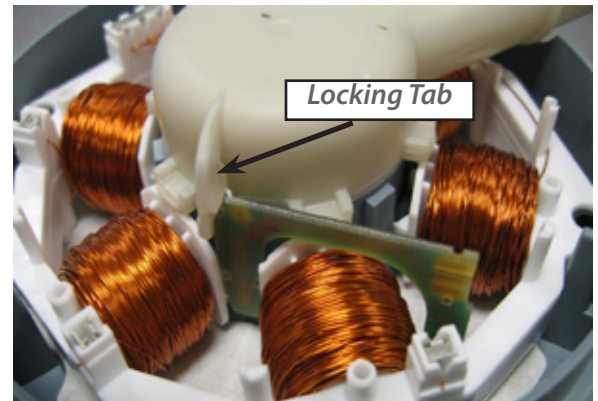

### 9.18 Heater Plate and Motor Assembly

1. Remove the drawer front (refer section 9.2), baskets, filter plate (refer section 9.11) and rotor assembly (refer section 9.12).
2. Remove the tub and rotate anti-clockwise (refer section 9.6)
3. Remove the wiring cover (refer section 9.15)
4. Remove the element connector cover and element wiring connector.
5. Remove the drain hose and heater plate earth wire.
6. While lifting the locking tab on the outer locknut, rotate the outer locknut anti-clockwise until it comes free of the tub tabs, then remove it. Take care not to damage any motor wiring as the locknut is turned, or the flap valve slot when the locknut is removed.
7. Lift the rear of the heater plate and motor assembly clear of the tub and slide the drain spigot out of the tub drain area.
8. Remove the inner locknut and motor shim to release the motor assembly from the heater plate. Take care with the seals between the motor assembly and the heater plate, and the heater plate and tub. Their seals and their corresponding sealing surfaces must be clean and the seals correctly placed during reassembly.
9. Check both the drain hose o-ring and drain spigot o-ring for damage and replace them if necessary. Lubricate before assembly and replace the flap valve.
10. Reassemble in reverse manner, ensuring all the locking ring tabs are engaged.

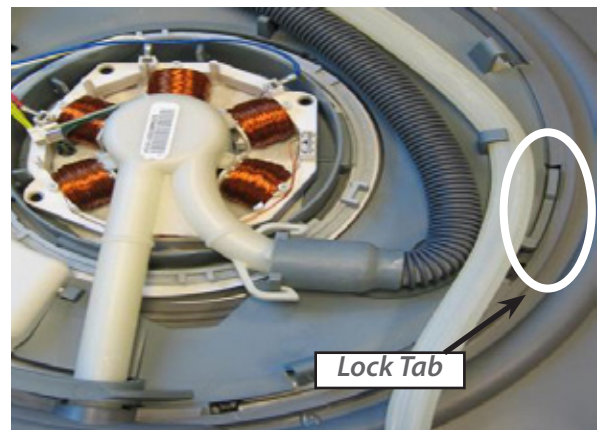





### 9.19 Lid

1. Remove the tub as per section 9.6.
2. On the right hand side of the lid, insert a flat blade screwdriver into the yoke slots between the lid flange and the yoke.
3. Twist the screwdriver while pulling down on the lid to disengage the clip. Repeat for each clip on both yokes.

**NOTE:** Do not pull down on the lid seal.

4. Pull the lid down 10mm (3/8") on one side. Pull the opposite side of the lid down until it is clear of the yoke. The high side of the lid can then be pulled to the bottom of the yoke slots. The lid is now free to be removed from the chassis on an angle as shown.

**NOTE:** For more detail on lid removal, click on the link in the following page to watch the short video clip on lid removal.

5. To reassemble the lid, angle the lid into the chassis, ensure the lid is the correct way round, the words "FRONT" are printed on the top of the lid and should be at the front of the product.
6. Engage the T-Rib on the high side of the lid into the bottom of the yoke slots. Swing the opposite side of the lid past the yoke until it sits into the bottom of the yoke slots.

**NOTE:** The T-Ribs make the lid wider, so some force is required to push past the yoke.

7. Clip the lid into place. Start by pushing one corner of the lid up until it clicks. Next clip the diagonal corner up. The lid is now assembled and should look like the image.

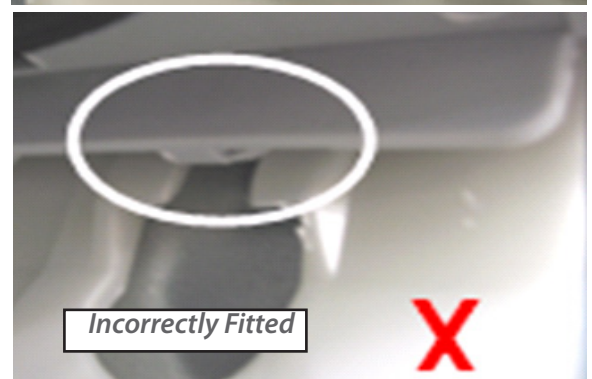
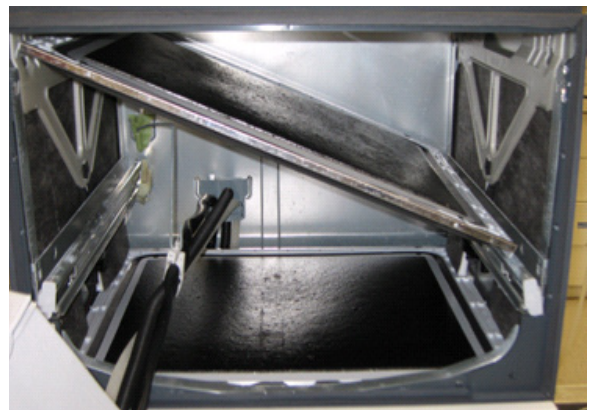
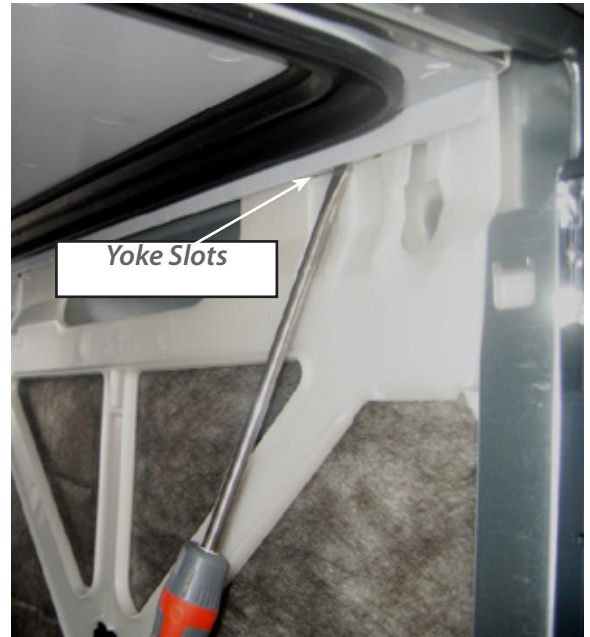



### 9.20 Yoke

1. Remove the lid, refer section 9.19.
  2. Release the lid actuator from the bottom of the yoke by pushing with your thumb against one of the locking tabs.
- NOTE:** In tall tub models use an adaptor between the yoke and the lid actuator.
3. Slide the front of the yoke downwards at an angle until it moves out of the track in the rear of the trim, and is clear of the chassis flange as shown.
  4. Refit in reverse manner taking care that the yoke is the correct way round.

**NOTE:** There are both left hand and right hand yokes. Do not bend the yoke when refitting it. Locate the rear end below the chassis tab at the rear of the chassis first, then slide the front up in behind the trim to ensure the front yoke peg locates correctly in the track behind it.

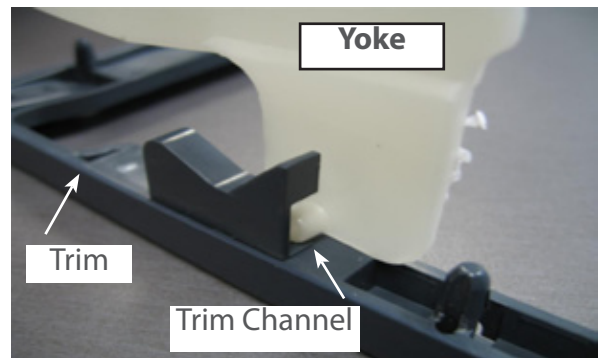
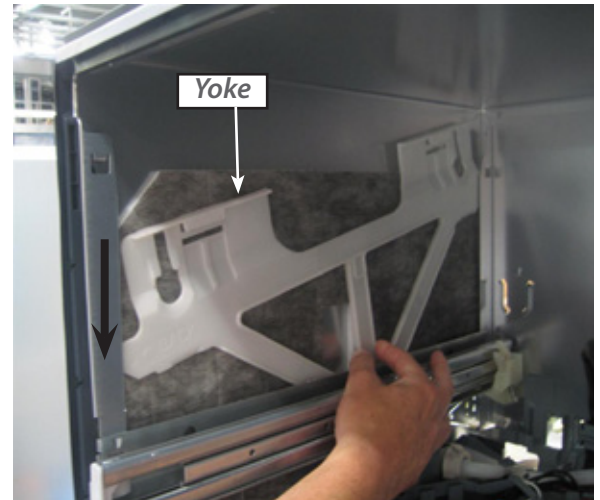

### 9.21 Lid Actuator

1. Remove the tub, refer section 9.6.
2. Remove the lid actuator harness plug by releasing the clip on the lid actuator.
3. Release the lid actuator from the bottom of the yoke by pressing with your thumb against one of the locking tabs.
4. For the right hand actuator, carefully release the clip at the rear of the lid actuator and slide the lid actuator towards the rear of the chassis to release it from the slide rail.
5. For the left hand actuator, the clip is in front of the lid actuator, and once it is released, the lid actuator will slide towards the front of the chassis to release it from the slide rail.
6. The lid actuator can now be removed by dropping it down through the slot in the middle of the mounting bracket.
7. When reconnecting the lid actuator to a yoke, ensure the lid and yoke assemblies are in the fully raised position. To line up the lid actuator connecting arm with the yoke, it may need to be wound up or down manually.



**NOTE:** It is important that all the clips on the lid actuator case are done up and that none are broken.



### 9.22 Slide Rail Replacement.

1. Remove the tub, refer section 9.6
2. Remove the required lid actuator from the slide rail being replaced, refer section 9.21.
3. Remove the appropriate chassis trim (refer section 9.27) to gain access to the screws of the rail being replaced.
4. Remove the 2 hex drive screws securing the rail to the chassis.
5. Tap the slide rails from underneath at the front to free from it's location in the chassis.
6. Pull forward to release the rear locating tabs.
7. Refit in reverse order, take care that the chassis is square before tightening the screws.

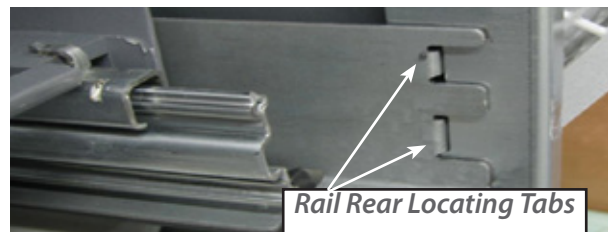
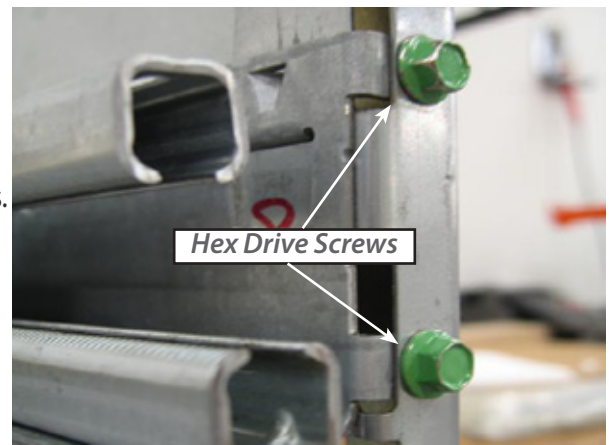

### 9.23 Mains Filter Cover and PCB Mains Filter

1. Remove the lower tub, refer section 9.6
2. Release the clips on the mains filter cover and lift it off.
3. Disconnect all wiring to the PCB mains filter.
4. Remove the earth screw through the wire and the mains filter housing to the chassis.
5. Use a screwdriver to release the clips holding the circuit board inside the housing and lift it out.
6. Refit in reverse manner.

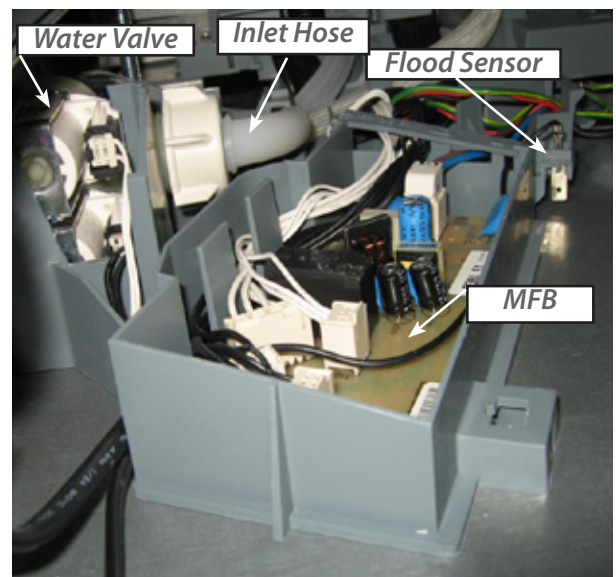
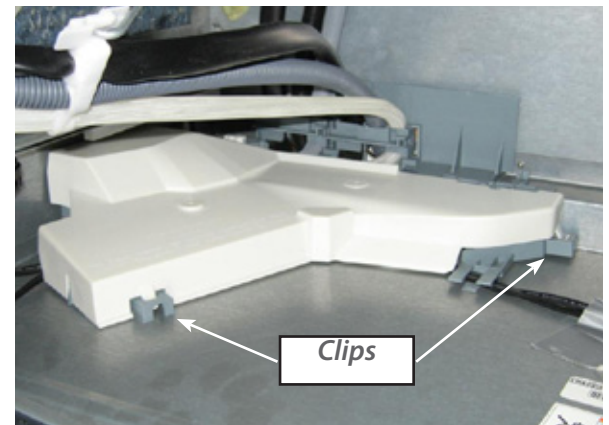





### 9.24 Water Inlet Valve

1. Remove the lower tub, refer section 9.6.
2. Remove the mains filter cover, refer section 9.23.
3. Partially lift the inlet valve up out of the housing.
4. Disconnect the water inlet hose connection, **CAUTION** - water will drip.
5. The water valve can now be removed up and out of the housing.
6. Remove the wire harnesses, and mark which fill hose goes to the top on a double product. Unclip the hose clips by pushing the ends apart sideways, then remove the hoses from the valve.
7. Refit in reverse manner.

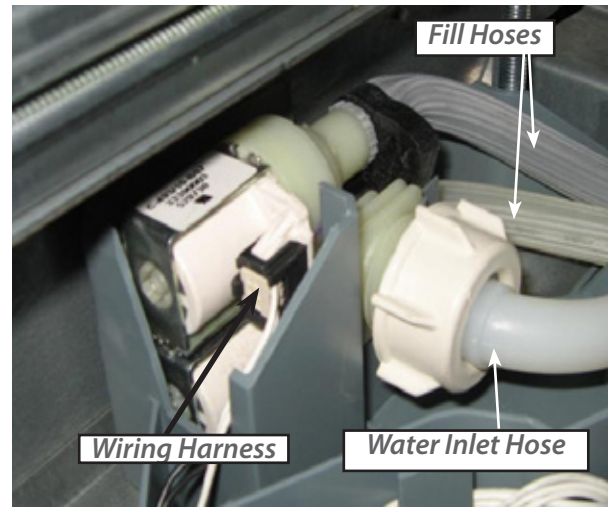

### 9.25 Fill Hose, Drain Hose, Wiring Harness Replacement

1. Remove the tub and turn it over by rotating it anticlockwise (refer section 9.6).
2. Remove the wiring cover, refer section 9.15.
3. Disconnect the component you need to replace (e.g. fill hose, drain hose, wiring harness) from the tub.
4. Undo the link clips and chassis clips, do this one clip at a time, marking the position of the hoses and harnesses at each clip and re-closing it after the component is removed to keep the other two components in their correct positions. The faulty component can now be disconnected from the chassis end and removed.
5. Refit in reverse manner, ensuring the link and chassis clips are clamping the components in their correct location.

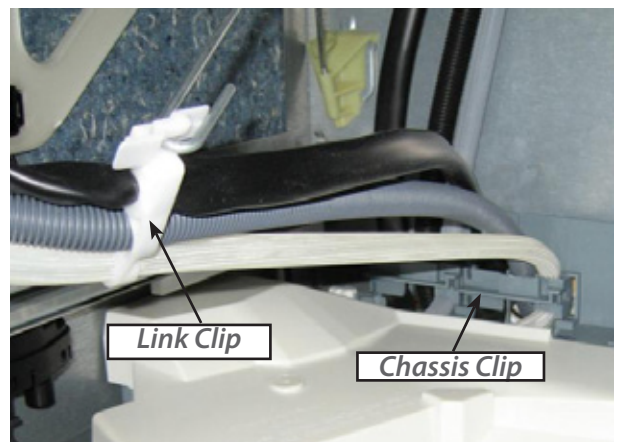

### 9.26 Link Support Wire Position

1. If the latches are resetting, this can be caused by the link support wire being positioned too low and allowing the hoses and harnesses to get between the tub and the latch.
2. To check the position of the wire, remove the tub, and remove the centre link clip from the wire. Swing the wire to the left hand side of the chassis.
3. It should rest approx 15mm (3/4") above the slide mounting bracket. If not, then carefully bend the wire while supporting it at the rear so as not to stress the mounting bracket.

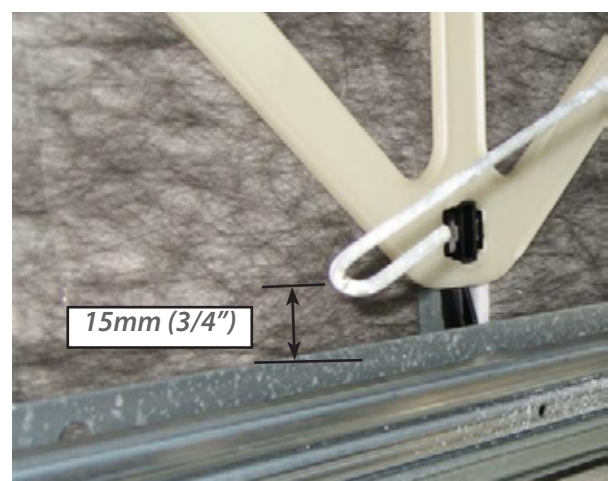



### 9.27 Front Chassis Trim Replacement

1. Bottom tub only - Remove the toe kick, refer section 9.4, and the bottom cowling, refer section 9.5.
2. Remove the drawer front, refer section 9.2, handle refer section 9.3, and the tub, refer section 9.6.
3. Remove both the left hand and right hand yokes, refer section 9.20. This is to prevent damaging the locating tab at the front of each yoke where it slides up into the rear of the chassis trim.
4. Remove the trim by releasing the trim clips with long nose pliers, and pull trim forward to release from the chassis.
5. Refit in reverse manner.

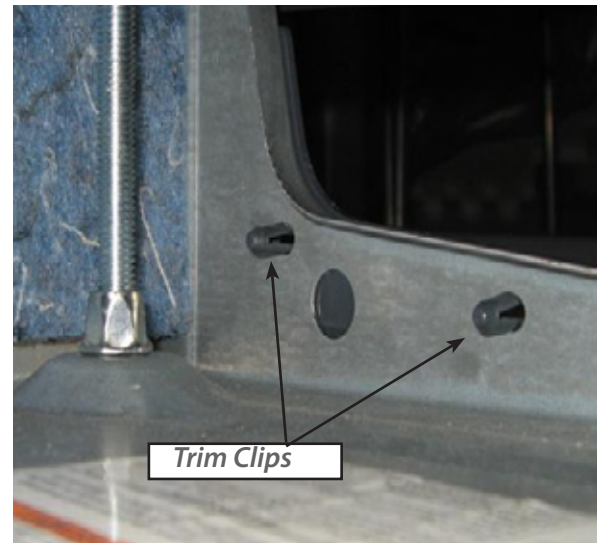

### 9.28 Single Integrated Vent Duct Removal

(Some models only)

1. Remove the drawer front, refer section 9.2.
2. Pull the drawer front slightly forward and remove the T10 torx screw retaining the duct.
3. Slide the duct from the right hand side off the tub.
4. Refit in reverse manner.

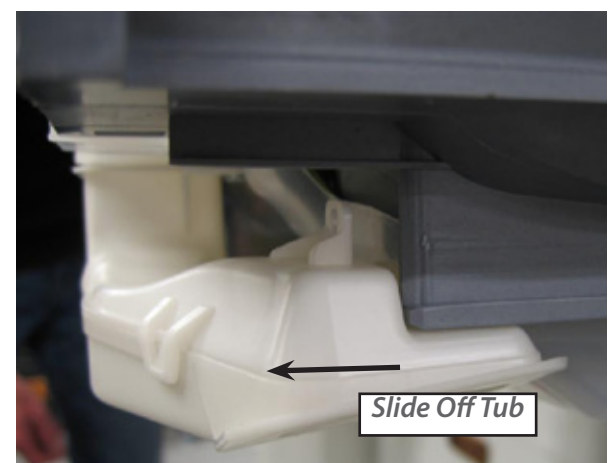
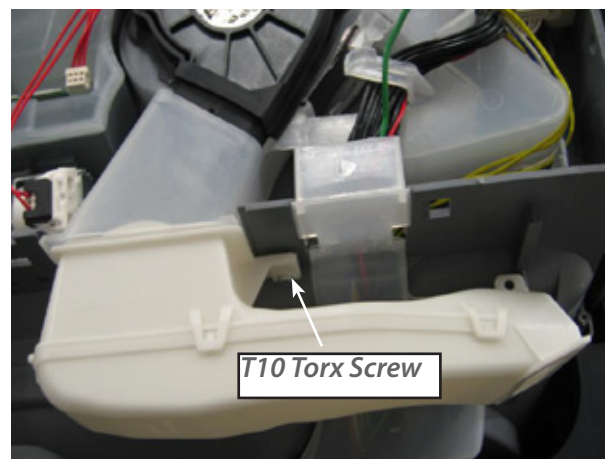



### 9.29 Internal Duct and Elbow Removal (some integrated models only)

1. Remove the tub to gain access to the duct, refer section 9.6.
2. To remove the chassis duct tube, remove the 13mm nut to release the elbow and gently pull the tube from the elbow duct.
3. To remove the rear duct elbow, the product will need to be uninstalled and pulled forward from the joinery to gain access to the elbow. To release elbow from the chassis, squeeze the side tabs and pull outwards.

**NOTE:** When pulling the product forward out of the joinery, remember to feed the service and ducting pipes through the service holes to stop them from getting damaged.

4. The ducting insulated hose is attached to the rear elbow and ducted through the joinery.

**NOTE:** Refer to the product installation guide for more detailed installation information.

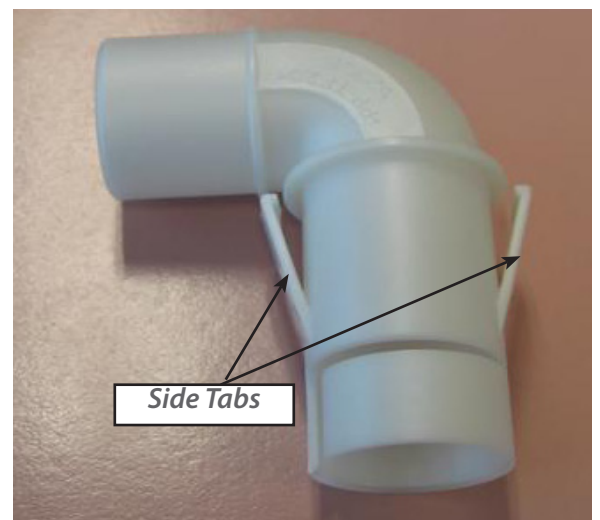
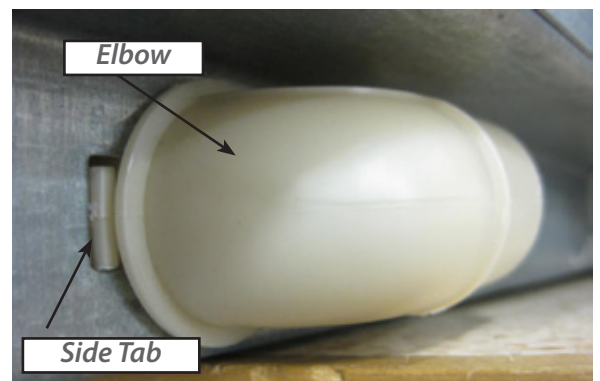





### 9.30 Wireless Receiver & Badge Remote

1. Remove the door panel, refer section 9.2.
2. Remove the harness from the receiver to the controller.
3. Slide the receiver off the locating flange on the tub.
4. When replacing the receiver, the remote control will need to be paired to the new receiver, to do this follow the procedures set out on p73 & 74.
5. For remote control related issues, refer to the procedure set out below.

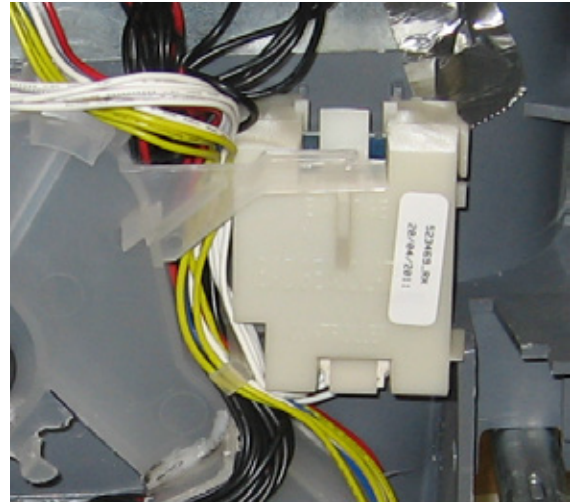

### Remote Control is Not Operating

If the remote has stopped working, first check the battery is fitted correctly and is not flat. The remote control has a low battery indicator which will blink to advise a low battery.

Secondly, check the remote for contact with water.

Remove the battery cover from the remote and inspect the colour of the dot beside the battery.

If the dot is **WHITE** then the remote has **NOT** come into contact with water and the fault should be treated in accordance with normal warranty procedures.

If the dot is **RED** the remote has come into contact with water and the warranty of the remote is void (i.e. the customer will have to pay for a replacement remote).

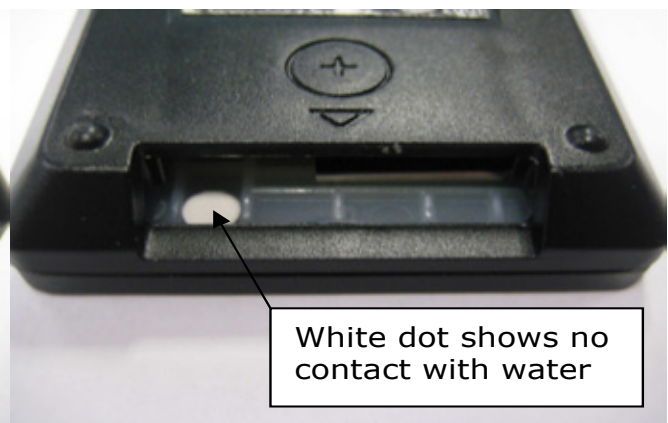
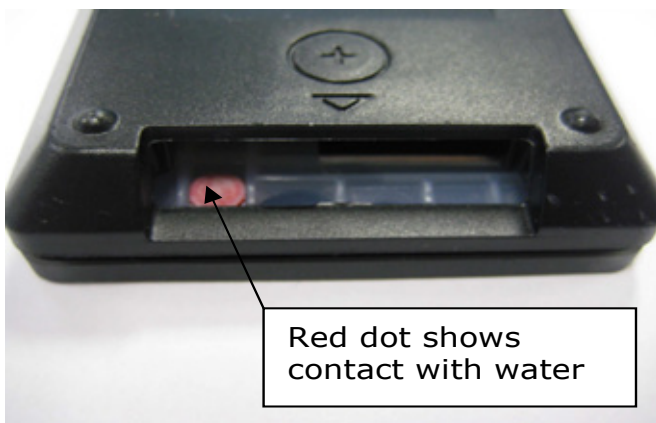



## Pairing Procedure

This procedure details how to fit and pair the wireless interface (badge and receiver) on an integrated Phase 7 product.

The wireless badge (or remote) interface for integrated products consists of 2 specific modules, a remote control and a receiver.

**NOTE:** For each integrated product with the wireless badge, there is only **one** remote and **one** receiver, regardless of whether it is a single or double product.

### Receiver Replacement Procedure:

First fit the receiver to the product. The receiver sits in the same location as the badge isolator on a designer product and plugs into the 'LCD/BADGE' input. On a double product, the receiver is to be fitted to the **top tub only** and nothing is to be connected to the 'LCD/BADGE' input of the bottom tub.

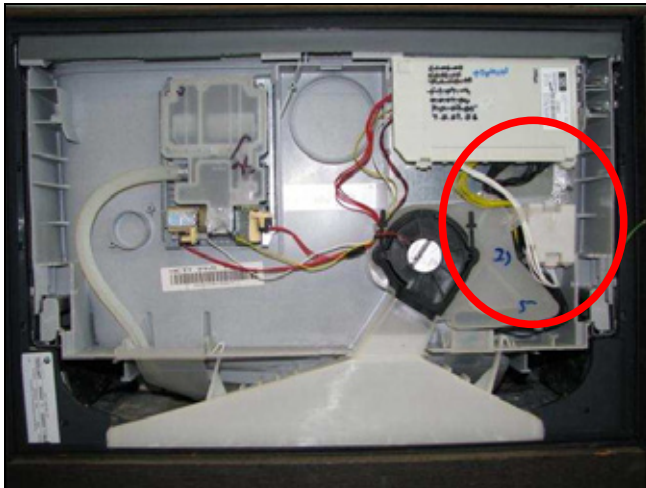

Receiver fitted to a single product

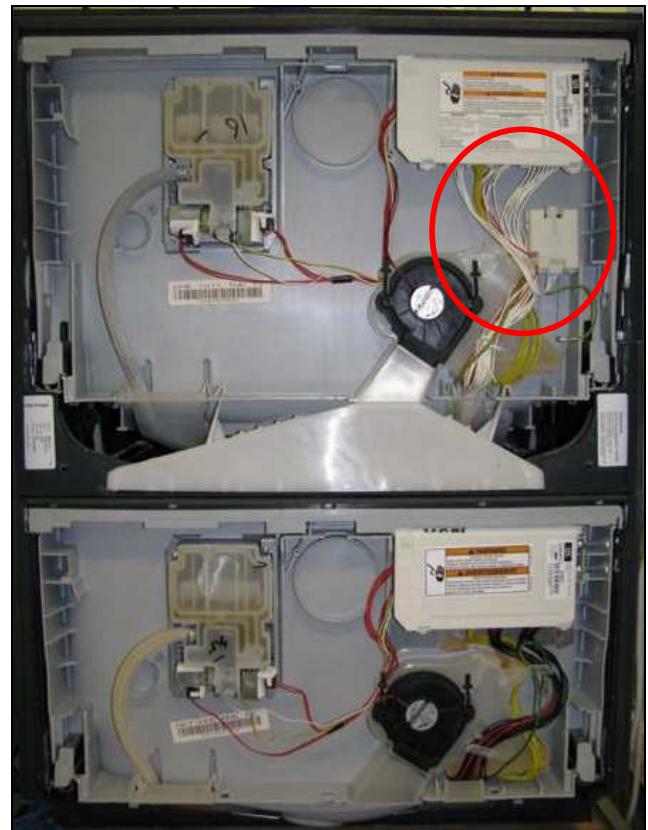

Receiver fitted to a double product

## To Pair Remote to Receiver

Before the product will function, the remote must be paired to the receiver. This ensures that the remote only operates the correct DishDrawer.

- i) Press one of the buttons to make sure that the remote is powered, the 'Transmit indicator' should flash.
- ii) Ensure there is power to the product. If the receiver is connected correctly, the product should power up and play the startup sound. Place the remote on the wash programme selector as shown.



Place of the remote for binding

- iii) Once the remote is in roughly the location shown above, press one of the buttons on the remote. The left transmit LED icon should flash followed by five fast flashes of the right hand battery icon. This indicates that remote has paired with the receiver. The LEDs are labelled below.

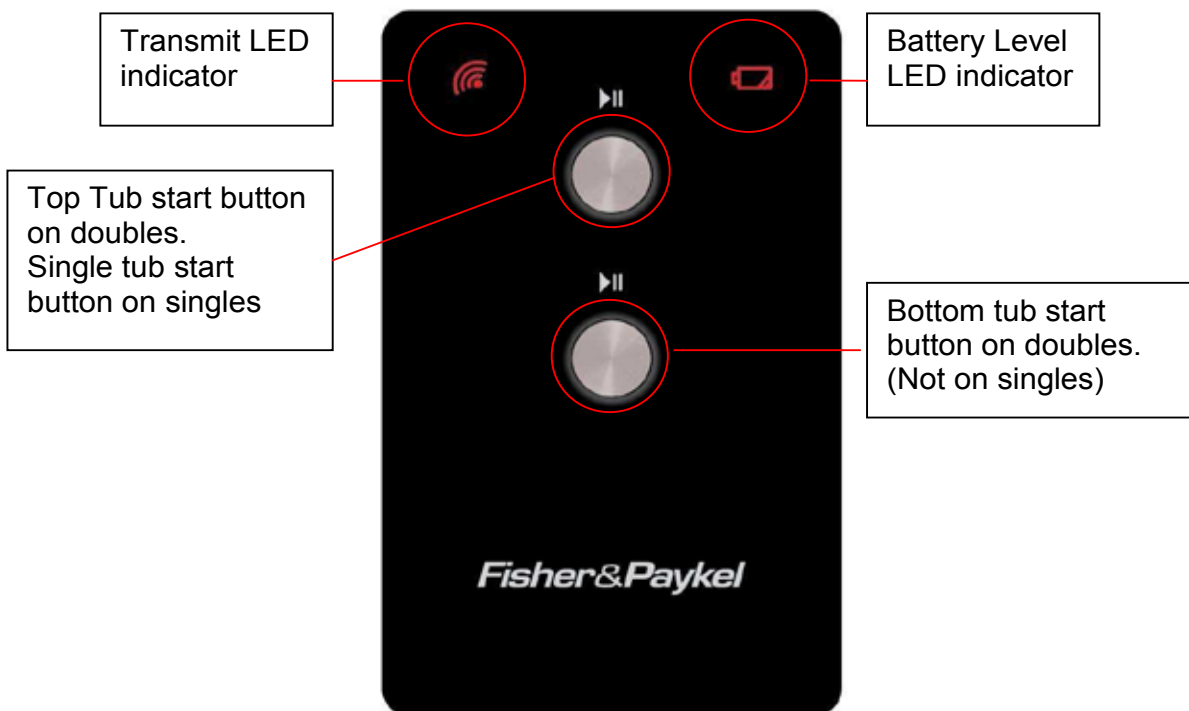

- iv) Remove the remote from the wash programme selector. Now press a button on the remote. This should flash the 'transmit' LED once and cause the relevant tub to 'beep'.
- v) If the above is successful it means the remote is paired to the receiver. If either the remote or receiver is replaced then the procedure must be repeated.





*Fisher & Paykel*  
appliances

customer care™

[www.fisherpaykel.co.nz](http://www.fisherpaykel.co.nz)  
[www.fisherpaykel.com.au](http://www.fisherpaykel.com.au)  
[www.fisherpaykel.co.uk](http://www.fisherpaykel.co.uk)  
[www.fisherpaykel.ie](http://www.fisherpaykel.ie)  
[www.fisherpaykel.com](http://www.fisherpaykel.com)  
[www.fisherpaykel.ca](http://www.fisherpaykel.ca)

*Fisher & Paykel*

Copyright © Fisher & Paykel 2010. All rights reserved.

The product specifications in this booklet apply to the specific products and models described at the date of issue. Under our policy of continuous product improvement, these specifications may change at any time. You should therefore check with your Dealer to ensure this booklet correctly describes the product currently available.

## Free Manuals Download Website

<http://myh66.com>

<http://usermanuals.us>

<http://www.somanuals.com>

<http://www.4manuals.cc>

<http://www.manual-lib.com>

<http://www.404manual.com>

<http://www.luxmanual.com>

<http://aubethermostatmanual.com>

Golf course search by state

<http://golfingnear.com>

Email search by domain

<http://emailbydomain.com>

Auto manuals search

<http://auto.somanuals.com>

TV manuals search

<http://tv.somanuals.com>