



## **Installation instructions and user guide**

### **Food waste disposer**

GD75IA1

NZ



Safety and warnings	2
Installation instructions	3
Operating instructions	8
Cleaning and maintenance	9
Troubleshooting	10
Manufacturer's warranty	11
Customer care	12

## ***Important!***

### **SAVE THESE INSTRUCTIONS**

*The models shown in this user guide may not be available in all markets and are subject to change at any time. For current details about model and specification availability in your country, please go to our website listed on the back cover or contact your local Fisher & Paykel dealer.*

## 2 Safety and warnings

Use this appliance only for its intended purpose as described in this User Guide.

### **Important safety precautions !**

When using this appliance, always use basic safety precautions, including the following:

#### **Danger!**

- *This appliance is not intended for the use by children or infirmed persons without supervision.*
- *To reduce the risk of injury, close supervision is required when a waste disposer is used near children.*
- *Do not put fingers or hands into the waste disposer.*
- *Unplug the unit before attempting to clear a jam or remove an object from the disposer.*
- *As the waste disposer is magnetic, use only non-magnetic tools such as a wooden spoon or long handled plastic tongs when attempting to loosen a jam or remove objects from the waste disposer.*
- *To reduce the risk of injury by materials that may be expelled by a waste disposer, do not put non-food items, or any of the following into the food waste disposer:*
  - a) *Shells, such as mussel or oyster shells.*
  - b) *Caustic drain cleaners or similar products.*
  - c) *Glass, china or plastic.*
  - d) *Large whole bones.*
  - e) *Metal, such as bottle caps, tin cans, utensils or aluminium foil.*
  - f) *Hot grease or other hot liquids.*
  - g) *Whole corn husks or similar fibrous material.*
- *When not operating the waste disposer, leave the drain stopper in place to reduce the risk of objects falling into the disposer.*
- *Your new appliance must be properly installed in accordance with the installation instructions before it is used.*
- *Never unplug the waste disposer by pulling on the power cord.*
- *Always grip the plug firmly and pull straight from the outlet.*
- *Repair or replace immediately all electric service cords that have become frayed or otherwise damaged.*
- *Power cords must be replaced by a qualified electrician or authorised service engineer.*
- *Do not use a cord that shows cracks or abrasion along it's length or at either the plug or appliance end.*

### **⚠ WARNING!**



#### **Electrical Shock Hazard**

To reduce the risk of electric shock or injury to persons, read the IMPORTANT SAFETY PRECAUTIONS before operating this appliance.

**SAVE THESE INSTRUCTIONS**

Download from [Www.Somanuals.com](http://www.Somanuals.com). All Manuals Search And Download.

## Before you begin

**Please read these installation instructions completely and carefully.**

- The following installation instructions are intended as a general guide.
- Please ensure that the waste disposal unit is installed according to local building codes for your area.
- Installation is recommended to be done by a qualified plumber or installer.
- Product failure due to improper installation is not covered under the Warranty.

## Preparation

### Removing an existing waste disposer, if installed

- 1 Disconnect electrical power supply to existing disposer.
- 2 Remove old disposer or sink flange assembly.
- 3 Inspect drain line. If it is heavily coated with hardened grease and accumulations, clear out the build-up using a plumber's rod or auger.
- 4 Remove old sealing materials and gaskets from sink opening, both top and bottom.

### What you will need

- Phillips screwdriver
- Flat blade screwdriver
- Steel Punch or wooden dowel
- Petroleum jelly or liquid soap
- Plumber's Putty

## ***Important!***

*Top and bottom of sink and sink flange surfaces must be free of any materials to prevent leaks.*

## 4 Installation instructions

### Unpacking your waste disposer

- 1 Remove the waste disposer from the packaging.
- 2 Identify and check that all components are included in the carton before beginning the installation (fig. 1).
- 3 Take care not to misplace any of the components.

### Components

1. Stopper
2. Sink flange
3. Rubber gasket
4. Flange ring
5. Protector ring
6. Mount ring
7. Screw clamp
8. Hopper with splash guard
9. Dishwasher discharge inlet
10. Drain housing
11. Reset button
12. Built in air-switch
13. Lower shell
14. End Bell (Electrical Connections)
15. Power cord
16. Outlet gasket
17. Discharge waste elbow
18. Waste elbow flange nut

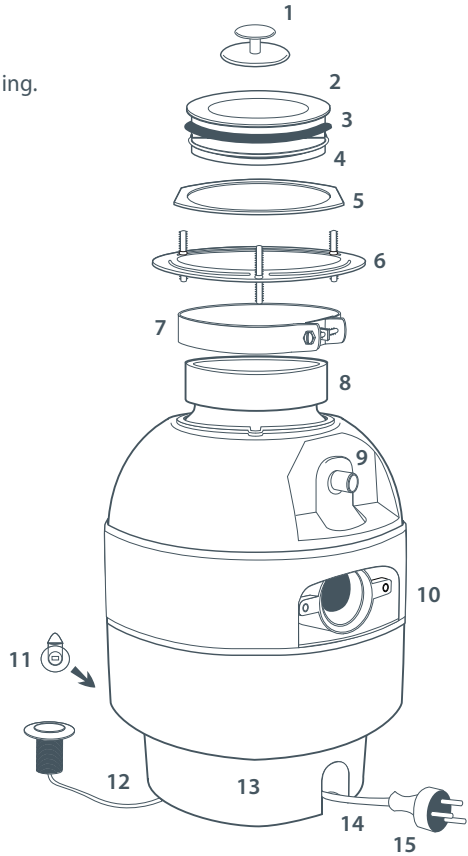

Fig 1. Three Bolt Mount System

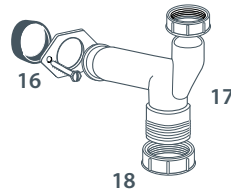

Fig 1.2. Elbow

## Installing the waste disposer

- 1 Loosen the clamp screw to allow the mounting system to be removed from the unit (fig.2).
- 2 Turn the mounting assembly over and remove the flange ring from the track on the sink flange. Undo the three screws holding it together. This will allow the sink flange, mount ring, and protector ring to separate (fig 3).  
Use the flat blade screwdriver as a lever if required.
- 3 Apply a small amount of plumbers putty to the lip of the sink flange and position the sink flange into the sink drain hole ensuring that the rubber gasket on the underside of the sink flange is firmly in place (fig.4).
- 4 Approaching from under the sink, slide the protector ring and mount ring onto the underside of the sink flange. Fit the flange ring into the track on the sink flange, then tighten the 3 mounting screws evenly and securely (fig.5).

### Note:

Ensure that the mounting assembly connection is fixed securely and tightly.

### No dishwasher connection required

If a dishwasher is not being connected to the waste disposer, please proceed to step 7.

### Connecting to a dishwasher

If you are connecting to a dishwasher, please continue with steps 5 & 6.

- 5 Using a blunt instrument (steel punch or wooden dowel), knock out the entire plug at the end of the dishwasher drain inlet (as shown in fig.6). Do not use a screwdriver or sharp instrument. When the knockout plug falls into disposer, you may remove it or simply grind it up when the disposer is used. This will not damage the disposer in any way, but may take some time to grind, over the course of several uses.
- 6 Connect the dishwasher drain hose to the dishwasher inlet pipe on the waste disposer (fig. 6). Use a clamp to ensure a tight seal. A stepped rubber adaptor (not supplied with the product) may be required if the diameter of the drain hose is larger than the diameter of the waste disposer's inlet connection.

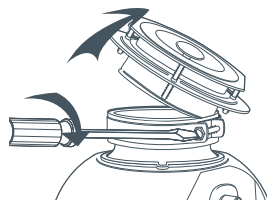

Fig. 2 Removing the mounting system from the waste disposer

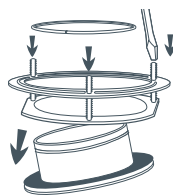

Fig. 3 Disassembling the mounting system

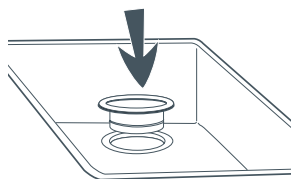

Fig. 4 Fitting the flange into the sink drain hole

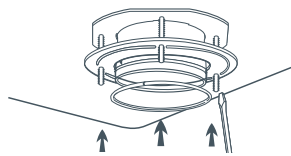

Fig. 5 Fixing the mounting system to the underside of the sink

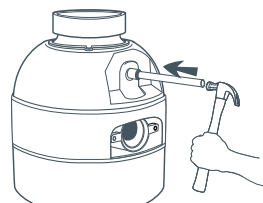

Fig. 6 Connecting to a dishwasher (if required)

## 6 Installation instructions

- 7 Connect the discharge elbow to the lower outlet on the waste disposer (fig. 7).
- 8 Prior to connecting the waste disposer to the mounting assembly, press firmly down on the rubber splash guard to check that it is firmly fitted onto the neck of the hopper.
- 9 Lubricate the top lip and angled surface of the rubber splash guard with liquid soap or petroleum jelly (fig. 8 ).

### **Important!**

*Please do not remove clamp and splash guard from hopper. Both parts are factory installed and installation ready.*

- 10 Align the discharge elbow up with the waste pipe (refer to fig.11) so that the waste disposer is correctly positioned, prior to engaging with the mounting assembly.
- 11 Guide the waste disposer up to the sink flange (fig. 9). Engage the groove of the splash guard around the ridge at the bottom of the sink flange. A slight rocking motion may be required to help ensure a proper fit.
- 12 While still supporting the body of the waste disposer, tighten the screw clamp around the rubber splash guard (fig.10). The waste disposer will now hang by itself.
- 13 Connect the discharge elbow up with the waste pipe (fig.11) and tighten the slip nut on the drain pipe.

### **Note:**

If you need to rotate the waste disposer to connect with the waste pipe, it is important to make sure the sink flange does not turn. Movement of the sink flange will break the seal. If this occurs, disengage the waste disposer from the discharge elbow and mounting assembly. Return to step 10 to realign the waste disposer before repeating steps 11-13.

### **Important**

*Ensure that the reset button is readily accessible after installation of the waste disposer.*

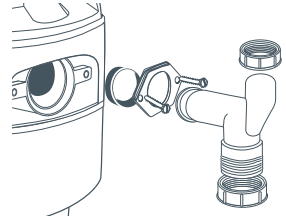

Fig. 7 Connecting the discharge elbow

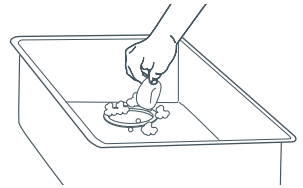

Fig. 8 Lubricate the rubber splash guard

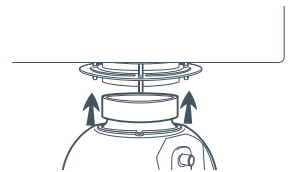

Fig. 9 Engage the waste disposer

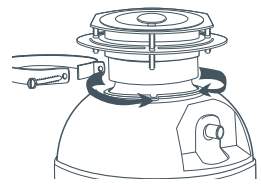

Fig. 10 Tightening the clamp

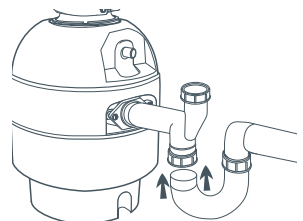

Fig. 11 Connecting the drain outlet



## Installing the air-switch (optional)

- 1 Select a location on the bench top for the air switch to be positioned (recommended position is near the sink). Mark and cut a hole, 33mm in diameter, in the bench top.
- 2 Remove the nut from the thread of the air switch (fig.12).
- 3 Feed one end of the PVC tubing up through the cutout, from the underside of the bench top, and attach to the underside of the push button.
- 4 Insert the push button into the bench top cut out (fig.12). Feed the PVC tube through the nut. Screw the nut onto the thread tightly (fig.13), securing the push button tightly onto the bench top.



Fig. 12 Fitting the air switch

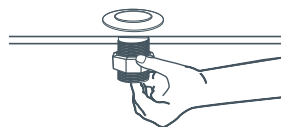

Fig. 13 Securing to the bench top

### Note:

Do not use a wrench to tighten the nut.

- 5 Connect the other end of the PVC tubing to the air switch outlet, located on the underside of the waste disposer (fig.14).

## Controlling the waste disposer by a wall mounted switch

The waste disposer can be controlled by means of a wall mounted switch rather than the bench mounted air switch supplied with the product.

To use an existing wall mounted switch:

- 1 Connect one end of the PVC tubing to the underside of the air switch button.
- 2 Connect the other end of the PVC tubing to the air switch outlet on the underside of the waste disposer (as shown in fig.14).
- 3 Press the button on the air switch to activate the waste disposer.
- 4 Whilst the waste disposer is running, disconnect the PVC tubing from the air switch outlet on the underside of the waste disposer.
- 5 Turn the waste disposer off using the wall mounted switch. The waste disposer can now be turned on and off using the wall mounted switch.

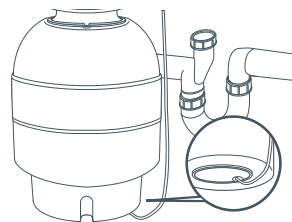

Fig. 14 Connecting tube to air switch outlet

## 8 Operating instructions

### Operating instructions

- 1 Remove the sink stopper and turn on a medium flow of cold water.

**Note:**

Do not use hot water. Only cold water should be run through the waste disposer.

- 2 Press the air switch or the wall mounted switch to activate the waste disposer.
- 3 Feed food items through the sink opening of the waste disposer gradually.

**Note:**

Overloading the waste disposer with too much food waste at once may cause the blades to jam and the disposer to shut down. The overload button may be required to be reset. Refer to the Overload Reset button section on page 9.

### ***Caution!***

*Do not put hands or fingers into the waste disposer.*

- 4 Before turning the waste disposer off, let the water and the disposer run for approximately half a minute after shredding stops. This assures that all the food waste is thoroughly flushed through the trap and drain.

### Helpful Hints

- If a dishwasher drain hose has been connected to the waste disposer, be sure that the waste disposer's chamber is empty before using the dishwasher to ensure the dishwasher is able to drain properly.
- It is recommended to leave the stopper in the drain when the disposer is not in use to prevent utensils and foreign objects from falling into the waste disposer.
- The waste disposer is designed to give you years of trouble-free service. The grind mechanism is built to handle all normal food wastes, but WILL NOT grind and dispose of items such as tin cans, bottles, bottle caps, glass, china, leather, large bones, mussel or oyster shells. These are waste materials that should be collected with your household rubbish.
- We recommend cutting or breaking up items which require considerable grinding time, such as melon rinds, grapefruit skins, bones and corn cob husks or dispose of these items with your household waste collection.

Your waste disposer is self-cleaning and scours itself with each use. Under normal usage, your waste disposer will not require any special care.

**Note:**

Always run cold water into the chamber before, during and after using the waste disposer. Do not use hot water.

## Removing an odour

- Grinding up a tray of ice cubes will help to clean the shredding plate.
- Running orange or lemon rinds through the waste disposer will help to freshen up the grinding chamber.

**Note:**

- Do not pour bleach or drain cleaners, into the waste disposer
- Never put corrosive substances or chemicals into the waste disposer.

## Unblocking a jam

- 1 Before investigating a blockage, you **MUST** disconnect the power supply.
- 2 The waste disposer is magnetic. **ALWAYS** use non-magnetic tools, such as a wooden spoon or long handled plastic tongs when attempting to loosen a jam or remove an object from the waste disposer.
- 3 After clearing the blockage or jam, turn the power back on, turn on a medium flow of cold water and run the waste disposer for half a minute to ensure that all the food waste is thoroughly flushed through the trap and drain.

**Note:**

If the motor does not start when activated, refer to the Overload Reset Button section below or the Troubleshooting guide on page 9.

## Overload Reset button

The waste disposer is fitted with an overload control which prevents the motor from operating should overloading occur. Overloading occurs when the motor is unable to turn, usually caused by a foreign object falling in to the chamber or too much food waste being fed through into the chamber at once, jamming the shredding plate.

When overloaded the motor will stop automatically. To restart the motor the overload reset button must be pressed.

The reset overload button is a small red button located opposite the power cord outlet, near the bottom of the waste disposer. Before resetting the overload button, you **MUST** disconnect the power supply.

## ***Important!***

*The motor is permanently lubricated for life. Do not attempt to lubricate your waste disposer.*

## Troubleshooting tips

Problem	Possible causes	What to do
Waste disposer is not starting	No electricity at the power outlet.	Check that the plug is correctly connected and power is turned on. Check another appliance at the same outlet. Check house fuse.
	Air switch tubing not connected	Check that the air switch, or wall switch, is correctly connected. Refer to page 7 of the installation instructions.
	Foreign object may be lodged between the turntable and grinding ring.	Turn power supply and water tap off. Rotate the turntable, using a plastic, wooden or non-magnetic implement to dislodge the foreign object.
	Grinding chamber may be overloaded with food waste or foreign matter.	Turn the power and water tap off and, using a plastic, wooden or non-magnetic implement, remove the food waste or foreign matter. Refer to the operating instructions section.
	Safety overload button may have tripped.	The reset overload button is a red button located externally, opposite the power cord outlet, near the bottom of the waste disposer.
Abnormal noise when operating	A spoon, bottle cap or other foreign object may have fallen into the waste disposer	Turn power supply and water tap off. Wait until grinding blades and turntable has stopped turning. Use a plastic, wooden or non-magnetic implement to remove the foreign object.
Waste disposer is jammed	Foreign object may be lodged between the turntable and grinding ring.	Turn power supply and water tap off. Rotate the turntable, using a plastic, wooden or non-magnetic implement to dislodge the foreign object.
Unit is leaking at the top connections	Improper seating of the sink flange.	Check that the sink flange is centred and sealed tightly into the sink drain by the mounting assembly from underneath. Refer to step 2 of the installation instructions.
	Improperly installed rubber gasket.	Check that the rubber gasket is sitting flat under the lip of the sink flange. Refer to step 2 of the installation instructions.
	Mount ring not tightened properly	Discharge outlet elbow may not be tightened. Check the discharge elbow is tight. Refer to step 13 of the installation instructions.
Unit is leaking at the discharge outlet.	Discharge outlet elbow may not be tightened.	Check the discharge elbow is tight. Refer to step 13 of the installation instructions.
Water is slow to drain from the sink	Rubber splash guard fingers trapping air inside the chamber.	When the rubber splash guard is new, air can become trapped within the chamber preventing water from draining quickly. Pushing food through the rubber splash guard will release the air and the water will drain. Over time, the splash guard fingers will soften and flex, holding back less air and aiding drainage.

## Fisher & Paykel undertakes to

Repair or, at its option, replace without cost to the owner either for material or labour any part of the Product, the serial number of which appears on the Product, which is found to be defective within TWO YEARS from the date of purchase.

## This warranty DOES NOT Cover

- A** Service calls which are not related to any defect in the Product. The cost of a service call will be charged if the problem is not found to be a Product related fault. For example:
  1. Correct the installation of the product.
  2. Instruct you how to use the product.
  3. Replace house fuses or correct house wiring.
  4. Correcting fault(s) caused by the user.
  5. Correcting damage caused by pests, eg. rats, cockroaches etc.
- B** Defects caused by factors other than:
  1. Normal domestic use or
  2. Use in accordance with the Product's User Guide.
- C** Defects to the Product caused by accident, neglect, misuse or 'Act of God'.
- D** The cost of repairs carried out by non-authorised repairers or the cost of correcting such unauthorised repairs.
- E** Normal recommended maintenance as set out in the Product's User Guide.
- F** Repairs when the appliance has been dismantled, repaired or serviced by other than a Fisher & Paykel AUTHORISED CUSTOMER SERVICE CENTRE or the selling dealer.
- G** Pick up and delivery.
- H** Transportation or travelling costs involved in the repair when the product is installed outside the Fisher & Paykel AUTHORISED CUSTOMER SERVICE CENTRE'S normal service area.

Service under this manufacturer's warranty must be provided by an Authorised Service Agent (refer to the Customer care section for contact details). Such service shall be provided during normal business hours. This warranty certificate should be shown when making any claim.

### **Note:**

This Warranty is an extra benefit and does not affect your legal rights and applies only to product purchased in New Zealand and Australia.

**Please keep this User Guide in a safe place.**

**Do not return to Fisher & Paykel.**

Check the things you can do yourself.  
Refer to your User Guide and check:

- 1 your appliance is correctly installed
- 2 you are familiar with its normal operation

**Fisher & Paykel**  
appliances

**customer care™**

If after checking these points you still need assistance, please refer to your nearest Authorised Service Centre, or contact us through our local website listed on the back cover.

### In New Zealand if you need assistance...\*

Call your Fisher & Paykel retailer who is trained to provide information on your appliance, or if we can be of any further help, please contact our Customer Care Centre,

**Toll Free:** 0800 FP CARE or 0800 37 22 73      **Fax:** (09) 273 0656

**Email:** customer.care@fp.co.nz

**Postal address:** P.O. Box 58732, Greenmount, Auckland

### If you need service...\*

Fisher & Paykel has a network of independent Fisher & Paykel Authorised Service Centres whose fully trained technicians can carry out any service necessary on your appliance. Your dealer or our Customer Care Centre can recommend an Authorised Service Centre in your area.

### In Australia if you need assistance...\*

Call the Fisher & Paykel Customer Care Centre and talk to one of our Customer Care Consultants.

**Toll Free:** 13 00 650 590

**Fax:** (07) 3826 9298

**Email:** customer.care@fp.com.au

**Postal Address:** PO Box 798, Cleveland QLD 4163

### If you need service...\*

Fisher & Paykel Australia Pty Ltd has a network of independent Fisher & Paykel Authorised Service Centres whose fully trained technicians can carry out any service necessary on your appliance. Our Customer Care Centre can recommend an Authorised Service Centre in your area.

\*If you call or write, please provide: name, address, model number, serial number, date of purchase and a description of the problem. This information is needed in order to better respond to your request for assistance.

## Product Details

Fisher & Paykel Appliances Ltd

### Model/Serial No.

**Date of Purchase** \_\_\_\_\_ **Purchaser** \_\_\_\_\_

**Dealer** \_\_\_\_\_ **Suburb** \_\_\_\_\_

**Town** \_\_\_\_\_ **Country** \_\_\_\_\_



Copyright © Fisher & Paykel 2008. All rights reserved.  
The product specifications in this booklet apply to the specific products and models described at the date of issue. Under our policy of continuous product improvement, these specifications may change at any time. You should therefore check with your Dealer to ensure this booklet correctly describes the product currently available.

**[www.fisherpaykel.co.nz](http://www.fisherpaykel.co.nz)**

NZ

Food waste disposer installation  
and user guide

Published: 09/2008

**Part No. 791634**



## Free Manuals Download Website

<http://myh66.com>

<http://usermanuals.us>

<http://www.somanuals.com>

<http://www.4manuals.cc>

<http://www.manual-lib.com>

<http://www.404manual.com>

<http://www.luxmanual.com>

<http://aubethermostatmanual.com>

Golf course search by state

<http://golfingnear.com>

Email search by domain

<http://emailbydomain.com>

Auto manuals search

<http://auto.somanuals.com>

TV manuals search

<http://tv.somanuals.com>