

User guide

Built-in oven

BI453 and BI603 'classic range' models

NZ AU

Introduction	2
Safety and warnings	3
Overview of oven models	4
Clocks and timers	5
Operating the oven	9
Cooking functions	10
Automatic cooking	11
Oven shelves	13
Accessories	14
Oven temperature conversion chart	14
Cooking function options	15
Cooking charts	16
Care and cleaning - oven	24
Ceramic cooktop (CTE)	26
Care and cleaning - ceramic cooktop (CTE)	28
Warranty and service	29

Important!

SAVE THESE INSTRUCTIONS

The models shown in this user guide may not be available in all markets and are subject to change at any time. For current details about model and specification availability in your country, please go to our website www.fisherpaykel.com or contact your local Fisher & Paykel dealer.



2 Introduction

About your new oven

Thank you for buying a Fisher & Paykel built-in oven. Now that it is installed and ready to use, you will want to know everything about it to make sure you get excellent results right from the start. This guide introduces you to all its features, as well as giving you a comprehensive set of cooking charts. We recommend you read the whole guide before using your new oven, for both safety and cooking success.

Before using your new oven

Before using your new oven, please:

- Read this user guide, taking special note of the 'Safety and warnings' section following.
- Remove all accessories and packaging (from both ovens in double models).
- Set the clock. The oven will not work until the clock has been set. See the 'Clocks and timers' section.
- Condition the oven/s by turning the function knob to FAN BAKE  and the temperature knob to 200 °C and heat for one hour. You can condition both ovens in double models at the same time. The upper oven controls are on the right  and the lower on the left .

There will be a distinctive smell while you are conditioning your oven. This is normal, but make sure your kitchen is well ventilated during the conditioning.

Your built-in oven has been carefully designed to operate safely during normal cooking procedures. Please keep the following guidelines in mind when you are using your oven.

! WARNING!



Hot Surface Hazard

Accessible parts will become hot when this oven is in use.
 Accessible parts may become hot when the grill is in use with the door open.
 To avoid burns and scalds keep children away.
 Do not touch hot surfaces inside the oven.
 Use oven mitts or other protection when handling hot surfaces such as oven shelves or dishes.
 Take care when opening the oven door.
 Let hot air or steam escape before removing or replacing food.
 Failure to do so could result in burns and scalds.

! WARNING!



Electrical Shock Hazard

Switch the oven off at the wall before replacing fuses or the oven lamp.
 Do not use the appliance if the cooktop surface is cracked. Switch the appliance off at the power supply and contact your service centre.
 Failure to do so may result in death or electrical shock.

Important safety precautions

- *Isolating switch: make sure this oven is connected to a circuit which incorporates an isolating switch providing full disconnection from the power supply.*
- *Household appliances are not intended to be played with by children.*
- *Children, or persons with a disability which limits their ability to use the appliance, should have a responsible person to instruct them in its use. The instructor should be satisfied that they can use the appliance without danger to themselves or their surroundings.*
- *Safe food handling: leave food in the oven for as short a time as possible before and after cooking. This is to avoid contamination by organisms which may cause food poisoning. Take particular care during warmer weather.*
- *Do not place aluminium foil or dishes with reflective qualities on the oven floor as this will cause a heat build-up which will irreversibly damage the enamel.*
- *Do not stand on the door, or place heavy objects on it.*
- *Do not use a steam cleaner to clean any part of the oven or the ceramic cooktop.*
- *Do not use harsh abrasive cleaners or sharp metal scrapers to clean the oven door glass since they scratch the surface, which may result in shattering of the glass.*
- *When the safety cover is retracted the blade in the cooktop scraper is razor-sharp. Use with extreme care and always store safely.*

4 Overview of oven models

Built-in oven models

Depending on which model you have, your built-in oven will have one of the following control panels.



Ringer timer (R)

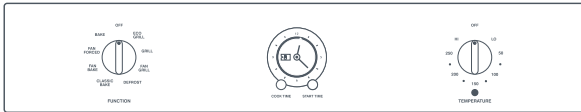

Analogue clock (A)

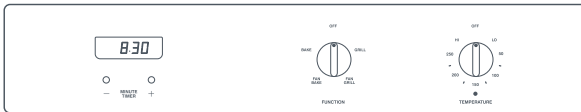

Electronic clock with minute timer (C)

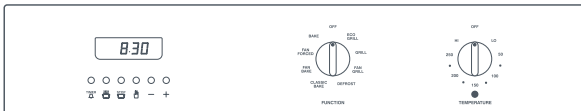

Electronic clock (E)

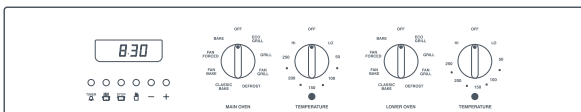

Double oven with electronic clock (ED)



Oven with cooktop and electronic clock (CTE)

Fig.1 Oven models

Types of clock

You have to set the clock before you can use the oven. Depending on which model you have (see 'Overview of oven models') your oven may have a ringer timer, an analogue clock, an electronic clock with minute timer, or an electronic clock.

Ringer timer model (R)

The timer can be used at any time even if the oven is not in use.
The timer can be set for up to 55 minutes.

If the oven is in use, the timer does not turn the oven off.

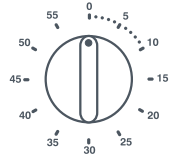

Fig.2 Ringer timer

Setting the timer

Turn the timer control knob clockwise to the 55 minute mark, then turn it back to show the number of minutes you want. The timer will count down and will ring when the set time is reached.

6 Clocks and timers

Analogue clock model (A)



Timer



Timer bell off stops the timer bell ringing.



Start time sets a time for automatic cooking to start.



Manual symbol returns the oven to manual mode when automatic cooking is finished.

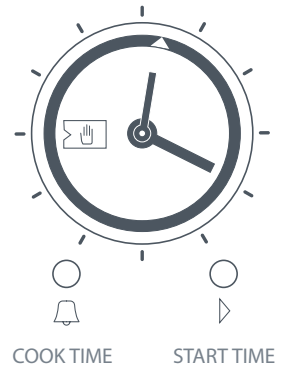



Fig.3 Analogue clock



Setting the analogue clock

To set the clock:

- 1 Turn the COOK TIME knob anticlockwise until the  symbol shows.
- 2 Press and turn the COOK TIME knob anticlockwise until the clock shows the correct time.
- 3 Press and turn the START TIME knob anticlockwise until the  triangle clicks into alignment with the hour hand.

Setting the timer

You can use the timer at any time, even when the oven is not in use. If the oven is in use, the timer will turn the oven off when the selected time has elapsed.

- To set the timer, turn the COOK TIME knob anticlockwise until the number of minutes you want shows in the centre of the display, eg 60 minutes. When the time is up, the timer will ring and the oven will turn off.
- To turn the timer bell off, turn the COOK TIME knob anticlockwise to the  symbol.
- To return the oven to manual mode, turn the COOK TIME knob anticlockwise to the  symbol.

Electronic clock with minute timer model (C)

Setting the electronic clock

- To set the clock, press and hold the – + buttons together briefly (0.00 will stop flashing). You have six seconds to start setting the clock. Press the – or + button until the correct time is displayed. If you make a mistake, press the – + buttons together and correct the time.
- To adjust the time for daylight savings you can reset the hours only. Press and hold the – + buttons together until the hour digits begin flashing, release the – + buttons and re-press either the – or + button until the correct time is displayed.



Fig.4 Electronic clock with minute timer

Setting the minute timer

You can use the timer at any time, even when the oven is not in use. The timer does not turn the oven off and has a maximum setting of 10 hours.

- To set the timer, press the – or + button briefly, then the – or + button to set the time you want. The ⏰ symbol and time set are displayed. The minute timer displays the countdown in minutes and seconds, or hours and minutes.
- To check the time of day during the running of the minute timer, briefly press the – + buttons together.
- To cancel the timer, reset the time to 0.00 by pressing the – button.
- When the time is up, the timer will beep. Press the – or + button to turn the timer off.

Adjusting the volume of the timer

You can choose between three levels of volume for the timer beeps.

To adjust the volume:

- 1 Check the clock is set and the timer is not running.
- 2 Press and hold the – button. The timer will beep.
- 3 Release the – button and re-press to hear the next level of volume. The last level selected is stored.

Note: if the power to the oven is cut, then the 'beep' volume will reset to the loudest level.

Electronic clock models (E, ED, CTE)



Timer



Cook time is used for automatic cooking. The oven will automatically turn off at the end of the set cook time.



Stop time is used for automatic cooking.



Manual returns the oven to manual control during automatic cooking or when automatic cooking is completed, and is used for setting the clock.





Symbols are used for changing times in the selected mode.



Fig.5 Electronic clock











Setting the clock

To set the clock, press the  button once and then press the  or  button until the clock shows the correct time.

Note: AUTO will appear in the clock display while the  button is being pressed.

Using the timer



You can use the timer at any time, even when the oven is not in use. The timer does not turn the oven off.

- To set the timer, press the  button briefly, then the  or  button to set the time you want. After a few seconds, the clock will show the time of day with the  symbol in the display.
- To check the remaining time press the  button.
- To cancel the timer, press the  button and then reset the time to 0:00 by pressing the  and  buttons. Press the  button to turn the timer off.
- When the time is up, the timer will beep. Press the  button to turn the timer off.

Adjusting the volume of the timer

You can choose between three levels of volume for the timer beeps.

To adjust the volume:

- 1 Check the clock is set and the timer is not running.
- 2 Press and hold the  button. The timer will beep.
- 3 Release the  button and re-press to hear the next level of volume. The last level selected is stored.

Note: if the power to the oven is cut, then the 'beep' volume will reset to the loudest level.

Your oven has a variety of cooking functions to suit your needs (not all models have the entire range of cooking functions). Depending on which model you have, your oven will have either a ringer timer, or function and temperature control knobs.

Note: the oven cooling fan comes on automatically at different stages of the cooking cycle. It blows out warm air above the door. When the oven is turned off, the cooling fan may stay on until the oven cools down.

Ringer timer model (R)

The ringer timer model has two cooking functions: Bake (between 'LO' and 'HI') and Grill.

- To turn the oven on to Bake, simply turn the temperature control knob clockwise to the required temperature. The oven light will come on automatically while the oven is in use. The oven indicator light will glow until the oven has reached the set temperature.
- When you have finished cooking, turn the temperature control knob to Off.
- For grilling, turn the temperature control knob to Grill.

Control knob models (C, A, E, ED, CTE)

- 1 Select the function using the function control knob. The oven light/s will come on.
- 2 Select the temperature using the temperature control knob. The oven temperature indicator light will glow until the oven has reached the set temperature, and then it will go out.
- 3 When you have finished cooking, turn the function and temperature control knobs to OFF.

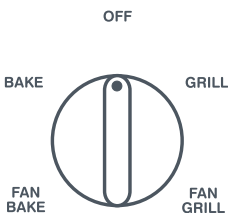

FUNCTION

Fig.6 C model

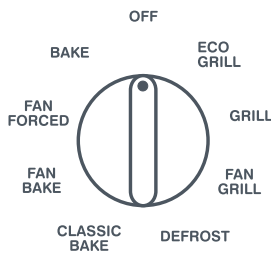

FUNCTION

Fig.7 A, E, ED and CTE models

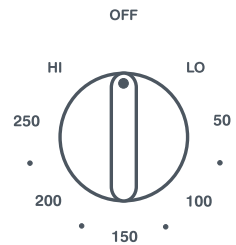

TEMPERATURE

Fig.8 C, A, E, ED and CTE models

Note: oven knobs may vary from those illustrated.

10 Cooking functions

Note: not all models have the entire range of cooking functions.



ECO GRILL Top inner element

ECO GRILL  uses the inner area of the top element and is useful when you need to grill single servings or small pieces of food. ECO grill with the door open at the first stop position.





GRILL Inner and outer top elements

GRILL  uses both of the top elements and is ideal for grilling a large area of food. Grill with the door open at the first stop position. Grilled vegetables are quick to cook and full of flavour.



FAN GRILL Fan plus top elements

FAN GRILL  circulates hot air from the top elements and is excellent for food that would normally be fried. Large cuts of meat can be cooked using this function with results similar to using a rotisserie. Use FAN GRILL  for dishes such as lasagne and moussaka. Fan-grilled whole chicken is excellent. Fan grill with the oven door closed.







DEFROST Fan only

The fan circulates air around the oven, speeding up the defrosting process by approximately 30%.





CLASSIC BAKE Bottom element

CLASSIC BAKE  uses heat from the bottom element only. Preheat the oven first on BAKE  or FAN BAKE . Use CLASSIC BAKE  for quiches, slices or anything you want browner on the bottom than on the top.





FAN BAKE Fan plus top and bottom elements

FAN BAKE  circulates hot air from the top and bottom elements. Food cooks faster than in BAKE , so you may need to lower the oven temperature by 5-10 °C. FAN BAKE  is good for crisping food, eg pastry products.





FAN FORCED Fan plus fan element

In FAN FORCED , heat from the element around the fan is forced throughout the oven. FAN FORCED  is perfect for multi-shelf cooking and batch baking, casseroles and baked potatoes.



BAKE Top and bottom elements

BAKE  is the traditional method of cooking. It is best to cook on only one shelf at a time in this function. Use BAKE  for delicate food and foods that require long cooking, eg fruit cakes, bread and roasts.

Use automatic cooking to automatically turn the oven on, cook, and then turn the oven off.

Analogue clock model (A)

To set automatic cooking:

- 1 Check the clock shows the correct time.
- 2 Select the function and temperature. The oven indicator light will glow, and the oven will come on.
- 3 Decide how long the food will take to cook, allowing time for preheating if necessary.
- 4 Turn the **COOK TIME** knob anticlockwise to show how long you need the food to cook for, eg 60 minutes (Fig. 9b).
- 5 Decide when you would like the oven to come on.

For example, if you would like the oven to turn off at 7 pm, and the cooking time is 60 minutes, you want the oven to turn on at 6 pm.

- 6 Press and turn the **START TIME** knob anticlockwise until the  triangle is pointing to the time you would like the oven to turn on, eg 6 pm (Fig. 9c).



If there is time to wait before cooking starts, the oven indicator light will go out, and the oven will switch off but is now set for automatic cooking.

If you are already at home to turn the oven on and only want the oven to turn off automatically, start cooking as normal, then follow step 4 to set a cook time. In this case the  triangle will be pointing to the current time (Fig. 9b).

When the cook time is completed, the oven will turn off and the timer will ring.

- To turn the ringer off, turn the **COOK TIME** knob anticlockwise to the  symbol.

To turn the oven off or cancel automatic cooking at any time:

- 1 Turn the **COOK TIME** knob anticlockwise to the  symbol (Fig. 9a).
- 2 Press and turn the **START TIME** knob until the  triangle clicks into alignment with the hour hand (Fig. 9a).
- 3 Turn temperature and function to OFF.

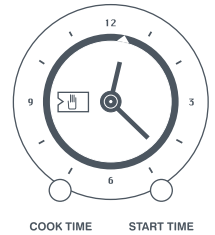

Fig.9a



Fig.9b

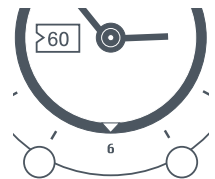







Fig.9c

*Automatic cooking
on analogue clock.*

12 Automatic cooking

Electronic clock models (E, ED, CTE)

To set automatic cooking:

- 1 Check the clock shows the correct time.
- 2 Select the function and temperature. The oven temperature indicator light will glow and the oven will come on.
- 3 Decide how long the food will take to cook, allowing time for preheating if necessary.
- 4 Press the  button. 0-00 will show. Using the   buttons, set the cooking time, eg 1 hour 15 minutes.
- 5 Select the time you would like the oven to turn off by pressing the  button and then using the   buttons eg 18-00.

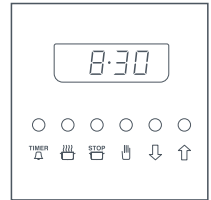

Fig.10 Electronic clock and controls





If there is time to wait before cooking starts, the current time of day and **AUTO** will show in the clock display. The oven temperature indicator light will go out and the oven will switch off but is now set for automatic cooking.





Fig.11 Sample cook time shown

If you are already at home to turn the oven on and only want the oven to turn off automatically, start cooking as normal, then follow step 5 to set a time to stop the oven.

When automatic cooking starts, **AUTO** will be displayed and the oven will turn on.

- To see the remaining cook time, press the  button.
- To see the set stop time, press the  button.
- To cancel automatic cooking at any time, press the  button and turn the temperature and function knobs to the off  position.

When the stop time is reached, the oven will turn off, the timer will beep and **AUTO** will flash:

- Press the  button to stop the beeping and return the oven to manual mode.
- Turn the temperature and function knobs to the off  position.

Important!

Safe food handling: leave food in the oven for as short a time as possible before and after cooking. This is to avoid contamination by organisms which may cause food poisoning. Take particular care during warmer weather.

Shelf positions

Shelf positions are numbered from the top down. The top positions are for grilling functions and middle shelves are suitable for baking and roasting. Do not cook or place anything on the oven floor.

Shelf supports

The shelf supports hold the wire shelves and the grill/roast pan.

Important!

- For all shelf positions (unless your oven is supplied with shelf slides on position 7) make sure you fit shelves and the grill/roast pan between the metal runners of the shelf supports, as shown in Fig.12.
- The oven shelves and the grill/roast pan have a 'stop notch' so that you do not accidentally pull them right out of the oven. Make sure you put the stop notch towards the back of the oven, as shown in Fig.13.
- Do not place aluminium foil or dishes with reflective qualities on the oven floor as this will cause a heat build-up which will irreversibly damage the enamel.

Shelf slides

Shelf slides in shelf position 7 give easy access to the most commonly used shelf position for baking and roasting. The shelf slides can hold the wire shelves and the grill/roast pan.

Note: shelf slides are not supplied with every model.

Step-down shelf

The step-down oven shelf increases shelving flexibility and maximises the useable space in the oven. Using the step-down shelf in the bottom shelf position is excellent for quiches and pastry tarts.

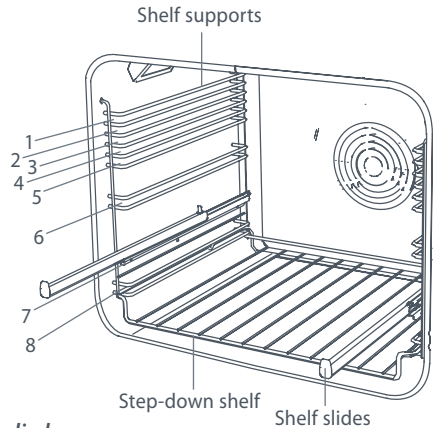

Fig. 12 Shelf positions

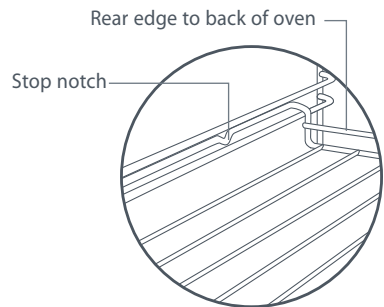

Fig. 13 Location of stop notch

Baking tray

The baking tray is suitable for biscuits and baked goods.

Three-piece grill/roast system

The three-piece grill/roast system (made up of the pan, grid and rack) is designed to give superior cooking results and to prevent hot fat and juices in the pan splattering throughout the oven. All pieces can be used together as one complete unit, or in different combinations.

Note: not all accessories are supplied with every model.

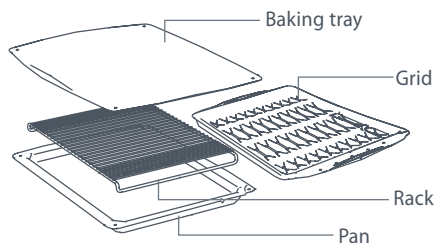







Fig. 14 Accessories

Celsius (°C)	Fahrenheit (°F)	Gas Mark	
110	225	¼	Cool
130	250	½	
140	275	1	
150	300	2	Moderately cool
170	325	3	
180	350	4	Moderate
190	375	5	
200	400	6	Moderately hot
220	425	7	
230	450	8	Hot
240	475	9	Very hot

This chart will help you to match your cooking requirements to the most appropriate cooking function.

Key: ● Recommended method
○ Alternative method

	BAKE 	FAN FORCED 	FAN BAKE 	CLASSIC BAKE 	GRILL 	FAN GRILL 
Baked products						
Biscuits- single tray	○	○	●			
Biscuits- 2-3 trays	○	●	○			
Slices	○	○	●	○		
Butter cake	○	○	●			
Fruit cake	●	○	○			
Sponge	●	○	○			
Meringues	●	○	○			
Scones	○	○	●			
Muffins	○	○	●			
Pastry						
Filo parcels / Apple pie	○	○	●			
Lemon meringue pie	○	○	●	○		
Quiche	○	○	○	●		
Meats						
Beef - roast	●	○	○			○
Beef - steak					●	
Lamb - roast	○	○	○			●
Lamb - rack			○		○	●
Pork - roast	○	○	○			●
Poultry						
Chicken - whole	○	○	○			●
Chicken - pieces	○	○	○			●
Savoury dishes						
Casseroles	●	○	○			○
Lasagne	○	●	○			○
Complete oven meals and reheating precooked food		●				

Compact oven

The compact oven can be used in the same way as a full sized oven because it is fully featured.

As the oven is smaller, use shelves 1 & 2 for grilling, and shelves 3 & 4 for baking.

Food may need to be cooked at a lower temperature (approximately 5-10 °C) or for a shorter time (approximately 10%).

Grilling

For many meats grilling is considered to be a healthier option than frying. Recently, grilling has also become a popular way to cook vegetables.



Tips for successful grilling



GRILL and





ECO GRILL

- Preheat the grill for five minutes before using it.
- Grill with the oven door open at the first stop-position.
- Place food on the three-piece grill/roast system, and slot it into one of the upper shelf positions (see the 'Grilling chart' for the most appropriate shelf).
- The higher you place the food, the faster it will cook and brown.
- The higher the temperature, the faster the food will cook and brown, and we recommend you grill at high temperatures. However, you can use lower temperatures.
- Grill only on one shelf at a time.
- Use ECO GRILL  for smaller portions of food.
- In ECO GRILL , place the food on the middle of the grill rack in the three-piece grill/roast system (where the metal bars are further apart).



FAN GRILL

- You do not need to preheat the grill.
- Use FAN GRILL  with the oven door closed. The top elements cycle on and off, and the fan circulates the hot air. The thermostat maintains the oven temperature.
- Use FAN GRILL  for foods you might otherwise pan fry, barbeque or rotisserie, and for larger cuts of meat. It's also good for dishes like lasagne and moussaka.
- Place food on the three-piece grill/roast system, and slot it into one of the middle or lower shelf positions (see the 'Grilling chart' for the most appropriate shelf).

Grilling chart

Food	GRILL/ECO GRILL			FAN GRILL		
	Shelf	Temp	Time (mins)	Shelf	Temp °C	Time (mins)
Beef						
Steak - rare	3	High	8-10			
Steak - medium	4	High	10-15			
Steak - well done	4	High	15-20			
Hamburgers - well done	4	High	12-15	5	180-200	15-20
Meatballs - well done	4	High	12-15	5	180-200	15-25
Lamb						
Chops - medium	4	High	15-20	4	180-200	15-20
Chops - well done	4	High	20-25	4	190-200	20-25
Rack - medium				6	190-200	25-35
Pork						
Chops - well done	4	High	15-20	5	180-200	20-30
Ham steaks - well done	4	High	10-15	5	180-200	15-20
Bacon - well done	3	High	6-8	4	180-200	10-15
Sausages						
Well done	4	High	10-15	5	180-200	15-25
Chicken						
Pieces - well done				5	180-200	15-30
Whole - well done				7	175	30-35 per 500 g
Fish						
Fillets - thick	4	High	8-12	4	180-200	8-12
Fillets - thin	4	High	6-10	4	180-200	6-10
Toast						
3-6 slices - medium	1	High	2-3			
1-2 slices - medium	1	High	2-3			

continued...

Grilling chart continued...

Food	GRILL/ECO GRILL			FAN GRILL		
	Shelf	Temp	Time (mins)	Shelf	Temp °C	Time (mins)
Family favourites						
Fruit crumble				7	150-160	30-40
Macaroni cheese				7	175-180	20-25
Lasagne				7	150-160	25-30
Moussaka				7	150-160	30-35
Cannelloni				5	150-160	25-30
Vegetables				5	175-200	20-30
Snacks						
Cheese on toast				2	High	4-5
Nachos				4	175	10-15









This chart refers to shelf positions in the full-sized oven.

The above temperatures and times are a guide only and you may need to increase or decrease them depending on your preferences.

Baking

Your built-in oven gives you an outstanding choice of baking options (see 'Cooking functions').

Tips for successful baking

- Preheat the oven while you prepare your food – many baked items should not be left long before baking.
- Read the recipe and assemble the ingredients on the bench before you start.
- Use baking paper to line cake pans and biscuit trays, to eliminate the need for greasing.
- See the 'Baking chart' for suggested times, temperature and shelf positions.
- For best results use the trays supplied with your oven.
- Some foods are best cooked on a particular function (see the 'Cooking function options' chart).
- FAN BAKE  is great for pastry products such as apple pie and anything that takes less than an hour to cook.
- When using FAN BAKE  for a recipe that only gives instructions for BAKE  you need to lower the oven temperature slightly (approximately 5-10 °C) and/or reduce the cooking time a little (approximately 10%).
- FAN FORCED  is the best function for cooking on more than one shelf at a time. Space the shelves evenly in the oven so the hot air can circulate freely.
- Bread and rich fruitcakes are best cooked on BAKE . If two shelves of baking are cooked on this function swap them over towards the end of the cooking time (that is, move the upper tray to the lower position and the lower tray to the upper position) so both brown evenly.
- Always place baking pans centrally on the oven shelf. If cooking more than one pan on a shelf, space them evenly so the hot air can circulate freely around them. If the pans are large, it may be necessary to swap them around towards the end of the cooking time.
- CLASSIC BAKE  uses heat from the bottom element only and is perfect for foods with a pastry base such as custard tarts, baked cheesecakes and quiches or anything that doesn't need to be browned on top. Preheat the oven on FAN FORCED  before switching function to CLASSIC BAKE .

Important!

Some recipes recommend putting water or ice in the oven with bread dough during baking. The additional moisture improves the bread crust. You must place the water or ice in a dish on an oven shelf. Do not put it directly onto the oven floor. Placing water, ice, or any dish or tray directly on the oven floor can irreversibly damage the enamel.

Baking chart

Food	BAKE		
	Shelf	Temp °C	Time (mins)
Baked products			
Biscuits	6	170-180	10-15
Slices	7	160-175	20-30
Shortbread	6	135-145	25-35
Cake - butter/choc	7	150-170	55-75
Cake - fruit light	7	150-160	70-90
Cake - fruit rich	7	135-150	4-6 hrs
Sponge	7	170-190	25-35
Muffins	6	200-220	12-18
Meringues	7	110-120	55-65
Scones	6	200-220	10-15
Bread/Rolls	7	190-220	15-30
Pizza	7	225-250	12-20
Apple pie	8	175-190	25-35
Pastry			
Filo	7	175-190	30-35
Flaky/Puff	7	210-225	10-20
Choux	7	185-210	35-45
Quiche	7	180-200	20-30
Bacon & egg pie	7	180-200	35-45
Custard tart - pastry case	7	180-200	14-18
Custard tart - filling	7	180 → 120	7 → 20-25
Lemon meringue pie - pastry case	7	180-200	14-18
Lemon meringue pie - filling	7	170-180	15-20
Family favourites			
Lasagne	7	170-180	35-45
Meatloaf	7	175-190	60-70
Chicken pieces	7	175-180	45-50
Chicken casserole	7	175-190	50-65
Fish pie	7	175-190	25-30
Complete oven meal*	-	-	-
Vegetables			
Baked	7	160-180	45-70
Roasted	7	175-200	30-45

*Complete oven meal example: 1.5 kg roast lamb, 800 g potatoes, 400-500 g root vegetables & fruit pie. Depending on the size of the meat and weight of vegetables, cooking times will vary.

→ Two-stage baking process - adjust temperature after the first stage.











Download from [Www.Somanuals.com](http://www.Somanuals.com). All Manuals Search And Download.

FAN BAKE			FAN FORCED		
Shelf	Temp °C	Time (mins)	Shelf	Temp °C	Time (mins)
6	160-175	8-12	5, 7	170-180	10-15
7	150-170	20-30	7	160-175	20-30
6	125-235	20-30	6	135-145	20-30
7	150-160	45-65	7	150-170	55-75
7	140-150	60-80	7	145-155	80-100
7	125-145	4-6 hrs	7	130-150	4-6 hrs
7	160-175	20-30	7	170-190	25-35
6	190-200	12-16	6	200-220	12-18
7	100-110	50-60	5, 7	110-120	55-65
6	190-210	8-12	6	190-210	10-12
7	180-210	15-25	7	190-210	15-30
7	200-230	12-18	7	225-250	15-20
8	175-190	25-30	7	180-200	25-30
7	160-175	25-30	7	175-190	30-35
7	200-220	10-20	7	210-225	10-20
7	175-200	30-40	7	185-210	35-45
7	170-190	20-30	7	180-200	20-30
7	170-190	30-40	7	180-200	35-45
7	175-195	12-16	7	180-200	14-18
7	170 → 110	7 → 20-25	7	180 → 120	7 → 20-25
7	175-195	12-16	7	180-200	14-18
7	165-175	10-15	7	170-180	15-20
7	150-160	35-45	7	160-170	35-45
7	170-180	50-60	7	175-190	60-70
7	155-170	45-50	7	175-180	45-50
7	150-165	45-60	7	170-180	45-60
7	170-180	20-30	7	175-190	25-30
-	-	-	4, 8	160	90-100
7	160-175	45-70	7	160-180	45-70
7	175-190	30-45	7	175-200	30-45

Roasting

Your built-in oven is equipped to handle a variety of roasts.

Tips for successful roasting

- When cooking large cuts of meat, times and temperatures are based on 30 minutes per 500 g/1 lb. Times and temperatures given below are guidelines and small adjustments may be necessary.
- Roasting times will be affected by the shape, size and temperature of the meat being roasted.
- Meat with a bone will cook more quickly than a boneless roast.
- Do not add water to your roast, as this steams the meat.
- For perfect results, use a meat probe or a meat thermometer.
- Let all roast meats and poultry stand for 10-15 minutes at the end of cooking before carving. This allows the meat fibres to relax. Fewer juices will be lost when it is cut and the meat will be juicier and more tender. To keep the meat warm, cover with foil.
- The meat will continue to cook during standing, so allow for this in your calculations (this is particularly important if you want a rare or medium rare roast).
- Roasting can be achieved with a range of cooking functions. FAN BAKE , FAN FORCED , BAKE  and FAN GRILL  can all be used for roasting, each giving unique results.
- Meats roasted on FAN GRILL  cook and brown in a rotisserie style. Radiant heat sears the outside surface while the inside remains tender and juicy. You do not need to preheat the oven on FAN GRILL .
- BAKE  is the traditional function for roasting. Cook one tray at a time.
- FAN FORCED  is perfect for roasting when you also need to cook other dishes on another shelf position.
- FAN BAKE  tends to brown and cook faster than BAKE .

Roasting chart

Food	Shelf	Temp °C	Mins/500 g	Internal temp °C
Meat				
Beef - rare	7	160-170	30-35	50-60
Beef - medium	7	160-170	35-45	65-70
Beef - well done	7	160-170	45-60	75-80
Mutton - well done	7	160-170	45-60	75-80
Hogget - medium	7	160-170	30-40	65-70
Hogget - well done	7	160-170	45-60	75-80
Pork - well done	7	180-185	40-45	75-80
Chicken - well done	7	160-180	25-30	82-85
Venison* - rare	7	220	3.5 per cm thickness	50-60

* Brown prior to roasting in an oiled frypan on high heat.

Cleaning the outside of the oven

Important!

Do not use abrasive cleaners or a steam cleaner on the outside surfaces of the oven.

Before cleaning the outside of your oven, we recommend you turn the oven off at the wall. Wipe the oven's outside surfaces often, using warm water and a household detergent and/or a stainless steel cleaner and polish.

Cleaning the inside of your oven

Important!

Before you start cleaning inside your oven, please:

- *Read these cleaning instructions and the 'Safety and warnings' section at the start of this guide.*
- *Turn the oven off at the wall.*
- *Make sure the oven is a safe temperature to touch.*

Do not use a steam cleaner to clean the inside of the oven.

Do not use any oven cleaners, abrasive cleaners, ammonia-based cleaners or detergents on the self-cleaning oven liners. See 'Caring for the self-cleaning liners'.

It is easier to clean the oven while it is still warm, using household detergents or an ammonia-based cleaner. You may use 'off the shelf' oven cleaners, if you carefully follow the manufacturers' instructions.

To make cleaning easier, you can remove the wire shelf supports, the oven door, and the fan cover. The top element also drops down to make cleaning the oven roof easier.

Removing and replacing the oven door

- 1 To remove the oven door, open the door fully, lift the clips (C) back towards you onto the hooks (A).
- 2 Raise the door slightly, holding it on either side near the handle, Make sure the clips stay on the hooks (A) and lift the door out.
- 3 To put the door back on, place the upper hinge arm (B) in the upper slot and the lower hinge arm (D) in the lower slot. Push the hinge arms in as far as they will go until the slot in the lower arm locates in the hinge support.
- 4 Lower the door gently and release the clips.
- 5 Raise the door slightly to make sure the clips are released from the hooks. Close the door.

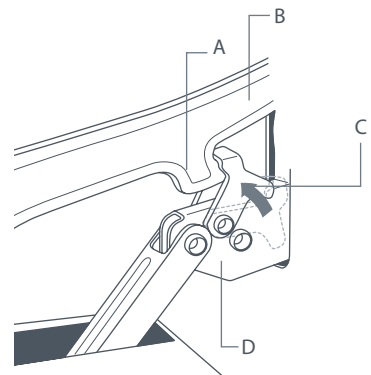

- A. Hook
- B. Upper hinge arm
- C. Clip
- D. Lower hinge arm

Fig.15 Removing the oven door

Removing and replacing the oven lamp

Always turn the oven off at the wall before touching an oven lamp. To clean the oven more easily, pull off the glass cover. If you need to replace the light, simply unscrew it.

Removing and replacing the shelf supports

- 1 Push the shelf slides in position 7 back into the oven.
- 2 To remove the shelf supports gently push the retaining wire from underneath the stud then swing the lowest edge of the shelf support up and out towards the centre of the oven. The prongs at the top will slide out.
- 3 To replace the shelf support, hold them horizontally and locate the prongs into the small slots at the top of oven cavity.
- 4 Lower the shelf support and gently place the retaining wire underneath the stud.

Important!

To avoid chipping the enamel – do not lower the shelf supports until the prongs are fully inserted into the small slots at the top of the oven.

Cleaning the shelf slides

Important!

Do not wash the shelf slides in the dishwasher. Do not immerse them in soapy water, or use oven cleaner on them. Removing the 'white' lubricating grease will reduce the life of the shelf slides and prevent them from running smoothly.

Wipe the shelf slides with a damp cloth and a mild detergent only. Do not wipe off or wash away the 'white' lubricating grease (you can see this when the slides are extended).

Note: shelf slides are not supplied with every model.

Caring for the self-cleaning liners

Self-cleaning liners are supplied with some models of the built-in oven. They help reduce manual oven cleaning. The liners are coated with a special enamel which is porous and contains oxidising catalysts.

Any grease and dirt coming into contact with the liner is absorbed by the enamel and is broken down with the help of the oxidising catalysts at normal cooking temperatures.

As cleaning is improved by using a high temperature, it may be necessary to occasionally run the empty oven on FAN GRILL  at 200 °C for 1 to 1½ hours.

Note: self-cleaning liners are not supplied with every model.

26 Ceramic cooktop (CTE)

The ceramic cooktop is made from glass ceramic, a tough material which is not affected by changes in temperature.

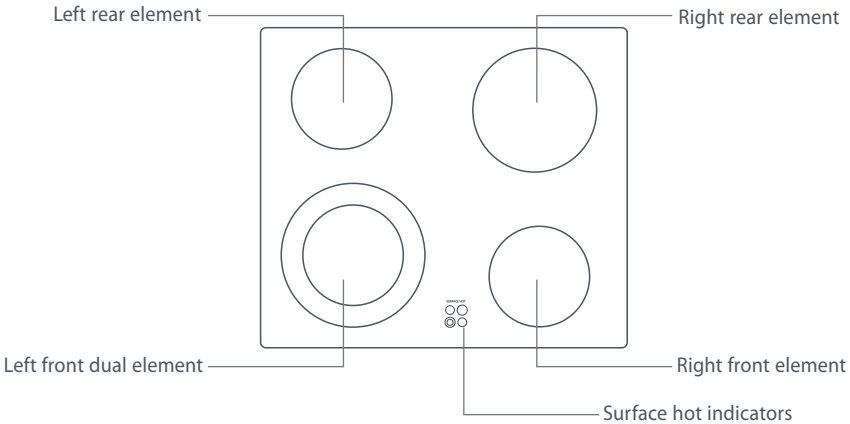

Fig.16 Ceramic cooktop

Elements

Your cooktop has four individual elements, one of which is a dual circuit element. The diameters of the cooking area are clearly marked.

The elements become red when turned on full. Corresponding hot surface indicator lights glow on the control area.

Temperature limiters are fitted to the elements to prevent the glass from overheating. The limiters will turn the elements on and off during cooking to maintain the temperature that has been set.

Controls

The controls on the underbench oven are 'push and turn' as a safety feature to deter children from turning the cooktop on.

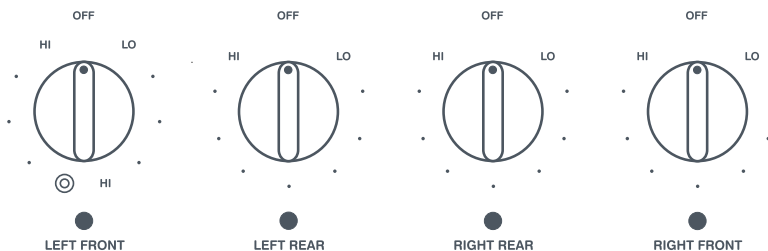

Fig.17 Cooktop controls

Surface hot indicator lights

The surface hot indicator lights are marked on the ceramic glass. The indicator lights will glow when the glass above an element is hot. They will continue to glow after the element has been turned off until the glass has cooled to a temperature that is safe to touch.

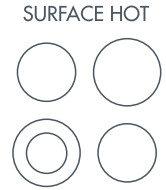

Fig.18 Surface hot indicator lights

Dual element control

The left front element can be adjusted from a small inner element, to a full element.

- To heat the entire element, push and turn control anticlockwise to Hi.
- To heat inner part only, push and turn control clockwise to Hi.

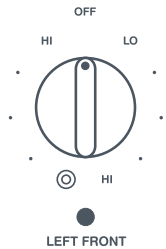

Fig.19 Dual element control

Cookware

To get the best results out of your cooktop follow these simple suggestions:

- Use heavy-gauge, flat, smooth bottom pans that conform to the diameter of the cooking area. This will provide good contact with the glass and help reduce cooking times.
- Cookware with a stainless steel sandwich base or enamelled cast iron will give you the best results.
- When food comes to the boil reduce the temperature setting.
- Never use plastic or aluminium foil dishes on the cooktop.
- Aluminium and copper-bottomed cookware can cause a metallic residue to remain on the cooktop. If left, this becomes difficult to remove. Clean the cooktop after every use.
- Jagged edges on saucepans or heavy frypans will scratch the cooktop.
- Using a lid will reduce cooking times.



Fig.20 Efficient and inefficient pan bases

Cleaning the ceramic glass cooktop

To clean your cooktop:

- 1 Remove baked-on spills while they are still warm, using the razor blade scraper supplied.
- 2 Wipe clean with a damp, soapy cloth.
- 3 Allow to cool, then apply ceramic glass cooktop cleaner to soiled areas.
- 4 Rub vigorously with a clean soft cloth or paper towel.
- 5 Wipe over with a damp cloth to remove any food or cleaner residue. The cooktop may become stained if any of the cleaner is left on the cooktop.
- 6 Apply ceramic glass cooktop polish sparingly, and rub well with a clean soft cloth or paper towel to ensure the whole cooktop surface is covered.
- 7 Polish with a clean, dry, soft cloth.

Important!

- *Do not use abrasive sponges, or corrosive cleaners such as oven sprays and stain removers.*
- *When the safety cover is retracted the blade in the scraper is razor-sharp. Use with extreme care and always store safely and out of reach of children.*

Spillovers that require immediate attention

Anything that MELTS on the ceramic surface, or food spillovers with a high sugar content, may cause pitting on the ceramic cooktop if they are left to cool there.

Clean these listed spillovers immediately using the provided razor blade scraper. Do not let them cool on the cooktop.

- Melted plastics
- Plastic wrap
- Melted aluminium foil
- Sugar
- Sugar syrup
- Jam
- Vegetables with a high sugar content, eg peas and beetroot

Clean and polish the cooktop after every spill. The polish protects the ceramic as it helps to prevent spills bonding to the surface.

Metallic stains

Copper-based or aluminium saucepans may cause metallic staining. These stains show as a metallic sheen on the cooktop. If the cooktop is not cleaned regularly and the stains are allowed to burn into the surface, they may react with the ceramic glass and will no longer be removable. Apply a ceramic glass polish after every use to help protect against stains.

Before you call for service or assistance ...

Check the things you can do yourself. Refer to the installation instructions and your user guide and check that:

- 1 Your product is correctly installed.
- 2 You are familiar with its normal operation.

If after checking these points you still need assistance, please refer to the Service & Warranty book for warranty details and your nearest Authorised Service Centre, or contact us through our website:

www.fisherpaykel.com

Copyright © Fisher & Paykel 2006. All rights reserved.

The product specifications in this booklet apply to the specific products and models described at the date of issue. Under our policy of continuous product improvement, these specifications may change at any time. You should therefore check with your Dealer to ensure this booklet correctly describes the product currently available.

www.fisherpaykel.com

NZ AU

Built-in oven user guide

Published: 05/2006

Part No. 542630 A

Free Manuals Download Website

<http://myh66.com>

<http://usermanuals.us>

<http://www.somanuals.com>

<http://www.4manuals.cc>

<http://www.manual-lib.com>

<http://www.404manual.com>

<http://www.luxmanual.com>

<http://aubethermostatmanual.com>

Golf course search by state

<http://golfingnear.com>

Email search by domain

<http://emailbydomain.com>

Auto manuals search

<http://auto.somanuals.com>

TV manuals search

<http://tv.somanuals.com>