

User guide

Galaxy drop-in cooking system

DI1203 models

NZ AU GB IE

Introduction	2
Safety and warnings	3
Clock and timer	5
Operating the oven	7
Cooking functions	8
Automatic cooking	9
Oven shelves	10
Accessories	11
Oven temperature conversion chart	12
Cooking function options	13
Cooking charts	14
Galaxy cooktop/hob	22
Care and cleaning	26
Warranty and service	29
Gas rate summary - NZ AU	30
Gas rate summary - EU	31

Important!

SAVE THESE INSTRUCTIONS

Download from [Www.Somanuals.com](http://www.Somanuals.com). All Manuals Search And Download.

2 Introduction

About your new Galaxy drop-in cooking system

Thank you for buying a Fisher & Paykel Galaxy. Now that it is installed and ready to use, you will want to know everything about it to make sure you get excellent results right from the start. This guide introduces you to all its features, as well as giving you a comprehensive set of cooking charts. We recommend you read the whole guide before using your new Galaxy, for both safety and cooking success.

Before using your new Galaxy

Before using your new Galaxy, please:

- Read this user guide, taking special note of the 'Safety and warnings' section following.
- Remove all accessories and packaging.
- Set the clock. The oven will not work until the clock has been set. See the 'Clock and timer' section.
- Condition the oven by turning the function knob to FAN BAKE  and the temperature knob to 200 °C and heat for one hour.

There will be a distinctive smell while you are conditioning your oven. This is normal, but make sure your kitchen is well ventilated during the conditioning.

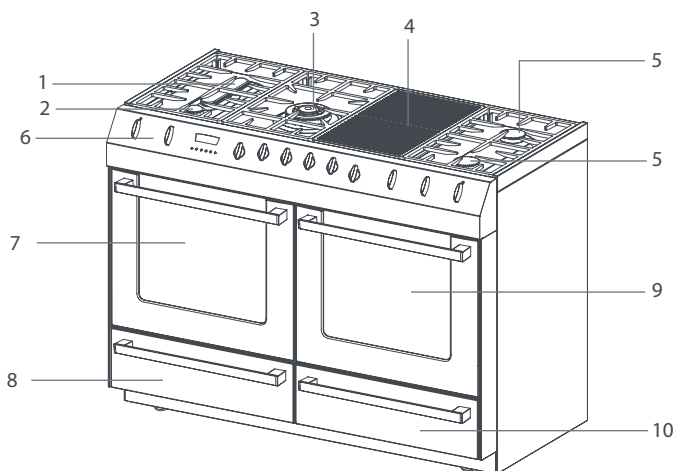

Fig.1 DI1203

- | | | | |
|---|--------------------|----|---------------------------|
| 1 | Griddle burner | 6 | Control panel |
| 2 | Auxilliary burner | 7 | Left-hand oven |
| 3 | Wok burner | 8 | Left-hand storage drawer |
| 4 | Electric barbeque | 9 | Right-hand oven |
| 5 | Semi-rapid burners | 10 | Right-hand storage drawer |

Your Galaxy has been carefully designed to operate safely during normal cooking procedures. Please keep the following guidelines in mind when you are using your Galaxy:

⚠ WARNING!



Hot Surface Hazard

Accessible parts will become hot when this oven is in use.
Accessible parts may become hot when the grill is in use with the door open.
To avoid burns and scalds keep children away.
Do not touch hot surfaces inside the oven.
Use oven mitts or other protection when handling hot surfaces such as oven shelves or dishes.
Take care when opening the oven door.
Let hot air or steam escape before removing or replacing food.
Do not touch the cooktop components, burners, trivets/pan supports or the stainless steel base when hot.
Before cleaning, turn the burners off and make sure the whole cooktop is cool.
Failure to do so could result in burns and scalds.

⚠ WARNING!



Electrical Shock Hazard

Switch the oven off at the wall before replacing fuses or the oven lamp.
Failure to do so may result in death or electrical shock.

⚠ WARNING!



Explosion Hazard

Do not store flammable materials such as gasoline near the cooktop.
Do not spray aerosols near the cooktop during use.
Failure to do so may result in death or electrical shock.

Important safety precautions

- *Isolating switch: make sure this oven is connected to a circuit which incorporates an isolating switch providing full disconnection from the power supply.*
- *Household appliances are not intended to be played with by children.*
- *Children, or persons with a disability which limits their ability to use the appliance, should have a responsible person to instruct them in its use. The instructor should be satisfied that they can use the appliance without danger to themselves or their surroundings.*
- *Safe food handling: leave food in the oven for as short a time as possible before and after cooking. This is to avoid contamination by organisms which may cause food poisoning. Take particular care during warmer weather.*
- *Do not place aluminium foil or dishes with reflective qualities on the oven floor as this will cause a heat build-up which will irreversibly damage the enamel.*
- *Do not stand on the door, or place heavy objects on it.*
- *Do not use abrasive cleaners on the outside surfaces of the oven.*
- *Do not use a steam cleaner to clean any part of the oven.*
- *Do not stand or place heavy objects on this appliance.*
- *Do not use an asbestos mat or decorative covers between the flame and the saucepan as this may cause serious damage to your cooktop.*
- *Do not place aluminium foil or plastic dishes on the cooktop burners.*
- *Do not let large saucepans or frying pans overlap the bench as this can deflect heat onto your benchtop and damage the surface.*
- *Do not let large saucepans, frying pans or woks push any other pans aside. This could make them unstable or deflect heat onto your benchtop and damage the surface.*
- *Do not use a steam cleaner for cleaning this cooktop.*
- *Saucepan handles may be hot to touch. Ensure saucepan handles do not overhang other gas burners that are on. Keep handles out of reach of children.*
- *If the electrical supply cord is damaged, it must only be replaced by an authorised person. Ensure that the electrical connection plug is accessible after installation.*
- *Where this gas cooktop is installed in marine craft or in a caravan, it shall not be used as a space heater.*
- *The use of a gas cooking appliance results in the production of heat and moisture in the room in which it is installed. Ensure the kitchen is well ventilated. Keep natural ventilation holes open or install a mechanical ventilation device (mechanical extractor hood). Prolonged intensive use of the appliance may call for additional ventilation, for example opening of a window, or more effective ventilation, for example increasing the level of mechanical ventilation where present.*
- *Only use the griddle on the fish burner.*
- *To prevent excessive heat build up in the cooktop area, cooking times on the griddle should be limited to 1 hour.*
- *The barbeque cover (accessory) must not be used as a cooking surface.*
- *Fat left on the lava rocks or in the tray may ignite. If flame flare-ups become excessive during cooking turn down the temperature. The barbeque grid, rock tray and lava rocks should be cleaned after every use.*

 **Timer**

 **Cook time** for automatic cooking.
The oven will automatically turn off at the end of the set cook time.

 **Stop time** for automatic cooking.

 **Manual** returns the oven to manual control during automatic cooking or when automatic cooking is completed, and for setting the clock.

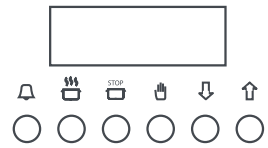







Fig.2 Electronic clock

  **Symbols** are used for changing times in the selected mode.











Setting the clock

To set the clock, press the  button once and then press the  and  buttons until the clock shows the correct time.

Note: AUTO will appear in the clock display while the  button is being pressed.

Using the timer



You can use the timer at any time, even when the oven is not in use. The timer does not turn the oven off.

- To set the timer, press the  button briefly, then the  and  buttons to set the time you want. After a few seconds, the clock will show the time of day with the  symbol in the display.
- To check the remaining time press the  button.
- To cancel the timer, press the  button and then reset the time to 0:00 by pressing the  and  buttons. Press the  button to turn the timer off.
- When the time is up, the timer will beep. Press the  button to turn the timer off.

Adjusting the volume of the timer

You can choose between three levels of volume for the timer beeps.

To adjust the volume:

- 1 Check the clock is set and the timer is not running.
- 2 Press and hold the  button. The timer will beep.
- 3 Release the  button and re-press to hear the next level of volume. The last level selected is stored.

Note: if the power to the oven is cut, then the 'beep' volume will reset to the loudest level.

6 Clock and timer

Using the manual timer (right hand oven only)

The timer can be used at any time, even when the right hand oven is not in use. If the right hand oven is in use, the timer will ring and turn the oven off when the selected time has elapsed. The timer can be set for up to 120 minutes.

To set the timer

Turn the timer control clockwise to the 120 minute mark, then turn back to show the number of minutes you require.

To cancel the timer

Turn the timer control to the 'O' mark.

- 1 Select the function using the function control knob. The oven lights will come on.
- 2 Select the temperature using the temperature control knob. The oven temperature indicator light, above the temperature knob on the control panel, will glow until the oven has reached the set temperature, and then it will go out.
- 3 When you have finished cooking, turn the function and temperature control knobs to the off **O** position.

Note: the oven cooling fan comes on automatically at different stages of the cooking cycle. It blows out warm air above the door. When the oven is turned off, the cooling fan may stay on until the oven cools down.

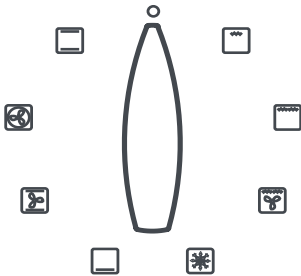

Fig.3 Function control knob

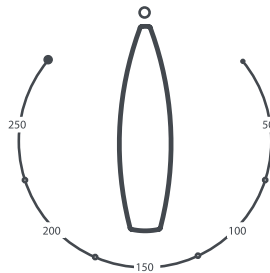

Fig.4 Temperature control knob

Note: oven knobs may vary from those illustrated.

Cooking functions

Your oven has eight cooking functions. Each function is represented by a symbol on the oven control panel.



ECO GRILL Top inner element

ECO GRILL  uses the inner area of the top element and is useful when you need to grill single servings or small pieces of food. For best results leave the door open at the first stop position.





GRILL Inner and outer top elements

GRILL  uses both of the top elements and is ideal for grilling a large area of food. For best results leave the door open at the first stop position. Grilled vegetables are quick to cook and full of flavour.



FAN GRILL Fan plus top elements

FAN GRILL  circulates hot air from the top elements and is excellent for food that would normally be fried. Large cuts of meat can be cooked using this function with results similar to using a rotisserie. Use FAN GRILL  for dishes such as lasagne and moussaka. Fan-grilled whole chicken is excellent. Fan grill with the oven door closed.







DEFROST Fan only

The fan circulates air around the oven, speeding up the defrosting process by approximately 30%.





CLASSIC BAKE Bottom element

CLASSIC BAKE  uses heat from the bottom element only. Preheat the oven first on BAKE  or FAN BAKE . Use CLASSIC BAKE  for quiches, slices or anything you want browner on the bottom than on the top.





FAN BAKE Fan plus top and bottom elements

FAN BAKE  circulates hot air from the top and bottom elements. Food cooks faster than in BAKE , so you may need to lower the oven temperature by 5-10 °C. FAN BAKE  is good for crisping food, eg pastry products, and it is also the best method for heating your pizza stone.





FAN FORCED Fan plus fan element







In FAN FORCED , heat from the element around the fan is forced throughout the oven. FAN FORCED  is perfect for multi-shelf cooking and batch baking, casseroles and baked potatoes.



BAKE Top and bottom elements

BAKE  is the traditional method of cooking. It is best to cook on only one shelf at a time in this function. Use BAKE  for delicate food and foods that require long cooking, eg fruit cakes, bread and roasts.

Use automatic cooking to automatically turn the oven on, cook, and then turn the oven off.

- 1 Check the clock shows the correct time.
- 2 Select the function and temperature. The oven temperature indicator light will glow and the oven will come on.
- 3 Decide how long the food will take to cook, allowing time for preheating if necessary.
- 4 Press the  button. 0:00 will show. Using the   buttons, set the cooking time, eg 1 hour 15 minutes.
- 5 Select the time you would like the oven to turn off by pressing the  button and then using the   buttons eg 18:00.

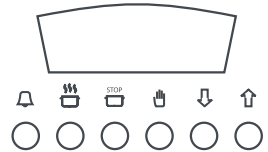

Fig.5 Oven clock and controls





If there is time to wait before cooking starts, the current time of day and AUTO will show in the clock display. The oven temperature indicator light will go out and the oven will switch off but is now set for automatic cooking. Note: the cooling fan may remain on.





Fig.6 Sample cook time shown

If you are already at home to turn the oven on and only want the oven to turn off automatically, start cooking as normal, then follow step 5 to set a time to stop the oven.

When automatic cooking starts, AUTO will be displayed and the oven will turn on.

- To see the remaining cook time, press the  button.
- To see the set stop time, press the  button.
- To cancel automatic cooking at any time, press the  button and turn the temperature and function knobs to the off  position.

When the stop time is reached, the oven will turn off, the timer will beep and AUTO will flash:

- Press the  button to stop the beeping and return the oven to manual mode.
- Turn the temperature and function knobs to the off  position.

Important!

Safe food handling: leave food in the oven for as short a time as possible before and after cooking. This is to avoid contamination by organisms which may cause food poisoning. Take particular care during warmer weather.

Shelf positions

Shelf positions are numbered from the top down. The top positions are for grilling functions and middle shelves are suitable for baking and roasting. Do not cook or place anything on the oven floor.

Shelf supports

The shelf supports hold the wire shelves, the grill/roast pan and the glass tray.

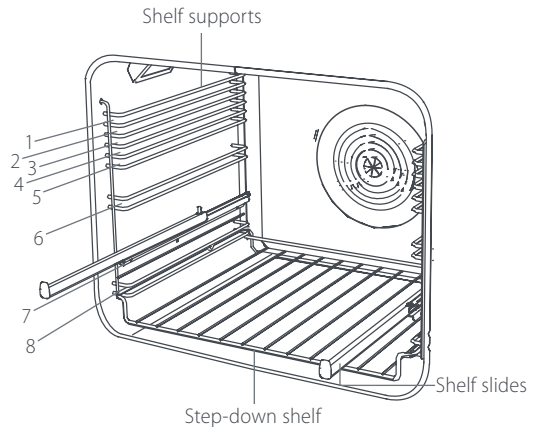

Fig. 7 Shelf positions

Important!

- For all shelf positions except 7, which has shelf slides, make sure you fit shelves, the grill/roast pan and the glass tray between the metal runners of the shelf supports, as shown in Fig.6.
- The oven shelves and the grill/roast pan have a 'stop notch' so that you do not accidentally pull them right out of the oven. Make sure you put the stop notch towards the back of the oven, as shown in Fig.7.

Shelf slides

Shelf slides in shelf position 7 give easy access to the most commonly used shelf position for baking and roasting. The shelf slides can hold the wire shelves, grill/roast pan and the glass tray.

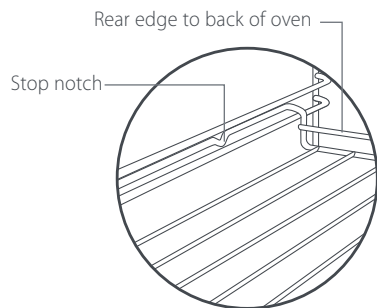

Fig. 8 Location of stop notch

Step-down shelf

The step-down oven shelf increases shelving flexibility and maximises the useable space in the oven. Using the step-down shelf in the bottom shelf position is excellent for quiches and pastry tarts.

Baking tray

The baking tray is suitable for biscuits and baked goods.

Three-piece grill/roast system

The three-piece grill/roast system (made up of the pan, grid and rack) is designed to give superior cooking results and to prevent hot fat and juices in the pan splattering throughout the oven. All pieces can be used together as one complete unit, or in different combinations.

Glass tray

The multipurpose glass tray is made from toughened glass to withstand high temperatures. It is suitable for roasting and grilling, and can also be used as a serving dish. The rim on the tray makes it easy to handle. The glass tray will not distort or corrode, and it will not shatter into small pieces if knocked.

Pizza stone and paddle

Your pizza stone will allow you to cook homemade pizza like those from an authentic pizza house, with a crispy base and moist toppings.

- To use, place the pizza stone in the oven on a wire shelf in position 7.
- Turn oven to FAN BAKE  and 200 °C or the temperature specified in your recipe and preheat for 30-45 minutes. The hotter the stone, the crisper the pizza crust will be. Mix 1-2 Tbsp of flour and 1-2 Tbsp of semolina/coarse cornmeal and sprinkle this onto the pizza paddle. This will prevent the pizza dough from sticking to the paddle when you slide the dough from your paddle onto the hot stone.

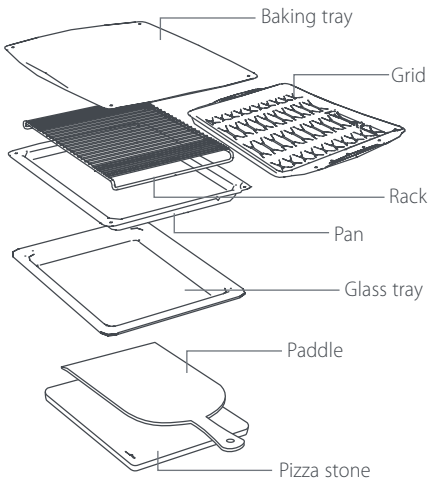







Fig. 9 Accessories

12 Oven temperature conversion chart

Celsius (°C)	Fahrenheit (°F)	Gas Mark	
110	225	¼	Cool
130	250	½	
140	275	1	
150	300	2	Moderately cool
170	325	3	
180	350	4	Moderate
190	375	5	
200	400	6	Moderately hot
220	425	7	
230	450	8	Hot
240	475	9	Very hot

This chart will help you to match your cooking requirements to the most appropriate cooking function.

Key: ● Recommended method
○ Alternative method

	BAKE 	FAN FORCED 	FAN BAKE 	CLASSIC BAKE 	GRILL 	FAN GRILL 
Baked products						
Biscuits- single tray	○	○	●			
Biscuits- 2-3 tray	○	●	○			
Slices	○	○	●	○		
Butter cake	○	○	●			
Fruit cake	●	○	○			
Sponge	●	○	○			
Meringues	●	○	○			
Scones	○	○	●			
Muffins	○	○	●			
Pastry						
Filo parcels / Apple pie	○	○	●			
Lemon meringue pie	○	○	●	○		
Quiche	○	○	○	●		
Meats						
Beef - roast	●	○	○			○
Beef - steak					●	
Lamb - roast	○	○	○			●
Lamb - rack			○		○	●
Pork - roast	○	○	○			●
Poultry						
Chicken - whole	○	○	○			●
Chicken - pieces	○	○	○			●
Savoury dishes						
Casseroles	●	○	○			○
Lasagne	○	●	○			○
Complete oven meals and reheating precooked food						
		●				

Grilling

Your Galaxy oven gives a choice of GRILL , ECO GRILL  or FAN GRILL . For many meats grilling is considered to be a healthier option than frying. Recently, grilling has also become a popular way to cook vegetables.



Tips for successful grilling



GRILL and





ECO GRILL

- Preheat the grill for five minutes before using it.
- You can grill with the oven door open slightly, at the first 'stop-position', or closed. Grilling may be slightly quicker with the oven door open. Closing the door will help to contain cooking smells and save energy.
- Place food on the three-piece grill/roast system, and slot it into one of the upper shelf positions (see the 'Grilling chart' for the most appropriate shelf).
- The higher you place the food, the faster it will cook and brown.
- The higher the temperature, the faster the food will cook and brown, and we recommend you grill at high temperatures. However, you can use lower temperatures.
- Grill only on one shelf at a time.
- Use ECO GRILL  for smaller portions of food.
- In ECO GRILL , place the food on the middle of the grill rack in the three-piece grill/roast system (where the metal bars are further apart).



FAN GRILL

- You do not need to preheat the grill.
- Use FAN GRILL  with the oven door closed. The top elements cycle on and off, and the fan circulates the hot air. The thermostat maintains the oven temperature.
- Use FAN GRILL  for foods you might otherwise pan fry, barbeque or rotisserie, and for larger cuts of meat. It's also good for dishes like lasagne and moussaka.
- Place food on the three-piece grill/roast system, and slot it into one of the middle or lower shelf positions (see the 'Grilling chart' for the most appropriate shelf).

Grilling chart

Food	GRILL/ECO GRILL			FAN GRILL		
	Shelf	Temp	Time (mins)	Shelf	Temp °C	Time (mins)
Beef						
Steak - rare	3	High	8-10			
Steak - medium	4	High	10-15			
Steak - well done	4	High	15-20			
Hamburgers - well done	4	High	12-15	5	180-200	15-20
Meatballs - well done	4	High	12-15	5	180-200	15-25
Lamb						
Chops - medium	4	High	15-20	4	180-200	15-20
Chops - well done	4	High	20-25	4	190-200	20-25
Rack - medium				6	190-200	25-35
Pork						
Chops - well done	4	High	15-20	5	180-200	20-30
Ham steaks - well done	4	High	10-15	5	180-200	15-20
Bacon - well done	3	High	6-8	4	180-200	10-15
Sausages						
Well done	4	High	10-15	5	180-200	15-25
Chicken						
Pieces - well done				5	180-200	15-30
Whole - well done				7	175	30-35 per 500 g
Fish						
Fillets - thick	4	High	8-12	4	180-200	8-12
Fillets - thin	4	High	6-10	4	180-200	6-10
Toast						
3-6 slices - medium	1	High	2-3			
1-2 slices - medium	1	High	2-3			

continued...

16 Cooking charts

Grilling chart continued...









Food	GRILL/ECO GRILL			FAN GRILL		
	Shelf	Temp	Time (mins)	Shelf	Temp °C	Time (mins)
Family favourites						
Fruit crumble				7	150-160	30-40
Macaroni cheese				7	175-180	20-25
Lasagne				7	150-160	25-30
Moussaka				7	150-160	30-35
Cannelloni				5	150-160	25-30
Vegetables				5	175-200	20-30
Snacks						
Cheese on toast				2	High	4-5
Nachos				4	175	10-15

The above temperatures and times are a guide only and you may need to increase or decrease them depending on your preferences.

Baking

Your Galaxy oven gives you an outstanding choice of baking options (see 'Cooking functions').

Tips for successful baking

- Preheat the oven while you prepare your food – many baked items should not be left long before baking.
- Read the recipe and assemble the ingredients on the bench before you start.
- Use baking paper to line cake pans and biscuit trays, to eliminate the need for greasing.
- See the 'Baking chart' for suggested times, temperature and shelf positions.
- For best results use the trays supplied with your oven.
- Some foods are best cooked on a particular function (see the 'Cooking function options' chart).
- FAN BAKE  is great for pastry products such as apple pie and anything that takes less than an hour to cook.
- When using FAN BAKE  for a recipe that only gives instructions for BAKE  you need to lower the oven temperature slightly (approximately 5-10 °C) and/or reduce the cooking time a little (approximately 10%).
- FAN FORCED  is the best function for cooking on more than one shelf at a time. Space the shelves evenly in the oven so the hot air can circulate freely.
- Bread and rich fruitcakes are best cooked on BAKE . If two shelves of baking are cooked on this function swap them over towards the end of the cooking time (that is, move the upper tray to the lower position and the lower tray to the upper position) so both brown evenly.
- Always place baking pans centrally on the oven shelf. If cooking more than one pan on a shelf, space them evenly so the hot air can circulate freely around them. If the pans are large, it may be necessary to swap them around towards the end of the cooking time.
- CLASSIC BAKE  uses heat from the bottom element only and is perfect for foods with a pastry base such as custard tarts, baked cheesecakes and quiches or anything that doesn't need to be browned on top. Preheat the oven on FAN FORCED  before switching function to CLASSIC BAKE .

Important!

Some recipes recommend putting water or ice in the oven with bread dough during baking. The additional moisture improves the bread crust. You must place the water or ice in a dish on an oven shelf. Do not put it directly onto the oven floor. Placing water, ice, or any dish or tray directly on the oven floor can irreversibly damage the enamel.

Baking chart

Food	BAKE		
	Shelf	Temp °C	Time (mins)
Baked products			
Biscuits	6	170-180	10-15
Slices	7	160-175	20-30
Shortbread	6	135-145	25-35
Cake - butter/choc	7	150-170	55-75
Cake - fruit light	7	150-160	70-90
Cake - fruit rich	7	135-150	4-6 hrs
Sponge	7	170-190	25-35
Muffins	6	200-220	12-18
Meringues	7	110-120	55-65
Scones	6	200-220	10-15
Bread/Rolls	7	190-220	15-30
Pizza	7	225-250	12-20
Apple pie	8	175-190	25-35
Pastry			
Filo	7	175-190	30-35
Flaky/Puff	7	210-225	10-20
Choux	7	185-210	35-45
Quiche	7	180-200	20-30
Bacon & egg pie	7	180-200	35-45
Custard tart - pastry case	7	180-200	14-18
Custard tart - filling	7	180 → 120	7 → 20-25
Lemon meringue pie - pastry case	7	180-200	14-18
Lemon meringue pie - filling	7	170-180	15-20
Family favourites			
Lasagne	7	170-180	35-45
Meatloaf	7	175-190	60-70
Chicken pieces	7	175-180	45-50
Chicken casserole	7	175-190	50-65
Fish pie	7	175-190	25-30
Complete oven meal*	-	-	-
Vegetables			
Baked	7	160-180	45-70
Roasted	7	175-200	30-45

*Complete oven meal example: 1.5 kg roast lamb, 800 g potatoes, 400-500 g root vegetables & fruit pie. Depending on the size of the meat and weight of vegetables, cooking times will vary.

→ Two-stage baking process - adjust temperature after the first stage.

Download from [Www.Somanuals.com](http://www.Somanuals.com). All Manuals Search And Download.











FAN BAKE			FAN FORCED		
Shelf	Temp °C	Time (mins)	Shelf	Temp °C	Time (mins)
6	160-175	8-12	5, 7	170-180	10-15
7	150-170	20-30	7	160-175	20-30
6	125-235	20-30	6	135-145	20-30
7	150-160	45-65	7	150-170	55-75
7	140-150	60-80	7	145-155	80-100
7	125-145	4-6 hrs	7	130-150	4-6 hrs
7	160-175	20-30	7	170-190	25-35
6	190-200	12-16	6	200-220	12-18
7	100-110	50-60	5, 7	110-120	55-65
6	190-210	8-12	6	190-210	10-12
7	180-210	15-25	7	190-210	15-30
7	200-230	12-18	7	225-250	15-20
8	175-190	25-30	7	180-200	25-30
7	160-175	25-30	7	175-190	30-35
7	200-220	10-20	7	210-225	10-20
7	175-200	30-40	7	185-210	35-45
7	170-190	20-30	7	180-200	20-30
7	170-190	30-40	7	180-200	35-45
7	175-195	12-16	7	180-200	14-18
7	170 → 110	7 → 20-25	7	180 → 120	7 → 20-25
7	175-195	12-16	7	180-200	14-18
7	165-175	10-15	7	170-180	15-20
7	150-160	35-45	7	160-170	35-45
7	170-180	50-60	7	175-190	60-70
7	155-170	45-50	7	175-180	45-50
7	150-165	45-60	7	170-180	45-60
7	170-180	20-30	7	175-190	25-30
-	-	-	4, 8	160	90-100
7	160-175	45-70	7	160-180	45-70
7	175-190	30-45	7	175-200	30-45

The above temperatures and times are a guide only and you may need to increase or decrease them depending on your preferences.

Roasting

Your Galaxy oven is equipped to handle a variety of roasts.

Tips for successful roasting

- When cooking large cuts of meat, times and temperatures are based on 30 minutes per 500 g/1 lb. Times and temperatures given below are guidelines and small adjustments may be necessary.
- Roasting times will be affected by the shape, size and temperature of the meat being roasted.
- Meat with a bone will cook more quickly than a boneless roast.
- Do not add water to your roast, as this steams the meat.
- For perfect results, use a meat probe or a meat thermometer.
- Let all roast meats and poultry stand for 10-15 minutes at the end of cooking before carving. This allows the meat fibres to relax. Fewer juices will be lost when it is cut and the meat will be juicier and more tender. To keep the meat warm, cover with foil.
- The meat will continue to cook during standing, so allow for this in your calculations (this is particularly important if you want a rare or medium rare roast).
- Roasting can be achieved with a range of cooking functions. FAN BAKE , FAN FORCED , BAKE  and FAN GRILL  can all be used for roasting, each giving unique results.
- Meats roasted on FAN GRILL  cook and brown in a rotisserie style. Radiant heat sears the outside surface while the inside remains tender and juicy. You do not need to preheat the oven on FAN GRILL .
- BAKE  is the traditional function for roasting. Cook one tray at a time.
- FAN FORCED  is perfect for roasting when you also need to cook other dishes on another shelf position.
- FAN BAKE  tends to brown and cook faster than BAKE .

Roasting chart

Food	Shelf	Temp °C	Mins/500 g	Internal temp °C
Meat				
Beef - rare	7	160-170	30-35	50-60
Beef - medium	7	160-170	35-45	65-70
Beef - well done	7	160-170	45-60	75-80
Mutton - well done	7	160-170	45-60	75-80
Hogget - medium	7	160-170	30-40	65-70
Hogget - well done	7	160-170	45-60	75-80
Pork - well done	7	180-185	40-45	75-80
Chicken - well done	7	160-180	25-30	82-85
Venison* - rare	7	220	3.5 per cm thickness	50-60

*Brown prior to roasting in an oiled frypan on high heat.

The above temperatures and times are a guide only and you may need to increase or decrease them depending on your preferences.

22 Galaxy cooktop/hob

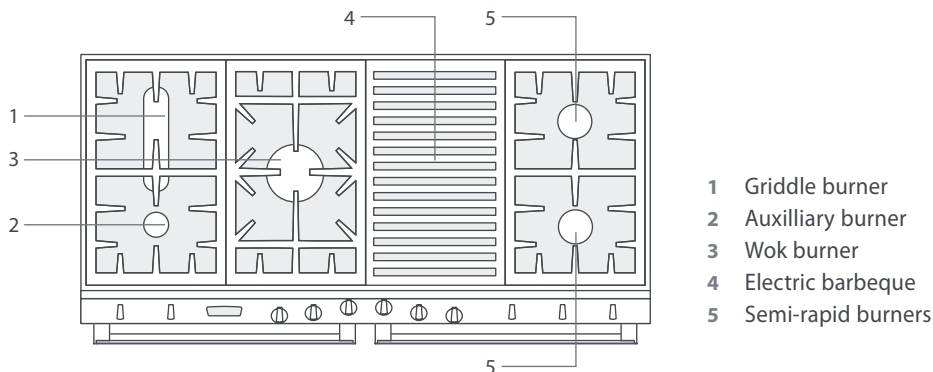



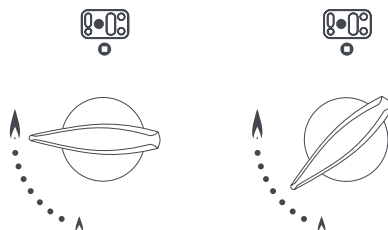

Fig. 10 Galaxy cooktop/hob

Before using the cooktop/hob

Before using your Galaxy cooktop clean it with warm soapy water and a soft cloth to remove dust. Check that the electricity is switched on in order for the electronic ignition to work.

Choose the cooktop control knob for the burner you want to use. Press down and turn the knob anti clockwise all the way to the  HI symbol. Hold down the knob for 5 seconds until the burner lights. All the igniters will spark until the gas ignites on the selected burner. The flame can be adjusted anywhere between the  HI symbol and the  LO symbol. Do not regulate the flame between high and the  OFF position.



If the cooktop/hob does not light

- Check that the power is switched on allowing the electronic ignition to work.
- Check that the burner rings are placed correctly.
- Clean electrode tips with a toothbrush and methylated spirits.
- The wok burner may need a moment to stabilise the inner ring of flame.
- Check that you know how the flame failure device works (see below).
- Check the gas supply is turned on.

If the burner has not ignited within 15 seconds, stop operating the igniter and wait at least 1 minute before attempting a further ignition of the burner. In the event of the burner flames being accidentally extinguished, turn off the burner control and do not attempt to re-ignite the burner for at least 1 minute.

Safety features

Your Galaxy cooktop has a flame failure safety device fitted. A metal probe behind the burner generates a small electrical current when a flame is present. After 5 seconds the metal probe gets hot enough to hold a valve open and maintain the gas supply. If the flame is blown out then the gas to the burner is cut off. To operate the flame failure you need to hold the burner knob down for 5 seconds after the burner has ignited. Letting go of the burner knob too soon will extinguish the flame.

Flame failure cooktop models have two probes at the back of the burners, one will be the spark electrode and the other is the flame failure probe.

Cooktop/hob utensils

To get the best out of your Galaxy cooktop follow these simple suggestions:

- Do not use an asbestos mat between the flame and the saucepan as this may cause serious damage to your cooktop.
- Never use plastic or aluminium foil dishes on the burners.
- Saucepans should have thick flat bottoms. Food in a saucepan with an uneven bottom will take longer to cook. Heavy saucepans may bend the trivets/pan support or deflect the flame. Match the bottom of your saucepans with the cooking zone and see that it is stable. This will give you the most efficient cooking. Do not let large saucepans or frying pans over lap the bench as this can deflect heat onto your benchtop and damage the surface.
- For the simmer (auxiliary) and semi rapid burners pots should be larger than 12cm in diameter. The griddle burner may be used with pots 18cm in diameter and above. The wok burner is primarily designed for woks but may be used with 17-23cm diameter pots with care. A fish kettle on the griddle burner is not only useful for fish, but for steaming long vegetables like cobs of corn, asparagus, Chinese broccoli and long beans.

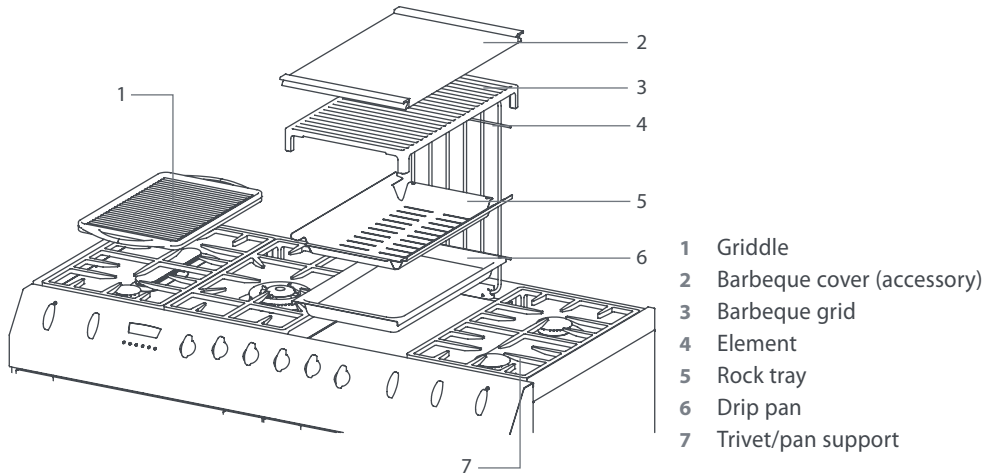

Fig. 11 Galaxy cooktop/hob

Using the barbeque

The Galaxy Barbeque provides the extreme heat needed to create the caramelised, juicy barbequed flavour achieved on an outdoor barbeque. The Galaxy Barbeque has a full range of heat settings from LO to HI. Turn the control knob clockwise to HI to begin cooking. Reduce the temperature when you are cooking by turning the control knob anti-clockwise. Preheat the grill for at least 10 minutes so that the barbeque grid and lava rocks can reach a suitable cooking temperature.

For initial browning of foods or searing of meat the temperature should be HI, and turned down to a lower temperature during the cooking period. Larger pieces of meat may need to be cooked at a lower temperature to allow the meat to cook through. During cooking, do not leave the Barbeque while it is on. Turn to \circ (Off) at the end of the cooking time.

Barbeque first use

Wash the barbeque grid in warm water. Use a scouring pad to remove any residue that might be on the grid. Rinse thoroughly and dry. Place the supplied lava rocks in the rock tray, position the rock tray on top of the drip pan and place under the element.

Cooking tips

- To minimise flame flare-ups trim the fat off the edges of steak, chops and poultry.
- Lean mince is best for hamburgers. Steaks are best cooked for a short time on a high heat to sear the outside and leave the inside tender. For a more well done steak, sear on HI, then turn down to cook through.
- When adding marinades and sauces, reduce the heat and add near the end of cooking.
- Use long handled utensils to turn your meats.

Using a griddle

Cooking with a griddle

A griddle is ideal for cooking a variety of foods. The surfaces of a cast-iron griddle will become more and more non-stick as cooking oils become baked in. This 'seasoning' process can be started by coating both surfaces of the griddle with cooking oil and baking in the oven at 150 °C (300 °F) for about an hour.

- Heat the griddle for a few minutes before using.
- Brush the food, not the griddle, with oil, to reduce splatter and smoking.
- Cook steak and vegetables at high temperatures on the ribbed side of the griddle. Turn the steak only once, about halfway through the cooking time. To test, press the surface of the steak. The softer the meat is, the 'rarer' or less well done it will be.
- Griddle scones, pancakes, pikelets, polenta and eggs are best cooked slowly at medium to low temperatures on the flat side of the griddle.

Important!

Prolonged cooking with the griddle at high temperatures may damage the cooktop.

Cleaning a cast-iron griddle

- Leave the griddle to cool before cleaning. Scrape away any food residue and wash in warm soapy water.
- Do not scour to the bare metal when cleaning the griddle or you will remove the non-stick coating that has built up during cooking.
- Dry the griddle thoroughly and wipe with a thin coating of cooking oil to prevent rust forming, especially when the griddle is new.

Cleaning the outside of the Galaxy

Important!

Do not use abrasive cleaners or a steam cleaner on the outside surfaces of the Galaxy oven.

Before cleaning the outside of your Galaxy oven, we recommend you turn it off at the wall. Wipe the outside surfaces often, using warm water and a household detergent and/or a stainless steel cleaner and polish.

Cleaning the inside of the oven

Important!

Before you start cleaning inside your oven/s, please:

- *Read these cleaning instructions and the 'Safety and warnings' section at the start of this guide.*
- *Turn the Galaxy oven off at the wall.*
- *Make sure the Galaxy oven is a safe temperature to touch.*

Do not use a steam cleaner to clean the inside of the oven/s.

Do not use any oven cleaners, abrasive cleaners, ammonia-based cleaners or detergents on the self-cleaning oven liners. See 'Caring for the self-cleaning liners'.

It is easier to clean the oven while it is still warm, using household detergents or an ammonia-based cleaner. You may use 'off the shelf' oven cleaners, if you carefully follow the manufacturers' instructions.

To make cleaning easier, you can remove the wire shelf supports, the oven door, and the fan cover. The top element also drops down to make cleaning the oven roof easier.

Removing and replacing the oven door

- 1 To remove the oven door, open the door fully, lift the clips (C) back towards you onto the hooks (A).
- 2 Raise the door slightly, holding it on either side near the handle, Make sure the clips stay on the hooks (A) and lift the door out.
- 3 To put the door back on, place the upper hinge arm (B) in the upper slot and the lower hinge arm (D) in the lower slot. Push the hinge arms in as far as they will go until the slot in the lower arm locates in the hinge support.
- 4 Lower the door gently and release the clips.
- 5 Raise the door slightly to make sure the clips are released from the hooks. Close the door.

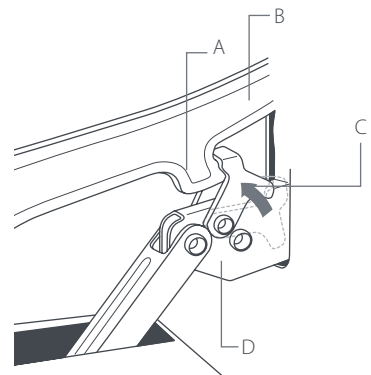

- A. Hook
- B. Upper hinge arm
- C. Clip
- D. Lower hinge arm

Fig.12 Removing the oven door

Removing and replacing the oven lamp

Always turn the Galaxy off at the wall before touching an oven lamp. To clean the oven more easily, pull off the glass cover. If you need to replace the light bulb, simply unscrew it.

Removing and replacing the shelf supports

- 1 Push the shelf slides in position 7 back into the oven.
- 2 To remove the shelf supports gently push the retaining wire from underneath the stud then swing the lowest edge of the shelf support up and out towards the centre of the oven. The prongs at the top will slide out.
- 3 To replace the shelf support, hold them horizontally and locate the prongs into the small slots at the top of oven cavity.
- 4 Lower the shelf support and gently place the retaining wire underneath the stud.

Important!

To avoid chipping the enamel – do not lower the shelf supports until the prongs are fully inserted into the small slots at the top of the oven.

Cleaning the shelf slides

Important!

Do not wash the shelf slides in the dishwasher. Do not immerse them in soapy water, or use oven cleaner on them. Removing the 'white' lubricating grease will reduce the life of the shelf slides and prevent them from running smoothly.

Wipe the shelf slides with a damp cloth and a mild detergent only. Do not wipe off or wash away the 'white' lubricating grease (you can see this when the slides are extended).

Caring for the self-cleaning liners

Self-cleaning liners are supplied with some models of the Galaxy oven. They help reduce manual oven cleaning. The liners are coated with a special enamel which is porous and contains oxidising catalysts.

Any grease and dirt coming into contact with the liner is absorbed by the enamel and is broken down with the help of the oxidising catalysts at normal cooking temperatures.

As cleaning is improved by using a high temperature, it may be necessary to occasionally run the empty oven on FAN GRILL  at 200 °C for 1 to 1½ hours.

Cleaning the cooktop/hob

Use warm soapy water for cleaning when the cooktop is cold. Apply soapy water with a soft sponge or cloth. Do not use steel soap pads as these may dull the appearance of your appliance over time. Trivets/pan supports can be washed in the dishwasher. Abrasive cleaners may damage the stainless steel, trivets/pan supports and the knobs. After cleaning, wipe dry with a clean cloth to ensure the surface is thoroughly dry. For extra shine, use a stainless steel polish. Do not use abrasive cleaners on any part of the cooktop as these may damage the cooktop.

The burner and burner caps can be cleaned in hot water, it is important that the holes are kept clear. When replacing the burner rings after cleaning, turn the rings until the positioning teeth are placed correctly. Be careful of sharp edges at each end of the cooktop/hob.

Cleaning the barbeque

Place the barbeque grid in hot water with a small amount of detergent when cool to touch. If there is food residue left on the Grid, scrub with a wire barbeque brush to remove it. Make sure that the Barbeque Grid is completely dry before replacing.

The rock tray, lava rocks and drip pan can also be removed and washed to get rid of any build up of fat and food. Lift up the element when cool to touch, to remove the rock tray & drip pan. Fat that accumulates in the tray lip can be removed by wiping with a paper towel. Clean the lava rocks by boiling for 20 minutes in a large container of water and dishwashing detergent. Sun dry and replace. The rocks will change colour after use.

Before you call for service or assistance ...

Check the things you can do yourself. Refer to the installation instructions and your user guide and check that:

- 1 Your product is correctly installed.
- 2 You are familiar with its normal operation.

If after checking these points you still need assistance, please refer to the Service & Warranty book for warranty details and your nearest Authorised Service Centre, or contact us through our website:

www.fisherpaykel.com

Gas rate summary - NZ AU

Your Product is factory set for Natural Gas. Refer to the appropriate chart for ratings.

BURNERS	NATURAL GAS		LP GAS	
	Injector orifice	MJ/h @1kPa	Injector orifice	MJ/h @2.75kPa
Semi-Rapid (RH Front & RH Rear)	1.3 mm	8.1 MJ/h	0.80 mm	8.0 MJ/h
Auxiliary Burner (LH Front)	0.85 mm	3.5 MJ/h	0.55 mm	3.9 MJ/h
Griddle Burner (LH Rear)	1.35 mm	8.8 MJ/h	0.80 mm	8.0 MJ/h
Wok Burner (Centre)	1.65 mm	13 MJ/h	0.92 mm	11.3 MJ/h

Your Product is factory set for Natural Gas. Refer to the appropriate chart for ratings.

DI1203DG	Griddle Burner (LH rear)					Wok Burner (centre)				
	NG		LP Gas			NG		LP Gas		
Cat	Injector Orifice	Nominal Rating (kW)	Injector Orifice	Nominal Rating (kW)	Gas Rate (g/h)	Injector Orifice	Nominal Rating (kW)	Injector Orifice	Nominal Rating (kW)	Gas Rate (g/h)
II 2H3 + II 2H3 B/P (30) II 2E3 +	118	2.60	080	2.50	182	140	3.60	095	3.60	263
II 2L3 B/P (30)	118	2.40	080	2.50	182	145	3.50	095	3.60	263
II 2E3 B/P (50)	118	2.60	070	2.60	190	140	3.60	076	3.60	263

DI1203DG	Auxiliary					Semi-Rapid (RH front, RH rear)				
	NG		LP Gas			NG		LP Gas		
Cat	Injector Orifice	Nominal Rating (kW)	Injector Orifice	Nominal Rating (kW)	Gas Rate (g/h)	Injector Orifice	Nominal Rating (kW)	Injector Orifice	Nominal Rating (kW)	Gas Rate (g/h)
II 2H3 + II 2H3 B/P (30) II 2E3 +	75	1.0	050	1.0	73	100 Z	2.0	073	2.15	157
II 2L3 B/P (30)	75 S	1.0	050	1.0	73	105 Z	2.0	073	2.15	157
II 2E3 B/P (50)	75	1.0	043	1.0	73	100 Z	2.0	062	2.10	153

Copyright © Fisher & Paykel 2006. All rights reserved.

The product specifications in this booklet apply to the specific products and models described at the date of issue. Under our policy of continuous product improvement, these specifications may change at any time. You should therefore check with your Dealer to ensure this booklet correctly describes the product currently available.

www.fisherpaykel.com

NZ AU GB IE

Galaxy user guide

Published: 03/2006

Part No. 542817 A

Free Manuals Download Website

<http://myh66.com>

<http://usermanuals.us>

<http://www.somanuals.com>

<http://www.4manuals.cc>

<http://www.manual-lib.com>

<http://www.404manual.com>

<http://www.luxmanual.com>

<http://aubethermostatmanual.com>

Golf course search by state

<http://golfingnear.com>

Email search by domain

<http://emailbydomain.com>

Auto manuals search

<http://auto.somanuals.com>

TV manuals search

<http://tv.somanuals.com>