

MX3

MINI BIKE



Product features may vary from this picture.
Protective equipment not included.

Please read this manual and save it with your original sales receipt.
Tools needed for assembly (not included): Two Adjustable Wrenches (or one Adjustable Wrench and a $\frac{7}{16}$ " Wrench and $\frac{9}{16}$ " Wrench), Pliers, Phillips Screwdriver, and Safety Scissors.

Tool needed for assembly (included): Allen Wrench.

Use only with a Power Wheels® 12 Volt Lead-Acid Rechargeable Battery and a Power Wheels® 12 Volt Charger with Type "12V" Connector (both included).

Fisher-Price, Power Wheels, and Power Wheels by Fisher-Price are U.S. trademarks of Mattel, Inc.



Owner's Manual with Assembly Instructions

For Model 73535

Table of Contents

A	Important Information	.2
B	Warnings and Cautions	.3
C	Parts	.4
D	Battery Charging	.5
E	Assembly	.7
F	Adjusting the Brake	.11
G	Label Decoration	.13
H	Battery Installation	.14
I	Battery Care and Disposal	.15
J	Rules for Safe Riding	.16
K	How to Operate Your Mini-Bike	.17
L	Caring for Your Mini-Bike	.18
M	Problems and Solutions Guide	.19
N	Limited Warranty	.22
O	Authorized Service Centers	.23

A

Important Information

- Your new mini-bike requires adult assembly. Please set aside at least 30 minutes for assembly.
- You must charge your battery for 18 - 30 hours **before you use your mini-bike for the first time.** We recommend that you start charging your battery before beginning assembly. Please see Battery Charging beginning on page 5 for detailed instructions.
- Read this manual carefully for important safety information and operating instructions before using your mini-bike. Keep these instructions for future reference as they contain important information.
- This product is meant for outdoor use only, on private property. It should not be used on streets, alleys or other public thoroughfares.
- Use the mini-bike **ONLY** outdoors. Most interior flooring can be damaged by riding this mini-bike indoors. Fisher-Price® will not be responsible for damage to floors if the mini-bike is used indoors.
- Your child must have experience and skill at riding a two wheel bicycle without training wheels before using this mini-bike.
- This mini-bike is designed for use on dirt, grass or other hard surfaces; on generally level terrain; by children 6 years of age and older who can ride a two-wheeler without training wheels or any other assistance.
- Your child should not wear open-toe shoes.
- Keep loose laces and pant legs away from the wheels.
- Choose areas for riding that are free of obstacles, and avoid wet, loose dirt or uneven surfaces.
- To prevent damaging the motor, belt and pulleys, do not tow anything behind the mini-bike or overload it. Do not exceed the maximum weight capacity of 150 lb. (68 kg).
- To prevent damage, do not use the mini-bike on wet surfaces or in wet weather. Never immerse any part of this product. Moisture can damage switches and drive components.
- Do not ride in mud. Mud can clog the drive train system and possibly lead to the belt slipping off.
- If you have any questions about your Power Wheels® mini-bike, please call our toll-free service lines at **1-800-348-0751** from 8 AM to 6 PM (EST) Monday through Friday. Trained customer service representatives are available to take your call in English or French. Habla Español? Si usted tiene alguna pregunta ó necesita asistencia llame gratis **1-800-348-0755** para los Estados Unidos. Tenemos representantes que hablan español para atender su llamada.
- For your convenience, Power Wheels® maintains an **independently owned and operated** Authorized Service Center Network with more than 400 authorized service centers nationwide. The authorized service centers will repair or replace parts under warranty at no extra charge, and can perform non-warranty repairs for a minimal charge. Please see the Authorized Service Center list beginning on page 24 to find the authorized service center nearest you, or call **1-800-348-0751**.
- Please complete and return the enclosed Registration Card today, or call **1-800-348-0751** to register your mini-bike by phone, or register on-line at www.powerwheels.com.

ELECTRICAL HAZARD **WARNING**

- Battery can fall out and injure a child if vehicle tips over. Always use battery clamp (cover).
- **PREVENT FIRE**
 - Never modify the electrical system. Alterations could cause a fire resulting in serious injury and could also ruin the electrical system.
 - Use of the wrong type battery or charger could cause a fire or explosion resulting in serious injury.
 - Use of Power Wheels® components in products other than Power Wheels® vehicles could cause overheating, fire or explosion.
- The battery must be handled by adults only. The battery is heavy and contains sulfuric acid (electrolyte). Dropping the battery could result in serious injury.
- Never allow children to charge the battery. Battery charging must be done by adults only. A child could be injured by the electricity involved in charging the battery.
- Read the safety instructions on the battery.
- Examine the battery, charger and their connectors for excessive wear or damage each time you charge the battery. If damage or excessive wear is detected, do not use the charger or the battery until you have replaced the worn or damaged part.
- **HOT** motor. Handle carefully.

RIDING RULES **WARNING****Direct Adult Supervision Required**

- To prevent injury, keep away from cars, streets, steep inclines, steps, swimming pools and other bodies of water.
- Protective equipment should be worn. Use helmet, knee pads and elbow pads (not included).
- Always wear shoes.
- Never allow more than one (1) rider.
- Never ride at night.

 **CAUTION**

- In the unassembled state, this package contains small parts. Adult assembly is required.
- Use the charger in dry locations only.

C

Parts

- If you experience a problem with this product, or are missing a part, please call us at **1-800-348-0751**, rather than return this product to the store.
- Please identify all parts before assembly and save all packaging material until assembly is complete to ensure that no parts are discarded.
- Metal parts have been coated with a lubricant to protect them during shipment. Wipe all metal parts with a paper towel to remove any excess lubricant.

Part Not Shown: Label Sheet.



12 Volt Battery



12 Volt Charger



Allen Wrench

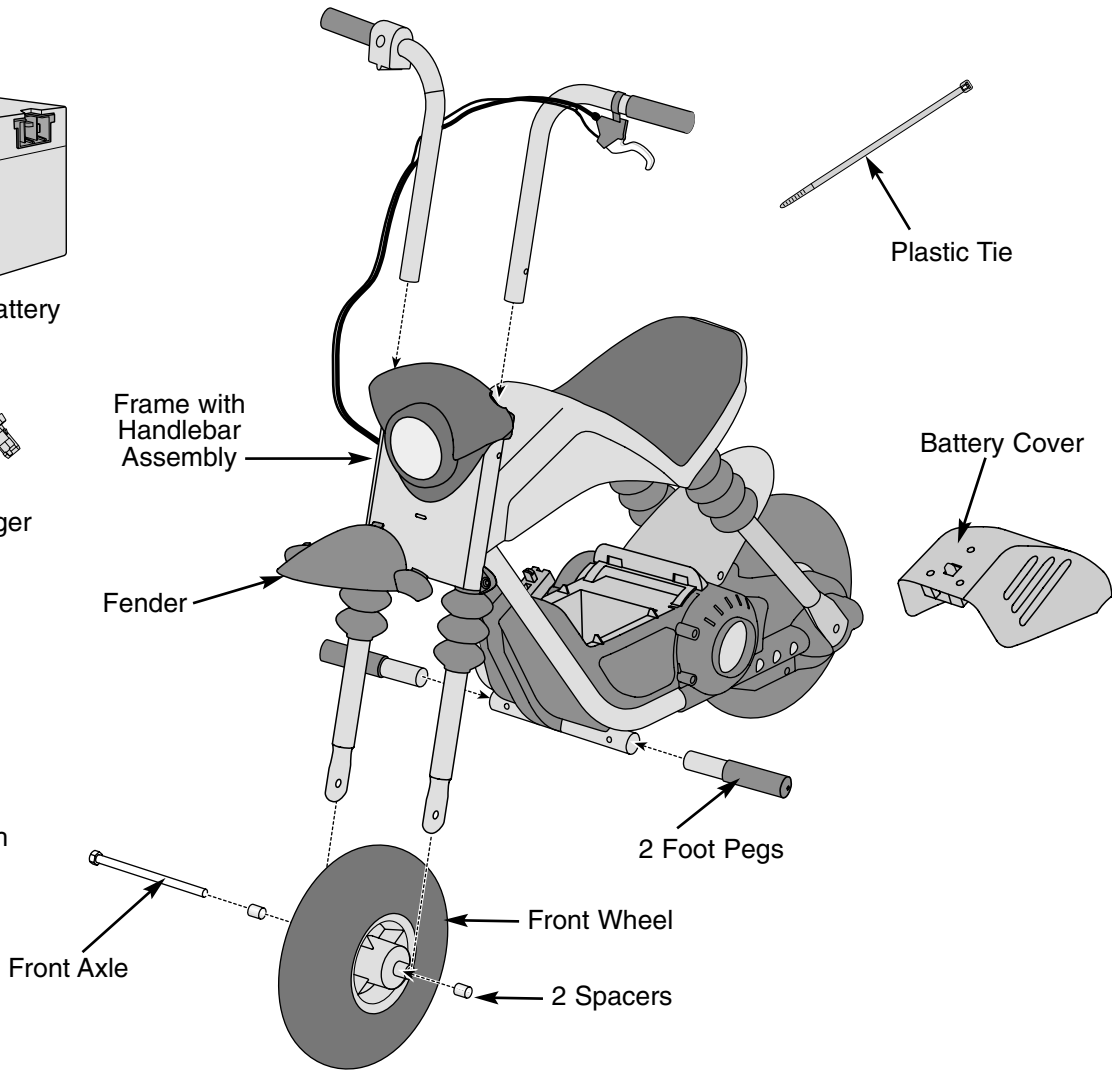

1⁹/₁₆" Bolt - 4



#8 x 1" Screw - 2

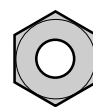

7/16" Lock Nut - 4

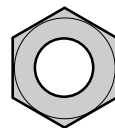

9/16" Lock Nut - 1

FASTENERS SHOWN ACTUAL SIZE

ELECTRICAL HAZARD **WARNING**

- Battery can fall out and injure a child if mini-bike tips over. Always use battery clamp (cover).
- **PREVENT FIRE**
 - Never modify the electrical system. Alterations could cause a fire resulting in serious injury and could also ruin the electrical system.
 - Use of the wrong type battery or charger could cause a fire or explosion resulting in serious injury.
 - Use of Power Wheels® components in products other than Power Wheels® vehicles could cause overheating, fire or explosion.
- The battery must be handled by adults only. The battery is heavy and contains sulfuric acid (electrolyte). Dropping the battery could result in serious injury.
- Never allow children to charge the battery. Battery charging must be done by adults only. A child could be injured by the electricity involved in charging the battery.
- Read the safety instructions on the battery.
- Examine the battery, charger and their connectors for excessive wear or damage each time you charge the battery. If damage or excessive wear is detected, do not use the charger or the battery until you have replaced the worn or damaged part.

 **CAUTION**

Use the charger in dry locations only.

About Thermal Fuses

Your Power Wheels® 12 volt battery is equipped with a built-in thermal fuse. The thermal fuse is a self-resetting safety device which automatically “trips” and shuts down operation of the mini-bike if the mini-bike is overloaded or the driving conditions too severe. Once a fuse has “tripped”, it will automatically reset itself after approximately 25 seconds and allow the mini-bike to resume normal operation. To avoid repeated automatic shutdowns, do not overload the mini-bike by exceeding the 150 lb. maximum weight capacity or by towing anything behind the mini-bike. Avoid severe driving conditions, such as driving up steep slopes or running into fixed objects, which can cause the wheels to stop spinning while power is still being supplied to the motors.

If a thermal fuse in a battery continually trips under normal driving conditions, please contact your local Power Wheels® Authorized Service Center. For the location of the Authorized Service Center nearest to you, see page 23 or call **1-800-348-0751**.

Battery Charging

IMPORTANT!

- **Your new battery must be charged for at least 18 hours before you use it in your mini-bike for the first time.** We recommend that you start charging your battery before beginning assembly of your new mini-bike.
- The battery must be upright while charging.
- The charger is not a toy.
- Do not short circuit the battery.
- Before charging the battery, examine the battery case for cracks and other damage which may cause sulfuric acid (electrolyte) to leak during the charging process. If damage is detected, do not charge the battery or use it in your mini-bike. Battery acid is very corrosive and can cause severe damage to surfaces it contacts.
- Do not charge the battery on a surface (such as kitchen countertops) which could be damaged by the acid contained inside the battery. Take precautions to protect the surface on which you charge your battery.
- Use only a Power Wheels® 12 volt charger with type "12V" connector (120 VAC 60 Hz 28W with an output of 12 VDC 1200mA) to charge your Power Wheels® rechargeable 12 volt battery.
- For best performance, use only a Power Wheels® 12 volt battery. Please contact your local Power Wheels® Authorized Service Center for a replacement battery. To find the authorized service center nearest you, see page 23 or call **1-800-348-0751**.
- If your battery is old and will not accept a charge, do not leave it in the mini-bike. Always remove a dead battery from the mini-bike.

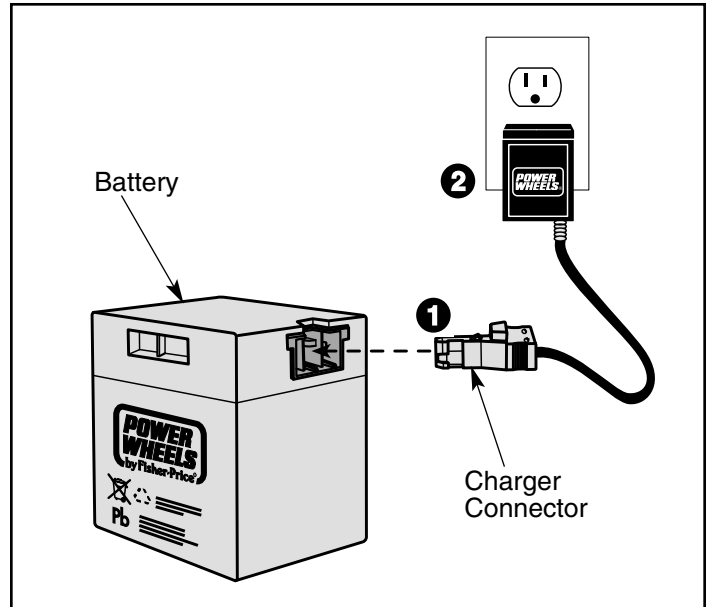

- Plug the charger connector into the battery **1**.
- Plug the charger into a standard 120 volt wall outlet **2**.

Note: If power flow to the wall outlet is controlled by a switch, make sure the switch is "ON".

- Before first-time use, charge the battery for **at least 18 hours**. Never charge the battery longer than 30 hours.
- Recharge the battery for at least 14 hours after each use of your vehicle. Do not charge the battery longer than 30 hours.
- Once the battery is charged, pull firmly on the charger connector to disconnect it from the battery. Unplug the charger from the wall outlet. The battery is now ready to be installed in your mini-bike. Please see the Battery Installation section on page 14 for detailed instructions to install your battery.

WARNING

Children can be harmed by small parts, sharp edges and sharp points in the mini-bike's unassembled state, or by electrical items. Care should be taken in unpacking and assembly of the mini-bike. Children should not handle parts, including the battery, or help in assembly of the mini-bike.

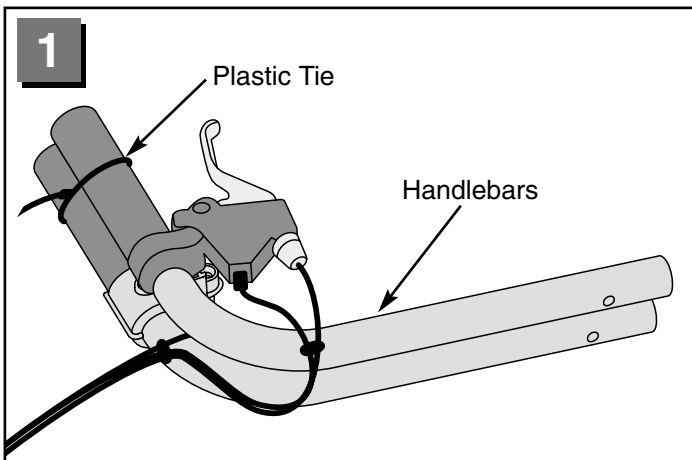

- Using safety scissors, remove the plastic tie from the handlebars. **DO NOT** cut the power wires or brake cables.

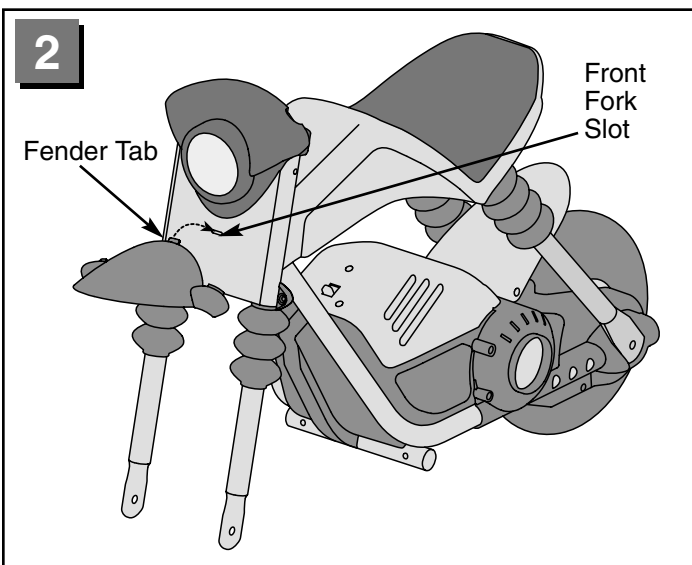

- Stand the frame assembly upright.
- At an angle, insert the fender tab into the slot in the front fork. Lower the fender into place.

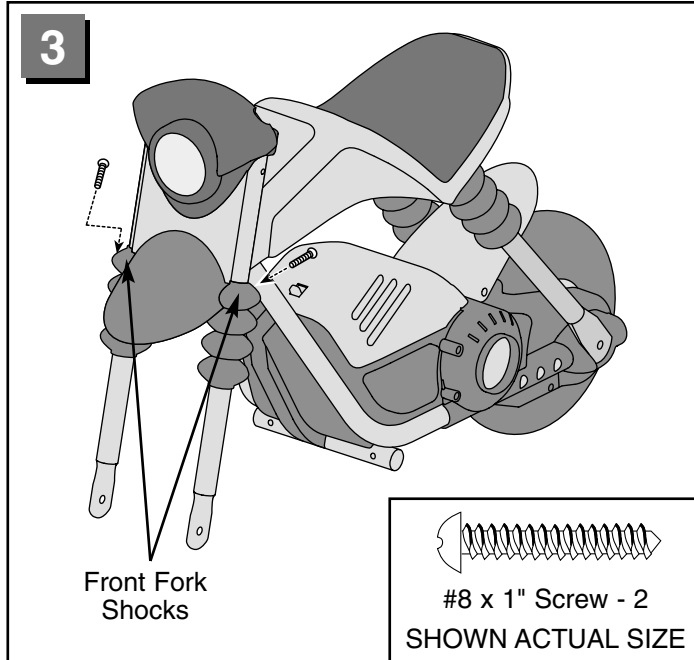

- Insert a #8 x 1" screw through the hole in each front fork shock and into the fender. Tighten the screws with a Phillips screwdriver. Do not over-tighten.

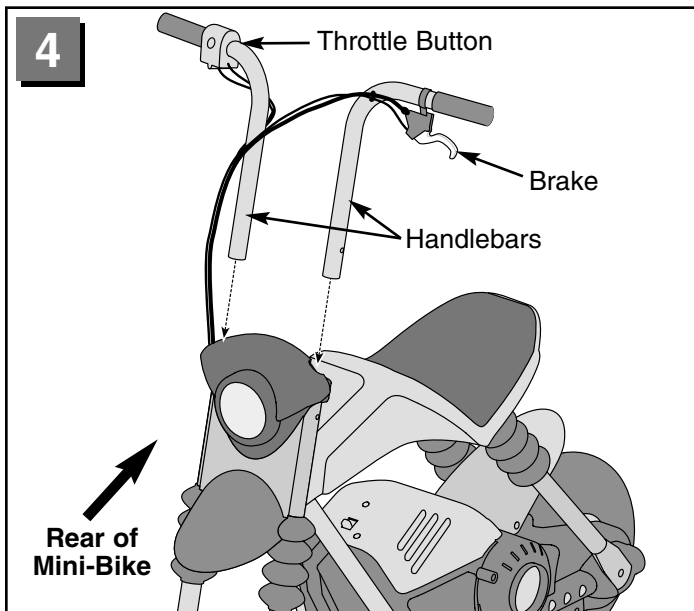

- Position the handlebars so that the grips point outward and the throttle button faces the rear of the mini-bike.
- Hint:** If you are sitting on the seat of the mini-bike, the power button will be on the right and the brake will be on the left.
- Insert each handlebar into the holes in the front fork.

Assembly

5

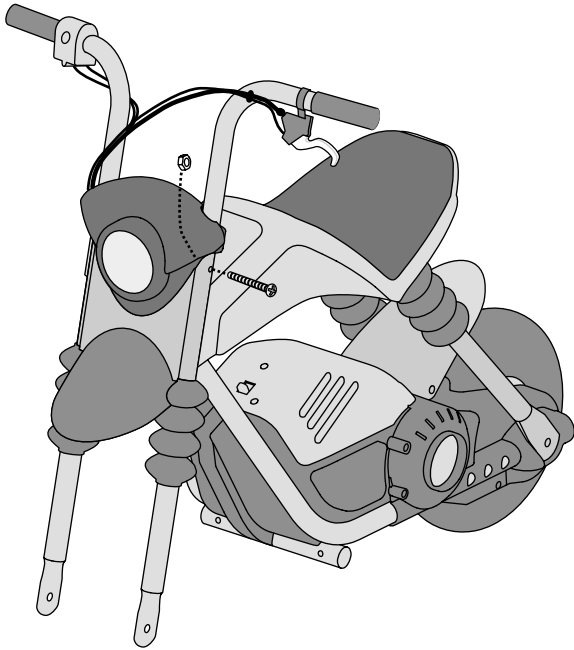

1 9/16" Bolt - 2

Rounded Edge

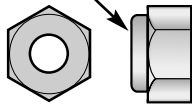

7/16" Lock Nut - 2

BOTH SHOWN ACTUAL SIZE

- Lift a handlebar to align the hole in the handlebar with the hole in the front fork.
- Insert a 1 9/16" screw through the outer edge of the front fork, handlebar and then out the inner edge of the front fork.
- Attach a 7/16" lock nut (rounded edge outward) to the end of the screw and hand-tighten it.

6

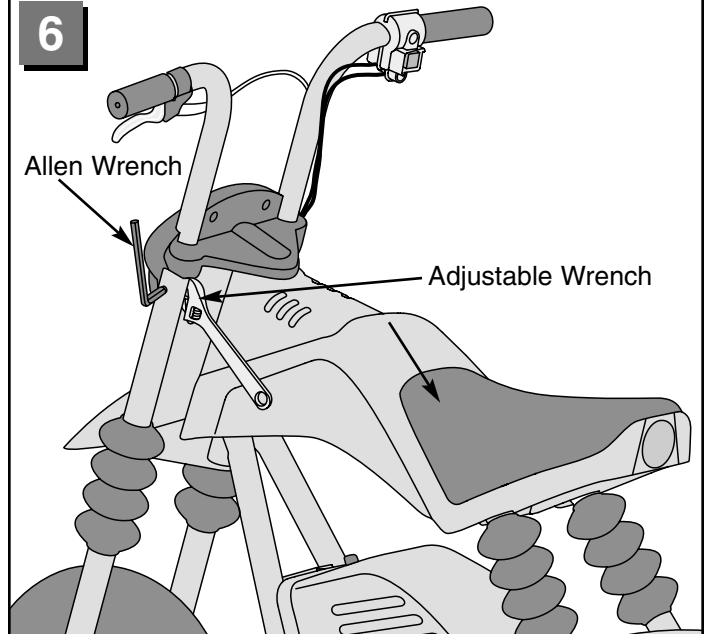

- While holding the lock nut with an adjustable wrench (or a 7/16" wrench), tighten the bolt with the Allen wrench. Do not over-tighten.
- Check to be sure the handlebar is securely attached. Lift it and push it from side to side. It should not move. If it does move, tighten the bolt a few more turns with the Allen wrench.
- Repeat steps 5 and 6 to fasten the other handlebar to the front fork with a 1 9/16" bolt and 7/16" lock nut.

7

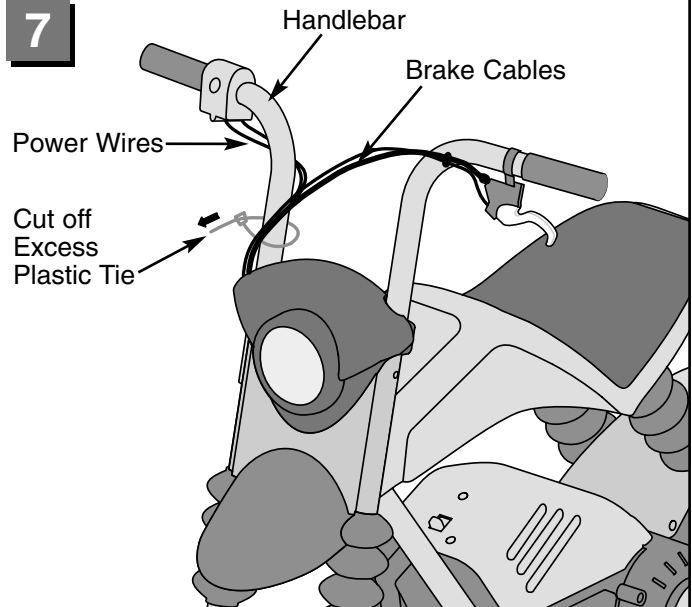

- Wrap the plastic tie around the brake cables, power wires and the handlebar.
- Insert the flat end of the plastic tie into the opening in the square end of the plastic tie. Pull the flat end of the plastic tie with pliers to be sure it is tight around the handlebar.
- Using safety scissors, cut off the excess plastic tie. Throw the excess plastic tie away.

8

Assembly

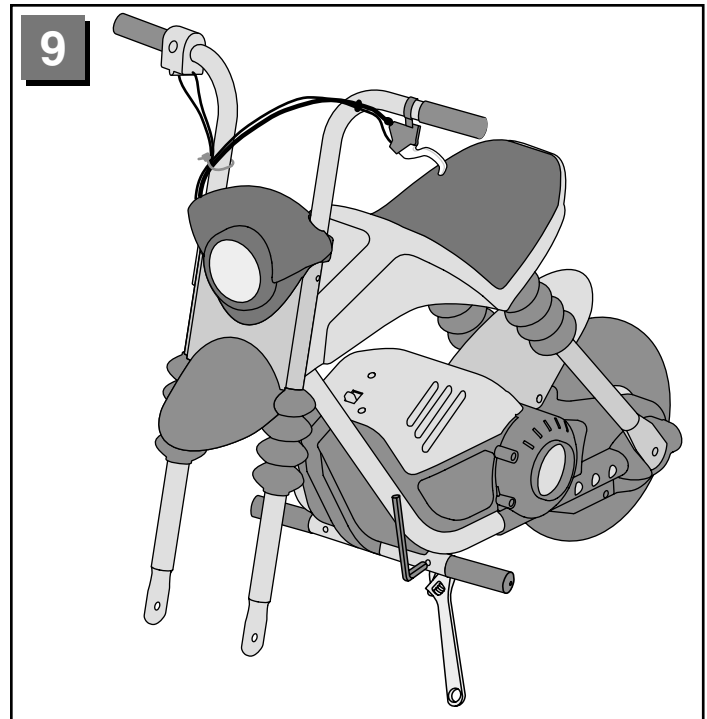
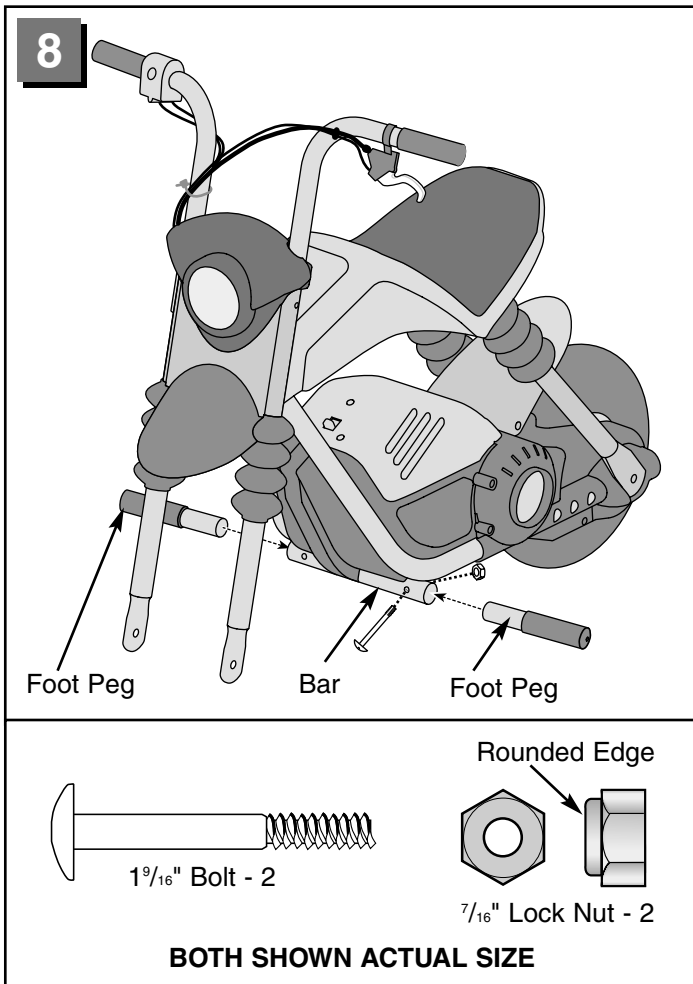

- While holding the lock nut with an adjustable wrench (or a $\frac{7}{16}$ " wrench), tighten the bolt with the Allen wrench. Do not over-tighten.
- Check to be sure the foot peg is securely attached. Push and pull it. It should not move. If it does move, tighten the bolt a few more turns with the Allen wrench.
- Repeat steps 8 and 9 to fasten the other foot peg to the bar with a $1\frac{9}{16}$ " bolt and $\frac{7}{16}$ " lock nut.

- Fit a foot peg to the end of the bar on the bottom of the mini-bike.
- Turn the foot peg to align the hole in the foot peg with the hole in the bar.
- Insert a $1\frac{9}{16}$ " bolt through the front hole in the bar, the foot peg and out the back hole in the bar.
- Attach a $\frac{7}{16}$ " lock nut (rounded edge outward) to the end of the bolt and hand-tighten it.

Assembly

10

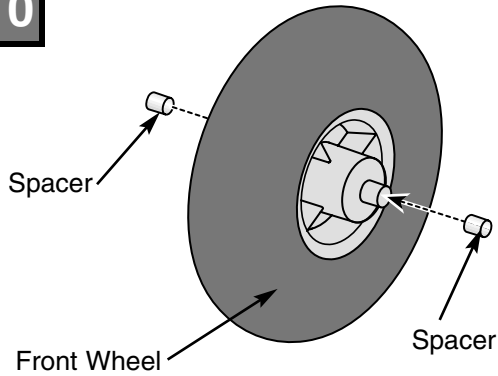

- Fit a spacer into the hole on each side of the front wheel.

11

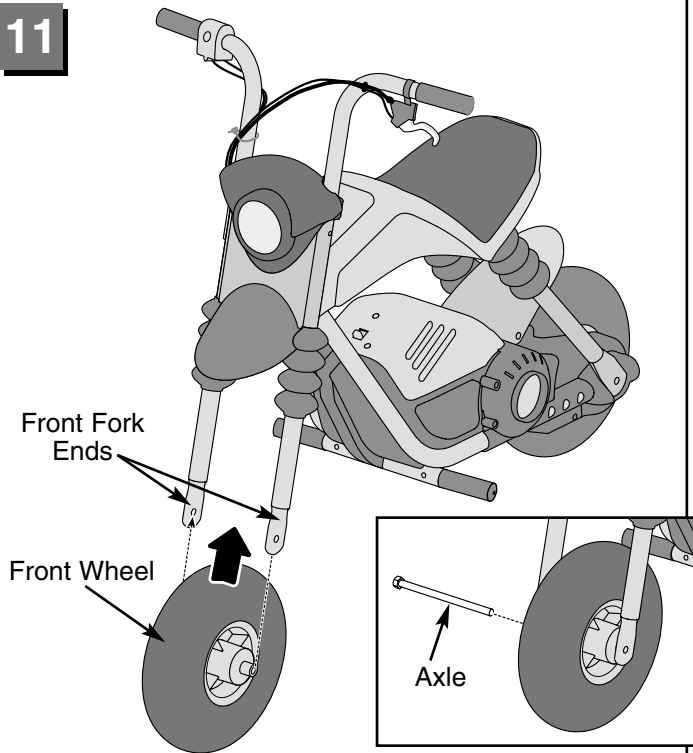

- Fit the front wheel (with spacers inserted) between the ends of the front fork.
- Insert the axle through one side of the front fork, the front wheel and out through the other side of the front fork.

12

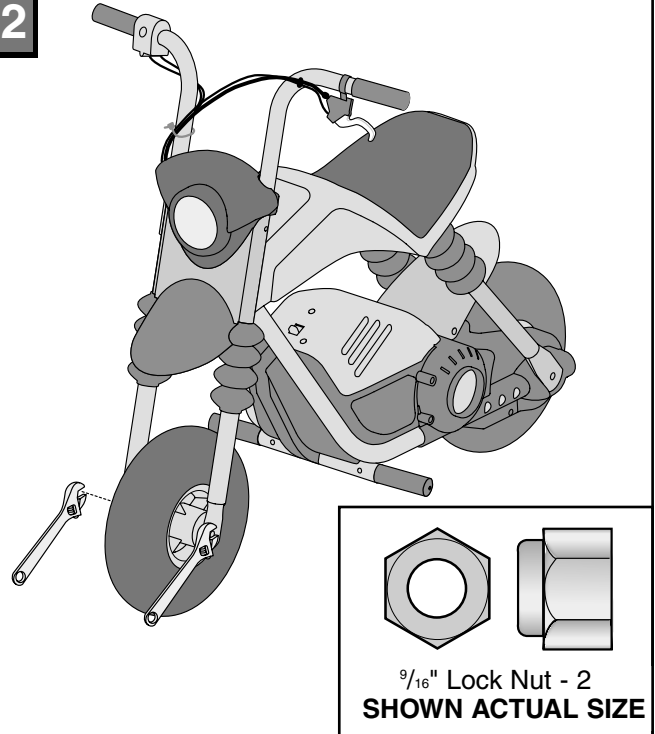

- Attach the $\frac{9}{16}$ " lock nut to the end of the axle. While holding the lock nut with an adjustable wrench, tighten the axle with a $\frac{9}{16}$ " wrench (or another adjustable wrench). Do not over-tighten.

13

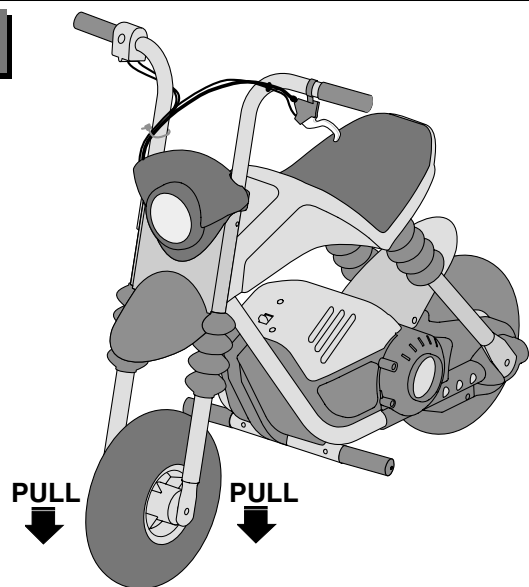

- Check to be sure the wheel is secure on the front fork. Pull the wheel down. It should not move. If it does move, tighten the axle a few more turns with the $\frac{9}{16}$ " wrench (or another adjustable wrench).

IMPORTANT! Assembly is now complete, but you **must adjust the hand brake before first time use**. Please proceed to the section *Adjusting the Brake*, page 11.

F

Adjusting the Brake

IMPORTANT! Check to be sure the brake is adjusted properly and is tight. Please follow these instructions carefully before you use this mini-bike.

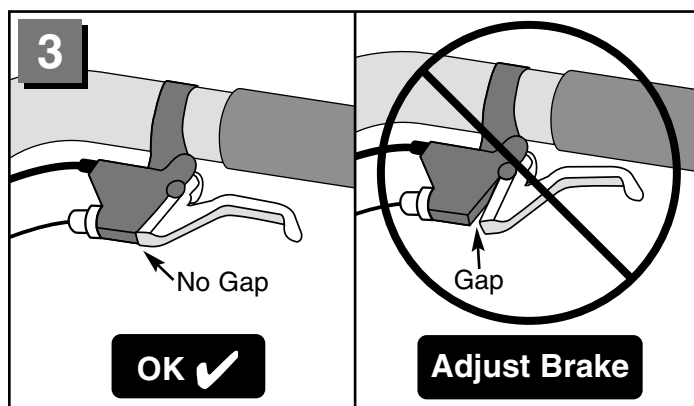
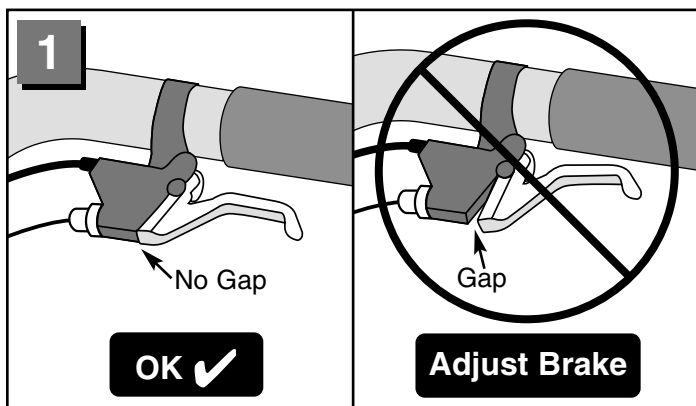

- From the front of the handlebar, examine the brake handle and the brake base.
 - **If there is NO gap** between the brake base and the brake handle, your brake is properly adjusted. Please proceed to the label decoration section on page 13.
 - **If there IS a gap** between the brake base and the brake handle, your brake **needs to be adjusted** and tightened. Please go on to step 2 in this section.

- Now, from the front of the handlebar, examine the brake handle again.
 - **If there is NO gap** between the brake base and the brake handle your brake is properly adjusted. Please proceed to the label decoration section on page 13.
 - If you cannot eliminate the gap or if the brake adjustment knob unthreads from the brake base, proceed to step 4.

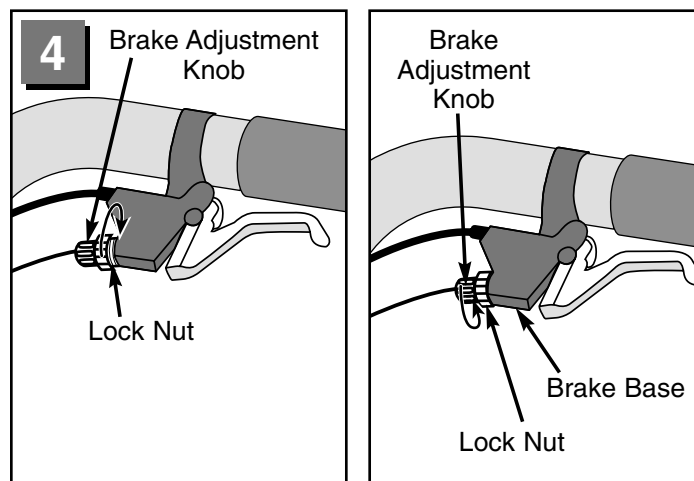
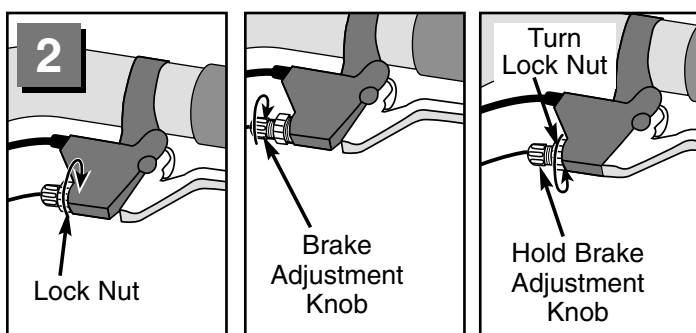

- Turn the lock nut clockwise a few times to loosen it.
- Turn the brake adjustment knob clockwise a few times to tighten the brake and close the gap between the brake base and brake handle.
- When the gap is closed, hold the brake adjustment knob in position and turn the lock nut counter-clockwise tight against the brake base to secure the adjustment.

- Turn the lock nut clockwise until it stops against the brake adjustment knob.
- Turn the brake adjustment knob counter-clockwise until the lock nut stops against the brake base.

Adjusting the Brakes

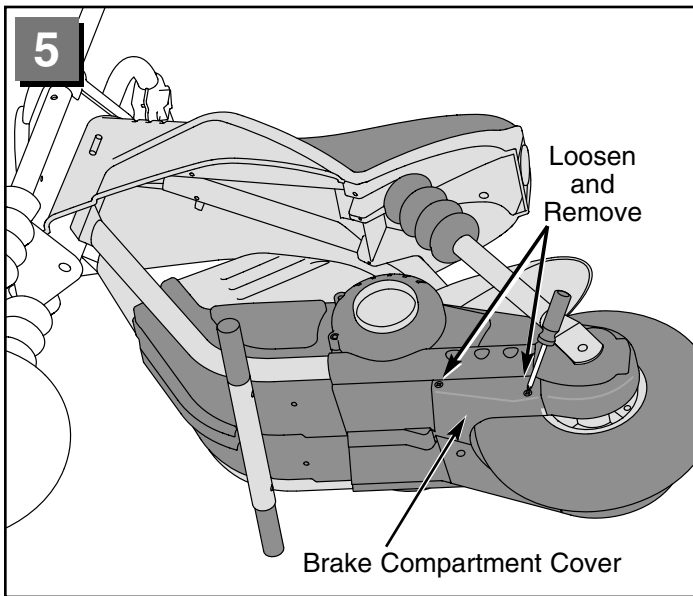

- Turn the mini-bike on its side.
- Loosen and remove the screws in the brake compartment cover.

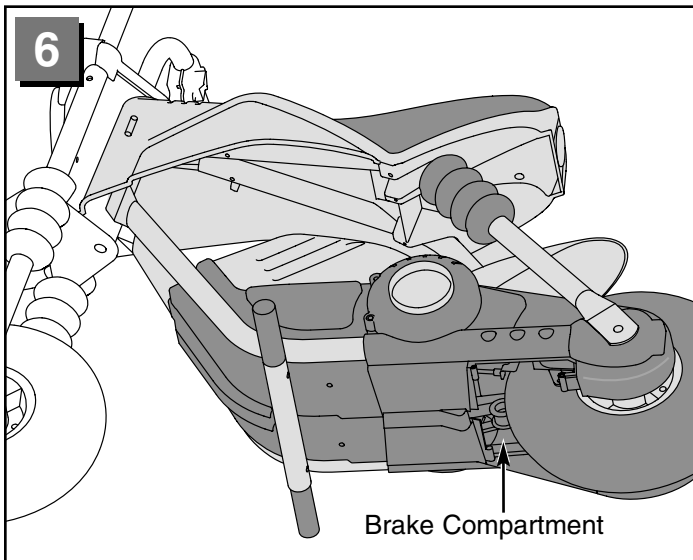

- Turn the mini-bike over and remove the other two screws in the brake compartment cover.
- Remove the brake compartment cover and locate brake cable, lock nut and adjustable knob.

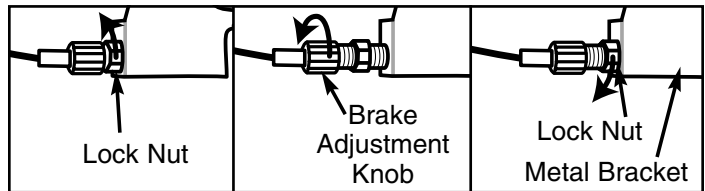

- Turn the lock nut counter-clockwise a few turns to loosen it.
- Turn the brake adjustment knob counter-clockwise a few turns to close the gap.
- Again, examine the brake handle to be sure there is no gap between the brake base and the brake handle. Re-tighten the brake adjustment knob if still needed.
- After you are satisfied that you have properly closed the gap between the brake base and the brake handle, hold the brake adjustment knob in position and turn the lock nut clockwise until it stops against the metal bracket.
- Replace the brake compartment cover and the four screws. Tighten all four screws with a Phillips screwdriver. Do not over-tighten.

Hint: The location of the brake handle is adjustable for your child's comfort. To adjust, loosen the screw on the back of the brake handle with the Allen wrench provided. Slide or rotate the handle to the desired location and re-tighten the screw with the Allen wrench.

G

Label Decoration

Proper label application will help to keep the labels looking their best! When applying labels, keep the following guidelines in mind:

- Wash your hands before applying the labels.
- Before applying the labels, wipe the surface of the mini-bike with a clean, dry cloth to remove any dust or oils.
- Place the labels exactly as shown in the illustrations.
- For best results, avoid repositioning a label once it has been applied to the mini-bike.
- After applying a label, rub the label firmly with a clean, dry cloth to make sure the label is adhered to your mini-bike. Start at the center of a label, and smooth towards the outer edges to remove air bubbles.

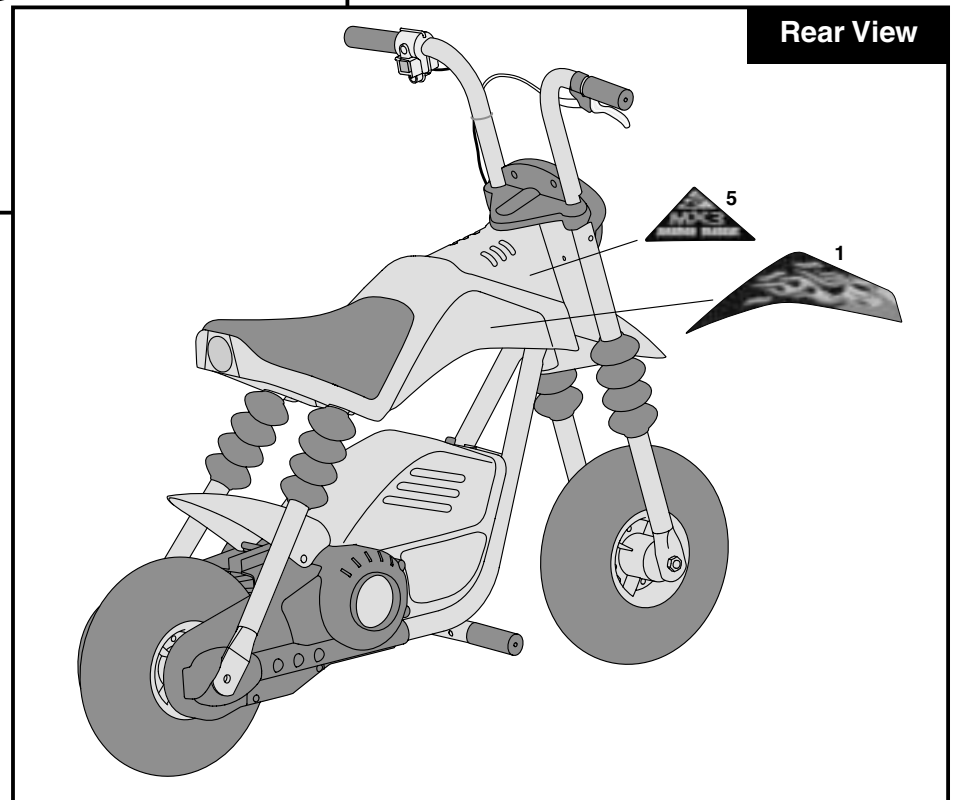
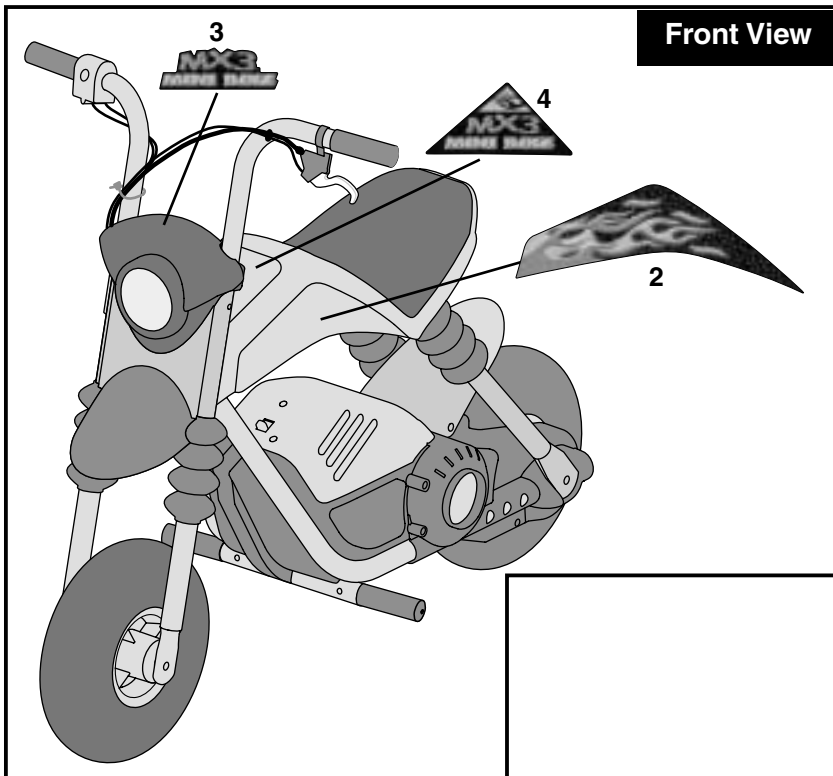

IMPORTANT! Use only a Power Wheels® 12 volt battery. Use of any other battery will damage your mini-bike. Make sure that you charge the battery for at least 18 hours using the enclosed Power Wheels® 12 volt charger before operating your mini-bike for the first time. Charge the battery for at least 14 hours after each use of the mini-bike. Never charge the battery longer than 30 hours. Failure to follow these instructions may damage your battery and will void your warranty.

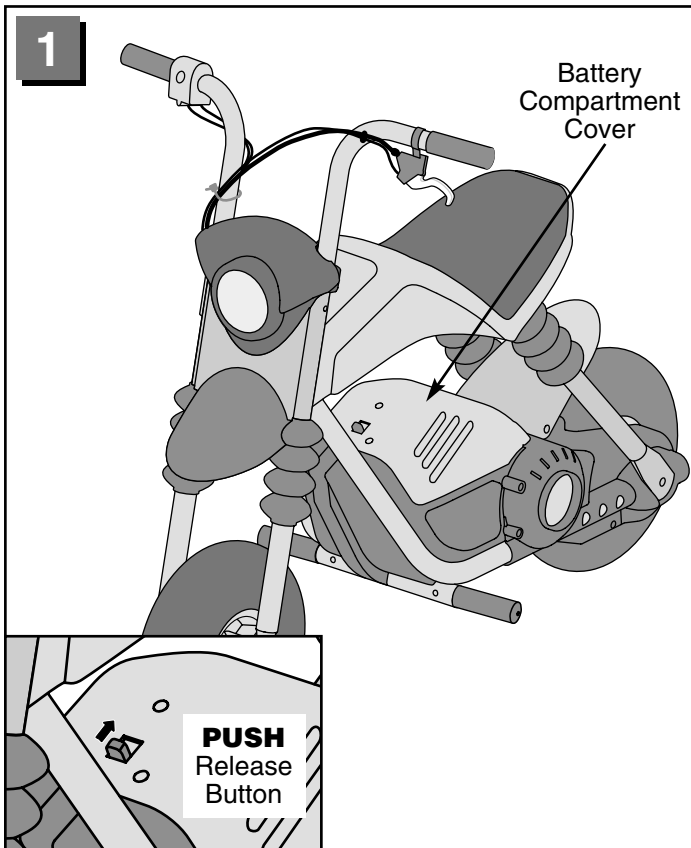

- While pushing the release button on the battery compartment cover, lift it from the mini-bike.

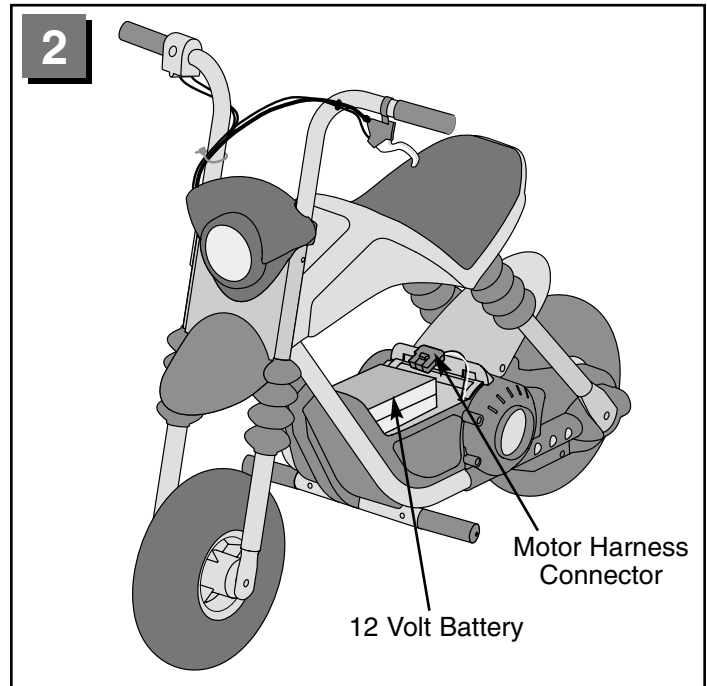

- Plug the motor harness connector into the battery socket. **Push firmly to make sure the motor harness connector is completely inserted into the battery.**
- Lower the battery into the battery compartment.

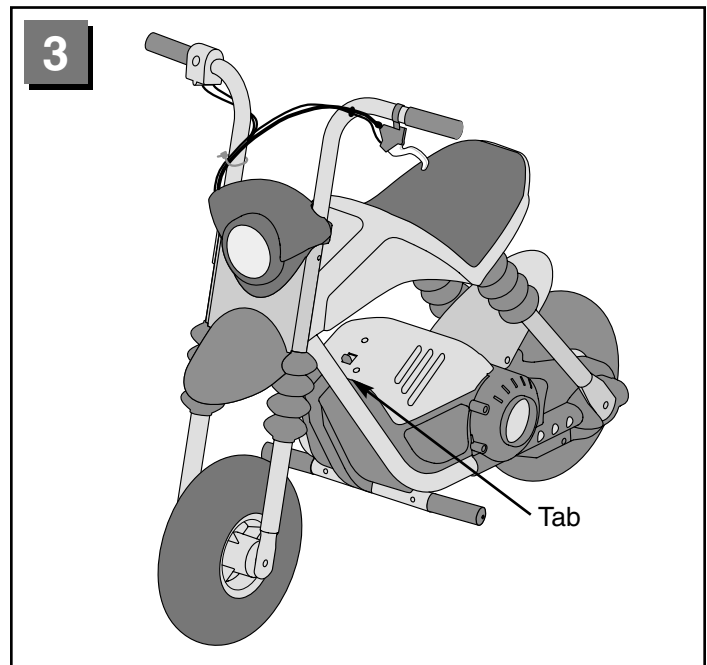

- At an angle, insert the front tab on the cover into the slot in the mini-bike floor.
- Push down on the cover to **“snap”** it into place.

Care

If a battery leak develops, avoid contact with the leaking acid and place the damaged battery in a plastic bag. See information on this page for proper disposal.

If acid comes in contact with skin or eyes, flush with cool water for at least 15 minutes and call a physician.

If acid is internally ingested, give water, milk of magnesia or egg whites immediately. Never give emetics or induce vomiting. Call a physician.

- Use only a Power Wheels 12 volt battery. Remember to charge a new battery for at least 18 hours before first use. Never charge the battery longer than 30 hours. Overcharging or undercharging the battery may shorten battery life and decrease mini-bike running time.
- After the first charge, recharge the battery for at least 14 hours after each use. Never charge the battery longer than 30 hours. Charge the battery after each use, regardless of how long the mini-bike was used.
- The battery must be upright while charging.
- Do not allow the battery to run down completely before charging.
- Charge the battery before storing the mini-bike.
- Charge the battery at least once per month, even if the mini-bike has not been used.
- Leaving the battery in a discharged condition will ruin it.
- Always remove an exhausted battery from the mini-bike. Battery leakage and corrosion can damage the mini-bike.
- Do not store the battery on a surface (such as a kitchen countertop) which could be damaged by the acid contained inside the battery. Take precautions to protect the surface on which you store the battery.
- Do not store the battery in temperatures above 75° F or below -10° F.
- Prevent the battery from moving freely inside the battery compartment. Always use the battery clamp (cover) to secure the battery in the battery compartment.
- Examine the battery, charger and its connector for excessive wear or damage each time you charge the battery. If damage is detected, do not use the charger or the battery until you have replaced the worn or damaged part.
- If the mini-bike will be stored for more than two months, be sure to disconnect the battery.

Disposal



- Your Power Wheels® battery is a sealed lead-acid battery. It must be recycled or disposed of in an environmentally sound manner.
- Do not dispose of a lead-acid battery in your regular, household trash. The incineration, landfilling or mixing of sealed lead-acid batteries with household trash is prohibited by law in most areas.
- Do not dispose of a lead-acid battery in a fire. The battery may explode or leak.
- Return exhausted batteries to a federal or state approved lead-acid battery recycler, such as a Power Wheels® authorized service center, or a local seller of automotive batteries. For the authorized service center location nearest to you, please call **1-800-348-0751**. Contact your local waste management officials for other information regarding the environmentally sound collection, recycling and disposal of lead-acid batteries. If you live in the State of Florida or the State of Minnesota, it is prohibited by law for anyone to throw away lead-acid batteries in the municipal waste stream.

IMPORTANT! Please carefully read the owner's information in this manual and teach your child about proper mini-bike operation and rules for safe riding before allowing operation of this mini-bike.

RIDING RULES



WARNING

Direct Adult Supervision Required

- To prevent injury, keep away from cars, streets, steep inclines, steps, swimming pools and other bodies of water.
- Protective equipment should be worn. Use helmet, knee pads and elbow pads (not included).
- Always wear shoes.
- Never allow more than one (1) rider.
- Never ride at night.

Teach Safety Rules to Children

While children can quickly develop the skill necessary to ride this mini-bike, it is important to remember that their judgment skills are still very immature. Unsupervised riding by children can lead to serious injury. Before children use this mini-bike, an adult should carefully evaluate the riding area as well as the children's skill level and ability to ride this mini-bike safely. Children are not always able to recognize or anticipate hazards, even when they have been taught about them. **There is no acceptable substitute for direct adult supervision.**

Teach appropriate safety rules to your child before allowing operation of this mini-bike. These rules should also be reviewed with neighborhood children or other playmates who want to ride this mini-bike.

Riding Rules

Make sure children know and follow these rules for safe riding:

1. This product is meant for outdoor use only, on private property. It should not be used on streets or other public thoroughfares.
2. Do not allow any child to ride the mini-bike in the street or near moving (motorized) vehicles.
3. Do not allow any child to ride near bodies of water (such as pools or creeks), obstructions (such as furniture, low tree limbs or play equipment), or drop-offs (such as stairs or decks).
4. Do not allow any child to ride the mini-bike in the dark. A child could encounter unexpected obstacles and have an accident. Operate the mini-bike only in the daytime or a well-lit area.
5. Do not allow your child to ride on sloped or inclined surfaces. **Restrict your child's riding to generally level ground ONLY!**
6. Do not allow your child to ride down or across a steep slope.
 - The mini-bike may gain unsafe speed.
 - The mini-bike may tilt and tip over.
 - The wheels could lose traction, causing the mini-bike to slip.
7. Do not allow your child to ride up steep inclines. The motor may stop and the mini-bike could roll backwards at an unsafe speed.
8. Never put anything near any moving parts. Rotating parts such as motor, belts, pulleys and wheels can snag fingers, hair, etc., causing serious injury. Do not allow operation of the mini-bike when it is on its side or in an upside-down position.
9. Do not operate the mini-bike near flammable vapors (gasoline, paint thinner, acetone, liquid wax, etc.). The mini-bike's electrical switches, like most electrical switches, emit an internal spark when first turned on or turned off. The presence of flammable liquids or vapors could cause an explosion or a fire. Keep all flammable products in tightly sealed containers and away from the mini-bike.
10. Do not allow a child to operate the mini-bike without direct adult supervision. To prevent unsupervised use of the mini-bike, disconnect the motor harness from the battery when the mini-bike is not in use.
11. The brake should be checked for proper function **before each use**. Check brake adjustment regularly (see page 11).

K

How to Operate Your Mini-Bike

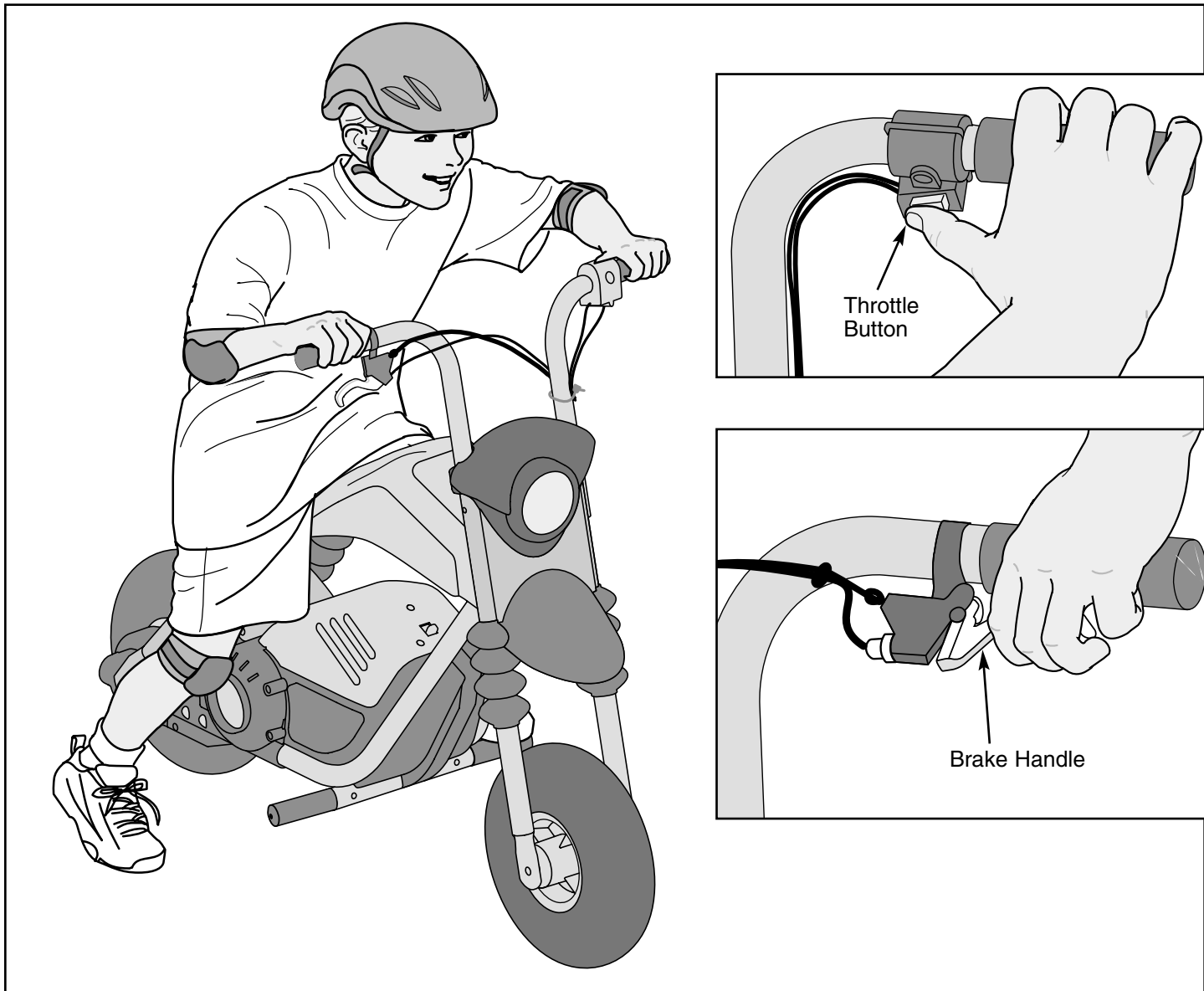

IMPORTANT! For a smooth start, place one foot on a foot peg and push off a few steps with the other foot.

- Press the throttle button and then place your other foot on the other foot peg.
- The mini-bike travels up to 7 mph (speed varies, depending on rider weight and terrain).
- To slow down or stop the mini-bike, release the throttle button and squeeze the brake handle, as shown.

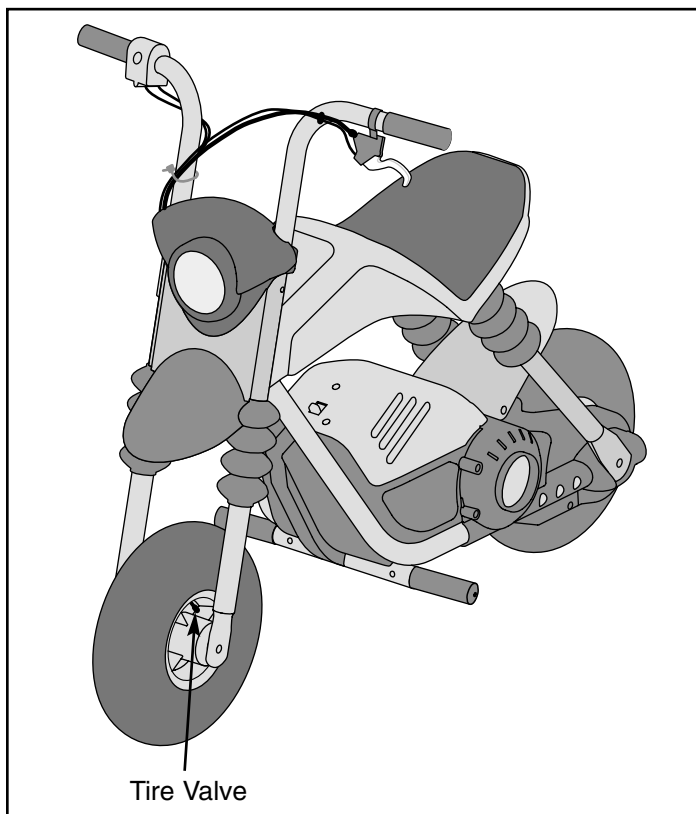

- Maximum tire air pressure is 30 lbs.
- Do not over inflate the tires.
- Check all screws, cap nuts and protective coverings regularly and tighten as required. Check plastic parts on a regular basis for cracks or broken pieces.
- During snowy or rainy weather, the mini-bike should be stored inside or under a protective cover. Remember to charge the battery at least once per month while your mini-bike is not in regular use.
- Avoid operating the mini-bike in wet or snowy conditions and do not spray the mini-bike with a hose. Do not wash the mini-bike with soap and water. Water or moisture in the motor or electrical switches can cause them to corrode and could cause switch or motor failure. Do not immerse this mini-bike.

- To prevent damage, do not use the mini-bike on wet surfaces or in wet weather. Never immerse any part of this product. Do not ride in mud. Mud can clog up the drive train system and possibly lead to the belt slipping off.
- Avoid operating the mini-bike on sand, loose dirt or gravel. Sand, loose dirt or gravel in the motors or electrical switches can cause them to jam and could cause switch or motor failure.
- The mini-bike can be wiped down with a soft, dry cloth. For a shiny finish, you can wipe plastic parts with a non-wax furniture polish applied to a soft-cloth. Do not use automotive wax. Do not use soap and water or spray the mini-bike with a hose.
- To ensure that your mini-bike stays in good operating order, we recommend that you periodically have your mini-bike checked by a Power Wheels® authorized service center. See page 23 for the list of authorized service centers or call **1-800-348-0751** for the location of the authorized service center nearest you.
- Tire repair must be done by a Power Wheels® authorized service center. See page 23 for the list of authorized service centers or call **1-800-348-0751** for the location of the authorized service center nearest you.

IMPORTANT! If you experience a problem with your mini-bike, first check the Problems and Solutions Guide below. If you still experience a problem, please contact Power Wheels® Consumer Relations, toll-free at **1-800-348-0751** between 8 AM and 6 PM (EST) Monday through Friday. Or, contact your local Power Wheels® authorized service center. For the location nearest you, please refer to the Authorized Service Center list beginning on page 23.

Problem	Possible Cause	Solution
Mini-bike does not run	Undercharged battery	Charge the battery. A new battery should have been charged for at least 18 hours before using the mini-bike for the first time. After first-time use, recharge the battery for at least 14 hours after each use. Never charge the battery longer than 30 hours.
		Check all connections. Make sure the charger connector is plugged into the battery, and that the charger is plugged into the wall.
		Make sure power flow to the wall outlet is "ON".
	Charger is not working	There is no sure way to tell if your charger is working unless you have a volt meter. If you suspect there is a problem with your charger, contact your local Power Wheels® authorized service center. They can test your charger for you.
	Tripped thermal fuse	Each Power Wheels® 12 volt battery has a built-in thermal fuse. A thermal fuse may "trip" and shut down operation of the mini-bike if the mini-bike is overloaded or the driving conditions too severe. The fuse will automatically reset itself after approximately 25 seconds, allowing the mini-bike to resume normal operation. To avoid repeated automatic shutdowns, do not overload the mini-bike by exceeding the 150 lb. maximum weight capacity or by towing anything behind the mini-bike. Do not drive up hills or run into fixed objects, which can cause the wheels to stop spinning while power is still being supplied to the motor. If a thermal fuse continually trips, contact your local Power Wheels® authorized service center.
	Loose wire or loose connectors	Check all wires and connectors. Make sure the motor harness connector is plugged into the battery, and that there are no loose wires around the motor.
	Dead battery	If your battery is old or if you have not followed Battery Care instructions, your battery may be dead. If you are unsure whether or not the battery is dead, you can have it tested at your local Power Wheels® authorized service center.
	Electrical switch damage	The electrical switches can become corroded due to exposure to water or moisture, or can jam due to loose dirt, sand or gravel. Contact your local Power Wheels® authorized service center for diagnosis and repair.
	Motor damage	Contact your local Power Wheels® authorized service center for diagnosis and repair.
	Brake is not properly adjusted	If there is a gap between the brake handle and the brake base, the mini-bike will not run. You need to adjust the brake so that it is tight, and there is no gap. Please refer to section F, <i>Adjusting the Brakes</i> , page 11.
There is a fault in the electronics that must be reset	Remove the battery compartment cover. Remove the motor harness from the battery. Then, replace the motor harness back into the battery. Replace the battery compartment cover.	

Problems and Solutions Guide

Problem	Possible Cause	Solution
Mini-bike was running but suddenly stopped	Loose wire or loose connectors	Check all wires and connectors. Make sure the motor harness connector is plugged into the battery, and that there are no loose wires around the motor.
	Low battery voltage; battery needs charging	Charge the battery. A new battery should have been charged for at least 18 hours before using the mini-bike for the first time. After first-time use, recharge the battery for at least 14 hours after each use. Never charge the battery longer than 30 hours.
	Tripped thermal fuse	Each Power Wheels® 12 volt battery has a built-in thermal fuse. A thermal fuse may "trip" and shut down operation of the mini-bike if the mini-bike is overloaded or the driving conditions too severe. The fuse will automatically reset itself after approximately 25 seconds, allowing the mini-bike to resume normal operation. To avoid repeated automatic shutdowns, do not overload the mini-bike by exceeding the 150 lb. maximum weight capacity or by towing anything behind the mini-bike. Do not drive up hills or run into fixed objects, which can cause the wheels to stop spinning while power is still being supplied to the motor. If a thermal fuse continually trips, contact your local Power Wheels® authorized service center.
	Brake is not properly adjusted	If there is a gap between the brake handle and the brake base, the mini-bike will not run. You need to adjust the brake so that it is tight, and there is no gap. Please refer to section F, <i>Adjusting the Brakes</i> , page 11.
Short run time (less than 1 - 3 hours per charge)	Undercharged battery	Charge the battery. A new battery should have been charged for at least 18 hours before using the mini-bike for the first time. After first-time use, recharge the battery for at least 14 hours after each use. Never charge the battery longer than 30 hours.
		Check all wires and connections. Make sure the charger connector is plugged into the battery, and that the charger is plugged into the wall.
		Make sure power flow to the wall outlet is "ON".
		There is dirt or residue on the metal contact on the charger connector. Remove the dirt or residue with an eraser.
	Overcharged battery	Do not charge the battery longer than 30 hours. If you suspect that your battery is damaged as a result of overcharging, contact your local Power Wheels® authorized service center. They can test your battery for you.
	Battery is old and will not accept full charge	Even with proper care, a rechargeable battery does not last forever. Average battery life is 1 to 3 years depending on mini-bike use and use conditions. Replace the battery with a new Power Wheels® 12 volt rechargeable battery. Do not substitute parts.
Tripped thermal fuse	Each Power Wheels® 12 volt battery has a built-in thermal fuse. A thermal fuse may "trip" and shut down operation of the mini-bike if the vehicle is overloaded or the driving conditions too severe. The fuse will automatically reset itself after approximately 25 seconds, allowing the mini-bike to resume normal operation. To avoid repeated automatic shutdowns, do not overload the mini-bike by exceeding the 150 lb. maximum weight capacity or by towing anything behind the mini-bike. Do not drive up hills or run into fixed objects, which can cause the wheels to stop spinning while power is still being supplied to the motor. If a thermal fuse continually trips, contact your local Power Wheels® authorized service center.	

Problems and Solutions Guide

Problem	Possible Cause	Solution
Mini-bike runs sluggishly	Undercharged battery	Charge the battery. A new battery should have been charged for at least 18 hours before using the mini-bike for the first time. After first-time use, recharge the battery for at least 14 hours after each use. Never charge the battery longer than 30 hours.
		Check all connections. Make sure the charger connector is plugged into the battery, and that the charger is plugged into the wall.
		Make sure power flow to the wall outlet is "ON".
	Battery needs charging	Be sure to charge the battery after each use.
	Battery is old and will not accept full charge	Even with proper care, a rechargeable battery does not last forever. Average battery life is 1 to 3 years depending on the mini-bike use and use conditions. Replace the battery with a new Power Wheels® 12 volt rechargeable battery. Do not substitute parts.
	Mini-bike is overloaded	Make sure you do not overload the mini-bike by allowing more than 1 rider at one time, by exceeding the 150 lb. maximum weight capacity, or by towing objects behind the mini-bike.
	Driving conditions are too stressful	Use only on generally level ground.
Sometimes the mini-bike doesn't run, but other times it does	Loose wire or connector	Check all wires around the motors and all connectors to make sure they are tight.
	Motor or electrical switch damage	Contact your local Power Wheels® authorized service center for diagnosis and repair.
	Brake is not properly adjusted	If there is a gap between the brake handle and the brake base, the mini-bike will not run. You need to adjust the brake so that it is tight, and there is no gap. Please refer to section F, <i>Adjusting the Brakes</i> , page 11.
When the throttle button is pressed, the mini-bike won't run without a push	Loose wire or connector	Check all wires around the motor and all connectors to make sure they are tight.
	"Dead Spot" on motor	Contact your local Power Wheels® authorized service center for diagnosis and repair.
Charger gets warm during use	It is normal for some chargers to get warm during use and is not reason for concern.	No action required.
		If your charger does not get warm during use, it does not mean that it is not working properly.
Battery makes a sizzling or gurgling noise when charging	It is normal for some batteries to make noise and swell slightly while charging and is not reason for concern.	No action required.
		If your battery does not make noise or swell slightly during charging, it does not mean that it is not accepting the charge.

If, after reviewing the Problems and Solutions Guide, the mini-bike still fails to operate, please contact your nearest authorized service center (see page 23) or contact Power Wheels® Consumer Relations toll-free at **1-800-348-0751**.

Hint: For faster service when calling Consumer Relations, completely charge the battery before calling and have the following available by the phone:

- mini-bike,
- mini-bike model number (see label in battery compartment),
- mini-bike production run number (see label in battery compartment).

N

Limited Warranty

***One year limited warranty from the date of purchase on the Power Wheels® vehicle.
Six month limited warranty on the 12 volt battery.**

For the original purchaser, this one year limited warranty covers the Power Wheels® ride-on vehicle (purchased from Power Wheels®) against defects in materials and workmanship. The six month limited warranty applies only to the 12 volt battery included by Power Wheels® with the original purchase of the vehicle.

This warranty covers normal use and does not cover the Power Wheels® vehicle or battery if damaged by unreasonable use, neglect, accident, abuse, misuse, improper service or other causes not arising out of defects in materials or workmanship. Evidence of any attempt at consumer repair will void this warranty. THIS WARRANTY DOES NOT COVER, AND IS INTENDED TO EXCLUDE, ANY LIABILITY ON THE PART OF POWER WHEELS®, WHETHER UNDER THIS WARRANTY OR IMPLIED BY LAW OR ANY INDIRECT OR CONSEQUENTIAL DAMAGES FOR BREACH OF WARRANTY. SOME STATES DO NOT ALLOW THE EXCLUSION OR LIMITATION SO THIS LIMITATION MAY NOT APPLY TO YOU.

Should you need service or assistance with your vehicle during the warranty period, **do not return the vehicle to the store.** Power Wheels® has provided a nationwide network of authorized service centers. Please refer to the list in this manual. Power Wheels® is continually expanding our Authorized Service Center Network. If there is not an authorized service center in your area, please call Consumer Relations for information, **1-800-348-0751**.

This warranty gives you specific legal rights, and you may also have other rights which may vary from state to state. **Please save your original sales receipt.**



Authorized Service Centers

We are continually expanding our Authorized Service Center Network. Please check this listing for the independently owned and operated Authorized Service Center nearest you. If there is not one in your area, please call Power Wheels® Consumer Relations at 1-800-348-0751.

ALABAMA

BIRMINGHAM - Frigid Service & Sales, 701 Graymont Ave. North, 35203, (205) 323-5831
BIRMINGHAM - Frigid Service & Sales, 1861 Centerpoint Rd., 35215, (205) 853-3952
BIRMINGHAM (HOMEWOOD) - Frigid Appliance Center, 154 West Valley Ave., 35209, (205) 942-3959
DECATUR - Peddler II, 1000 B Beltline Road, 35603, (205) 350-1044
DOTHAN - Bill's Appliance Service, 208 Bic Road, P.O. Box 1192, 36303, (334) 792-7746
DOUGLAS - Brown Hardware, Highway 75, 35964, (205) 593-6086
HUNTSVILLE - C & G Appliance, 307 Jordan Lane, 35805, (205) 837-4551
MOBILE - Foster's Appliance Repair, 2610 Halls Mill Road, 36606, (251) 479-3567
NORTHPORT - Appliance Connection, 2703 McFarland Blvd, 35476, (205) 339-2774
TROY - Specialty Batteries, 1317 S. Brundidge St., P.O. Box 1045, 36081, (334) 670-6800

ALASKA

FAIRBANKS - Appliance Service Co. Inc., 700 23rd Ave., 99701, (907) 452-1000

ARIZONA

GLENDALE - Elliott Electric Appliance Service, 6242 N. 43rd Avenue, 85301, (623) 937-2613
SCOTTSDALE - Elliott Electric, 7515 E. McDowell Road, 85257, (480) 946-7487

ARKANSAS

FT. SMITH - Bromley Appliance Service, 614 North 10th Street, 72901, (479) 782-9646
GLENWOOD - Gardening Plus, 110 North 2nd Street, 71943, (870) 356-2233
JONESBORO - Best Sewing & Vacuum & Repair, 2235 S. Caraway Road, 72401, (501) 935-4739, (800) 844-4739
LITTLE ROCK - C & W Tool Repair, 1303 W. Markham, 72201, (501) 374-1911
ROGERS - Kressel's Vacuum & Repair, 115 North 5th Street, 72756, (479) 636-7894
STUTTGART - Davis Lumber Company, 301 East Michigan, 72160, (501) 673-3601

CALIFORNIA

BAKERSFIELD - Southwest TV, 6300 White Lane, Suite B, 93309, (805) 397-4940
CONCORD - CES Concord, 1170G Burnett Avenue, 94520, (925) 827-1011
COVINA - CES Covina, 612 S. Shoppers Lane, 91723, (626) 915-4935
ESCONDIDO - Mart's Appliance Service, 743 E. Valley Parkway, 92025, (760) 745-7711, (800) 313-7715
FRESNO - Valley Small Appliance, 4005 E. Ashlan Avenue, 93726, (209) 224-5530
FULLERTON - CES Fullerton, 1208 East Ash Avenue, 92631-5020, (714) 870-0900
LAKE FOREST - California Electric Service, 22500 Muirlands Suite B, 92630, (949) 586-9440
LOS ALAMITOS - Folsom Electric, 11284 Los Alamitos Blvd., 90720, (562) 596-7895
OXNARD - J&M Vacuum, 1237 Saviers Road, 93033, (805) 486-1244
SALINAS - SRS Hobbies, 407 Front Street, 93901, (831) 424-4044
SANTA ROSA - Hardisty's Inc., 1565 Farmers Lane, 95405, (707) 545-0535
SKY FOREST - Sky Forest Electrical, 28670 Highway 18, P.O. Box 496, 92385, (909) 337-0811
VENTURA - Appliance Advantage, 4547 Telephone Rd., Suite A, 93003, (805) 650-0716, (800) 960-2125
YUCAIPA - Aire-Rite Heating & A/C, 34724 Yucaipa Blvd., 92399, (909) 797-2788

COLORADO

COLORADO SPRINGS - Nelson Appliance Repair, Inc., 1220 E. Fillmore, 80907, (719) 635-1928, (800) 291-8010
DENVER - Appliance Service, 4272 Lowell Blvd., 80211, (303) 458-1109
GRAND JUNCTION - V & L Appliance Service, 591 25 Road Suite A6, 81505, (970) 243-3360
PUEBLO - Direct Maytag Home Appliance, 1407 Santa Fe Drive, 81006, (719) 543-0777
HARTFORD - Hartford Element & Appliance Service, 1500 Albany Ave., 06112, (860) 246-7424, (800) 787-7977
NEW HAVEN (HAMDEN) - New Haven Appliance Service Center, 1627 Dixwell Ave., 06514, (203) 288-6229
SHELTON - Jeff's Appliance & Vacuums, 66 Center Street, 06484, (203) 924-8997
STAMFORD - Appliance Servicer of Stamford, 15 Cedar Heights Road, 06905, (203) 322-7656

CONNECTICUT

WILMINGTON - Lyons Hardware, Inc., 2021 Kirkwood Highway, 19805, (302) 995-1260

FLORIDA

ATLANTIC BEACH - First Coast Repair, 25 Seminole Road, 32233, (904) 246-4616
BOYNTON BEACH - Discount Vacuum, 1865 W. Woolbright Road, 33425, (561) 243-9999
CALLAHAN - Arc Electronic Repair, 1844B South Kings Road, 32011, (904) 879-3556
CAPE CORAL - Family Hardware/Do-It Express, 622 SE 47th Terrace, 33904, (941) 542-6365
DELRAY - Mister Fix It, 209 S.E. 2nd Avenue, 33483, (561) 243-9999
GAINESVILLE - Authorized Appliance Service Co., 2614 S.W. 34th Street, 32608, (352) 375-3886
JACKSONVILLE - Authorized Appliance Service Co., 6120-5 Powers Avenue, 32217, (904) 737-5312
LAKECITY - S&S Mowers Inc., RT. 10, Box 35916, 32025, (904) 755-2957
LAKELAND - Electric Shaver & Small Appliance, 4243 S. Florida Avenue, 33813, (863) 644-4690
MIAMI - Goodman's Sales & Service, 13130 SW 128 Street #3, 33186, (305) 278-8822
NORTH PALM BEACH - Appliance Doctors, 450 Northlake Blvd., 33408, (407) 845-0377
OCALA - Vacuums Center and Gifts, 422 South Pine Street, #103, 34474, (352) 732-6335

ORLANDO - Southern Electric Co., 510 N. Parramore Avenue, 32801, (407) 841-8824, (800) 940-8824
PANAMA CITY - Callaway Vacuum & Sewing, 221 N. Tyndall Prkwy., 32404, (850) 763-6333
PENSACOLA - Foster's Appliance Repair, 3836 N. Davis Highway, 32503, (904) 432-8853
POMPANO BEACH - Authorized Appliance, 2171 N. Dixie Highway, 33060, (954) 941-2038
PORT ST. LUCIE - Appliance Doctors, 10632 South Federal Hwy, 34952, (772) 337-0708

SARASOTA - Sunray Small Appliances, 8371 N. Tamiami, 34243, (941) 358-9999, (800) 895-5655
SEBRING - Ace Hardware Of Sebring, 305 U.S. 27 North, 33870, (863) 385-2735
SPRING HILL - Ace Hardware #5304F, 5350 Spring Hill Dr., 34606, (352) 686-4743
SPRING HILL - National Floor Care, 5588 Commercial Way, 34606, (352) 686-6711, (800) 245-1946

ST. PETERSBURG - Keystone Electric, 4604 Central Avenue, 33711, (813) 321-1124
STUART - Appliance Doctors, 3166 S.E. Dixie Highway, 34997, (772) 287-6437

SUNRISE - Muller Appliance Service, 2116 North University Drive, 33322, (954) 749-5460

TALLAHASSEE - Dougs Vacuum Center, 604 N. Bronough Street, 32301, (850) 222-1423
VERO BEACH - Hoppe's Authorized Vacuum and Appliance, 1872 Commerce Ave., 32960, (561) 562-4466
WEST PALM BEACH - Satisfaction TV Video, 1980 South Congress Ave., 33406, (561) 439-3733, (800) 477-3734

GEORGIA

BRUNSWICK - Arco Hardware & Supply, 3711 Community Road, 31520, (912) 267-0771
COLUMBUS - Burrell's National Appliance Service, 1728 Warm Springs Road, 31904, (706) 327-0523
NORCROSS - Appliance Connection, 5172-C Brook Hollow Parkway, 30071, (770) 734-9888, (800) 964-7455
GAINESVILLE - Bike Town USA, 1604 Dawsonville Highway, 30501, (770) 532-7090
MABLETON - Cool-It Auto Air Inc., 1480 S. W. Veterans Memorial Hwy Suite B, 30126, (770) 819-0102
SAVANNAH - Hagins Appliance Service, 3 West Victory Drive, 31405, (912) 233-8372
THOMASVILLE - Carroll Hill Auto, 115 Albany Road, 31799, (229) 266-0717
VALDOSTA - Harry B. Anderson, Inc., 204 E. Central Avenue, 31601, (229) 242-5945
WOODSTOCK - All City Appliance Inc., 8477 Highway 92 Suite 110, 30189, (770) 924-2375

HAWAII

HONOLULU - McCully Bicycle & Sporting Goods, 932 Hausten Street, 96826, (808) 946-1192
WAILUKU (MAUI) - Tom's Appliance Sales & Service, 1816 Mill Street, Suite 104, 96793, (808) 244-6278
WAIPAHU - Gary's Bike World, 94-910 Moloalo Street, 96797, (808) 375-4262

IDAHO

BOISE - Boise Appliance, 7539 W. Mossy Cup Street, 83709, (208) 343-0102
IDAHO FALLS - Rossiter Electric, 1501 South Capital Avenue, 83402, (208) 529-3665

ILLINOIS

CHICAGO (BERWYN) - Brand Service Center, 6739 West Cermak, 60402, (708) 749-4315
CHICAGO (DOWNER'S GROVE) - Authorized Appliance Service Co., 1644 W. Ogden Avenue, 60515, (630) 852-1550
CHICAGO (MORTON GROVE) - Brand Service Center, Inc., 5618 Dempster Street, 60053, (847) 965-5900
DECATUR - Rexx Battery of Decatur, Inc., 1330 East Eldorado, 62521, (217) 422-0281
EAST DUNDEE - R & R Small Engine Repair, 305 Johnston Street, 60118, (874) 428-0023
FAIRVIEW HEIGHTS - Rapid Rentals, 720 Lincoln Highway, 62087, (618) 632-0630
GRANITE - Midwest Golf Car & Equipment Co., 904 Thorngate Road, 62040, (618) 797-2278
HAMILTON - Discount Battery Sales, #80 S 2nd Rte. 136, 62341, (217) 847-3242
JACKSONVILLE - Rexx Battery Specialists, 847 South Main Street, 62650, (217) 245-2713
LINCOLN - Rexx Battery Specialists, 504 Keokuk, 62656, (217) 732-2885
MT. VERNON - Battery Specialists, 1018 South 10th Street, 62864, (618) 244-0091
NASHVILLE - Kesel Hardware, 173 West St. Louis, 62263, (618) 327-8957
NILES - Household Appliance Sales & Serv., 7411 N. Milwaukee Ave., 60714, (847) 647-8250
SPRINGFIELD - Bannon Electronics, 1224 N. Franklin, 62702, (217) 523-0313
TAYLORVILLE - Battery Specialists + Golf Cars, 800 Springfield Road, 62568, (217) 824-3943

Authorized Service Centers

INDIANA

EVANSVILLE - Electro Hygiene Co., 1614 S Kentucky, 47714, (812) 425-2671
FT. WAYNE - Southside Vacuum Co. Inc., 3702 South Calhoun Street, 46807, (260) 745-7788, (888) 209-8113
INDIANAPOLIS - Brand Service Center, 1827 N. Meridian Street, 46202, (317) 924-1386
INDIANAPOLIS - Sullivan Hardware Do-It Center, 7021 N. Keystone, 46220, (317) 255-9230
NEW ALBANY - Wells Hardware, Inc., 1011 Vincennes Street, 47150, (812) 944-4523
SOUTH BEND (OSCEOLA) - AAA Appliance Service Co., 11868 Lincoln Way West, 46561, (1704) 679-4981
TERRE HAUTE - Corey Electronics, 1101 S. 8th Street, 47802, (812) 232-8786, (888) 232-8786
VINCENNES - Organ Battery & Electric Co. Inc., 1434 S. 15th Street, P.O. Box 391, 47591, (812) 822-6474, (877) 882-7172

IOWA

BETTENDORF - K & K True Value Hardware, 1818 Grant Street, 52722, (563) 359-4473
CEDAR RAPIDS - Stalker Electric, Inc., 110 3rd Ave. SW, 52404, (319) 364-5646
COUNCIL BLUFFS - Millard Television Inc., 1840 Madison Avenue, 51501, (712) 322-9552
DES MOINES - Quality Appliance Repair Center, 1417 Walnut Street, 50309, (515) 288-0108
DUBUQUE - Shaver's Plus, 450 Central Avenue, 52001, (563) 556-4442
FT DODGE - Messerly Electronics, 1234 Central Avenue, 50501, (515) 576-4480
GRINNELL - Bikes To You Inc., 921 Broad Street, 50112, (515) 236-8600
MARSHALLTOWN - Blink Electric Motors, Inc., Rear 116 N 1st Avenue, 50158, (641) 752-3036
NORTH LIBERTY - Ace Electric, Inc., 165 Hwy 965 NE, 52317, (319) 626-3007, (800) 326-3007
SIoux CITY - Millard Television Inc., 1419 Hamilton Blvd., 51103, (712) 258-3435

KANSAS

CHANUTE - Zimmerman Electric Service, 1202 West Beech, P.O. Box 533, 67720, (620) 431-2260, (800) 362-0909
COLBY - Gavon's Electronics, 1870 South Range, 67701, (913) 462-6601
JUNCTION CITY - R/C Hobbies, 115 W. 7th Street, 66441, (913) 238-1877
KANSAS CITY (OVERLAND PARK) - Mar-Beck Appliance Service Co., 8471 West 95th Street, 66212, (913) 642-1557
SPEARVILLE - Quality Parts, P.O. Box 126, 406 North Main, 67876, (316) 385-2624
WICHITA - Alan Appliance Service, Inc., 1300 E. Central, 67214, (316) 262-7228, (800) 290-7228

KENTUCKY

GREENVILLE - Malone Lumber Do-It Center, 204 W. Depot Street, 42345, (270) 338-3252
LEXINGTON - AutoHobby Model Raceway, 1474 Anniston Drive, 40505, (859) 299-4925
LOUISVILLE - Maury's Fluorescent & Appliance Service, 1521 Bardstown Road, 40205, (502) 456-1671
OWENSBORO - Kuester's Hardware, 1210 Carter Road, 42301, (270) 685-4916
PADUCAH - Hank Brothers True Value, 3101 Lone Oak Rd., 42003, (270) 554-4001

LOUISIANA

BAKER - Gayle Battery Distributors, 16555 Plank Road, 70714, (225) 774-7475
BATON ROUGE - Home Appliance Service, Inc., 10781 Florida Blvd., 70815, (504) 272-7727
COVINGTON - Battery World LLC, 1601 N. Hwy 190 Suite A, 70433, (985) 809-9300
HAMMOND - Battery Depot, 2323 Hwy 190 East Suite #4, 70401, (985) 542-4952
NEW ORLEANS (METAIRIE) - Le Jouet, Inc., 1700 Airline Hwy., 70001, (504) 837-0533
SHREVEPORT - Shreveport Shaver and Appliance, 9750 St. Vincent, Burt Koums Ind. Loop, 71106, (318) 865-5088, (800) 349-7722

MAINE

GREENE - MAC (Maine Accessibility Corp), 87-89 Hillside Avenue, 04401, (207) 947-2357
GREENE - Brule's Auto Clinic & Sales, 968 Sawyer Road, 04236, (207) 375-4872
PERU - Mountain Valley Sports, 58 Ridge Road, 04290, (207) 562-7164
PORTLAND - Colonial Electronics, Inc., 259 St. John Street, 04102, (207) 774-6666

MARYLAND

ABERDEEN - Burkheimer Garden Equipment, 651 Gilbert Road, 21001, (410) 734-4577
BALTIMORE - Colgate Hardware, 6711 Holabird Ave., 21222, (410) 633-6363
BERLIN - Myers Auto-Power Tool Rental Co., Inc., 10714 Ocean Gateway, 21811, (410) 641-3497
GAITHERSBURG - Waters Appliance Service, 216 E. Diamond Avenue, 20877, (301) 258-7500, (800) 225-5009
GLEN BURNIE - Taylor Rental, 7389 Baltimore Annapolis Blvd., 21061, (410) 768-1933, (800) 836-8464
LOVEVILLE - Hancock Refrigeration Co Inc., 28650 Point Lookout Rd, 20656, (301) 475-8298

MASSACHUSETTS

BOSTON (MEDFIELD) - Wills Hardware, 5 Janes Avenue, 02052, (508) 359-4381
LOWELL - Lowell Appliance Service Center, Inc., 564 Dutton Street, 01854, (508) 454-8731
MAYNARD - Gramp's Garage, 16 Main Street, 01754, (508) 461-0463
NEEDHAM - Suburban Appliance Service Center, 34 Wexford Street, 02492, (781) 449-8787
QUINCY - Appliance Service and Parts, Inc., 582 Washington Street, Rt. 3A, 02169, (617) 773-6656
SALEM - Fix Master, Inc., 190 North Street, 01970, (508) 745-0004
SPRINGFIELD - Utility Electric Service, Inc., 810 Main Street, 01101, (413) 781-1635

MICHIGAN

ALMA - JTS Electronics, LLC, 306 East Center Street, 48801, (989) 463-5871
ALMONT - Almont Do It Center #5336, 4545 Vandyke, 48003, (810) 798-8922
BAY CITY - Bay Vac & Pedal, 805 Columbus Ave., 48708, (989) 892-7516
BRIGHTON - Complete Battery Source, 8023 W. Grand River, 48116, (810) 220-1050
DEARBORN - McNichols Electric Service, 1836 Grindley Park, 48124, (313) 563-7550
DETROIT - McNichols Electric Service, 13725 W. McNichols, 48235, (313) 342-6070, (800) 562-4226
DETROIT (ROYAL OAK) - McNichols Electric Service, 4115 West 13 Mile Road, 48072, (810) 288-5135
FLINT (DAVISON) - Gill-Roy's Hardware, 8405 E Davison, 48423, (810) 653-2288
FLINT (SWARTZ CREEK) - Gill-Roy's Hardware, 9061 Miller Road, 48473, (810) 635-2020
GAYLORD - Alpine Electronics, 604 West Main, 49735, (989) 732-5004, (800) 244-6633
GRAND RAPIDS - Superior Appliance Service Co., 1050 Scribner Avenue, NW, 49504, (616) 459-3271
HOLLAND - A-1 Used Mowers, 96 Howard Avenue, 49424, (616) 396-0002
JACKSON - Hammond Hardware, 1800 Francis St., P.O. Box 7, 49204, (517) 782-0704
LANSING - Rapid Appliance Service, 1606 E. Michigan Avenue, 48912, (517) 485-1320
MARLETTE - Thumb Appliance and Retail Center, 3441 Main Street, 49684, (989) 635-7848
MIDLAND - Gill-Roy's Complete Hardware, 3128 Jefferson Ave., 48640, (989) 832-2774
PAW PAW - Electronic Care Inc., 238 E. Michigan Avenue, 49079, (616) 657-2129
PRUDENVILLE - Ford's Do-It Center, 841 W. Houghton Lake Drive, 48651, (517) 366-7622
ROYAL OAK - McNichols Electric Service, 4115 Thirteen Mile Road, 48072, (248) 288-5135
TRAVERSE CITY - Gil-Roy's Hardware, 2701 Zimmerman Road, 49684, (231) 929-8160

MINNESOTA

BLAINE - Barnes #1, 8701 Central Ave. NE, 55434, (763) 780-7229
BRAINERD - Git A'Round, 4299 Hwy. 371 North, 56401, (218) 828-8088
DULUTH - All Brand Mr. Fixit, 16 West First Street, 55802, (218)-722-1499
SAUK CENTRE - T & M Electric, 625 Lincoln Loop, 56378, (320) 352-6839
ST. PAUL - Barnes, 1573 University Avenue, 55104, (612) 646-3109
MISSISSIPPI
HATTIESBURG - Champion Cycle & Fitness, 2625 Lincoln Road, 39402, (601) 310-0270
IUKA - W. H. Fairless Hardware Co., Inc., 117 Fulton Street, 38852, (662) 423-9256, (800) 797-9457
JACKSON (RIDGELAND) - Propeller Service, 291 Hwy. 51, Suite D6, 39157, (601) 856-3191
LONG BEACH - Walker Rent All & Hardware, 19079 Pineville Road, 39560, (228) 864-0864
SALTILLO - Polaris Outdoor World, 3463 Tom Watson Drive, 38866, (662) 680-4733
STARVILLE - East Mississippi Lumber Co., 300 Russell Street, 39759, (662) 323-3554

MISSOURI

GLADSTONE - Mar-Beck Appliance Service Co., 6559 North Oak Traffic Way, 64118, (816) 436-9191
INDEPENDENCE - Mar-Beck Appliance Service Co., 4476 South Noland Road, 64055, (816) 478-1889
KANSAS CITY - Mar-Beck Appliance Service Co., 303 W. 79th Street, 64114, (816) 523-6931
POPLAR BLUFF - Mills Iron & Supply, 1919 S. Westwood Blvd., 63901, (573) 785-2628
ST. LOUIS - Authorized Appliance, Inc., 2355 Hampton Avenue, 63139, (314) 647-4250

MONTANA

BILLINGS - Radio Equipment Company, 1120 16th Street West, 59104, (406) 256-9778, (800) 711-4024

NEBRASKA

GRAND ISLAND - Mundt's Small Appliance & Vacuum Repair, 1822 W. Northfront Street, 68803, (308) 382-5084
LINCOLN - CB Small Appliance, 432 South 11th Street, 68508, (402) 475-2546
LINCOLN - Sperry TV, 1115 North 47th St., 68503, (402) 464-9181
NORTH PLATTE - Sperry TV, 1855 West A Street, Westfield Shopping Center, 69010, (308) 532-5200
OMAHA - Myers Electric Co., 7342 Farnam, 68114, (402) 393-8388, (800) 234-1414

NEVADA

LAS VEGAS - Burney's Commercial Service, Inc., 4480 Aldebaran Avenue, 89103, (702) 736-0006
MINDEN - Valley Home & Sport Center, 1587 Highway 395, 89423, (775) 782-5111

NEW HAMPSHIRE

MARLBOROUGH - Electronics Aid Inc., 32 Roxbury Road P.O. Box 325, 03455, (603) 876-4161

NEW JERSEY

DENVILLE - Ranft's Denville Vacuum & Appliance, 12 Broadway, 07834, (973) 627-1156
HAWTHORNE - Ter Kuile, Inc., 206 Diamond Bridge Avenue, 07506, (201) 423-1142
HIGHLAND PARK - Dash Electronics, 10 North Second Ave, 08904, (732) 247-2495
HOWELL - South Jersey TV Service, Inc., 4232 Rt. 9 South, 07731, (908) 363-5550, (800) 244-3094
SOUTHAMPTON - Southampton Auto Center, 1831 Rt. 206, 08088, (609) 859-3987, (609) 859-3341
SICKLERVILLE - Sicklerville Hardware, 540 Williamstown Road, 08081, (856) 728-3800
TOMS RIVER - South Jersey TV Service, Inc., Stella Towne Center, 1258 Rt. 166, 08753, (908) 505-1771
TRENTON - Tattersall, Inc., 309 N. Willow Street, 08618, (609) 393-4293

NEW MEXICO

ALBUQUERQUE - Appliance Service Center, 3219 Candelaria, NE, 87107, (505) 265-7774
CLOVIS - Burns Hardware, 1511 N. Prince, 88101, (505) 769-2528

Authorized Service Centers

NEW YORK

ALBANY - Lake Electronic Service, 1650 Central Avenue, 12205, (518) 869-8424, (800) 585-3777
BAYSHORE, L.I. - Turnpike Appliance of Suffolk, Inc., 1253 Sunrise Highway, 11706, (631) 665-8311
BRONX - Home Appliance Vacuum Word, 5902 Riverdale Avenue, 10471, (718) 884-4600
BUFFALO (WILLIAMSVILLE) - Hector's Hardware, 876 Maple Road, 14221, (716) 688-4488
BUFFALO (HAMBURG) - K-Technologies, 5424 Abel Road, 14075, (716) 649-5460
COMMACK, L.I. - Turnpike Appliance Service, 6181 Jericho Turnpike, 11725, (631) 499-3355
EAST AURORA - Sem-Fab of Western New York, 150 Elm Street, 14052, (716) 655-5228
ELMIRA - Capabilities, Inc., 1149 Sullivan Street, 14901, (607) 734-2006
HAMBURG - The Battery Post Inc., 4109 St. Francis Drive, 14075, (716) 824-1987
HOWARD BEACH - Crossbay Appliance Service, 158-34 Crossbay Blvd, 11414, (718) 843-4422
MONTICELLO - Wayne's Small Engine, 66 St. John Street, 12701, (845) 796-1851
OCEANSIDE - Turnpike Appliance Service, 3495A Lawson Boulevard, 11572, (516) 486-5700
POUGHKEEPSIE - S & S Appliance Sales & Service, 420 Violet Avenue, 12601, (845) 452-6122
RICHMOND HILL - Lockdoctor Locksmiths, 104-37 Atlantic Ave., 11418 (718) 441-6242
ROCHESTER - Benfante Appliance Service, 1286 Mt. Hope Avenue, 14620, (585) 473-8765
SYRACUSE - County Wide Appliance, 1001 N. State Street, 13208, (315) 479-5253, (877) 479-5253
TUCKAHOE - Authorized Appliance of Westchester, 26 Columbus Ave., 10707, (914) 961-8011
WARWICK - Wadson Home Center, 60 Forester Ave., 10990, (845) 987-2215, (800) 982-2215 (NY only)
YORKVILLE - Yorkville Battery Inc., 126 Whitesboro Street, 13495, (315) 736-2307

NORTH CAROLINA

ANDREWS - Smoky Mountain Hobbies, 13956 US 19 White's Plaza, 28901, (828) 321-9836
ASHEVILLE - Skyland Hardware, 3179 Sweeten Creek Road, 28803, (704) 684-0308
CHARLOTTE - Authorized Appliance Servicenter, 1020 Tuckaseegee Road, 28208, (704) 377-4501, (800) 532-6127
CLINTON - Danny's Service Center, 119 Vance Street, 28328, (910) 592-3200
ELIZABETH CITY - Coastal Office Equipment Co., 501 East Church Street, 27909, (919) 335-2927
GREENSBORO - Eclipse Services, 3310 N. Church Street, 27406, (336) 375-9809
HICKORY - Power Tool & Electric Equipment, 442 Highland Avenue S.E., 28602, (828) 327-8400
JACKSONVILLE - Discount Sales and Service, 468-B Western Blvd., 28456, (910) 455-6700
RALEIGH - A-1 Appliance & Shaver Service, 2940-13 Travick Road, 27604, (919) 872-8004
WILMINGTON - Coastline Mower/Coastline Mower, 301-C N. Green Meadows Drive, 28405, (910) 313-0051
WINSTON-SALEM - Authorized Appliance Service Center, 904 S. Marshall Street, 27117, (910) 725-5396

NORTH DAKOTA

BISMARCK - Guitarland, 210 E Main Street, 58501, (701) 255-0212
DICKINSON - Fix It Shop, 316 21st Street E., 58601, (800) 871-0766
FARGO - General Parts & Supply Co., 10 S. 18th St, 58103, (701) 235-4161, (800) 279-9987

OHIO

AKRON - Advanced Appliance Service Company, 73 W. Exchange Street, 44308, (330) 762-8968
CANTON - Appliance Parts Co., 1267 Dueber Avenue, SW, 44706, (330) 453-8077
CINCINNATI - H&S Service, 458 Cincinnati Batavia Pike, 45244, (513) 528-0808
CLEVELAND (MENTOR) - Lake Erie Lawn & Garden, 7833 Munson Rd., 44060, (216) 257-9000
CLEVELAND (PARMA) - Majors Appliance, 5785 Ridge Road, 44129, (216) 884-7200
CLEVELAND (WESTLAKE) - Philips Consumer

Electronics, 24090 Detroit Avenue, 44145, (216) 899-2040, (800) 331-7037
DAYTON - Layer Electric, 603 South Ludlow Street, 45402, (937) 224-9608
DAYTON (NEW CARLISLE) - Ballweg Do-It Center, 3300 South Dayton, Lakeview Rd., 45344, (937) 849-1306
GALION - Allied Electrical Repair, 1404 Harding Way East, 44833, (419) 468-4962, (800) 648-6771
GROVE CITY - City Bike Repair, 3957 Broadway, 43123, (614) 871-9123
LIMA - Crouse Lumber Do-It Center, 333 E. Market Street, 45801, (419) 229-9070, (800) 826-9663
MANSFIELD - Boliantz Hardware, 860 Ashland Road, 44905, (419) 589-5467
PORTSMOUTH - Market St Hardware & Toy Town, 217 Market Street, 45662, (740) 456-5704
TOLEDO - Mr. Appliance of Toledo Inc., 1621 Broadway, 43609, (419) 241-9731, (800) 436-5415
WELLINGTON - Travelite Inc., 750 Industrial Avenue, P.O. Box 98, 44090, (440) 647-3670, (800) 326-0406
YOUNGSTOWN - O'Connor's, 3224 Market Street, 44507, (330) 782-4705
ZANESVILLE - Batteries Unlimited, 2350 Adamsville Road, 43701, (740) 453-3311

OKLAHOMA

OKLAHOMA CITY - Appliance Services by CK, 101 East Madison, 73105, (405) 525-8862
OKLAHOMA CITY - Oklahoma Service Center, 1940 North May Street, 73107, (405) 946-9841
TULSA - H.L. Moss, Inc., 1714 E. 15th Street, 74104, (918) 744-1305, (800) 248-5948

OREGON

PORTLAND - Appliance Repair Central, 2033 N. E. Columbia Blvd, 97211, (503) 285-1828, (800) 588-7339

PENNSYLVANIA

ALTOONA - Frye's Sweeper & Sewing Center, Inc., 1400 Valley View Boulevard, 16602, (814) 943-5001, (800) 640-1308
BUTLER - Battery Warehouse, 469 Cunningham Street, 16001, (724) 287-3191
CRANBERRY - Batteries Plus North, Cranberry Towne Plaza 20808 Route 19, 16066, (724) 742-1690
ERIE - Parke T. Morrow Inc., 627 West 26th Street, 16508, (814) 455-7566
GRAPEVILLE - Jiffy Service, 12 Fourth Street, 15634, (724) 523-5585
GROVE CITY - Battery Warehouse, 620 East Main Street, 16127, (724) 458-1655
HARRISBURG - C. A. Juillard, Inc., 2301 North Seventh Street, 17110, (717) 233-3488, (800) 633-3488
JOHNSTOWN - Cambria Hardware, West Hills Square, 1765 Goucher Street, 15905, (814) 255-4752
KINGSTON - Vac-Way Appliance & Service, 595 Market Street, 18704, (570) 288-4508
LANCASTER - Colonial Electronics Inc., 241 West Roseville Suite #2t, 17601, (717) 560-2222
McDONALD - Small Engine World, 130 East O'Hara Street, 15057 (724) 926-3330
MOSCOW - Vac-Way Appliance & Service, RR #6 Box 6237, 18444, (570) 842-4668
ORANGEVILLE - Hess Do-It Center & Market, Route 487, Box 4 M, 17859, (570) 683-5162
PHILADELPHIA - Appliance Care/Service Corp., 6407 Rising Sun Ave., 19111, (215) 725-3112
PHILADELPHIA (COLLINGDALE) - J.F. Kenney Electric, 308 Mac Dade Blvd, 19023, (610) 534-7373
PITTSBURGH - Batteries Plus North, 4808 McKnight Road, 15237, (412) 366-3600
READING - Electric Repair Co., 502-504 N. 9th Street, 19604, (610) 376-5444, (800) 422-8171 (PA only)
SCRANTON - Vac-Way Appliance and Service, 601 Cedar Avenue, 18505, (570) 343-1121
SHAMOKIN DAM - Willard Battery Outlet, 138 S. Old Trail, 17876, (570) 743-5383
SHIPPENVILLE - Battery Warehouse, 11041 Rt. 322 Riverhill, 16254, (814) 227-2123
TROY - Hoover Hardware, 9 Canton, 16947, (800) 251-2156, (570) 297-3445
WILKES-BARRE - Walter Hardware DO-IT Center, 57 N. Welles Street, 18702, (570) 823-1406

PUERTO RICO

MAYAGUEZ - Cardona Appliance Service, 8 San Vicente Street, 00680, (787) 832-8366
MAYAGUEZ - AAA Melendez Rental, Calle Post 319 Sur, 00680, (787) 832-5225
PONCE - Ferreteria Vivian, Centro Comercial, Los Caobos #7, 00731, (787) 840-0677
PUERTO NUEVO - Buckeye Service, 1013 Jesus T. Pinero Avenue, 00920, (787) 782-6175

SOUTH CAROLINA

AIKEN - Dunagan's Sewing & Vacuum, 2160 University Parkway, 29801, (803) 648-4837
BELTON - American Pro Office Equipment, 309 Forest Lane, 29627, (864) 338-9041
CHARLESTON HEIGHTS - Dorchester Electric Service, 3575 Dorchester Avenue, 29405, (803) 747-5221
COLUMBIA - Authorized Appliance Servicenter, 1811 Taylor Street, 29202, (803) 254-8414
EASLEY - Trails End Bicycles, 110 Pendleton Street, 29640, (864) 306-1684
FORT MILL - Service Engines & Supply, Inc., 3023 Highway 21, 29715, (803) 548-1778, (800) 845-1191
GREENWOOD - Bikes & Boards & Mopeds, 203A Montague Avenue, 29646, (864) 229-2453
SENECA - Seneca Micronics, 110 East North First, 29678, (864) 882-6593
SPARTANBURG - Jones Electronic Services, 9104 Greenville Hwy, 29301, (864) 576-0482, (800) 677-0482

SOUTH DAKOTA

WINNER - Nelson's Electronics Inc., 422 West 2nd Street P.O. Box 369, 57580, (605) 842-1611, (888) 842-1699

TENNESSEE

CHATTANOOGA - Consumer Service Company, 2607 E 47th Street, 37407, (423) 867-8629
DANDRIDGE - Save More Sales, 1291 W Hwy. 25-70, 37725, (865) 397-1255
KNOXVILLE - Appliance & Electric Service Company, 3613 Sutherland Avenue, 37919, (865) 588-5395, (800) 585-5395
KNOXVILLE - Authorized Appliance Service Center, 1206 North Central Street, 37917, (865) 524-3376
MEMPHIS - Camp Electric Co., 647 Madison Avenue, 38103, (901) 527-7543, (800) 238-7345
NASHVILLE - Webb's Appliance Service Center, Inc., 1519 Church Street, 37203, (615) 329-4079, (800) 899-4079
PINEY FLATS - Appalachian Small Engines, 6192 Hwy 11E, 37686, (423) 391-0185, (800) 219-8810

TEXAS

AMARILLO - Reid's Appliance Service, Inc., 906 Georgia, 79102, (806) 373-8812
CORPUS CHRISTI - Brand Appliance & Microwave, 2751 South Staples, 78404, (361) 854-1851
DALLAS - All Type Sales and Service Co., Inc., 2835 Irving Blvd., 75207, (214) 638-1170, (800) 717-1170
DALLAS - Pearsol Appliance Co., 3127 Main Street, 75226, (214) 939-0930
FT. WORTH - Ft. Worth Shaver and Appliance Center, 1900 Montgomery Street, 76107, (817) 335-9970, (800) 816-2126
HOUSTON - Brand Service Center, 5727 Richmond Avenue, 77057, (713) 782-8910
KERRVILLE - Lopez Electric, 425 McFarland Drive, 78028, (830) 896-1171, (888) 520-6415
KILLEEN - Master Tech Repairs, 501 West Elms Road Suite #10, 76542, (254) 618-5480
LONGVIEW - Foster's, 3315 Gilmer Road, 75604, (903) 559-3939
LUBBOCK - Minter's, 4409 50th Street, 79414, (806) 799-3170
LUFKIN - STS Audio and Video, 1505 South First Street, 75901, (936) 639-4529
MC ALLEN - All-In-One Repair Shop, 2313 Lark Avenue, 78504, (210) 682-8858
MIDLAND - Midland Tool Specialty, 918 South Main, 79701, (915) 682-4647, (800) 499-0755
ROMA - True Value Hardware, 1004 E. Highway 83, (210) 849-1322

Authorized Service Centers

SAN ANTONIO - Texas Shaver & Appliances, 8121 Callaghan Road, 78230, (210) 344-8577
TEMPLE - Master Tech Repairs, 2819 West Avenue North, 76504, (817) 773-8991
WICHITA FALLS - Allens Appliance Service, 2403 10th Street, 76309, (940) 766-2635

UTAH

OREM - The Mending Shed, 1735 South State Street, 84058, (801) 225-8012, (800) 339-9297
SALT LAKE CITY - Appliance Service Center, Inc., 1475 South Main, 84115, (801) 467-6361, (800) 377-8020
WILLARD - Peak Electric Co Inc, 780 N 200 W, 84340, (435) 723-7104

VIRGINIA

ALEXANDRIA - D & S Repair Service, 20 South Dove Street., 22314 (703) 683-0009
LOUISA - Lakeside Electric Const., 4344 Davis Highway Suite 2, 23093, (540) 967-3000
RICHMOND - Wells Inc., 3502 Jefferson Davis Highway, 23234, (804) 233-6726
ROANOKE - Commonwealth Shaver & Appliance Service, 5524 Williamson Road, NW, 24012, (540) 366-6038
VIRGINIA BEACH - Commonwealth Electric Shaver, 549 Newton Road #108, 23462, (757) 490-0500
WINCHESTER - Battery Mart of Winchester, Inc., 1 Battery Dr., 22601, (703) 655-0065

WASHINGTON

ARLINGTON - Cordz Limited, 6516 211th Avenue, 98223, (360) 435-2471
KENNEWICK - At Home Electronic Services Inc., 313 East First Avenue, 99336, (509) 586-3800
SEATTLE - Action Small Appliance, 2125 2nd Avenue, 98121, (206) 448-2020
SEATTLE (BELLEVUE) - Action Small Appliance Service, 1500 145th Place, SE, 98007, (206) 643-9806
SPOKANE - Aalwaco Appliance, N 3007 Argonne Road, 99212, (509) 487-1089

WEST VIRGINIA

BECKLEY - Jerry's Detectors, Vacuum & Appl. Svc., 411 Second Street. 25801, (304) 253-3521
CHARLESTON - Sneed's Vacuum & Sewing Center, 2614 7th Avenue, 25312, (304) 744-3670, (800) 245-8048 (WV only)
HUNTINGTON - Mike's Appliance and Service, 212 20th Street, 25703, (304) 522-0737
MARTINSBURG - Battery Mart, 1494 Winchester Avenue, 25401, (304) 267-7033
VIENNA - T & S Lawn - Landscape & Power Equipment, 1100 10th Street, 26105, (304) 295-7633 (800) 559-7633
WHEELING - Fast Service Center, 1058 Main Street, 26003, (304) 232-5561 (800) 874-4090

WISCONSIN

ELK MOUND - Epp Electronics, E9485-A County Road EE, 54739, (715) 879-4634
GREENBAY - Kastle Carts, Inc., 2301 N. Irwin Ave., 54313, (414) 465-6121
LACROSSE - Paul's Shaver Service, 1224 Caledonia Street, 54603, (608) 782-6291
MILWAUKEE - Abby Electronics, 4295 S. 20th Street, 53221, (414) 281-6602
MILWAUKEE - Brand Appliance Repair, Inc., 6601 W Oklahoma Avenue, 53219, (414) 541-4340
MONONA - Kiefers Shaver & Appliance, 4511 Monona Drive, 53716, (608) 221-3322

IMPORTANT!

DO NOT use the mini-bike for the first time until you have charged the battery for 18 hours.

Remember to...

- ✓ Charge the battery immediately after each use.
- ✓ Charge the battery once a month during storage, even if the mini-bike has not been used.

Failure to follow these instructions will permanently damage your battery and void your warranty. Please refer to the Battery Care Section in this manual for more information.

DO NOT Return your Mini-Bike to the Store !



If you are missing parts or need assistance, please call us toll-free:

Power Wheels® Consumer Relations

1-800-348-0751

8 AM - 6 PM EST, Monday through Friday.

Or contact your local **independently owned and operated** Power Wheels® Authorized Service Center.

For the location nearest you, refer to the Authorized Service Center list in this manual.



www.powerwheels.com

©2003 Mattel, Inc. All Rights Reserved.

Fisher-Price, Inc., a subsidiary of Mattel, Inc., East Aurora, New York 14052 U.S.A.

Free Manuals Download Website

<http://myh66.com>

<http://usermanuals.us>

<http://www.somanuals.com>

<http://www.4manuals.cc>

<http://www.manual-lib.com>

<http://www.404manual.com>

<http://www.luxmanual.com>

<http://aubethermostatmanual.com>

Golf course search by state

<http://golfingnear.com>

Email search by domain

<http://emailbydomain.com>

Auto manuals search

<http://auto.somanuals.com>

TV manuals search

<http://tv.somanuals.com>