

**Fisher-Price®**

**K3795  
M8743**



**WARNING**

PLEASE KEEP THESE  
INSTRUCTIONS FOR  
FUTURE REFERENCE.

[www.fisher-price.com.au](http://www.fisher-price.com.au)



## WARNING

### **Prevent serious injury or death from falls or sliding out:**

- Always secure child with the restraint belts until child is able to get in and out of the product without help (about 2<sup>1</sup>/<sub>2</sub> years old). The tray is not designed to hold child in the product.
- Never leave child unattended.
- Always secure the product on a chair using the bottom and back attachment straps. Never use the product on a stool or bench that does not have a seat back.
- Only use upright position when child is capable of sitting upright unassisted.

### **Prevent serious injury or death:**

- Do not use in motor vehicles.

## Consumer Information

**IMPORTANT!** Before assembly and each use, inspect this product for damaged hardware, loose joints, missing parts or sharp edges. DO NOT use if any parts are missing or broken. Contact Mattel for replacement parts and instructions if needed. Never substitute parts.

- Please read these instructions before assembly and use of this product.
- Adult assembly and setup is required. No tools needed for assembly or setup.
- Product features and decorations may vary from photos.
- Australia: Mattel Australia Pty. Ltd., 658 Church Street, Locked Bag #870, Richmond, Victoria 3121 Australia. Consumer Advisory Service 1300 135 312.
- New Zealand: 16-18 William Pickering Drive, Albany 1331, Auckland.

## Care

- The pad, seat, seat back and straps may be wiped clean using a mild cleaning solution and damp cloth. Do not use bleach. Do not use harsh or abrasive cleansers. Rinse clean with water to remove residue.
- The tray is top rack dishwasher safe (or use the bottom rack - without using the drying cycle).

### To remove the pad:

- Push to remove the shoulder straps from the slots on the waist restraint buckle.
- Lift the top of the pad off of the seat back.
- Fit the shoulder belts back through the slots in the pad.
- Unfasten the pad hooks from the front edge of the seat.
- Unbuckle the waist belts from the crotch belt.
- Fit the crotch belt down through the slot in the pad.
- Fit the waist belts back through the slots in the pad.
- Remove the pad from the seat.
- To replace the pad: refer to Assembly steps 2 - 6.

**IMPORTANT!** Never use this product without the restraint system. Replace the crotch, waist and shoulder belts for high chair use; replace the crotch and waist belts for booster seat use.

## Parts

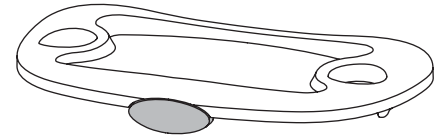

Tray

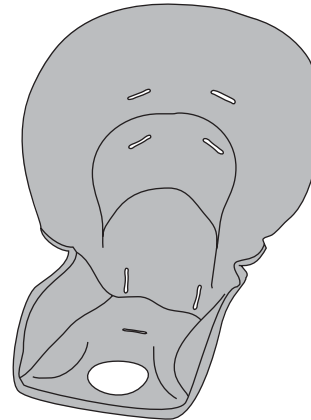

Pad

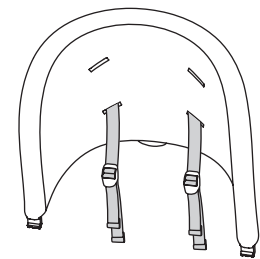

Seat Back with Restraint System

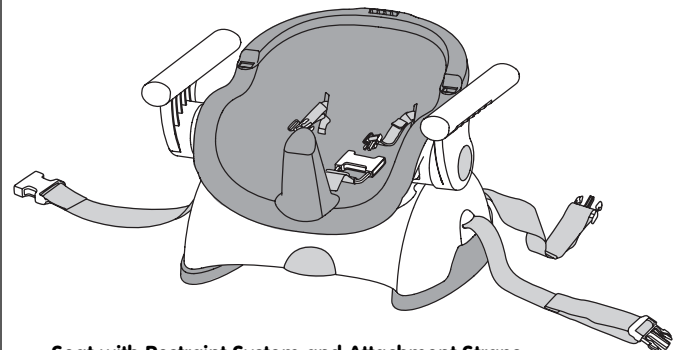

Seat with Restraint System and Attachment Straps

# Assembly

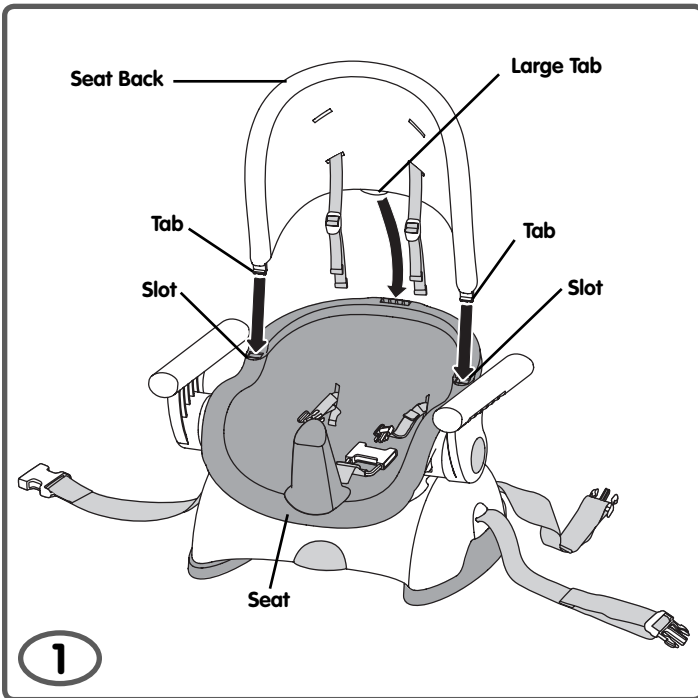

- Fit the seat back tabs into the slots in the top of the seat.
- Push the top of the seat back so that the large tab “snaps” into place in the seat.

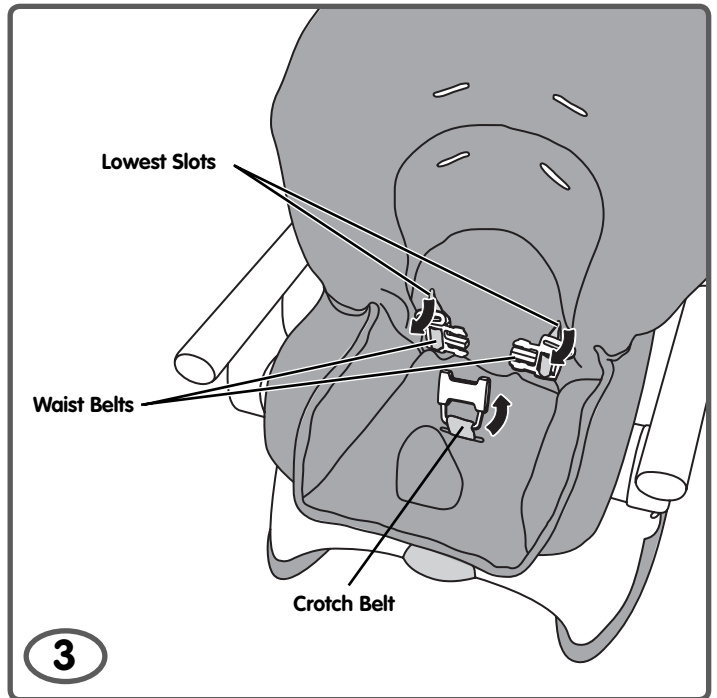

- Fit the waist belts on the seat through the lowest slots in the pad. Make sure the waist belts are not twisted.
- Fit the crotch belt on the seat through the large slot in the pad. Make sure the crotch belt is not twisted.

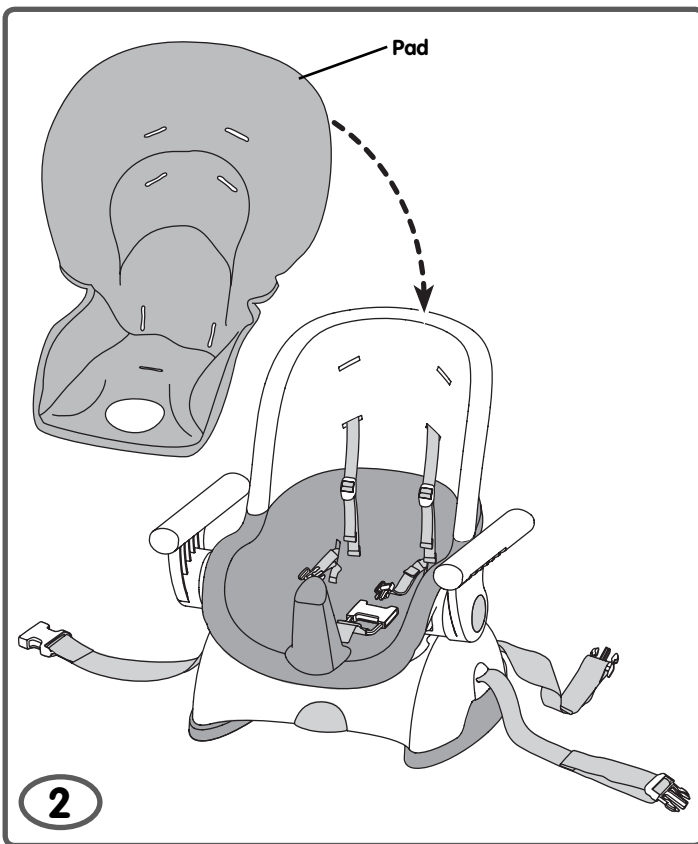

- Fit the pad onto the seat.

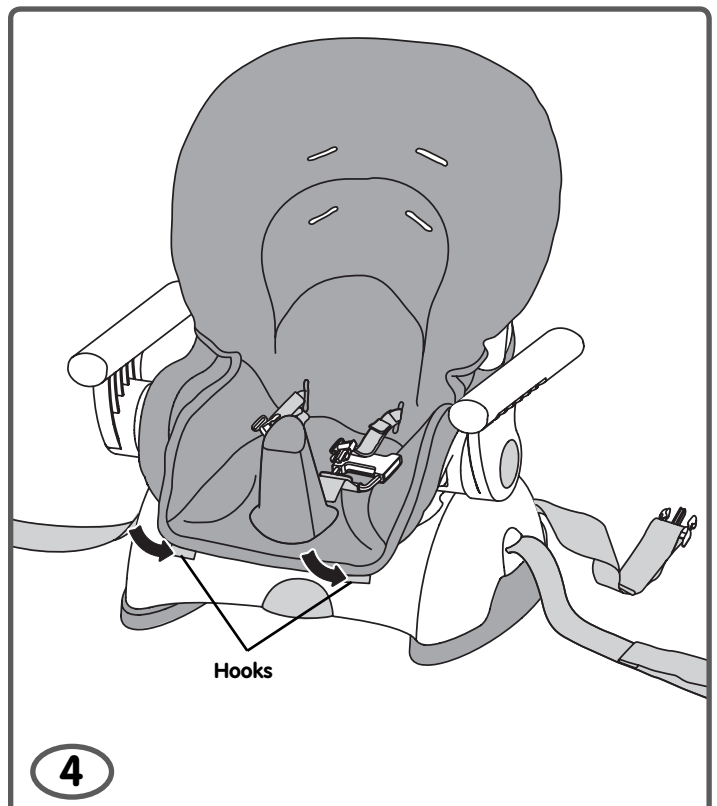

- Fasten the hooks on bottom of the pad to the front edge of the seat.

## Assembly

## Adjusting the Seat Height

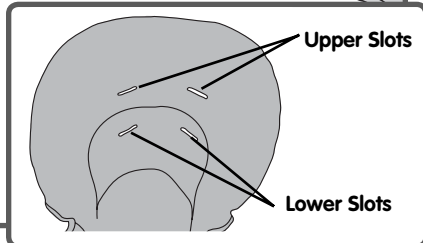
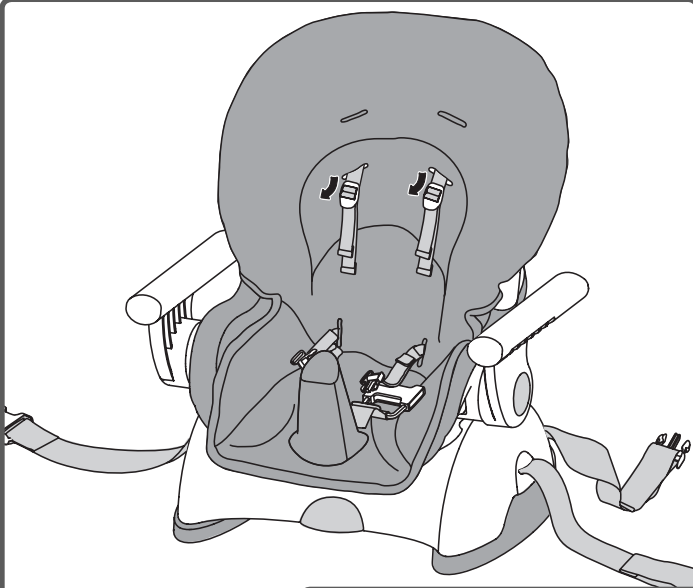

5

- Insert the shoulder belts through the slots in the pad.
  - Use the lower shoulder belt slots for a smaller baby.
  - Use the upper shoulder belt slots for a larger baby.
- Make sure the shoulder belts are not twisted.

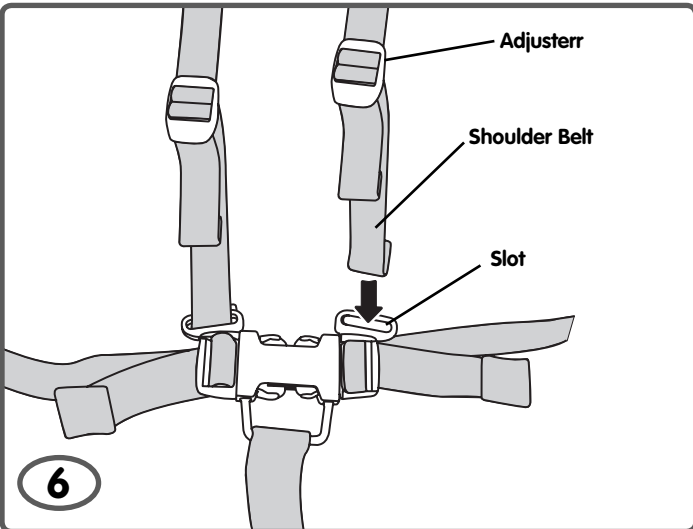

6

- Locate the longer portion of the shoulder belt, underneath the adjuster.
- Fit the end of this longer portion through the slot in the top of the waist belt.

**Hint:** If the end does not fit at all through the slot, you are probably inserting the wrong end. Make sure you insert the longer portion of the belt through the slot.

- Repeat this procedure to attach the other shoulder belt to the other waist belt.

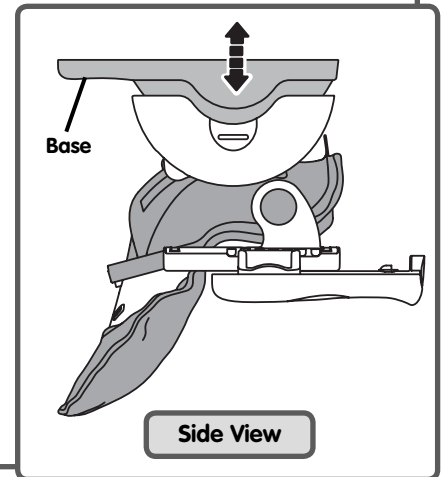
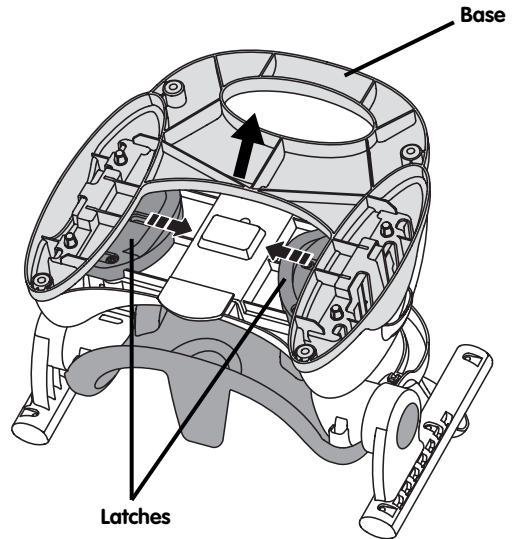

- While squeezing the latches together with one hand, lift or lower the base.

**Hint:** This will require some force. You may want to pull one latch and lift or lower one side of the base. Then repeat this procedure to lift or lower the other side of the base.

- Release the latches to lock the base in place
- While adjusting seat height, you may accidentally pull the base completely off of the seat bottom. If this should happen, simply squeeze the latches together and fit the base back onto the seat bottom.

## Attaching to a Chair

### WARNING

**Prevent serious injury or death from falls or sliding out:** Always secure the product on a chair using bottom and back attachment straps. Never use the product on a stool or bench that does not have a seat back.

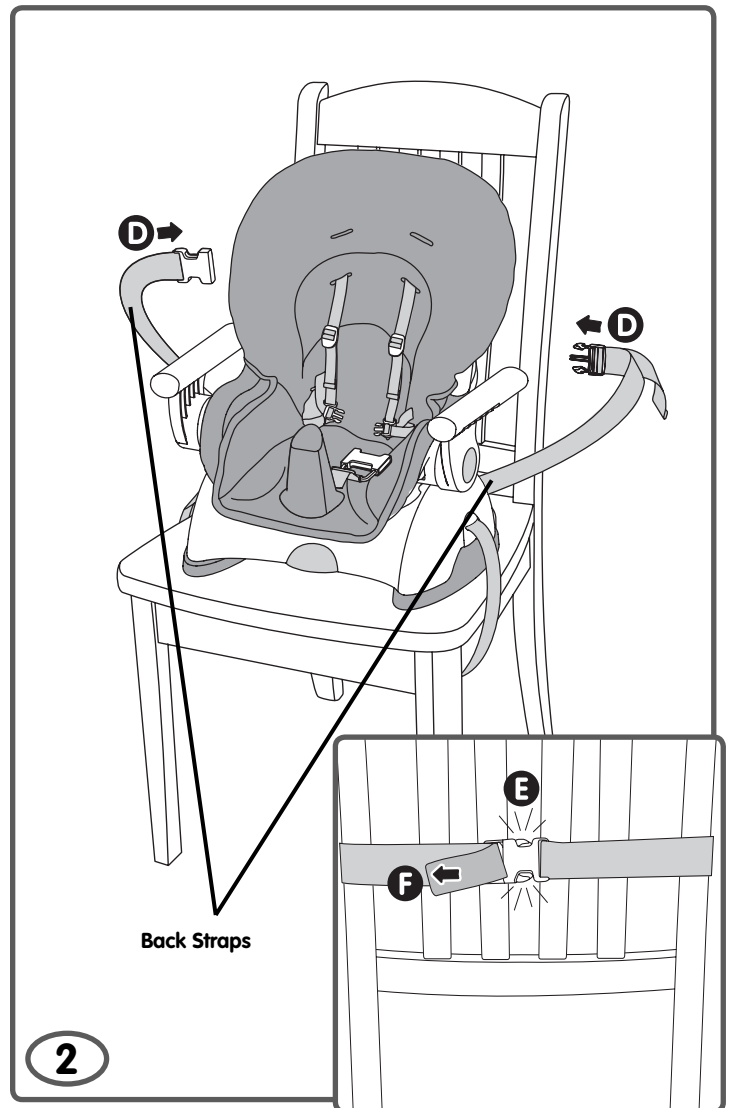
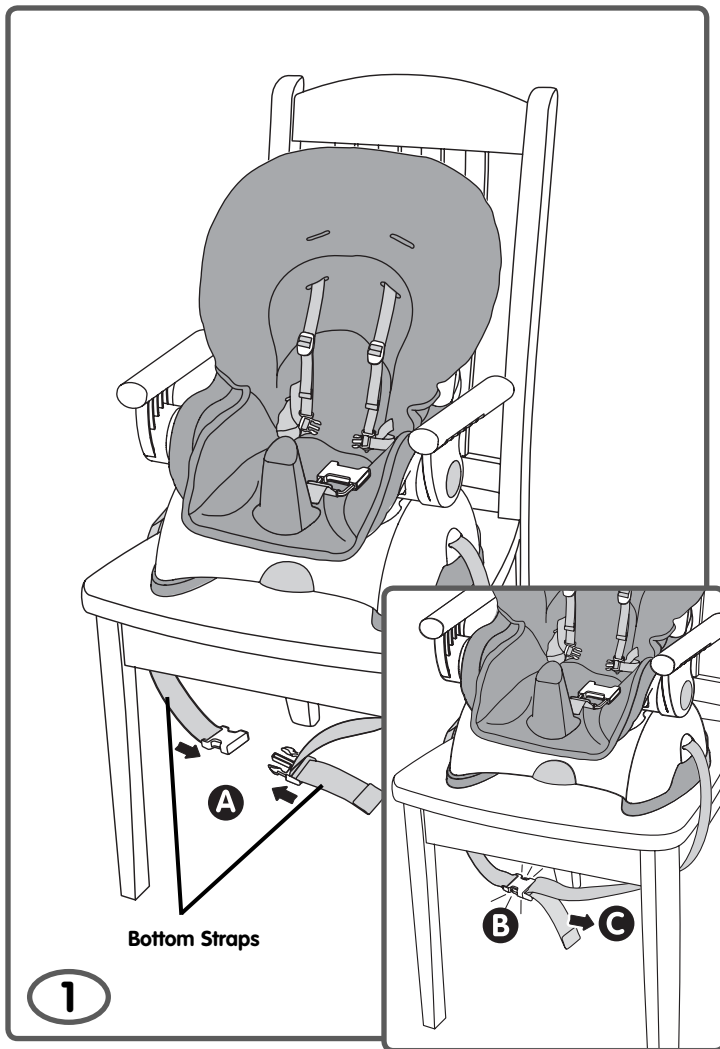

- Wrap the back straps around the back of the chair **D**. Buckle the straps **E**. Make sure you hear a "click." Pull the free end of the strap to tighten on the chair **F**.

**IMPORTANT!** Place the product on a chair on a level, stable surface, away from electrical flexes. Be sure to keep electrical flexes out of child's reach.

- Place the seat on a chair.
- Wrap the bottom straps around the bottom of the chair **A**. Buckle the straps **B**. Make sure you hear a "click". Pull the free end of the strap to tighten on the chair **C**.

## Adjust Seat Recline

### WARNING

**Prevent serious injury or death from falls or sliding out:** Only use upright position when child is capable of sitting upright unassisted.

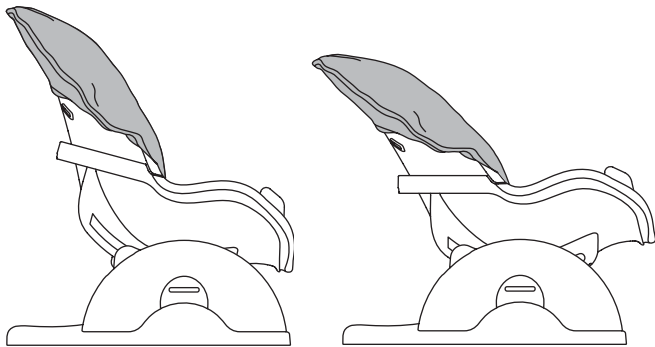

**Upright**

**Semi-Recline**

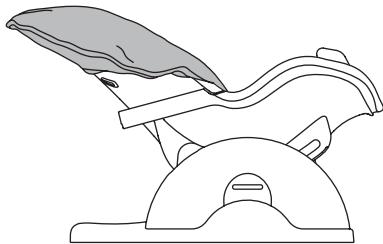

**Recline**

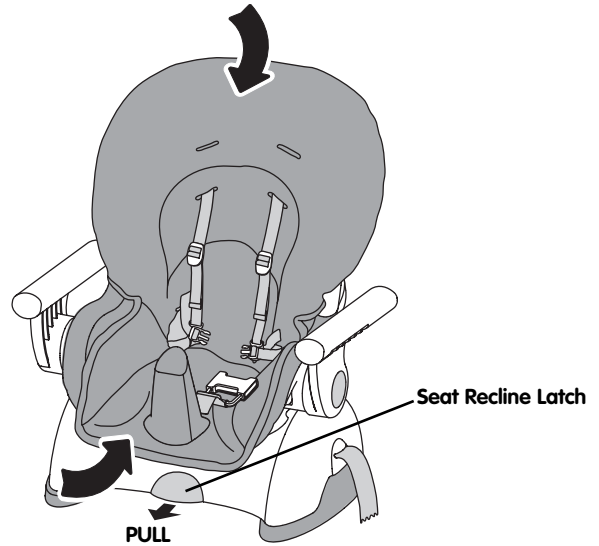

- While pulling the seat recline latch, push the top of the seat back to lower in the desired position. Or, while pulling the seat recline latch, push the bottom of the seat to lift in the desired position.
- Release the seat recline latch.
- Push on the seat back to be sure the seat is secure.

**Hint:** You may not be able to fully recline this product on some kitchen chairs.



## Adjust Armrests

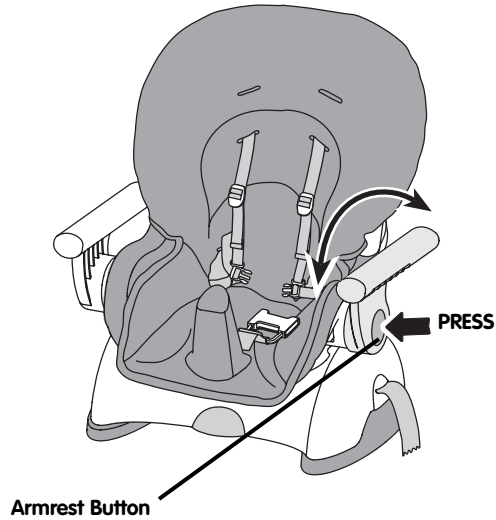

- While pressing the armrest button, rotate the armrest forward or backward to the desired position.
- Repeat this procedure to adjust the other armrest.

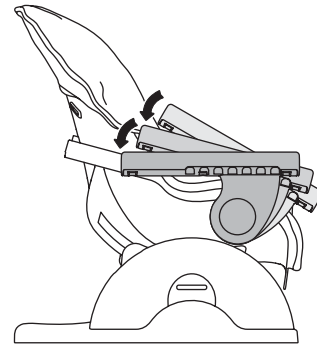

**Upright Seating**

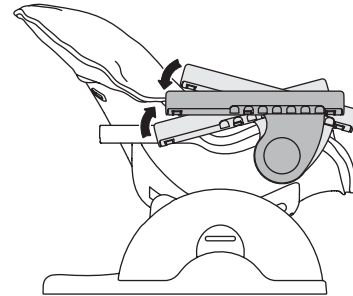

**Semi-Recline Seating**

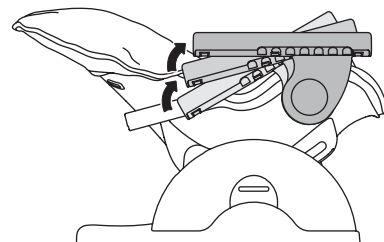

**Recline Seating**



## Secure Child

### WARNING

#### Prevent serious injury or death from falls or sliding out:

- Always secure child with the restraint belts until child is able to get in and out of the product without help (about 2½ years old). The tray is not designed to hold child in product.
- Never leave child unattended.

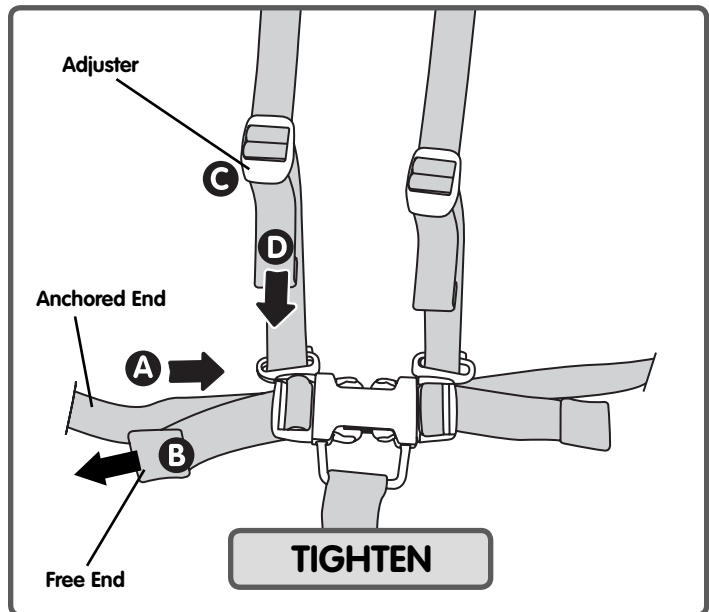

#### To tighten the waist belts:

- Feed the anchored end of the waist belt up through the buckle to form a loop **A**. Pull the free end of the waist belt **B**.
- To tighten the shoulder belts: Hold the adjuster **C** and pull the front shoulder strap down **D**.

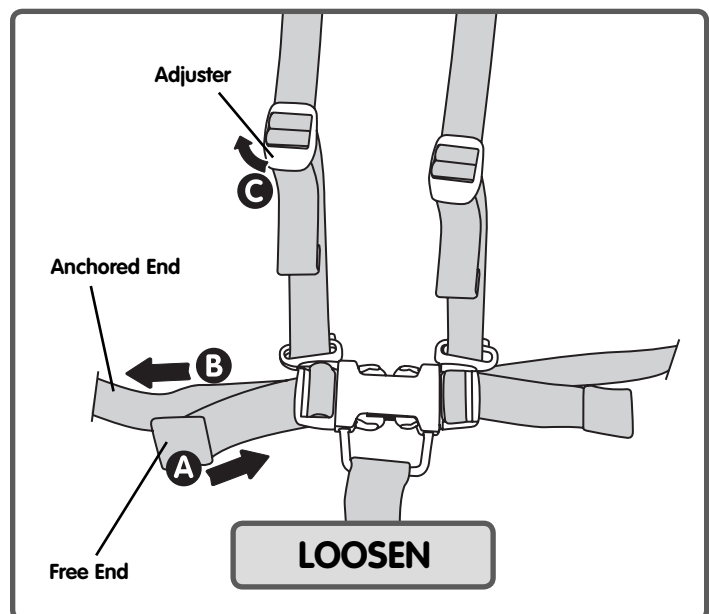

#### To loosen the waist belts:

- Feed the free end of the waist belt up through the buckle to form a loop **A**. Enlarge the loop by pulling on the end of the loop toward the buckle. Pull the anchored end of the waist belt to shorten the free end of the waist belt **B**.
- To loosen the shoulder belts: Lift the adjuster **C**.

Note: After adjusting the restraint system to fit your child, make sure you pull on it to be sure it is securely fastened.

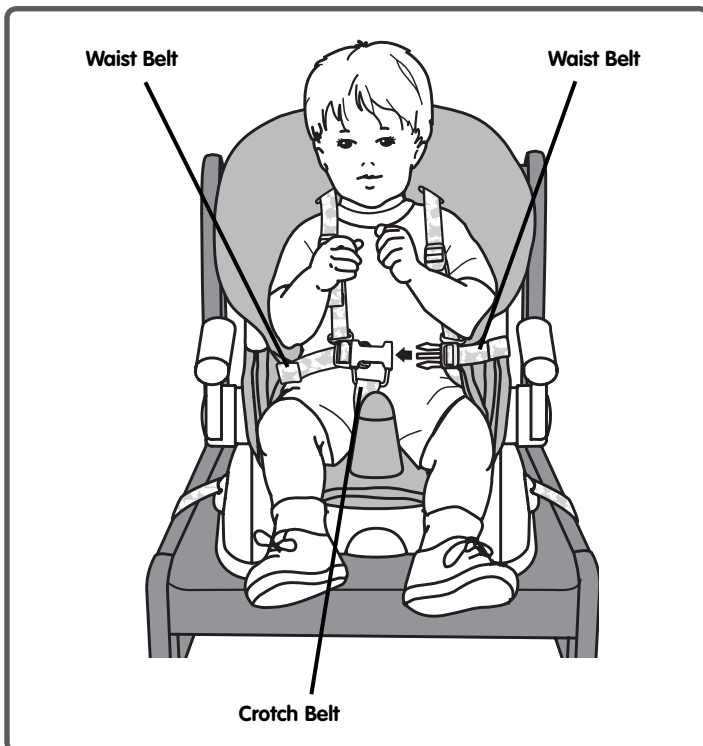

- Place your child in the seat. Position the crotch belt between your child's legs.
- Buckle the restraint belts to the crotch belt. Make sure you hear a "click" on both sides.
- Check to be sure the restraint system is securely attached by pulling it away from your child. The restraint system should remain attached.

## Tray Use

*Hint: Before first time use, wash the tray thoroughly with soap and water. The tray is top rack dishwasher safe (or use the bottom rack - without using the heated drying cycle).*

### WARNING

**Prevent serious injury or death from falls or sliding out:** Always secure child with the belts until child is able to get in and out of the booster seat without help (about 2½ years old). The tray is not designed to hold child in the booster seat.

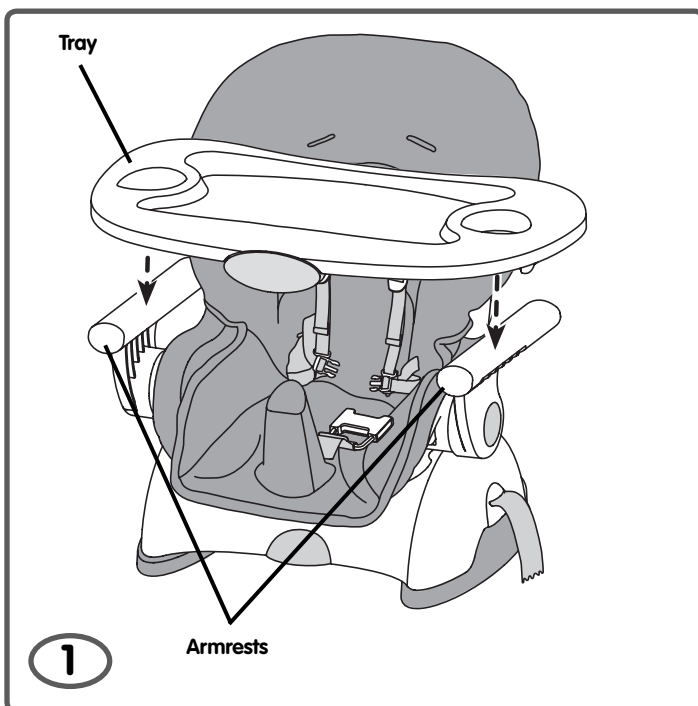

- Fit the tray onto the armrests. Push down until the tray “snaps” into place.

Note: The tray is not microwave safe.

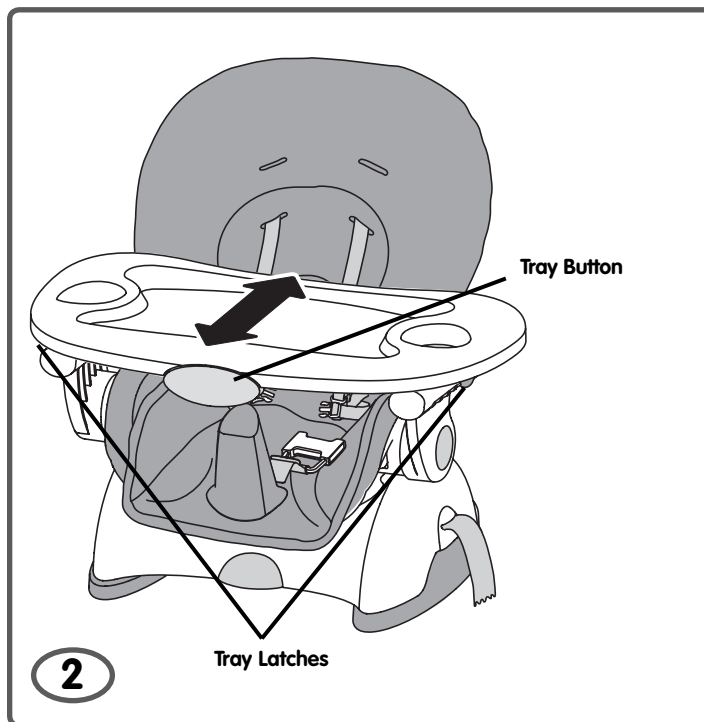

- You can adjust the tray forward or backward.
  - While pressing the button on the front of the tray, push or pull the tray forward or backward.
  - While squeezing both latches underneath the tray, push or pull the tray forward or backward.

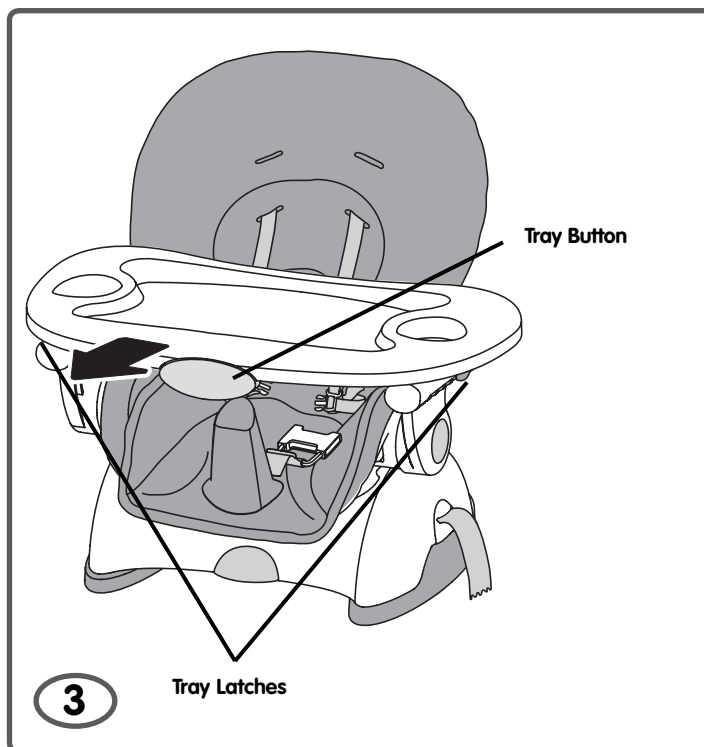

- While squeezing both latches underneath the tray, pull to remove.

## Convert to Booster Seat

This high chair easily converts to a booster high chair for toddlers.

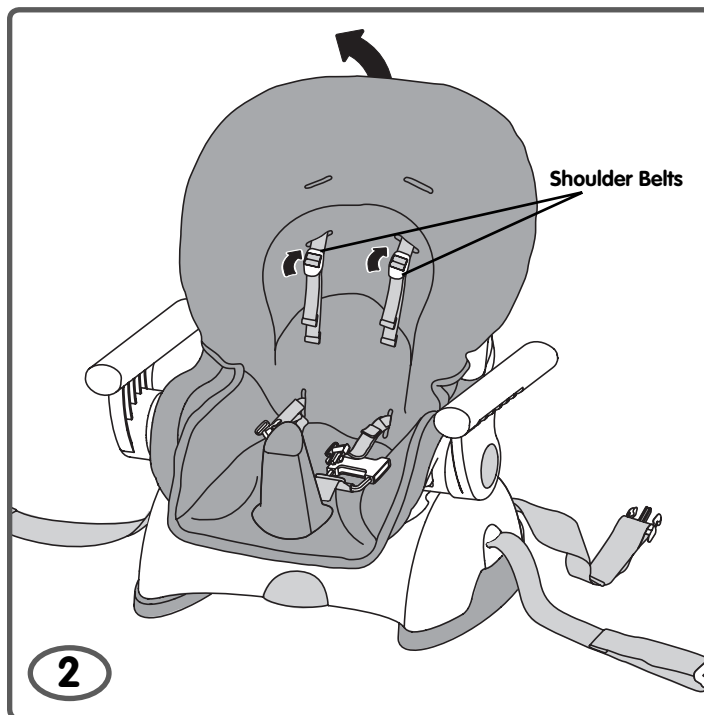

- Fit the shoulder belts back through the slots in the pad.
- Lift the top of the pad off of the seat back.

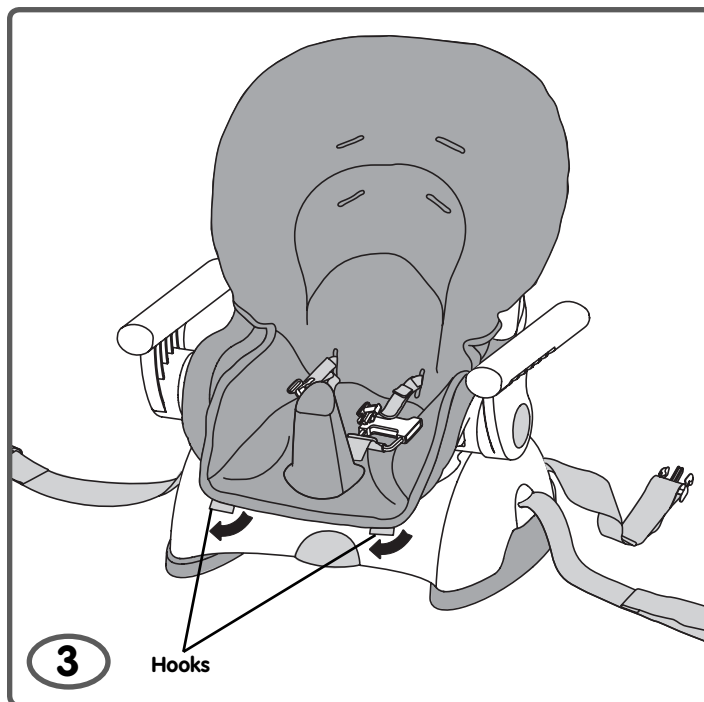

- Unfasten the pad hooks from the front edge of the seat.
- Unbuckle the waist belts from the crotch belt.

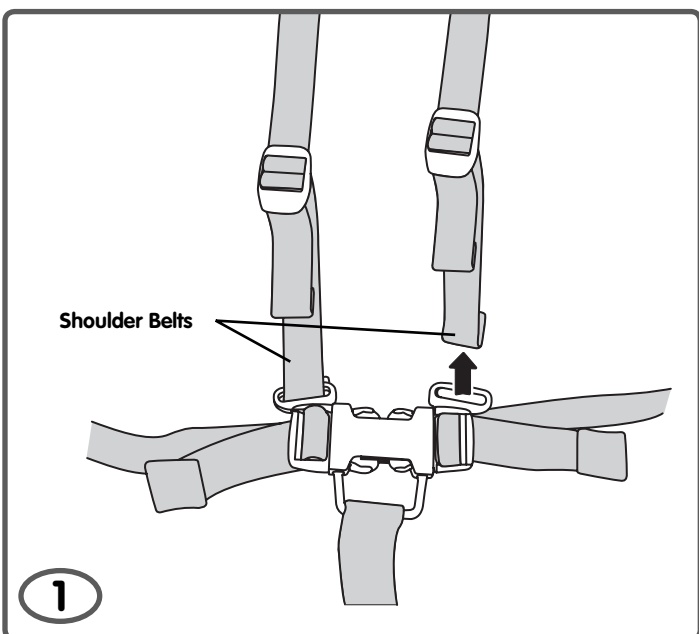

- Push to remove the shoulder belts from the waist restraint buckle slots.

## Convert to Booster Seat

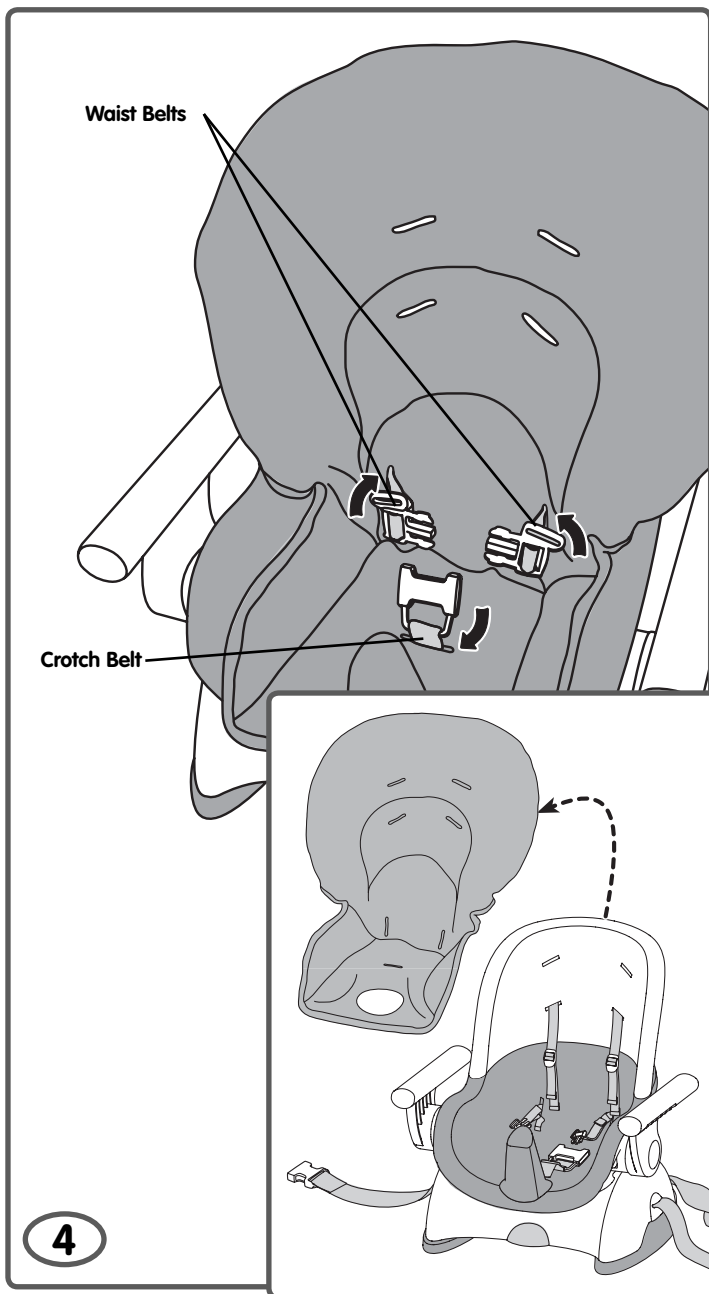

- Fit the crotch belt down through the slot in the pad.
- Fit the waist belts back through the slots in the pad.
- Remove the pad from the seat.

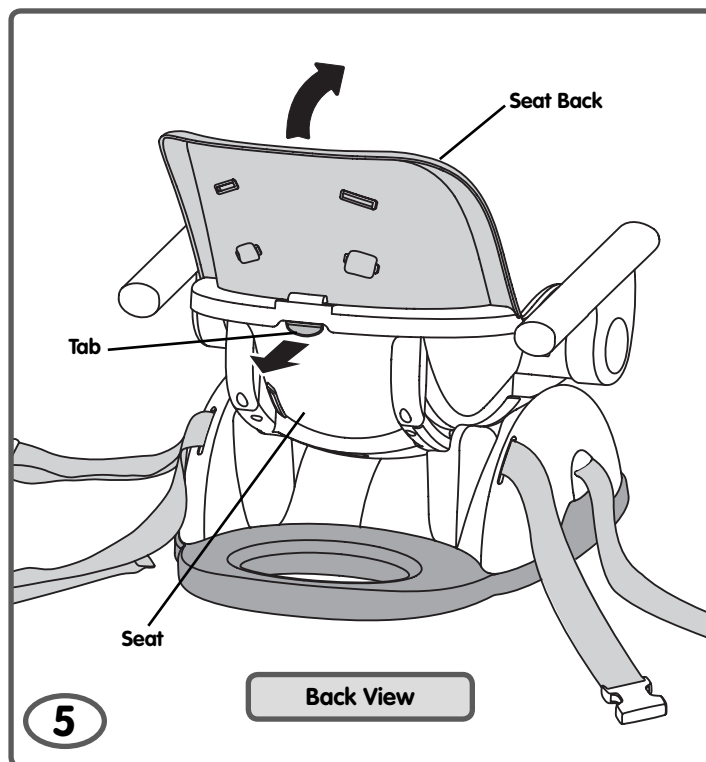

- Pull the tab on the seat back. Lift to remove the seat back from the seat.
- Store the seat back, pad and shoulder belts in a safe place for future use.

## Free Manuals Download Website

<http://myh66.com>

<http://usermanuals.us>

<http://www.somanuals.com>

<http://www.4manuals.cc>

<http://www.manual-lib.com>

<http://www.404manual.com>

<http://www.luxmanual.com>

<http://aubethermostatmanual.com>

Golf course search by state

<http://golfingnear.com>

Email search by domain

<http://emailbydomain.com>

Auto manuals search

<http://auto.somanuals.com>

TV manuals search

<http://tv.somanuals.com>