

Fisher-Price®

T3857

SMARTCYCLE RACER®

PHYSICAL LEARNING ARCADE SYSTEM



Please keep this owner's manual for future reference, as it contains important information.

Requires four "D" (LR20) **alkaline** batteries (not included) for operation.

Age: 3-6 years

This product is intended for indoor use only.

Use **ONLY alkaline** batteries for longest battery life.

www.fisher-price.com

Download from Www.Somanuals.com. All Manuals Search And Download.

GET UP. GET SMART. GET GOING!

It's a stationary bike, a learning center, and an arcade game system – all rolled into one! Smart Cycle® plugs right into your TV, ready to take kids on learning adventures like no other. As they pedal, favorite character friends guide them through learning discoveries, games, and even exciting races.

Drive

Pedal, steer and learn at your own pace – visit Math Mountain, Shape Lake, Number Fields, Letter Creek and other stops along the way.

Learn

Stop and rest, but don't stop learning! Use the joystick to reinforce important learning skills with plenty of games and activities – with different levels for growing kids.

Race

Put the pedal to the metal as you race with cars on-screen, against the clock, or with another player!

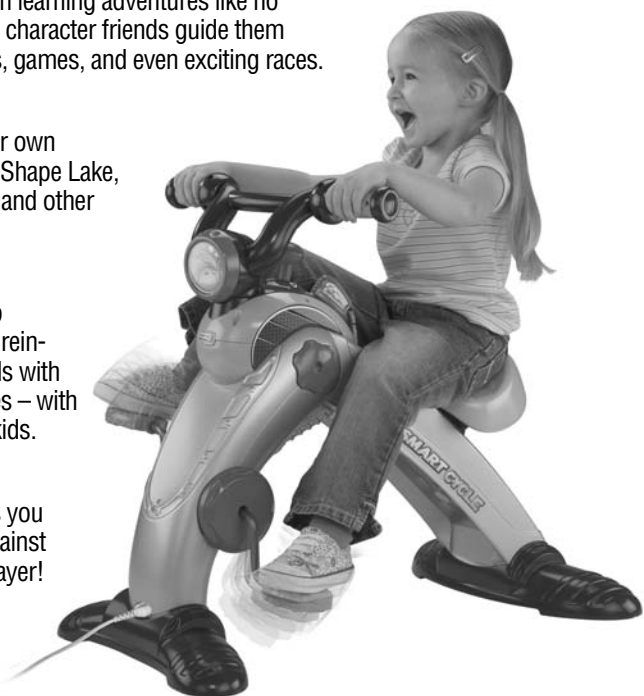

Safety Tips

- Always sit on the seat.
- Always wear shoes.
- Only one (1) rider at a time.

PARTS



**Frame
with Console**



Seat Post



Handlebar



**Front Base
(Small)**



Seat



Pedal Assembly



**Back Base
(Large)**



**Learning Adventure
Game Cartridge
with Key Ring**



Plug-and-Play Cord



Frame Cover (with Bolt)

Adult assembly is required. Tool needed for assembly:
Phillips screwdriver (not included).



#8 x 1,25" Screw - 14

Shown Actual Size

Note: Tighten and loosen all screws with a Phillips screwdriver. Do not over-tighten screws.

ASSEMBLY

CAUTION

This product contains small parts in its unassembled state. Adult assembly is required.

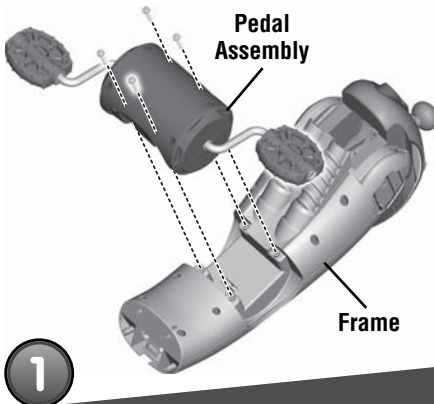

- Fit the pedal assembly into the groove in the underside of the frame, as shown.
- Hint:** *The pedal assembly is designed to only fit one way. If it does not seem to fit, turn it around and try again.*
- Insert four screws into the pedal assembly. Fully tighten the screws.

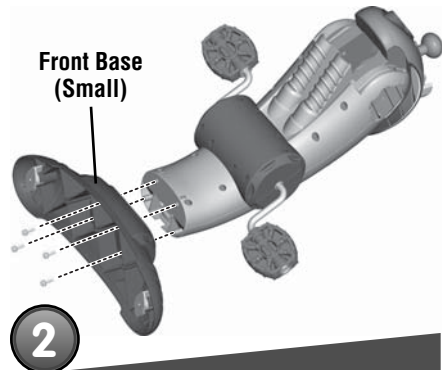

- Fit the front base (small) onto the bottom of the frame, as shown.
- Hint:** *The front base is designed to fit onto the frame one way. If it does not seem to fit, turn it around and try again.*
- Insert four screws into the front base and tighten.

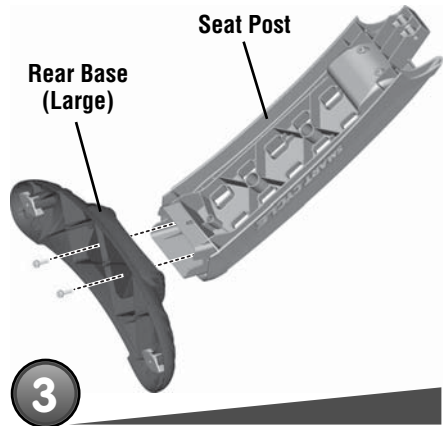

- Fit the rear base (large) onto the end of the seat post, as shown.
- Hint:** *The rear base is designed to fit onto the seat post one way. If it does not seem to fit, turn it around and try again.*
- Insert two screws into the rear base and tighten.

ASSEMBLY

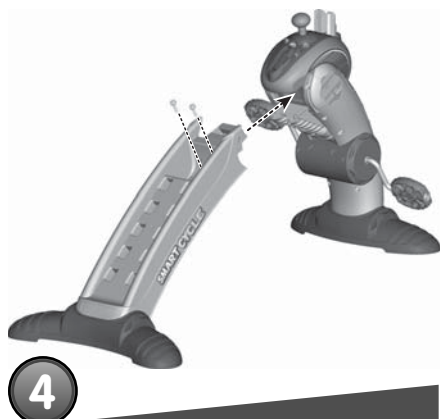

4

- Turn both the frame and seat post assemblies upright.
- Fit the seat post assembly onto the frame assembly.
- Insert two screws into the seat post and tighten.

Hint: You may want to insert the frame cover with bolt into the frame assembly before inserting and tightening screws in the post.

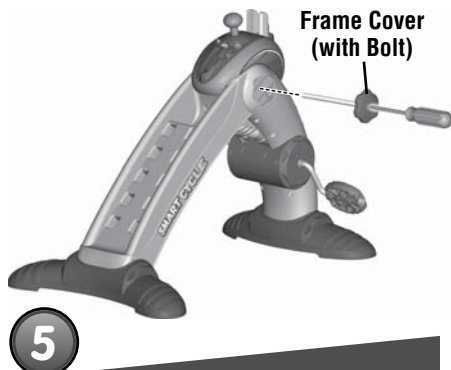

5

- Insert the frame cover with bolt into the hole on the side of the frame assembly.
- Fully tighten the bolt.



6

- Fit the handlebar onto the frame, as shown.

Hint: The handlebar will only fit one way onto the console. If it does not seem to fit, turn it around and try again!

- Insert two screws into the handlebar and tighten.
- Pull up on the handlebar to be sure it is secure.

ASSEMBLY

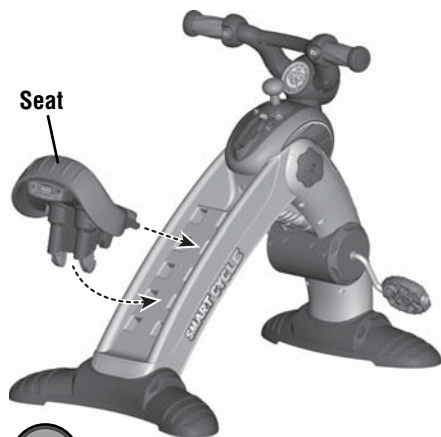

7

- At an angle, fit the upper tabs on the front of the seat into the slots on the seat post.
- Lower the seat to fit the bottom tabs on the seat into the slots on the seat post. You should hear a **"click"**.
- Push down on the seat to be sure it is secure.

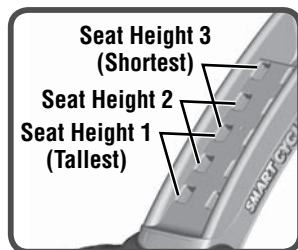

8

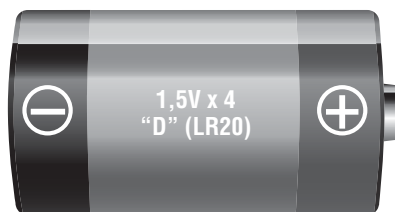
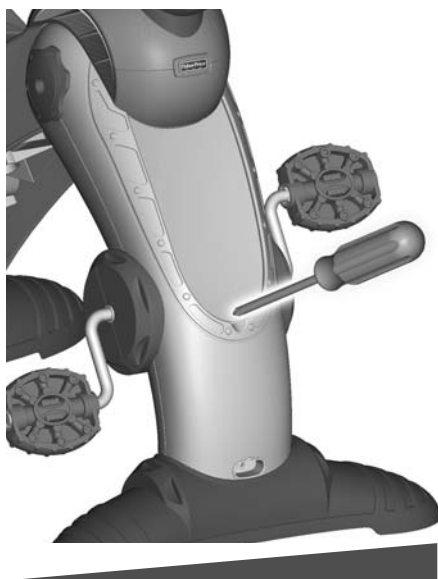

- For your child's comfort, the seat can be adjusted to any of three seat heights (upper slots for shorter children and lower slots for taller children).
- To remove the seat, press the tabs underneath and lift.
- Replace the seat at the desired height and push down on the seat to be sure it is secure in the slots in the seat post.

BATTERY INSTALLATION



Battery Safety Information

In exceptional circumstances, batteries may leak fluids that can cause a chemical burn injury or ruin your toy. To avoid battery leakage:

- Do not mix old and new batteries or batteries of different types: alkaline, standard (carbon-zinc) or rechargeable (nickel-cadmium).
 - Insert batteries as indicated inside the battery compartment.
 - Remove batteries during long periods of non-use. Always remove exhausted batteries from the toy. Dispose of batteries safely. Do not dispose of this product in a fire. The batteries inside may explode or leak.
 - Never short-circuit the battery terminals.
 - Use only batteries of the same or equivalent type, as recommended.
 - Do not charge non-rechargeable batteries.
 - Remove rechargeable batteries from the toy before charging.
 - If removable, rechargeable batteries are used, they are only to be charged under adult supervision.
- Locate the battery compartment on front of the frame. Loosen the screw in the battery compartment door and remove the door.
 - Insert four "D" (LR20) **alkaline** batteries.
- Hint:** We recommend using **alkaline** batteries for longer battery life and proper function.
- Replace the battery compartment door and tighten the screw.
 - If this product begins to operate erratically, you may need to reset the electronics. Slide the power switch off and then back on.
 - When function is erratic or stops, or you see a low battery symbol on your TV screen , it's time for an adult to change the batteries!
-  • Protect the environment by not disposing of this product with household waste (2002/96/EC). Check your local authority for recycling advice and facilities (Europe only).

CONNECTING SMART CYCLE® TO YOUR TV

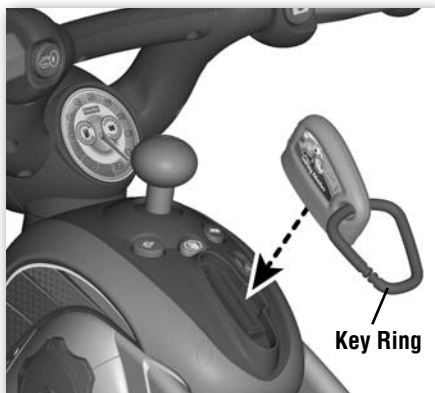

- Place the Smart Cycle® in front of your TV.
- Insert the plug on the end of the plug and play cord into the socket on the front of the cycle.

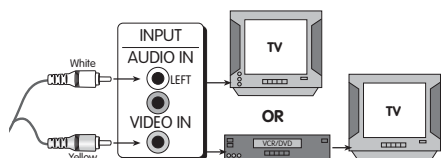

Important! Your TV or VCR/DVD player must have audio and video input jacks (located on the front or back of your TV or VCR/DVD).

- Plug the audio-video pins into the matching colored input jacks on your TV or VCR/DVD player (Yellow for Video In, White for Audio In).

- Insert the game cartridge into the socket on top of the cycle console. Push to be sure it is fully inserted.

Hint: You can easily attach other cartridges (sold separately and not included) to the key ring.

- Turn your TV or VCR/DVD player power **ON**.
- Slide the power switch on the cycle to **ON I**.
- To find the picture on your TV screen, set your TV's or VCR/DVD player's mode selector to INPUT or VIDEO IN.

Hint: The plug-and-play cord is designed to easily disconnect if it is pulled. Simply connect the matching connectors in the middle of the cord.

GETTING STARTED ON THE LEARNING ADVENTURE

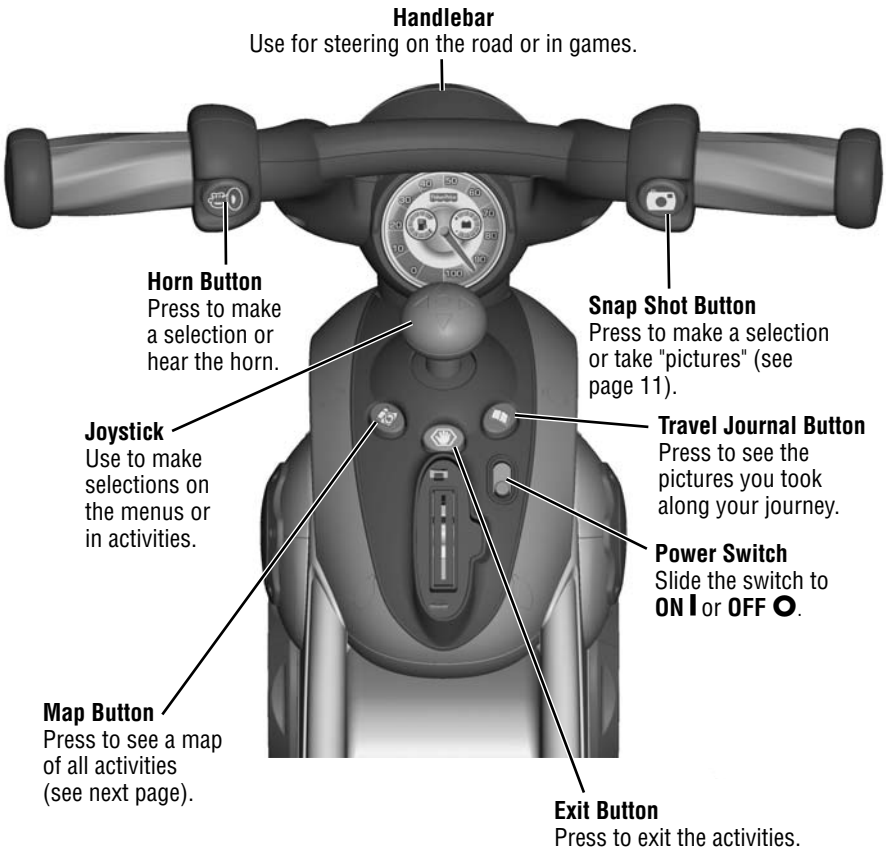



THE MAP

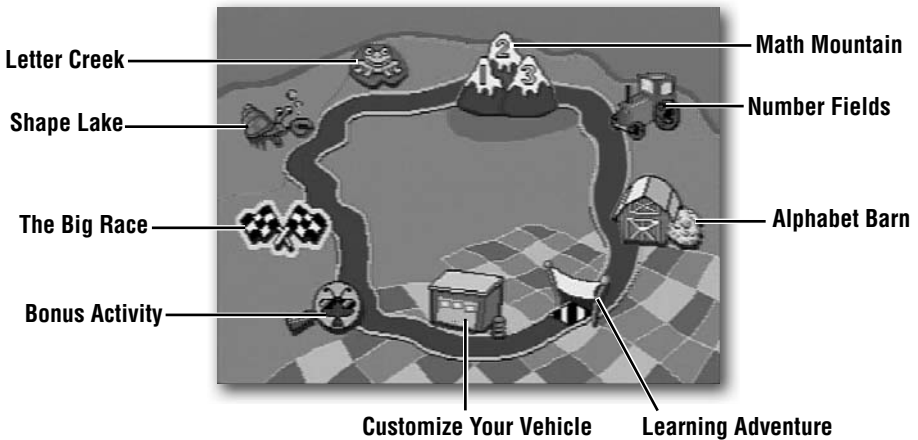

- You can travel down the road and head onto an off-ramp to access activities or simply press the map button  to visit any of the activities around the course.

NOTICE ABOUT EPILEPSY AND SEIZURES PLEASE READ THIS NOTICE BEFORE YOU OR YOUR CHILD USE ANY VIDEO GAME.

A very small portion of the population has a condition, which may cause a momentary loss of consciousness when viewing certain kinds of flashing lights or patterns that are commonly present in our daily environment. This condition may cause seizures while watching some kinds of television pictures or playing certain video games. Players who have not had any previous seizures may nonetheless have an undetected epileptic condition.

If you or anyone in your family has experienced symptoms linked to an epileptic condition (e.g. a seizure or loss of awareness), consult your physician before playing video games. We recommend that parents observe their children while they play video games. If you or your child experience any of the following symptoms such as dizziness, altered vision, eye or muscle twitching, involuntary movements, loss of awareness, disorientation or convulsions, **DISCONTINUE USE IMMEDIATELY** and consult your physician.

Additionally, please follow these precautions whenever playing a video game:

- Do not sit or stand too close to the television screen. Play as far back from the screen as possible.
- Do not play if you are tired or need sleep.
- Always play in a well lit room.
- Be sure to take a 10-15 minute break every hour while playing.



CUSTOMIZE YOUR VEHICLE



- Use the joystick to choose the type of vehicle you'd like to "drive."
- Press either handlebar button to make your selection.
- Repeat this process to choose the color of your vehicle, horn sound and a hood ornament style.



LEARNING ADVENTURE

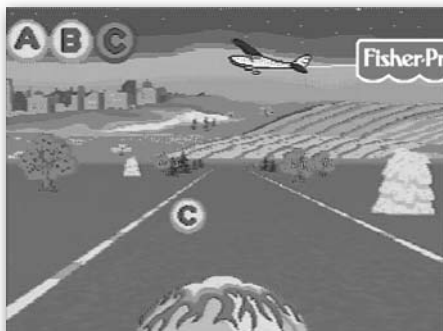

Find the objects!

- Pedal the cycle to move down the road.
The faster you pedal the faster you go!
- Use the handlebar to steer.
- Find all the letters, numbers or shapes shown in the upper left of the screen. Simply ride over them. Don't ride over other objects!

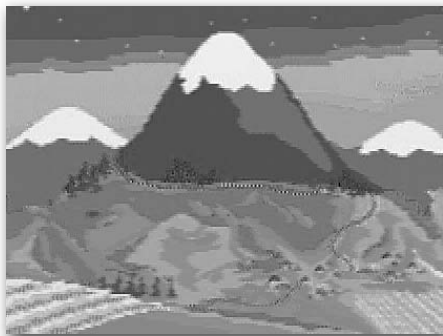

Taking Snap Shots

- Press the right handlebar button  to take snap shots.

Note: This feature is only available in this (Learning Adventure) activity.



ALPHABET BARN



Off Ramps

- Keep traveling down the road and go all the way around the course or head onto an off-ramp for other fun games and activities. Simply bear to the side of the road as you see one approaching.

Hint: If you miss a ramp, you can pedal in reverse to back up.



Find the Letters!

- Listen carefully to the letter you need to find. "Find the upper case G".
- Move the joystick to scroll through choices. Then press either handlebar button to choose a letter.



- Select the correct letter and you complete a word! "G - Goat"
- When you're finished with this activity, press the exit button  to return to the road. Pedal to the next activity!



LETTER CREEK



Word

Frog Lives

Score

Catch the letters to spell words!

- Look at the lower left corner of the screen for the word you need to spell. Watch the letter bugs fly across the screen.
- Use the joystick to move the frog left and right. Then, press either handlebar button to catch the letter bug.
- You have 5 frog lives available in each game. Don't choose the wrong letter or you will lose a life.
- Score points for every word you spell! Look at your score in the lower right corner of the screen.
- When you spell all words correctly on one level, move up to the next level.

Level 1 - Choose the correct letters, but be careful not to choose a shape or you'll lose a life.

Level 2 - Choose the correct letters, but be careful not to choose a number or you'll lose a life.

Level 3 - Choose the correct letters, but be careful not to choose the wrong letter or you'll lose a life.

- When you're finished with this activity, press the exit button  to return to the road. Pedal to the next activity!



THE BIG RACE



Pedal as fast as you can to the finish line!

- Use the joystick to choose a 1 Player or 2 Player game. Press either handlebar button to select the game.



1 Player

- Pedal down the road as fast as you can to the finish line. Try to speed past the other cars. Get to the finish line first and *you win!*



SHAPE LAKE



2 Player

- Each player takes a turn. Pedal down the road as fast as you can to the finish line. Look at your time.
- Now, it's time for Player 2 to beat your time.
- The player with the fastest time *wins*.
- When you're finished with this activity, press the exit button (🖱️) to return to the road. Pedal to the next activity!

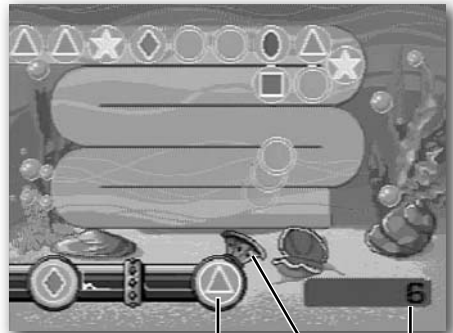

Shape Nozzle Score

Match shapes to pop the bubbles!

- Look at the shape inside the nozzle. Use the joystick to aim the nozzle toward the matching shape.
- Press either handlebar button to shoot the shape and "pop" the bubble.
- Hit the matching shape to pop the bubbles and score points! If you hit the wrong shape, the bubble is added to the line up.

Hint: The blowfish 🐡 can be used to hit any bubble shape.

- Try to pop all the bubbles before they reach the bottom. When you pop all the bubbles, move on to the next level. The bubbles move faster!
- When you're finished with this activity, press the exit button (🖱️) to return to the road. Pedal to the next activity!



MATH MOUNTAIN



Climb Math Mountain!

- Pedal to climb the mountain.



- Then, count how high you went!
- When you're finished with this activity, press the exit button  to return to the road. Pedal to the next activity!



NUMBER FIELDS



Timer

Score

Use the tractor to run over numbers in the field before they disappear!

- Use the joystick to move the tractor around the field. Run over the numbers before they disappear.
- When you hit the numbers, you score points! Try to get as many points as you can before time runs out and then move to the next level.

Hint: Pedal the cycle to go faster!

- In each level the numbers disappear faster and there are more obstacles to avoid. Don't hit the obstacles or you will lose points!
- When you're finished with this activity, press the exit button  to return to the road. Pedal to the next activity!

BONUS ACTIVITY

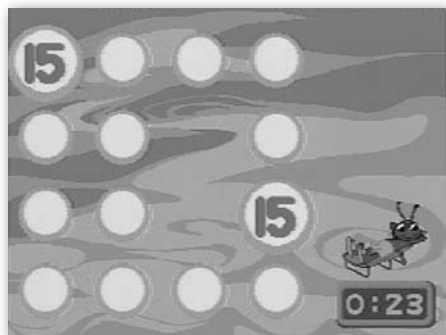

Complete all the activities and unlock the bonus activity!

- Play a matching game with the ants. Use the joystick to choose a circle. Then, press a handlebar button to flip it over.
- Flip another circle to find the match.
- Try to match all the circles.
- When you're finished with this activity, press the exit button  to return to the road. Pedal to the next activity!

TRAVEL JOURNAL





See previous
snap shot

See next
snap shot

- Press the travel journal button . Then use the joystick and handlebar buttons to review and select a snap shot.



Stamp Tool Erase

- Next, use the joystick and handlebar buttons to select the stamp tool  to decorate your picture.
- Choose a stamp with the joystick and handlebar buttons and place it on the snap shot.
- Select the erase button  to clear the screen and decorate another picture.

TROUBLESHOOTING GUIDE

PROBLEM	CAUSE	SOLUTION
No image on the TV	TV or VCR is not set to proper input	Press the channel down button on the VCR or TV and check for an INPUT channel below channel 2.
		Use the menu system on your TV or VCR to find INPUT or SOURCE. Change to INPUT or SOURCE.
		Refer to your TV's or VCR's instruction manual.
	Batteries in the cycle are weak or dead	Replace all batteries in the cycle with four, new "D" (LR20) alkaline batteries.
	Battery compartment door is loose	Fully tighten the screw in the battery compartment door.
	Plug-and-play cord is disconnected	Make sure both ends of the plug-and-play cords are fully connected to the cycle and your TV or VCR.
Game cartridge is not fully inserted into slot in cycle	Remove the game cartridge from the cycle slot. Replace the cartridge into the slot and push to be sure it is fully inserted.	
		Dust has accumulated in the game cartridge/cycle socket
Low battery symbol  appears on TV screen	Batteries in the cycle are weak	Replace all batteries in the cycle with four, new "D" (LR20) alkaline batteries.
Image is stretched or distorted on a wide screen TV	Wide screen TV aspect ratio set incorrectly	For best picture, do not use a 16:9 aspect ratio (stretched) wide screen setting. This product is designed for a regular screen TV with a 4:3 aspect ratio (display setting). When viewed on a wide screen TV, you will see black bars on the sides of the image. For more information on changing the aspect ratio, refer to your TV owner's manual.
Short battery life	NiMH or rechargeable batteries are being used	Use ONLY alkaline batteries in this product.

CONSUMER INFORMATION

?

CONSUMER ASSISTANCE

1-800-432-5437 (US & Canada)
1300 135 312 (Australia)

●

service.fisher-price.com

Fisher-Price, Inc., 636 Girard Avenue, East Aurora, NY 14052.
Hearing-impaired consumers: 1-800-382-7470.

Outside the United States:

Canada: Mattel Canada Inc., 6155 Freemont Blvd.,
Mississauga, Ontario L5R 3W2; www.service.mattel.com.

Great Britain: Mattel UK Ltd, Vanwall Business Park,
Maidenhead SL6 4UB. Helpline: 01628 500303.
www.service.mattel.com/uk

Mattel Europa, B.V., Gondel 1, 1186 MJ Amstelveen, Nederland.

Australia: Mattel Australia Pty. Ltd., 658 Church Street,
Locked Bag #870, Richmond, Victoria 3121 Australia.

New Zealand: 16-18 William Pickering Drive,
Albany 1331, Auckland.

Care

- We recommend storing the game cartridge in the socket on the console when not in use. This can help prevent dust from collecting in the socket (and causing a malfunction).
- Wipe with a clean cloth dampened with a mild soap and water solution. Do not use bleach. Do not use harsh or abrasive cleaners. Do not immerse.
- This product has no consumer serviceable parts. Do not take this product apart.
- Periodically check this product for wear and damage and replace any cracked part.

CONSUMER INFORMATION

FCC Statement (United States Only)

This equipment has been tested and found to comply with the limits for a Class B digital device, pursuant to Part 15 of the FCC Rules. These limits are designed to provide reasonable protection against harmful interference in a residential installation. This equipment generates, uses and can radiate radio frequency energy and, if not installed and used in accordance with the instructions, may cause harmful interference to radio communications. However, there is no guarantee that interference will not occur in a particular installation. If this equipment does cause harmful interference to radio or television reception, which can be determined by turning the equipment off and on, the user is encouraged to try to correct the interference by one or more of the following measures:

- Reorient or relocate the receiving antenna.
- Increase the separation between the equipment and receiver.
- Consult the dealer or an experienced radio/TV technician for help.

Note: Changes or modifications not expressly approved by the manufacturer responsible for compliance could void the user's authority to operate the equipment.

This device complies with Part 15 of the FCC Rules. Operation is subject to the following two conditions: (1) this device may not cause harmful interference and (2) this device must accept any interference received, including interference that may cause undesired operation.

ICES-003

- This Class B digital apparatus complies with Canadian ICES-003.
- Operation is subject to the following two conditions: (1) this device may not cause harmful interference and (2) this device must accept any interference received, including interference that may cause undesired operation.

NMB-003

- Cet appareil numérique de la classe B est conforme à la norme NMB-003 du Canada.
- L'utilisation de ce dispositif est autorisée seulement aux conditions suivantes : (1) il ne doit pas produire de brouillage et (2) l'utilisateur du dispositif doit être prêt à accepter tout brouillage radioélectrique reçu, même si ce brouillage est susceptible de compromettre le fonctionnement du dispositif.

Stretch your mind with other software titles for your Smart Cycle®!

Each sold separately and subject to availability.

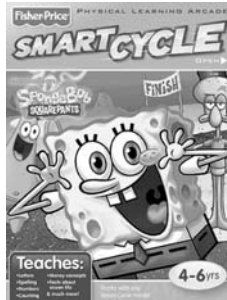
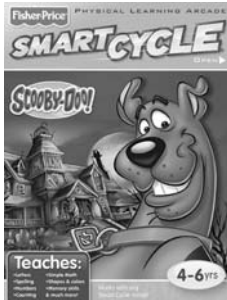
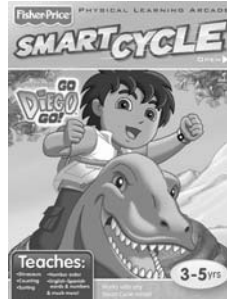

© 2010 Viacom International Inc. All Rights Reserved. Nickelodeon, Nick Jr., Dora the Explorer, Go, Diego, Go!, and all related titles, logos and characters are trademarks of Viacom International Inc.

© 2010 Viacom International Inc. All Rights Reserved. Nickelodeon, SpongeBob SquarePants and all related titles, logos and characters are trademarks of Viacom International Inc. SpongeBob SquarePants created by Stephen Hillenburg. *Stephen Hillenburg*

© 2010 Viacom International Inc. Nickelodeon and all related logos are trademarks of Viacom International Inc.

Based on the feature film "Madagascar." © 2010 DreamWorks Animation LLC. Madagascar, Madagascar: Escape 2 Africa and all related titles, logos and characters are trademarks of DreamWorks Animation LLC. All Rights Reserved.

Shrek Forever After™ & © 2010 DreamWorks Animation L.L.C.
Disney • Pixar elements © Disney • Pixar



SCOOBY-DOO and all related characters and elements are trademarks of and © Hanna-Barbera.
WB SHIELD: TM & © Warner Bros. Entertainment Inc.

(s10)



DC SUPER FRIENDS and all related characters and elements are trademarks of and © DC Comics.
WB SHIELD: TM & © Warner Bros. Entertainment Inc.

(s10)

HOT WHEELS and associated trademarks and trade dress are owned by, and used under license from Mattel, Inc.

© 2010 Mattel, Inc. All Rights Reserved.

Free Manuals Download Website

<http://myh66.com>

<http://usermanuals.us>

<http://www.somanuals.com>

<http://www.4manuals.cc>

<http://www.manual-lib.com>

<http://www.404manual.com>

<http://www.luxmanual.com>

<http://aubethermostatmanual.com>

Golf course search by state

<http://golfingnear.com>

Email search by domain

<http://emailbydomain.com>

Auto manuals search

<http://auto.somanuals.com>

TV manuals search

<http://tv.somanuals.com>