

  
**FMI PRODUCTS, LLC**

**UNVENTED (VENT-FREE) GAS  
LOG HEATER  
OWNER'S OPERATION AND  
INSTALLATION MANUAL**

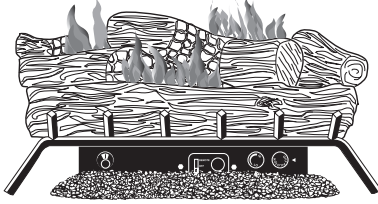

**FLAME-MAX® Multi-Sided Log Design**

**FVFM27NR, FVFM27PR, VYM27NR AND VYM27PR**  
Remote Control Ready Models

Also Design-Certified As A Vented Decorative Appliance

Patent Pending



We recommend that our products be installed and serviced by professionals who are certified in the U.S. by NFI (National Fireplace Institute).  
[www.nficertified.org](http://www.nficertified.org)

**⚠ WARNING:** If the information in this manual is not followed exactly, a fire or explosion may result causing property damage, personal injury or loss of life.

- Do not store or use gasoline or other flammable vapors and liquids in the vicinity of this or any other appliance.
- **WHAT TO DO IF YOU SMELL GAS**
  - Do not try to light any appliance.
  - Do not touch any electrical switch; do not use any phone in your building.
  - Immediately call your gas supplier from a neighbor's phone. Follow the gas supplier's instructions.
  - If you cannot reach your gas supplier, call the fire department.
- Installation and service must be performed by a qualified installer, service agency or the gas supplier.

**⚠ WARNING:** This is an unvented gas-fired heater. It uses air (oxygen) from the room in which it is installed. Provisions for adequate combustion and ventilation air must be provided. Refer to *Air for Combustion and Ventilation* section on page 6 of this manual.

**INSTALLER:** Leave this manual with the appliance.  
**CONSUMER:** Retain this manual for future reference.

For more information, visit [www.fmiproducts.com](http://www.fmiproducts.com)

## TABLE OF CONTENTS

Safety .....	2	Cleaning and Maintenance.....	23
Product Identification.....	5	Wiring Diagram.....	24
Local Codes.....	5	Troubleshooting.....	24
Unpacking.....	5	Specifications .....	28
Product Features.....	5	Replacement Parts.....	28
Remote Control Accessories.....	6	Service Hints.....	28
Air for Combustion and Ventilation.....	6	Technical Services.....	28
Installation.....	8	Accessories.....	29
Operation.....	18	Parts.....	30
Inspecting Burners.....	22	Warranty.....	Back Cover

## SAFETY

**⚠ WARNING:** Improper installation, adjustment, alteration, service or maintenance can cause injury or property damage. Refer to this manual for correct installation and operational procedures. For assistance or additional information consult a qualified installer, service agency or the gas supplier.

**This appliance may be installed in an aftermarket,\* permanently located, manufactured (mobile) home, where not prohibited by local codes.**

**This appliance is only for use with the type of gas indicated on the rating plate. This appliance is not convertible for use with other gases.**

\* Aftermarket: Completion of sale, not for purpose of resale, from the manufacturer

**⚠ WARNING:** This appliance is for installation only in a solid-fuel burning masonry or UL127 factory-built fireplace, or in a listed ventless firebox enclosure. It is design certified for these installations in accordance with ANSI Z21.11.2. Exception: Do not install this appliance in a factory-built fireplace that includes instructions stating it has not been tested or should not be used with unvented gas logs.

**⚠ WARNING:** This product contains and/or generates chemicals known to the State of California to cause cancer or birth defects, or other reproductive harm.

**IMPORTANT:** Read this owner's manual carefully and completely before trying to assemble, operate, or service this heater. Improper use of this heater can cause serious injury or death from burns, fire, explosion, electrical shock, and carbon monoxide poisoning.

# SAFETY

*Continued*

**⚠ DANGER: Carbon monoxide poisoning may lead to death!**

**Carbon Monoxide Poisoning:** Early signs of carbon monoxide poisoning resemble the flu, with headaches, dizziness, or nausea. If you have these signs, the heater may not be working properly. **Get fresh air at once!** Have heater serviced. Some people are more affected by carbon monoxide than others. These include pregnant women, people with heart or lung disease or anemia, those under the influence of alcohol, and those at high altitudes.

**Natural and Propane/LP Gas:** Natural and propane/LP gases are fuel gases. Fuel gases are odorless. An odor-making agent is added to fuel gases. The odor helps you detect a fuel gas leak. However, the odor added to fuel gas can fade. Fuel gas may be present even though no odor exists.

Make certain you read and understand all warnings. Keep this manual for reference. It is your guide to safe and proper operation of this heater.

**⚠ WARNING: Any change to this heater or its controls can be dangerous.**

**⚠ WARNING: Do not use a blower insert, heat exchanger insert, or other accessory not approved for use with this heater.**

**⚠ WARNING: Do not allow fans to blow directly into the fireplace. Avoid any drafts that alter burner flame patterns. Ceiling fans can create drafts that alter burner flame patterns. Altered burner patterns can cause sooting.**

**Due to high temperatures, the appliance should be located out of traffic and away from furniture and draperies.**

**Do not place clothing or other flammable material on or near the appliance. Never place any objects on the heater.**

**Heater base assembly becomes very hot when running heater. Keep children and adults away from hot surface to avoid burns or clothing ignition. Heater will remain hot for a time after shutdown. Allow surface to cool before touching.**

**Carefully supervise young children when they are in the room with heater. When using the hand-held remote accessory, keep selector switch in the OFF position to prevent children from turning on burners with remote.**

**You must operate this heater with a fireplace screen in place. Make sure fireplace screen is closed before running heater.**

**Keep the appliance area clear and free from combustible materials, gasoline, and other flammable vapors and liquids.**

1. This appliance is only for use with the type of gas indicated on the rating plate. This appliance is not convertible for use with other gases.
2. Do not place propane/LP supply tank(s) inside any structure. Locate propane/LP supply tank(s) outdoors (propane/LP units only).
3. To prevent performance problems, the use of a propane/LP tank of less than 100 lbs. capacity is not recommended (propane/LP units only).

# SAFETY

## Continued

4. If you smell gas
  - shut off gas supply
  - do not try to light any appliance
  - do not touch any electrical switch; do not use any phone in your building
  - immediately call your gas supplier from a neighbor's phone. Follow the gas supplier's instructions
  - if you cannot reach your gas supplier, call the fire department
5. This heater shall not be installed in a bedroom or bathroom unless installed as a vented appliance (see *Installing Damper Clamp Accessory for Vented Operation*, page 11). This gas log set may not be installed as a vented appliance in a bedroom or bathroom in the Commonwealth of Massachusetts.
6. Before installing in a solid fuel burning fireplace, the chimney flue and firebox must be cleaned of soot, creosote, ashes and loose paint by a qualified chimney cleaner. Creosote will ignite if highly heated. A dirty chimney flue may create and distribute soot within the house. Inspect chimney flue for damage. If damaged, repair flue and firebox before operating heater.
7. Do not burn solid-fuel in a masonry or UL127 factory-built fireplace in which a vent-free room heater is installed.
8. If fireplace has glass doors, never operate this heater with glass doors closed. If you operate heater with doors closed, heat buildup inside fireplace will cause glass to burst. Make sure there are no obstructions across openings of fireplace.
9. This log heater is designed to be smokeless. If logs ever appear to smoke, turn off heater and call a qualified service person. *Note:* During initial operation, slight smoking could occur due to log curing and heater burning manufacturing residues.
10. To prevent the creation of soot, follow the instructions in *Cleaning and Maintenance*, page 23.
11. Before using furniture polish, wax, carpet cleaner, or similar products, turn heater off. If heated, the vapors from these products may create a white powder residue within burner box or on adjacent walls or furniture.
12. This heater needs fresh, outside air ventilation to run properly. This heater has an oxygen depletion sensing (ODS) pilot light safety system. The ODS shuts down the heater if not enough fresh air is available. See *Air for Combustion and Ventilation*, page 6. If heater keeps shutting off, see *Troubleshooting*, page 24.
13. Do not run heater
  - where flammable liquids or vapors are used or stored
  - under dusty conditions
14. Do not use this heater to cook food or burn paper or other objects.
15. Do not use heater if any part has been exposed to or under water. Immediately call a qualified service technician to inspect the room heater and to replace any part of the control system and any gas control which has been under water.
16. Do not operate heater if any log is broken. Do not operate heater if a log is chipped (dime-sized or larger).
17. Turn heater off and let cool before servicing, installing, or repairing. Make sure the selector switch is in the OFF position. Only a qualified service person should install, service, or repair heater.
18. Make sure the selector switch is in the OFF position when you are away from home for long periods of time.
19. This heater must not be connected to any external electrical source.
20. Operating heater above elevations of 4,500 feet could cause pilot outage.
21. Provide adequate clearances around air openings.
22. Keep burner and control compartment clean.
23. Solid fuels shall not be burned in a fireplace in which an unvented room heater is installed.

## PRODUCT IDENTIFICATION

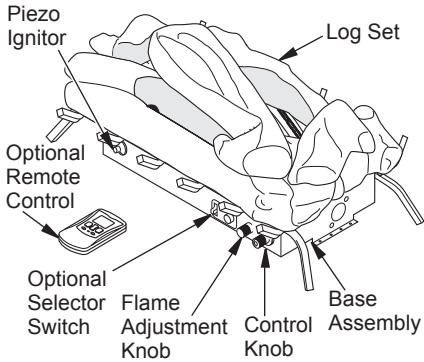

Figure 1 - Product Identification

## LOCAL CODES

Install and use heater with care. Follow all local codes. In the absence of local codes, use the latest edition of *The National Fuel Gas Code, ANSI Z223.1/NFPA 54\**.

\*Available from:

American National Standards Institute, Inc.  
1430 Broadway  
New York, NY 10018

National Fire Protection Association, Inc.  
Batterymarch Park  
Quincy, MA 02269

Note: Where listed vented decorative logs are required, thermostat operation is not permitted.

**State of Massachusetts:** The installation must be made by a licensed plumber or gas fitter in the Commonwealth of Massachusetts.

Sellers of unvented propane or natural gas-fired supplemental room heaters shall provide to each purchaser a copy of 527 CMR 30 upon sale of the unit.

Vent-free gas products are prohibited for bedroom and bathroom installation in the Commonwealth of Massachusetts.

## UNPACKING

**CAUTION:** Do not remove the data plates from the grate assembly. The data plates contain important product information warranty and safety information.

1. Remove logs and heater base assembly from carton. Note: Do not pick up heater base assembly by the burner. This could damage heater. Always handle base assembly by grate.
2. Remove all protective packaging applied to logs and heater for shipment.
3. Check all items for any shipping damage. If damaged, promptly inform dealer where you bought heater.

## PRODUCT FEATURES

### OPERATION

This heater is clean burning. It requires no outside venting. There is no heat loss out a vent or up a chimney. Heat is generated by realistic, dancing yellow flames. This heater is designed for vent-free operation with flue damper closed. It has been tested and approved to ANSI Z21.11.2 standard for unvented heaters. State and local codes in some areas prohibit the use of vent-free heaters. This heater may also be operated as a vented decorative product (ANSI Z21.60) by opening flue damper (non-thermostat operation only).

### APPLICATION

These multisided logs are designed to be equally beautiful when viewed from any angle. They are designed specifically for use in see-through, peninsula, and island fireboxes with multiple openings. You may also install this log heater in a standard firebox.

### SAFETY PILOT

This heater has a pilot with an Oxygen Depletion Sensing (ODS) safety shutoff system. The ODS/pilot is a required feature for vent-free room heaters. The ODS/pilot shuts off the heater if there is not enough fresh air.

### PIEZO IGNITION SYSTEM

This heater has a piezo ignitor. This system requires no matches, batteries, or other sources to light heater.

## REMOTE CONTROL ACCESSORIES

There are 4 optional controls that can be purchased separately for this log heater:

- wall switch
- wall thermostat
- hand-held ON/OFF remote
- hand-held thermostat remote

See [Accessories](#), page 29.

*Note: The wall thermostat or hand-held thermostat may not be used where vented decorative listing is required.*

## AIR FOR COMBUSTION AND VENTILATION

**⚠ WARNING: This heater shall not be installed in a room or space unless the required volume of indoor combustion air is provided by the method described in the *National Fuel Gas Code, ANSI Z223.1/NFPA 54*, the *International Fuel Gas Code*, or applicable local codes. Read the following instructions to insure proper fresh air for this and other fuel-burning appliances in your home.**

Today's homes are built more energy efficient than ever. New materials, increased insulation, and new construction methods help reduce heat loss in homes. Home owners weather strip and caulk around windows and doors to keep the cold air out and the warm air in. During heating months, home owners want their homes as airtight as possible.

While it is good to make your home energy efficient, your home needs to breathe. Fresh air must enter your home. All fuel-burning appliances need fresh air for proper combustion and ventilation.

Exhaust fans, fireplaces, clothes dryers, and fuel burning appliances draw air from the house to operate. You must provide adequate fresh air for these appliances. This will insure proper venting of vented fuel-burning appliances.

### PROVIDING ADEQUATE VENTILATION

The following are excerpts from *National Fuel Gas Code, ANSI Z223.1/NFPA 54, Air for Combustion and Ventilation*.

All spaces in homes fall into one of the three following ventilation classifications:

1. Unusually Tight Construction
2. Unconfined Space
3. Confined Space

The information on pages 6 through 8 will help

you classify your space and provide adequate ventilation.

#### Unusually Tight Construction

The air that leaks around doors and windows may provide enough fresh air for combustion and ventilation. However, in buildings of unusually tight construction, you must provide additional fresh air.

**Unusually tight construction is defined as construction where:**

- a. walls and ceilings exposed to the outside atmosphere have a continuous water vapor retarder with a rating of one perm ( $6 \times 10^{-11}$  kg per pa-sec- $m^2$ ) or less with openings gasketed or sealed and
- b. weather stripping has been added on openable windows and doors and
- c. caulking or sealants are applied to areas such as joints around window and door frames, between sole plates and floors, between wall-ceiling joints, between wall panels, at penetrations for plumbing, electrical, and gas lines, and at other openings.

**If your home meets all of the three criteria above, you must provide additional fresh air. See [Ventilation Air From Outdoors](#), page 8.**

**If your home does not meet all of the three criteria above, proceed to [Determining Fresh-Air Flow For Heater Location](#), page 7.**

#### Confined and Unconfined Space

*The National Fuel Gas Code, ANSI Z223.1/NFPA 54* defines a confined space as a space whose volume is less than 50 cubic feet per 1,000 Btu/hr (4.8  $m^3$  per kw) of the aggregate input rating of all appliances installed in that space and an unconfined space as a space whose volume is not less than 50 cubic feet per 1,000 Btu/hr (4.8  $m^3$  per kw) of the aggregate input rating of all appliances installed in that space. Rooms communicating directly with the space in which the appliances are installed\*, through openings not furnished with doors, are considered a part of the unconfined space.

\* Adjoining rooms are communicating only if there are doorless passageways or ventilation grills between them.

# AIR FOR COMBUSTION AND VENTILATION

Continued

## DETERMINING FRESH-AIR FLOW FOR HEATER LOCATION

### Determining if You Have a Confined or Unconfined Space

Use this work sheet to determine if you have a confined or unconfined space.

**Space:** Includes the room in which you will install heater plus any adjoining rooms with doorless passageways or ventilation grills between the rooms.

1. Determine the volume of the space (length x width x height).

Length x Width x Height = \_\_\_\_\_ c u. ft. (volume of space)

*Example:* Space size 20 ft. (length) x 16 ft. (width) x 8 ft. (ceiling height) = 2560 cu. ft. (volume of space)

If additional ventilation to adjoining room is supplied with grills or openings, add the volume of these rooms to the total volume of the space.

2. Multiply the space volume by 20 to determine the maximum Btu/Hr the space can support.

\_\_\_\_\_ (volume of space) x 20 = (Maximum Btu/Hr the space can support)

*Example:* 2560 cu. ft. (volume of space) x 20 = 51,200 (maximum Btu/Hr the space can support)

3. Add the Btu/Hr of all fuel burning appliances in the space.

Vent-free heater \_\_\_\_\_ Btu/Hr

Gas water heater\* \_\_\_\_\_ Btu/Hr

Gas furnace \_\_\_\_\_ Btu/Hr

Vented gas heater \_\_\_\_\_ Btu/Hr

Gas fireplace logs \_\_\_\_\_ Btu/Hr

Other gas appliances\* + \_\_\_\_\_ Btu/Hr

Total = \_\_\_\_\_ Btu/Hr

\* Do not include direct-vent gas appliances. Direct-vent draws combustion air from the outdoors and vents to the outdoors.

*Example:*

Gas water heater\* 40,000 Btu/Hr

Vent-free heater + 33,000 Btu/Hr

Total = 73,000 Btu/Hr

4. Compare the maximum Btu/Hr the space can support with the actual amount of Btu/Hr used.

\_\_\_\_\_ Btu/Hr (maximum the space can support)

\_\_\_\_\_ Btu/Hr (actual amount of Btu/Hr used)

*Example:* 51,200 Btu/Hr (maximum the space can support)

73,000 Btu/Hr (actual amount of Btu/Hr used)

The space in this example is a confined space because the actual Btu/Hr used is more than the maximum Btu/Hr the space can support. You must provide additional fresh air. Your options are as follows:

- A. Rework worksheet, adding the space of an adjoining room. If the extra space provides an unconfined space, remove door to adjoining room or add ventilation grills between rooms. See Ventilation Air From Inside Building.
- B. Vent room directly to the outdoors. See Ventilation Air From Outdoors, page 8.
- C. Install a lower Btu/Hr heater, if lower Btu/Hr size makes room unconfined.

If the actual Btu/Hr used is less than the maximum Btu/Hr the space can support, the space is an unconfined space. You will need no additional fresh air ventilation.

**⚠ WARNING: If the area in which the heater may be operated does not meet the required volume for indoor combustion air, combustion and ventilation air shall be provided by one of the methods described in the *National Fuel Gas Code, ANSI Z223.1/NFPA 54, the International Fuel Gas Code, or applicable local codes.***

## VENTILATION AIR

### Ventilation Air From Inside Building

This fresh air would come from an adjoining unconfined space. When ventilating to an adjoining unconfined space, you must provide two permanent openings: one within 12" of the ceiling and one within 12" of the floor on the wall connecting the two spaces (see options 1 and 2, Figure 2, page 8). You can also remove door into adjoining room (see option 3, Figure 2). Follow the *National Fuel Gas Code, ANSI Z223.1/NFPA 54, Air for Combustion and Ventilation* for required size of ventilation grills or ducts.

# AIR FOR COMBUSTION AND VENTILATION

Continued

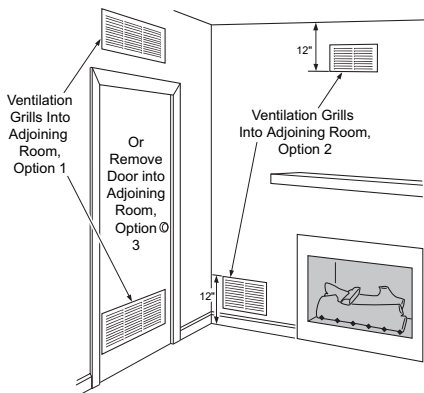

Figure 2 - Ventilation Air from Inside Building

## Ventilation Air From Outdoors

Provide extra fresh air by using ventilation grills or ducts. You must provide two permanent openings: one within 12" of the ceiling and one within 12" of the floor. Connect these

items directly to the outdoors or spaces open to the outdoors. These spaces include attics and crawl spaces. Follow the *National Fuel Gas Code, ANSI Z223.1/NFPA 54, Air for Combustion and Ventilation* for required size of ventilation grills or ducts.

**IMPORTANT:** Do not provide openings for inlet or outlet air into attic if attic has a thermostat-controlled power vent. Heated air entering the attic will activate the power vent.

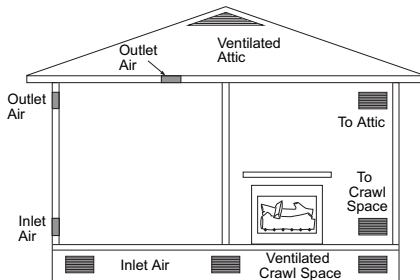

Figure 3 - Ventilation Air from Outdoors

## INSTALLATION

**NOTICE:** This heater is intended for use as supplemental heat. Use this heater along with your primary heating system. Do not install this heater as your primary heat source. If you have a central heating system, you may run system's circulating blower while using heater. This will help circulate the heat throughout the house. In the event of a power outage, you can use this heater as your primary heat source.

**WARNING:** A qualified service person must install heater. Follow all local codes.

**NOTICE:** State or local codes may only allow operation of this appliance in a vented configuration. Check your state or local codes.

**WARNING:** Before installing in a solid fuel burning fireplace, the chimney flue and firebox must be cleaned of soot, creosote, ashes and loose paint by a qualified chimney cleaner. Creosote will ignite if highly heated. A dirty chimney flue may create and distribute soot within the house. Inspect chimney flue and firebox for damage. If damaged, repair flue and firebox before operating heater.

**WARNING:** Seal any fresh air vents or ash clean-out doors located on floor or wall of fireplace. If not, drafting may cause pilot outage or sooting. Use a heat-resistant sealant. Do not seal chimney flue damper.



# INSTALLATION

Continued

**⚠ WARNING:** Never install the heater

- in a bedroom or bathroom unless installed as a vented appliance, see page 12
- in a recreational vehicle
- where curtains, furniture, clothing, or other flammable objects are less than 42" from the front, top, or sides of the heater
- in high traffic areas
- in windy or drafty areas

**⚠ CAUTION:** This heater creates warm air currents. These currents move heat to wall surfaces next to heater. Installing heater next to vinyl or cloth wall coverings or operating heater where impurities (such as, but not limited to, tobacco smoke, aromatic candles, cleaning fluids, oil or kerosene lamps, etc.) in the air exist, may discolor walls or cause odors.

**IMPORTANT:** Vent-free heaters add moisture to the air. Although this is beneficial, installing heater in rooms without enough ventilation air may cause mildew to form from too much moisture. See *Air for Combustion and Ventilation*, page 6.

## CHECK GAS TYPE

Use only the correct type of gas (natural or propane/LP). If your gas supply is not the correct gas type, do not install heater. Call dealer where you bought heater for proper type heater.

**⚠ WARNING:** This appliance is equipped for either natural gas or propane/LP gas but not both. Gas type is indicated on the rating plate. Field conversion is not permitted.

## INSTALLATION AND CLEARANCES (Vent-Free Operation Only)

**⚠ WARNING:** Maintain the minimum clearances. If you can, provide greater clearances from floor, ceiling, and adjoining wall.

**MINIMUM FIREPLACE CLEARANCE TO COMBUSTIBLE MATERIALS**  
Side Wall 16", Front 42", Ceiling 42"

### LOG SIZING REQUIREMENTS

Log Size	Minimum Firebox		
	Height	Depth	Width
27"	17"	19"	32"

Carefully follow the instructions below. This will ensure safe installation into a masonry, UL 127-listed manufactured fireplace, or listed vent-free firebox.

### Minimum Clearances For Side Combustible Material, Side Wall, and Ceiling

- A. Clearances from the side of the fireplace cabinet to any combustible material and wall should follow diagram in Figure 4.  
*Example:* The face of a mantel, bookshelf, etc. is made of combustible material and protrudes 3 1/2" from the wall. This combustible material must be 4" from the side of the fireplace cabinet (see Figure 4).  
*Note:* When installing your gas logs into a manufactured firebox, follow firebox manufacturer's instructions for minimum clearances to combustible materials.
- B. Clearances from the top of the fireplace opening to the ceiling should not be less than 42".

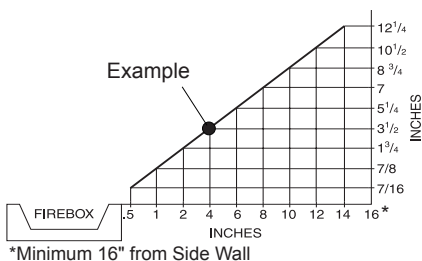

**Figure 4 - Minimum Clearance for Combustible to Wall**

# INSTALLATION

*Continued*

**NOTICE: Manual control heaters may be used as a vented product. If so, you must always run heater with chimney flue damper open. If running heater with damper open, noncombustible material above fireplace opening is not needed. Go to Installing Damper Clamp Accessory for Vented Operation, page 12.**

## MINIMUM NONCOMBUSTIBLE MATERIAL CLEARANCES

### If Not Using Mantel

*Note: If using a mantel, proceed to If Using Mantel. If not using a mantel, follow the information below.*

You must have noncombustible material(s) above both fireplace openings. Noncombustible materials (such as slate, marble, tile, etc.) must be at least 1/2" thick. With sheet metal, you must have noncombustible material behind it. Noncombustible material must extend at least 8" up. If noncombustible material is less than 12", you must install the fireplace hood accessory. See Figure 5 for minimum clearances.

**IMPORTANT:** If you cannot meet these minimum clearances, you must operate heater with chimney flue damper open. Go to Installing Damper Clamp Accessory for Vented Operation, page 12.

### If Using Mantel

You must have noncombustible material(s) above the fireplace opening. Noncombustible materials (such as slate, marble, tile, etc.) must be at least 1/2" thick. With sheet metal, you must have noncombustible material behind it. Noncombustible material must extend

at least 8" up. If noncombustible material is less than 12", you must install the fireplace hood accessory. Even if noncombustible material is more than 12", you may need the hood accessory to deflect heat away from your mantel shelf. See Figure 5 and Figures 6 and 7, page 11, for minimum clearances.

Noncombustible Material Distance (A)	Requirements for Safe Installation
12" or more	Noncombustible material OK.
Between 8" and 12"	Install fireplace hood accessory (GA6050 or GA6053 see <u>Accessories</u> , page 29).
Less than 8"	Noncombustible material must be extended to at least 8". See <u>Between 8" and 12"</u> , above. If you cannot extend material, you must operate heater with flue damper open.

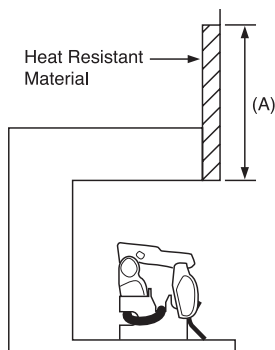

**Figure 5 - Heat Resistant Material (Slate, Marble, Tile, etc.) Above Fireplace**

# INSTALLATION

Continued

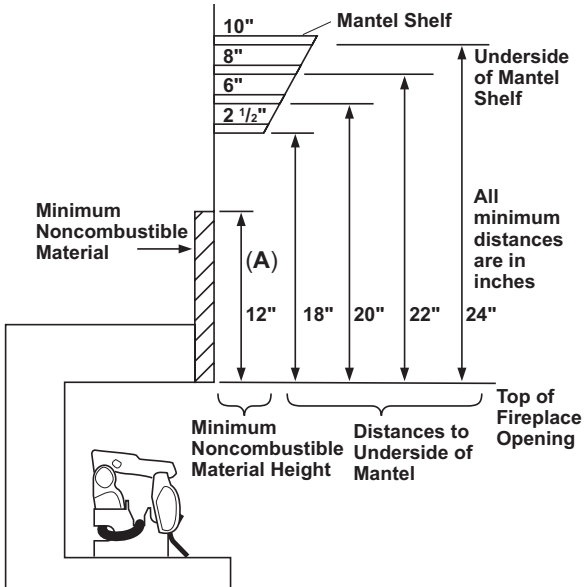

Figure 6 - Minimum Mantel Clearances Without Using Hood

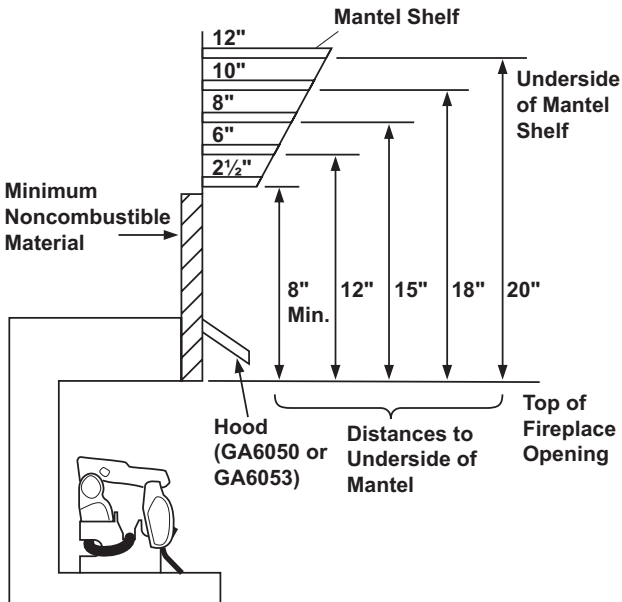

Figure 7 - Minimum Mantel Clearances When Using Hood

# INSTALLATION

Continued

## MANTEL CLEARANCES

In addition to meeting noncombustible material clearances, you must also meet required clearances between fireplace openings and mantel shelf on each side of the fireplace. If you do not meet the clearances listed below, you will need a hood.

### Determining Minimum Mantel Clearance

If you meet minimum clearance between mantel shelf and top of fireplace opening, a hood is not required (see Figure 6, page 11).

### Determining Minimum Mantel Clearance When using a Hood

If minimum clearances in Figure 6 are not met, you must have a hood. When using a hood there are still certain minimum mantel clearances required. Follow minimum clearances shown in Figure 7, page 11, when using hood.

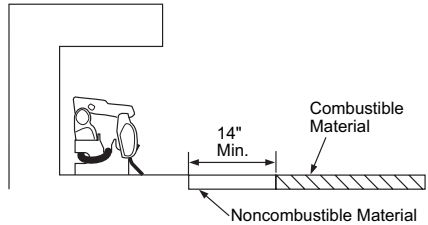

Figure 8 - Minimum Fireplace Clearances If Installed at Floor Level

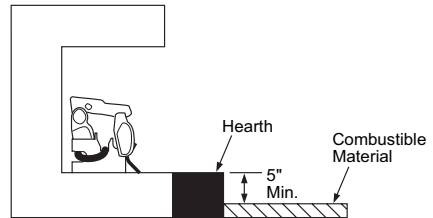

Figure 9 - Minimum Fireplace Clearances Above Combustible Flooring

**NOTICE: Surface temperatures of adjacent walls and mantels become hot during operation. Walls and mantels above the firebox may become hot to the touch. If installed properly, these temperatures meet the requirement of the national product standard. Follow all minimum clearances shown in this manual.**

**NOTICE: If your installation does not meet the minimum clearances shown, you must do one of the following:**

- operate the logs only with the flue damper open
- raise the mantel to an acceptable height
- remove the mantel

## FLOOR CLEARANCES

- A. If installing appliance on the floor level, you must maintain the minimum distance of 14" to combustibles (see Figure 8).
- B. If combustible materials are less than 14" to the fireplace, you must install appliance at least 5" above the combustible flooring (see Figure 9).

## INSTALLING DAMPER CLAMP ACCESSORY FOR VENTED OPERATION

*Note: When used as a vented heater, appliance must be installed only in a solid-fuel burning fireplace with a working flue and constructed of noncombustible material.*

**For Massachusetts Residents Only:** Installation of this vented gas log set in the Commonwealth of Massachusetts requires the damper be permanently removed or welded in the fully open position.

If your heater is a manually controlled model, you may use this heater as a vented product. There are three reasons for operating your heater in the vented mode:

1. The fireplace does not meet the clearance to combustibles requirements for vent-free operation
2. State or local codes do not permit vent-free operation
3. You prefer vented operation

If reasons number 1 or 2 above apply to you, you must permanently open chimney flue damper. You must install the damper clamp accessory (to order, see *Accessories*, page 29). This will insure vented operation (see Figure 10, page 13). The damper clamp will keep damper open. Installation instructions are included with clamp accessory.

# INSTALLATION

Continued

See chart below for minimum permanent flue opening you must provide. Attach damper clamp so the minimum permanent flue opening will be maintained at all times.

Chimney Height	Minimum Permanent Flue Opening
6' to 15'	39 sq. inches
15' to 30'	29 sq. inches

Area of Various Standard Round Flues	
Diameter	Area
5"	20 sq. inches
6"	29 sq. inches
7"	39 sq. inches
8"	51 sq. inches

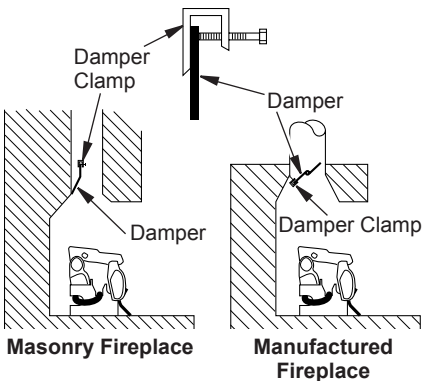

Figure 10 - Attaching Damper Clamp

## INSTALLING HEATER BASE ASSEMBLY

**CAUTION:** Do not remove the data plates attached to the heater base assembly. The data plates contain important warranty and safety information.

**WARNING:** You must secure this heater to fireplace floor. If not, heater will move when you adjust controls. Moving heater may cause a gas leak.

**WARNING:** If installing in a sunken fireplace, special care is needed. You must raise the fireplace floor to allow access to heater control panel. This will insure adequate air flow and guard against sooting and controls being damaged. Raise fireplace floor with noncombustible material. Make sure material is secure.

**CAUTION:** Do not pick up heater base assembly by the burner. This could damage heater. Only handle base assembly by grates.

**IMPORTANT:** Make sure the heater burner is level. If heater is not level, heater will not work properly.

### Installation Items Needed

- hardware package (provided with heater)
- approved flexible gas hose (provided) (if allowed by local codes)
- sealant (resistant to propane/LP gas, not provided)
- electric drill with 3/16" drill bit (metal or masonry as applicable)
- flathead screwdriver

1. Apply pipe joint sealant lightly to male threads of the fitting to be threaded into gas control. Connect approved flexible gas hose (provided for VYM models only) to gas control fitting in heater (see Figure 11). **IMPORTANT:** Hold gas fitting with wrench when connecting flexible gas hose.
2. Locate 2 masonry screws in hardware package.

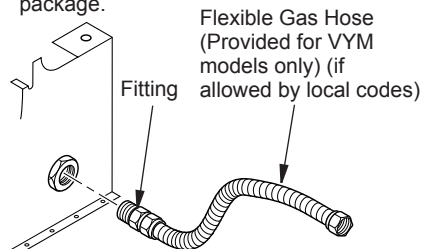

Figure 11 - Attaching Flexible Gas Hose to Heater

# INSTALLATION

Continued

3. Place heater base in fireplace.
4. Place logs in their proper position on heater base. See *Installing Logs*, page 17.
5. Center heater base and logs front-to-back and side-to-side in fireplace.
6. Carefully remove logs without moving heater base.
7. Mark screw locations through one hole on each side of the mounting bracket (see Figure 12). If installing in a brick-bottom fireplace, mark screw locations in mortar joint of bricks.
8. Remove heater base from fireplace. If installing optional control accessories, do so at this time. Follow all directions provided with accessory.
9. Drill holes at marked locations using 3/16" drill bit.
10. Attach base assembly to fireplace floor using two masonry screws (in hardware package).

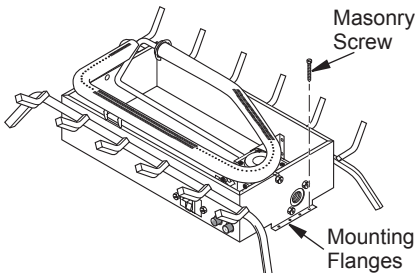

Figure 12 - Attaching Base Assembly to Fireplace Floor

## CONNECTING TO GAS SUPPLY

**⚠ WARNING: A qualified service person must connect heater to gas supply. Follow all local codes.**

**⚠ WARNING: Never connect propane/LP heater directly to the propane/LP supply. This heater requires an external regulator (not supplied). Install the external regulator between the heater and propane/LP supply.**

**⚠ WARNING: Never connect natural gas heater to private (non-utility) gas wells. This gas is commonly known as wellhead gas.**

### Installation Items Needed

Before installing heater, make sure you have the items listed below.

- external regulator (for propane/LP units only, supplied by installer)
- piping (check local codes)
- sealant (resistant to propane/LP gas)
- equipment shutoff valve \*
- test gauge connection \*
- sediment trap
- tee joint
- pipe wrench

\* A equipment shutoff valve with 1/8" NPT tap is an acceptable alternative to test gauge connection. Purchase the optional equipment shutoff valve from your dealer. See *Accessories*, page 29.

For propane/LP units, the installer must supply an external regulator. The external regulator will reduce incoming gas pressure. You must reduce incoming gas pressure to between 11" and 14" of water. If you do not reduce incoming gas pressure, heater regulator damage could occur. Install external regulator with the vent pointing down as shown in Figure 13. Pointing the vent down protects it from freezing rain or sleet.

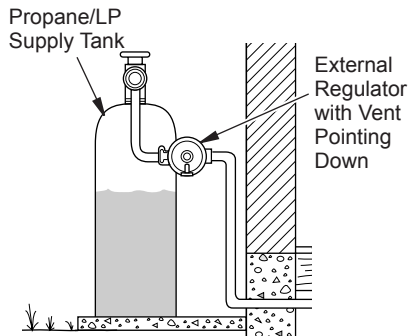

Figure 13 - External Regulator With Vent Pointing Down (Propane/LP gas only)

# INSTALLATION

Continued

**⚠ CAUTION:** Use only new, black iron or steel pipe. Internally-tinned copper tubing may be used in certain areas. Check your local codes. Use pipe of 1/2" diameter or greater to allow proper gas volume to heater. If pipe is too small, undue loss of volume will occur.

Installation must include an equipment shutoff valve, union, and plugged 1/8" NPT tap. Locate NPT tap within reach for test gauge hook up. NPT tap must be upstream from heater (see Figure 14).

**IMPORTANT:** Install equipment shutoff valve in an accessible location. The equipment shutoff valve is for turning on or shutting off the gas to the appliance.

Check your building codes for any special requirements for locating equipment shutoff valve to fireplaces.

Apply pipe joint sealant lightly to male NPT threads. This will prevent excess sealant from going into pipe. Excess sealant in pipe could result in clogged heater valves.

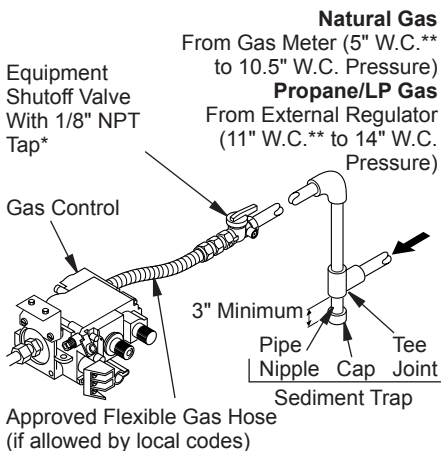

Figure 14 - Gas Connection

\* Purchase the optional equipment shutoff valve from your dealer. See [Accessories](#), page 29.

\*\* Minimum inlet pressure for purpose of input adjustment.

121353-01H

[www.fmiproducts.com](http://www.fmiproducts.com)

**⚠ WARNING:** Use pipe joint sealant that is resistant to liquid petroleum (LP) gas.

We recommend that you install sediment trap in supply line as shown in Figure 14. Locate sediment trap where it is within reach for cleaning. Install in piping system between fuel supply and heater. Locate sediment trap where trapped matter is not likely to freeze. A sediment trap traps moisture and contaminants. This keeps them from going into heater controls. If sediment trap is not installed or is installed wrong, heater may not run properly.

**⚠ CAUTION:** Avoid damage to control. Hold fitting with wrench when connecting it to gas piping and/or fittings.

## CHECKING GAS CONNECTIONS

**⚠ WARNING:** Test all gas piping and connections, internal and external to unit, for leaks after installing or servicing. Correct all leaks at once.

**⚠ WARNING:** Never use an open flame to check for a leak. Apply a noncorrosive leak detection fluid to all joints. Bubbles forming show a leak. Correct all leaks at once.

**⚠ CAUTION:** For propane/LP gas, make sure external regulator has been installed between propane/LP supply and heater. See guidelines under [Connecting to Gas Supply](#), page 14.

# INSTALLATION

Continued

## PRESSURE TESTING GAS SUPPLY PIPING SYSTEM

### Test Pressures In Excess Of 1/2 PSIG (14" W.C.)

1. Disconnect appliance with its appliance main gas valve (control valve) and equipment shutoff valve from gas supply piping system. Pressures in excess of 1/2 psig will damage heater regulator.
2. Cap off open end of gas pipe where equipment shutoff valve was connected.
3. Pressurize supply piping system by either opening propane/LP supply tank valve for propane/LP gas, or opening main gas valve located on or near gas meter for natural gas, or using compressed air.
4. Check all joints of gas supply piping system. Apply a noncorrosive leak detection fluid to gas joints. Bubbles forming show a leak.
5. Correct all leaks at once.
6. Reconnect heater and equipment shutoff valve to gas supply. Check reconnected fittings for leaks.

### Test Pressures Equal To or Less Than 1/2 PSIG (14" W.C.)

1. Close equipment shutoff valve (see Figure 15).
2. Pressurize supply piping system by either opening propane/LP supply tank valve for propane/LP gas, or opening main gas valve located on or near gas meter for natural gas, or using compressed air.
3. Check all joints from gas meter to equipment shutoff valve for natural gas or propane/LP supply to equipment shutoff valve for propane/LP (see Figure 16 or 17). Apply a noncorrosive leak detection fluid to gas joints. Bubbles forming show a leak.
4. Correct all leaks at once.

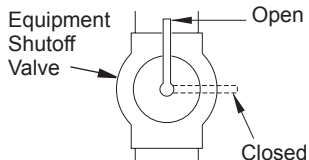

Figure 15 - Equipment Shutoff Valve

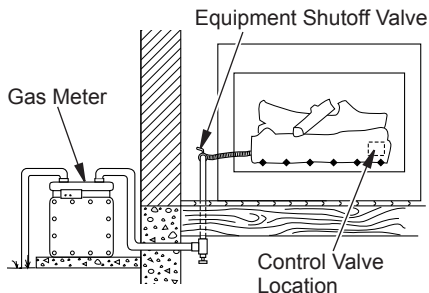

Figure 16 - Checking Gas Joints for Natural Gas

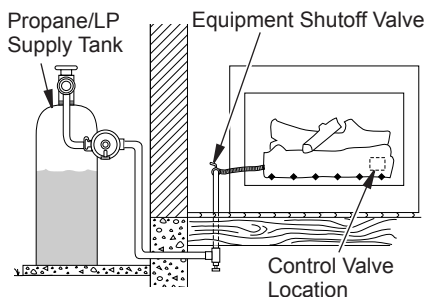

Figure 17 - Checking Gas Joints for Propane/LP Gas

## PRESSURE TESTING HEATER GAS CONNECTIONS

1. Open equipment shutoff valve (see Figure 15).
2. Open main gas valve located on or near gas meter for natural gas or open propane/LP supply tank valve.
3. Make sure control knob of heater is in the OFF position.
4. Check all joints from equipment shutoff valve to control valve (see Figure 16 or 17). Apply a noncorrosive leak detection fluid to gas joints. Bubbles forming show a leak.
5. Correct all leaks at once.
6. Light heater (see *Operation*, page 18). Check all other internal joints for leaks.
7. Turn off heater (see *To Turn Off Gas to Appliance*, page 20).



# INSTALLATION

Continued

## INSTALLING LOGS

**⚠ WARNING:** Failure to position the parts in accordance with these diagrams or failure to use only parts specifically approved with this heater may result in property damage or personal injury.

**⚠ CAUTION:** After installation and periodically thereafter, check to ensure that no flame comes in contact with any log. With the heater set to High, check to see if flames contact any log. If so, reposition logs according to the log installation instructions in this manual. Flames contacting logs will create soot.

It is very important to install the logs exactly as instructed. Do not modify logs. Only use logs supplied with heater.

NOTE: Log sets may come with either fiber pegs or metal pins. The following instructions can be followed for either design.

1. Place front log (#1) and rear log (#2) on grate to fit as illustrated in Figure 18.
2. Place center insert log (#3) as illustrated in Figure 19. Log should rest on burner and burner bracket. Do not block burner ports
3. Place top log (#4) and top right log (#5)

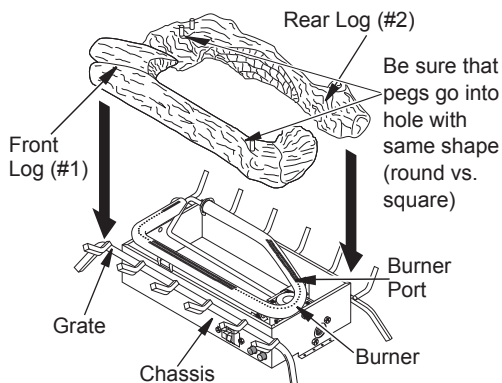

Figure 18 - Installing Front (#1) and Rear (#2) Logs

121353-01H

[www.fmiproducts.com](http://www.fmiproducts.com)

as illustrated in figure 20.

4. Make sure open areas of logs line up with burner ports (see figure 21). Logs will fit securely on chassis. **IMPORTANT:** Make sure log does not cover any burner ports.

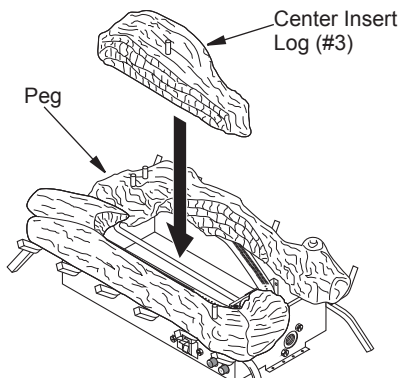

Figure 19 - Installing Center Insert Log (#3)

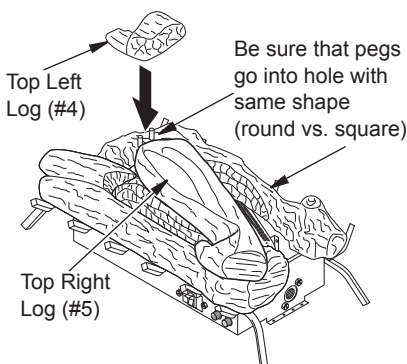

Figure 20 - Installing Top Left Log (#4) and Top Right Log (#5)

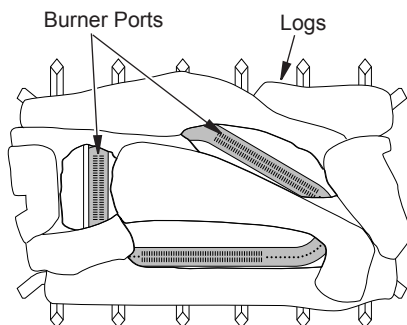

Figure 21 - Installing Log Set (Top View)

17

## OPERATION

### FOR YOUR SAFETY READ BEFORE LIGHTING

**⚠ WARNING:** If you do not follow these instructions exactly, a fire or explosion may result causing property damage, personal injury or loss of life.

- A. This appliance has a pilot which must be lighted by hand. When lighting the pilot, follow these instructions exactly.
- B. **BEFORE LIGHTING** smell all around the appliance area for gas. Be sure to smell next to the floor because some gas is heavier than air and will settle on the floor.

#### WHAT TO DO IF YOU SMELL GAS

- Do not try to light any appliance.
  - Do not touch any electric switch; do not use any phone in your building.
  - Immediately call your gas supplier from a neighbor's phone. Follow the gas supplier's instructions.
  - If you cannot reach your gas supplier, call the fire department.
- C. Use only your hand to push in or turn the gas control knob. Never use tools. If the knob will not push in or turn by hand, don't try to repair it, call a qualified service technician or gas supplier. Force or attempted repair may result in a fire or explosion.
- D. Do not use this appliance if any part has been under water. Immediately call a qualified service technician to inspect the appliance and to replace any part of the control system and any gas control which has been under water.

### LIGHTING INSTRUCTIONS

- ⚠ WARNING:**
- If fireplace has glass doors, never operate this heater with glass doors closed. If you operate heater with doors closed, heat buildup inside fireplace will cause glass to burst. Make sure there are no obstructions across openings of fireplace.
  - You must operate this heater with a fireplace screen in place. Make sure fireplace screen is closed before running heater.

**NOTICE:** During initial operation of new heater, burning logs will give off a paper-burning smell. Open damper or window to vent smell. This will only last a few hours.

*Note: Homeowners generally prefer to operate their heater with the chimney damper closed. This will put all the heat into the room. However, there may be times you will desire the full flames of the HI heat setting but will find the heat output excessive. You can open the chimney damper (if you have one) fully or partially to release some of the heat.*

**⚠ WARNING:** Damper handle will be hot if heater has been running.

1. STOP! Read the safety information, column 1.
2. Make sure equipment shutoff valve is fully open.
3. Set switch in the OFF position.

**⚠ WARNING:** Burner will come on automatically within one minute when the selector switch is in the ON position after the pilot is lit.

4. Press in and turn control knob clockwise  to the OFF position.

# OPERATION

## Continued

- Wait five (5) minutes to clear out any gas. Then smell for gas, including near the floor. If you smell gas, STOP! Follow "B" in the safety information, page 18. If you don't smell gas, go to the next step.
- Press in and turn control knob counterclockwise ↶ to the PILOT position. Press in control knob for five (5) seconds (see Figure 22).

*Note: You may be running this heater for the first time after hooking up to gas supply. If so, the control knob may need to be pressed in for 30 seconds or more. This will allow air to bleed from the gas system.*

- With control knob pressed in, press and release ignitor button. This will light pilot. The pilot is attached to the front burner. If needed, keep pressing ignitor button until pilot lights.

*Note: If pilot does not stay lit, contact a qualified service person or gas supplier for repairs. Until repairs are made, light pilot with match. To light pilot with match, see Manual Lighting Procedure.*

- Keep control knob pressed in for 30 seconds after lighting pilot. After 30 seconds, release control knob.

• If control knob does not pop out when released, contact a qualified service person or gas supplier for repairs.

*Note: If pilot goes out, repeat steps 4 through 8.*

- Slightly push in and turn control knob counterclockwise ↶ to the ON position.

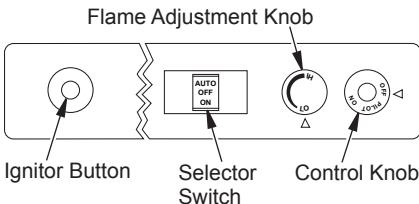
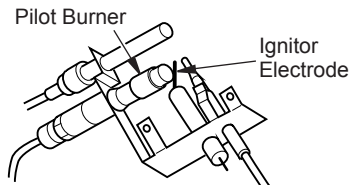

**Figure 22 - Control Knob and Ignitor Button Location (Shown as Supplied, No Control Options)**

- Wait one minute and switch selector switch to the ON position to light burner. *Note: AUTO is only functional when using GWMT1, or GWMS2 optional accessories.*
- Set flame adjustment knob to any level between HI and LO.
- To shut off burner and keep pilot lit do one of the following: Turn control knob clockwise ↷ to the PILOT position, use remote control manual OFF button or set selector switch in the OFF position.

**CAUTION:** Do not try to adjust heating levels by using the equipment shutoff valve.

**WARNING:** Make sure the selector switch is in the OFF position when you are away from home for long periods of time. Heater will come on automatically with selector switch in the ON position.



**Figure 23 - Natural Gas Pilot**

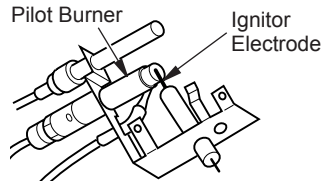

**Figure 24 - Propane/LP Gas Pilot**

## OPERATION

Continued

### TO TURN OFF GAS TO APPLIANCE

1. Turn control knob clockwise to the OFF position.
- 2a. Set selector switch in the OFF position.
- 2b. **If Using Optional Hand-Held Remote:** Set selector switch in the OFF position to prevent draining battery.
3. Close equipment shutoff valve (see Figure 15, page 16).

### MANUAL LIGHTING PROCEDURE

1. Follow steps 1 through 6 under Lighting Instructions, page 18.
2. Press control knob and light pilot with match.
3. Keep control knob pressed in for 30 seconds after lighting pilot. After 30 seconds, release control knob. Now follow steps 9 through 11 under Lighting Instructions, page 19.

### OPTIONAL HAND-HELD REMOTE OPERATION

All remote control accessories must be purchased separately (see Accessories, page 29). Follow instructions included with the remote control.

**NOTICE:** You must light the pilot before using the hand-held remote control unit. See Lighting Instructions on page 18.

After lighting, let pilot flame burn for about one minute. Turn control knob to ON position. Adjust flame adjustment knob anywhere between HI and LO. Slide the selector switch to the REMOTE position (see Figure 25).

*Note: The burner may light if hand-held remote was on when selector switch was last turned off. You can now turn the burner on and off with the hand-held remote control unit.*

**IMPORTANT:** Do not leave the selector switch in the REMOTE or ON position when the pilot is not lit. This will drain the battery.

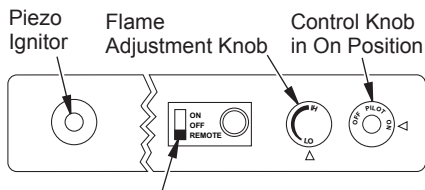

Selector Switch in Remote Position (Optional Hand-Held Remote Control)

**Figure 25 - Setting the Selector Switch, Control Knob, and Flame Adjustment Knob for Hand-Held Remote Operation**

### ON/OFF SERIES (MODEL HRC100)

Hold the control button on the hand-held remote until burner turns on. Hold the control button again until burner turns off (see Figure 26).

**To Lock** press both buttons on hand-held remote control until light stops flashing. Hand-held remote control is now locked. If the fire is on it will be turned off automatically. In the locked state, the light will not light up when any button is pressed.

**To Unlock** press both buttons together on hand-held remote control until the light stops flashing. The hand-held remote is now unlocked.

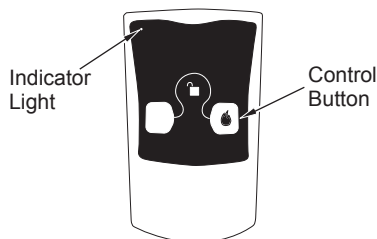

**Figure 26 - On/Off Hand-Held Remote Control Unit**

# OPERATION

*Continued*

## THERMOSTAT SERIES (MODEL HRC200)

The hand-held remote can be operated using either the manual mode (MANU) or thermostatic mode (AUTO) (see Figure 27). To select Fahrenheit/Centigrade mode display, carefully press the °C/°F mode button with the end of a paper clip or similar blunt object.

### Manual Mode

1. Press the POWER and LOCK buttons together to turn on the hand-held remote control.
2. Press the MANU button to turn on the fireplace.
3. Press the POWER and LOCK buttons together to turn off the fireplace.

### Auto (Thermostatic) Mode

1. Press the POWER and LOCK buttons together to turn on the hand-held remote control.
2. Press AUTO button to select this mode.
3. Set the desired room temperature by pressing the TEMP + or - buttons.
4. Press the POWER and LOCK buttons together to turn off the fireplace

*Note: Do not leave the hand-held remote in the AUTO mode close to the fireplace. The radiant heat from the fireplace will turn off the fireplace. Ideally, place the hand-held remote in the center of the room facing towards the fireplace.*

*Note: Do not hold the hand-held remote for a long time. Body temperature will affect its operation in the AUTO mode.*

### Safety Features

When away from home for an extended period of time or as a child safety feature to prevent accidental ignition of the fireplace, the receiver ON/OFF/REMOTE switch should be in the OFF position.

### Auto Shutoff Feature

1. If the average room temperature reaches a range of 82° F (28° C) to 92° F (33° C), the hand-held remote control will perform a safety override and shut the fireplace off. This feature is not available in the MANU mode.
2. The receiver continuously receives signals from the hand-held remote to control the room temperature. If the hand-held remote is misplaced, obstructed or for any reason cannot transmit to the receiver, the receiver will shut off the fireplace. This will occur in 8 or more minutes depending upon location of remote transmitter and strength of batteries.

### Key Pad Lock Feature

This feature allows the user to lock/unlock the keypad on the hand-held remote in the MANU or AUTO mode to prevent inadvertent operation (i.e. children operating the hand-held remote control, etc.). The keypad is locked in either on or off. Press the POWER and LOCK buttons together to turn the unit on or off.

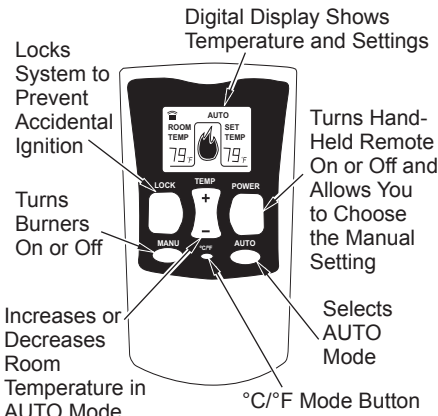

**Figure 27 - Thermostat Hand-Held Remote Control Unit**

## INSPECTING BURNERS

Check pilot flame pattern and burner flame patterns often.

### PILOT FLAME PATTERN

Figure 28 shows a correct pilot flame pattern. Figure 29 shows an incorrect pilot flame pattern. The incorrect pilot flame is not touching the thermocouple. When the thermocouple cools, the heater will shut down.

If pilot flame pattern is incorrect, as shown in Figure 29

- turn heater off (see [To Turn Off Gas to Appliance](#), page 20)
- see [Troubleshooting](#), page 24

*Note: The pilot flame on natural gas units will have a slight curve, but flame should be blue and have no yellow or orange color.*

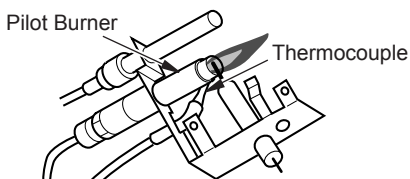

**Figure 28 - Correct Pilot Flame Pattern (Propane/LP Pilot Shown)**

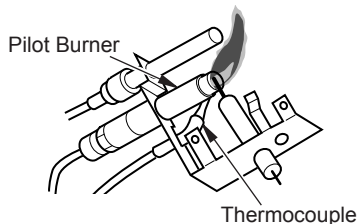

**Figure 29 - Incorrect Pilot Flame Pattern (Propane/LP Pilot Shown)**

### BURNER FLAME PATTERN

Figure 30 shows a correct burner flame pattern. Figure 31 shows an incorrect burner flame pattern.

If burner flame pattern is incorrect as shown in Figure 31

- turn heater off (see [To Turn Off Gas to Appliance](#), page 20)
- see [Troubleshooting](#), page 24



**Figure 30 - Correct Flame Pattern**

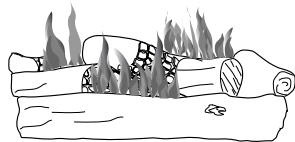

**Figure 31 - Incorrect Flame Pattern**

### BURNER PRIMARY AIR HOLES

Air is drawn into the burner through the holes in the fitting at the burner entrance. These holes may become blocked with dust or lint. Periodically inspect these holes for any blockage and clean if needed. Blocked air holes will create soot.

### MAIN BURNER

Periodically inspect all burner flame holes with the heater running. All slotted burner flame holes should be open with yellow flame present. All round burner flame holes should be open with a small blue flame present. Some burner flame holes may become blocked by debris or rust, with no flame present. If so, turn off heater and let cool. Remove blockage, blocked burner flame holes will create soot.

## CLEANING AND MAINTENANCE

**⚠ WARNING:** Turn off heater and let cool before cleaning.

**⚠ CAUTION:** You must keep control areas, burner, and circulating air passageways of heater clean. Inspect these areas of heater before each use. Have heater inspected yearly by a qualified service person. Heater may need more frequent cleaning due to excessive lint from carpeting, bedding material, pet hair, etc.

**⚠ WARNING:** Failure to keep the primary air opening(s) of the burner(s) clean may result in sooting and property damage.

### CLEANING BURNER INJECTOR HOLDER AND PILOT AIR INLET HOLE

The primary air inlet holes allow the proper amount of air to mix with the gas. This provides a clean burning flame. Keep these holes clear of dust, dirt, lint, and pet hair. Clean these air inlet holes prior to each heating season. Blocked air holes will create soot. We recommend that you clean the unit every three months during operation and have heater inspected yearly by a qualified service person.

We also recommend that you keep the burner tube and pilot assembly clean and free of dust and dirt. To clean these parts we recommend using compressed air no greater than 30 PSI. Your local computer store, hardware store, or home center may carry compressed air in a can. If using compressed air in a can, please follow the directions on the can. If you don't follow directions on the can, you could damage the pilot assembly.

1. Shut off unit, including pilot. Allow unit to cool for at least thirty minutes.
2. Inspect burner, pilot, and primary air inlet holes on injector holder for dust and dirt (see Figure 32).
3. Blow air through the ports/slots and holes in the burner.

4. Check injector holder located at end of burner tube again. Remove any large particles of dust, dirt, lint, or pet hair with a soft cloth or vacuum cleaner nozzle.
5. Blow air into the primary air holes on the injector holder.
6. In case any large clumps of dust have now been pushed into the burner repeat steps 3 and 4.

Clean pilot assembly also. A yellow tip on pilot flame indicates dust and dirt in the pilot assembly. There is a small pilot air inlet hole about 2" from where the pilot flame comes out of pilot assembly (see Figure 33). With unit off, lightly blow air through air inlet hole. You may blow through a drinking straw if compressed air is not available.

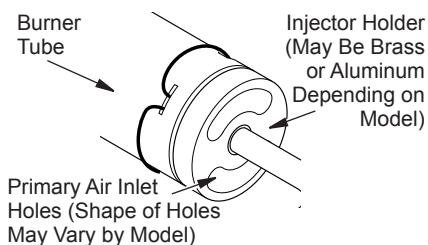

**Figure 32 - Injector Holder On Outlet Burner Tube**

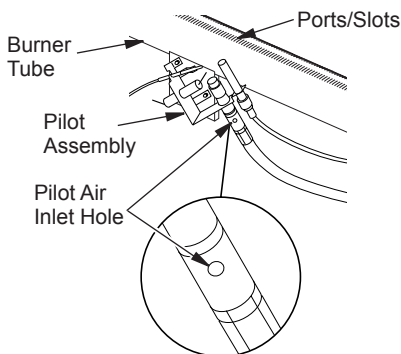

**Figure 33 - Pilot Inlet Air Hole**

### LOGS

- If you remove logs for cleaning, refer to [Installing Logs](#), page 17, to properly replace logs.
- Replace log(s) if broken or chipped (dime-sized or larger).

## WIRING DIAGRAM

Note: For proper operation of optional accessories, the wires from the switch to the control must be connected exactly as shown.

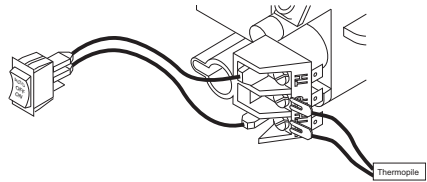

## TROUBLESHOOTING

**⚠ WARNING:** Turn off heater and let cool before servicing. Only a qualified service person should service and repair heater.

**⚠ CAUTION:** Never use a wire, needle, or similar object to clean ODS/pilot. This can damage ODS/pilot unit.

Note: All troubleshooting items are listed in order of operation.

OBSERVED PROBLEM	POSSIBLE CAUSE	REMEDY
When ignitor button is pressed, there is no spark at ODS/pilot	<ol style="list-style-type: none"> <li>1. Ignitor electrode not connected to ignitor cable</li> <li>2. Ignitor cable pinched or wet</li> <li>3. Piezo ignitor nut is loose</li> <li>4. Broken ignitor cable</li> <li>5. Bad piezo ignitor</li> <li>6. Ignitor electrode broken</li> <li>7. Ignitor electrode positioned wrong</li> </ol>	<ol style="list-style-type: none"> <li>1. Reconnect ignitor cable</li> <li>2. Free ignitor cable if pinched by any metal or tubing. Keep ignitor cable dry</li> <li>3. Tighten nut holding piezo ignitor to base panel of log set. Nut is located behind base panel</li> <li>4. Replace ignitor cable</li> <li>5. Replace piezo ignitor</li> <li>6. Replace pilot assembly</li> <li>7. Replace pilot assembly</li> </ol>
When ignitor button is pressed, there is spark at ODS/pilot but no ignition	<ol style="list-style-type: none"> <li>1. Gas supply turned off or equipment shutoff valve closed</li> <li>2. Control knob not in PILOT position</li> <li>3. Control knob not pressed in while in PILOT position</li> <li>4. Air in gas lines when installed</li> <li>5. Depleted gas supply (propane/LP gas)</li> <li>6. ODS/pilot is clogged</li> <li>7. Gas regulator setting is not correct</li> </ol>	<ol style="list-style-type: none"> <li>1. Turn on gas supply or open equipment shutoff valve</li> <li>2. Turn control knob to PILOT position</li> <li>3. Press in control knob while in PILOT position</li> <li>4. Continue holding down control knob. Repeat igniting operation until air is removed</li> <li>5. Contact local propane/LP gas company</li> <li>6. Clean ODS/pilot (see <i>Cleaning and Maintenance</i>, page 23) or replace ODS/pilot assembly</li> <li>7. Replace gas control</li> </ol>



# TROUBLESHOOTING

*Continued*

OBSERVED PROBLEM	POSSIBLE CAUSE	REMEDY
<p>ODS/pilot lights but flame goes out when control knob is released</p>	<ol style="list-style-type: none"> <li>1. Control knob not fully pressed in</li> <li>2. Control knob not pressed in long enough</li> <li>3. Equipment shutoff valve not fully open</li> <li>4. Pilot flame not touching thermocouple, which allows thermocouple to cool, causing pilot flame to go out. This problem could be caused by one or both of the following: A) Low gas pressure B) Dirty or partially clogged ODS/pilot</li> <li>5. Thermocouple connection loose at control valve</li> <li>6. Thermocouple damaged</li> <li>7. Control valve damaged</li> </ol>	<ol style="list-style-type: none"> <li>1. Press in control knob fully</li> <li>2. After ODS/pilot lights, keep control knob pressed in 30 seconds</li> <li>3. Fully open equipment shut-off valve</li> <li>4. A) Contact local natural or propane/LP gas company  B) Clean ODS/pilot (see <u><a href="#">Cleaning and Maintenance</a></u>, page 23) or replace ODS/pilot assembly</li> <li>5. Hand tighten until snug, then tighten 1/4 turn more</li> <li>6. Replace pilot assembly</li> <li>7. Replace control valve</li> </ol>
<p>Burner does not light after ODS/pilot is lit</p>	<ol style="list-style-type: none"> <li>1. Burner orifice clogged</li> <li>2. Inlet gas pressure is too low</li> <li>3. Thermopile leads disconnected or improperly connected</li> <li>4. Burners will not come on in remote position</li> </ol>	<ol style="list-style-type: none"> <li>1. Clean burner (see <u><a href="#">Cleaning and Maintenance</a></u>, page 23) or replace burner orifice</li> <li>2. Contact local natural or propane/LP gas company</li> <li>3. Reconnect leads (see <u><a href="#">Wiring Diagram</a></u>, page 24)</li> <li>4. Replace battery in transmitter and receiver</li> </ol>
<p>Delayed ignition burner</p>	<ol style="list-style-type: none"> <li>1. Manifold pressure is too low</li> <li>2. Burner orifice clogged</li> </ol>	<ol style="list-style-type: none"> <li>1. Contact local natural or propane/LP gas company</li> <li>2. Clean burner (see <u><a href="#">Cleaning and Maintenance</a></u>, page 23) or replace burner orifice</li> </ol>
<p>Burner backfiring during combustion</p>	<ol style="list-style-type: none"> <li>1. Burner orifice is clogged or damaged</li> <li>2. Damaged burner</li> <li>3. Gas regulator defective</li> </ol>	<ol style="list-style-type: none"> <li>1. Clean burner (see <u><a href="#">Cleaning and Maintenance</a></u>, page 23) or replace burner orifice</li> <li>2. Replace damaged burner</li> <li>3. Replace gas control</li> </ol>

# TROUBLESHOOTING

*Continued*

OBSERVED PROBLEM	POSSIBLE CAUSE	REMEDY
Slight smoke or odor during initial operation	<ol style="list-style-type: none"><li>1. Not enough air</li><li>2. Gas regulator defective</li><li>3. Residues from manufacturing processes and logs curing</li></ol>	<ol style="list-style-type: none"><li>1. Check burner for dirt and debris. If found, clean burner (see <i>Cleaning and Maintenance</i>, page 23)</li><li>2. Replace gas control</li><li>3. Problem will stop after a few hours of operation</li></ol>
Moisture/condensation noticed on windows	<ol style="list-style-type: none"><li>1. Not enough combustion/ventilation air</li></ol>	<ol style="list-style-type: none"><li>1. Refer to <i>Air for Combustion and Ventilation</i> requirements (page 6)</li></ol>
Heater produces a whistling noise when burner is lit	<ol style="list-style-type: none"><li>1. Turning control knob to HI position when burner is cold</li><li>2. Air in gas line</li><li>3. Air passageways on heater blocked</li><li>4. Dirty or partially clogged burner orifice</li></ol>	<ol style="list-style-type: none"><li>1. Turn control knob to LO position and let warm up for a minute</li><li>2. Operate burner until air is removed from line. Have gas line checked by local natural or propane/LP gas company</li><li>3. Observe minimum installation clearances (see pages 9 through 12)</li><li>4. Clean burner (see <i>Cleaning and Maintenance</i>, page 23) or replace burner orifice</li></ol>
White powder residue forming within burner box or on adjacent walls or furniture	<ol style="list-style-type: none"><li>1. When heated, vapors from furniture polish, wax, carpet cleaners, etc. may turn into white powder residue</li></ol>	<ol style="list-style-type: none"><li>1. Turn heater off when using furniture polish, wax, carpet cleaners, or similar products</li></ol>
Remote does not function	<ol style="list-style-type: none"><li>1. Battery is not installed. Battery power is low</li></ol>	<ol style="list-style-type: none"><li>1. Replace 9-volt batteries in receiver and hand-held remote</li></ol>
Heater produces a clicking/ticking noise just after burner is lit or shut off	<ol style="list-style-type: none"><li>1. Metal expanding while heating or contracting while cooling</li></ol>	<ol style="list-style-type: none"><li>1. This is normal with most heaters. If noise is excessive, contact qualified service person</li></ol>

# TROUBLESHOOTING

*Continued*



**WARNING: If you smell gas**

- Shut off gas supply.
- Do not try to light any appliance.
- Do not touch any electrical switch; do not use any phone in your building.
- Immediately call your gas supplier from a neighbor's phone. Follow the gas supplier's instructions.
- If you cannot reach your gas supplier, call the fire department.

*IMPORTANT:* Operating heater where impurities in air exist may create odors. Cleaning supplies, paint, paint remover, cigarette smoke, cements and glues, new carpet or textiles, etc., create fumes. These fumes may mix with combustion air and create odors. These odors will disappear over time.

OBSERVED PROBLEM	POSSIBLE CAUSE	REMEDY
Heater produces unwanted odors	<ol style="list-style-type: none"><li>1. Heater burning vapors from paint, hair spray, glues, cleaners, chemicals, new carpet, etc. (See <i>IMPORTANT</i> statement above)</li><li>2. Gas leak. See <b>Warning statement at top of page</b></li></ol>	<ol style="list-style-type: none"><li>1. Open window and ventilate room. Stop using odor causing products while heater is running</li><li>2. Locate and correct all leaks (see <i>Checking Gas Connections</i>, page 15)</li></ol>
Heater shuts off in use (ODS operates)	<ol style="list-style-type: none"><li>1. Not enough fresh air is available</li><li>2. Low line pressure</li><li>3. ODS/pilot is partially clogged</li></ol>	<ol style="list-style-type: none"><li>1. Open window and/or door for ventilation</li><li>2. Contact local natural or propane/LP gas company</li><li>3. Clean ODS/pilot (see <i>Cleaning and Maintenance</i>, page 23)</li></ol>
Gas odor even when control knob is in OFF position	<ol style="list-style-type: none"><li>1. Gas leak. See <b>Warning statement at top of page</b></li><li>2. Control valve defective</li></ol>	<ol style="list-style-type: none"><li>1. Locate and correct all leaks (see <i>Checking Gas Connections</i>, page 15)</li><li>2. Replace control valve</li></ol>
Gas odor during combustion	<ol style="list-style-type: none"><li>1. Foreign matter between control valve and burner</li><li>2. Gas leak. See <b>Warning statement at top of page</b></li></ol>	<ol style="list-style-type: none"><li>1. Take apart gas tubing and remove foreign matter</li><li>2. Locate and correct all leaks (see <i>Checking Gas Connections</i>, page 15)</li></ol>

## SPECIFICATIONS

### FVFM27NR AND VYM27NR

- Rating (Variable): 20,000/39,000 Btu/Hr
- Gas Type: Natural Gas
- Ignition: Piezo
- Manifold Pressure: 3.5" W.C.
- Inlet Gas Pressure (in. of water):  
Maximum - 10.5" W.C., Minimum\* - 5" W.C.
- Shipping Weight: 32 lbs.

### FVFM27PR AND VYM27PR

- Rating (Variable): 20,000/39,000 Btu/Hr
- Gas Type: Propane/LP
- Ignition: Piezo
- Manifold Pressure: 8.0" W.C.
- Inlet Gas Pressure (in. of water):  
Maximum - 14" W.C., Minimum\* - 11" W.C.
- Shipping Weight: 32 lbs.
- \* For input adjustment

## REPLACEMENT PARTS

*Note: Use only original replacement parts. This will protect your warranty coverage for parts replaced under warranty.*

Contact authorized dealers of this product. If they can't supply original replacement part(s), call FMI PRODUCTS, LLC at 1-866-328-4537.

When calling, have ready:

- your name
- your address
- model and serial numbers of your heater
- how heater was malfunctioning
- purchase date

Usually, we will ask you to return the part to the factory.

## SERVICE HINTS

### When Gas Pressure Is Too Low

- pilot will not stay lit
- burners will have delayed ignition
- heater will not produce specified heat
- propane/LP gas supply may be low

You may feel your gas pressure is too low. If so, contact your local natural or propane/LP gas supplier.

## TECHNICAL SERVICES

You may have further questions about installation, operation, or troubleshooting. If so, contact FMI PRODUCTS, LLC at 1-866-328-4537. When calling please have your model and serial numbers of your heater ready.

You can also visit FMI PRODUCTS, LLC's web site at [www.fmiproducts.com](http://www.fmiproducts.com).

## ACCESSORIES

Purchase these accessories from your local dealer. If they can not supply these accessories call FMI PRODUCTS, LLC at 1-866-328-4537 for information. You can also write to the address listed on the back page of this manual.

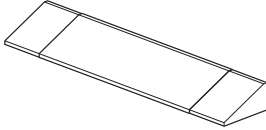

### FIREPLACE HOOD

**Black - GA6050**

**Antique Brass - GA6053**

Helps deflect heat away from mantel or wall above fireplace. Fits opening 28" to 4" wide.

### DAMPER CLAMP - GA6080

Permanently opens chimney flue damper for vented operation. Can be used only with non-thermostat accessories.

### FIRE CRACKLE - CF6-A

Creates the sound of a real burning fire.

### LAVA ROCK - GA6060

Order when additional rock is desired. (3 lb. bag)



### RECEIVER AND HAND-HELD THERMOSTAT REMOTE CONTROL KIT - TLCR

Allows the fireplace to be operated in a manually or thermostatically controlled mode. You can turn the fireplace on and off without ever leaving the comfort of your easy chair.



### RECEIVER AND HAND-HELD REMOTE CONTROL KIT - MLCR

Allows the fireplace to be turned on and off by using a hand-held remote control.

### WALL-MOUNT THERMOSTAT SWITCH - GWMT1

The desired comfort setting can be selected on the wall thermostat and the log heater will automatically cycle from pilot to the heat setting selected.

### WALL-MOUNT ON/OFF SWITCH GWMS2

Allows the gas log heater to be turned on and off with a wall switch

# PARTS

## MODELS

FVFM27NR, FVFM27PR, VYM27NR AND VYM27PR,

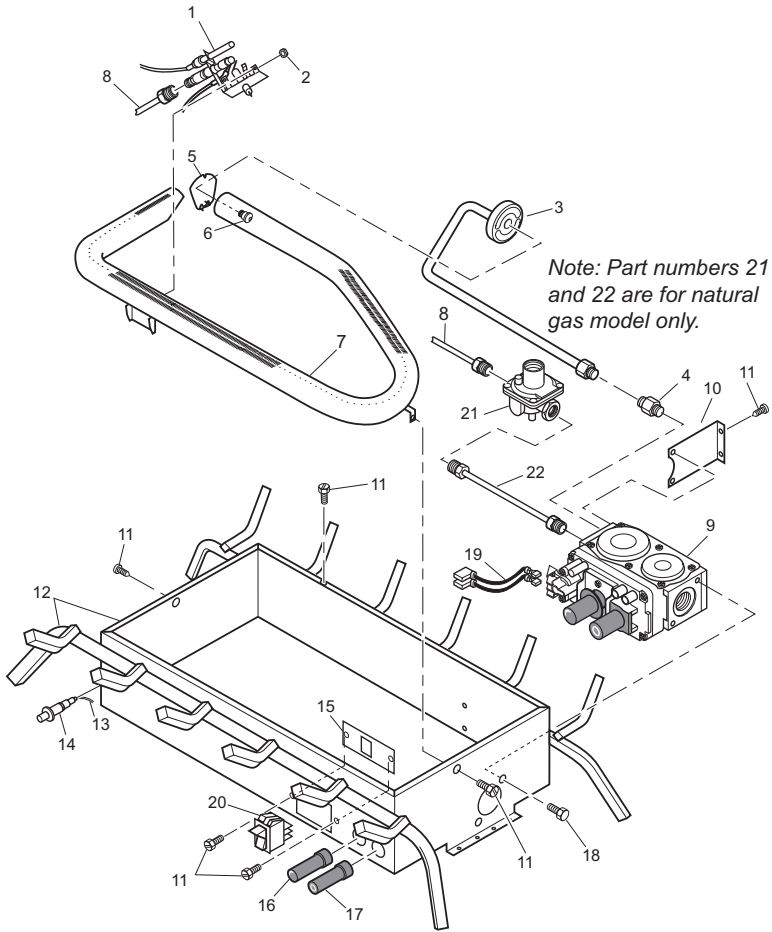

## PARTS LIST

This list contains replaceable parts used in your heater. When ordering parts, follow the instructions listed under Replacement Parts on page 28 of this manual.

KEY NO.	PART NO.	DESCRIPTION					QTY.
			FVFM27NR	FVFM27PR	VYM27NR	VYM27PR	
1	103779-01	ODS Pilot	•	•	•	•	1
	103778-01	ODS Pilot	•	•	•	•	1
2	098249-01	ODS Nut	•	•	•	•	2
3	104592-03	Burner Outlet Tube	•	•	•	•	1
4	098264-02	Male Connector	•	•	•	•	1
5	111124-01	Burner Retainer Spring	•	•	•	•	1
6	099056-16	Burner Orifice Injector	•	•	•	•	1
	099056-17	Burner Orifice Injector	•	•	•	•	1
7	122294-01	Burner	•	•	•	•	1
8	100609-01	Pilot Tube (Regulator to Pilot)	•	•	•	•	1
	099387-13	Pilot Tube (Regulator to Pilot)	•	•	•	•	1
9	103781-01	Gas Control Valve	•	•	•	•	1
	103781-02	Gas Control Valve	•	•	•	•	1
10	104611-01	Lower Bracket	•	•	•	•	1
11	098304-01	Screw, #8 x 0.38	•	•	•	•	7
12	**	Painted Base Assembly	•	•	•	•	1
13	098271-10	Ignitor Cable	•	•	•	•	1
14	102445-01	Piezo Ignitor	•	•	•	•	1
15	103587-02	Plate, Switch	•	•	•	•	1
16	103784-02	Flame Adjustment Knob	•	•	•	•	1
17	103784-01	Off-Pilot-On Knob	•	•	•	•	1
18	M12461-26	Screw, Hex Slr Wsr 10-32 x 0.38	•	•	•	•	4
19	103284-02	Wiring Harness	•	•	•	•	1
20	099998-01	Switch	•	•	•	•	1
21	099918-02	Pilot Regulator	•	•	•	•	1
22	099387-15	Pilot Tube (Valve to Regulator)	•	•	•	•	1
<b>PARTS AVAILABLE — NOT SHOWN</b>							
	100563-01	Warning Plate	•	•	•	•	1
	103877-01	Lighting Instructions Plate	•	•	•	•	1
	100639-01	Caution Decal	•	•	•	•	1
	101137-02	Hardware Kit	•	•	•	•	1
	GA6060	Lava Rock	•	•	•	•	2
	120466-01	Flexline and Fitting	•	•	•	•	1

\*\*Not a field replaceable part.

## PARTS

### MODELS

FVFM27NR, FVFM27PR, VYM27NR AND VYM27PR

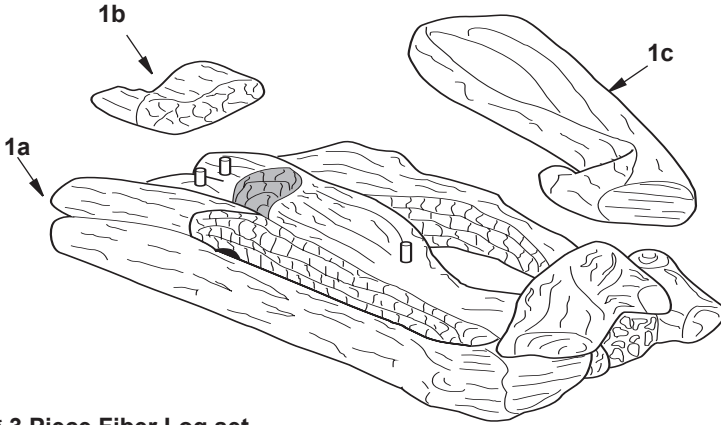

\* 3 Piece Fiber Log set

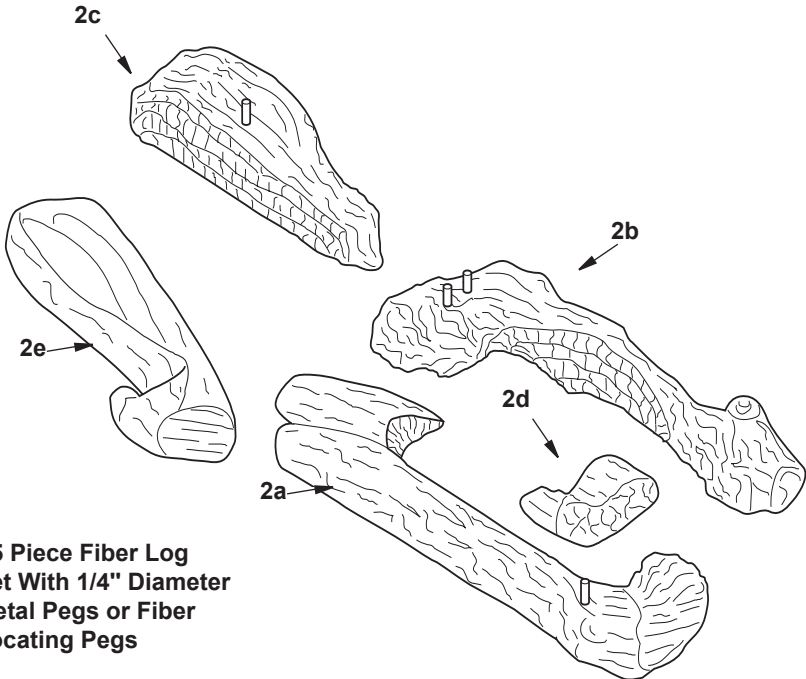

\* 5 Piece Fiber Log Set With 1/4" Diameter Metal Pegs or Fiber Locating Pegs



## PARTS LIST

This list contains replaceable parts used in your heater. When ordering parts, follow the instructions listed under Replacement Parts on page 28 of this manual.

### 3 PIECE FIBER LOGS

KEY NO.	PART NO.	DESCRIPTION			QTY.
			FVFM27NR	FVFM27PR	
1	104676-01	Log, Multi-Sided	•	•	1
1a	105060-01	Bottom Log (#1)	•	•	1
1b	105064-01	Log Piece (#3)	•	•	1
1c	105062-01	Top Log (#2)	•	•	1

### 5 PIECE FIBER LOGS WITH FIBER LOCATING PEGS

KEY NO.	PART NO.	DESCRIPTION					QTY.
			FVFM27NR	FVFM27PR	VYM27NR	VYM27PR	
2	122582-01	Log, 5-piece Multi-Sided	•	•	•	•	1
2a	122583-01	Front Log (#1)	•	•	•	•	1
2b	122583-02	Rear Log (#2)	•	•	•	•	1
2c	122583-03	Center Insert Log (#3)	•	•	•	•	1
2d	122583-04	Top Left Log (#4)	•	•	•	•	1
2e	122583-05	Top Right Log (#5)	•	•	•	•	1

### 5 PIECE FIBER LOGS WITH 1/4" METAL PEGS

KEY NO.	PART NO.	DESCRIPTION					QTY.
			FVFM27NR	FVFM27PR	VYM27NR	VYM27PR	
2	110397-06	Log, 5-piece Multi-Sided	•	•	•	•	1
2a	110321-01	Front Log (#1)	•	•	•	•	1
2b	110321-02	Rear Log (#2)	•	•	•	•	1
2c	110321-03	Top Center Log (#3)	•	•	•	•	1
2d	110321-04	Top Left Log (#4)	•	•	•	•	1
2e	110321-05	Top Right Log (#5)	•	•	•	•	1





# WARRANTY

## KEEP THIS WARRANTY

Model (located on product or identification tag) \_\_\_\_\_

Serial No. (located on product or identification tag) \_\_\_\_\_

Date Purchased \_\_\_\_\_

Keep receipt for warranty verification.

## FMI PRODUCTS, LLC LIMITED WARRANTIES

### New Products

**Standard Warranty:** FMI PRODUCTS, LLC warrants this new product and any parts thereof to be free from defects in material and workmanship for a period of four (4) years from the date of first purchase from an authorized dealer provided the product has been installed, maintained and operated in accordance with FMI PRODUCTS, LLC's warnings and instructions.

For products purchased for commercial, industrial or rental usage, this warranty is limited to 90 days from the date of first purchase.

### Factory Reconditioned Products

**Limited Warranty:** FMI PRODUCTS, LLC warrants factory reconditioned products and any parts thereof to be free from defects in material and workmanship for 30 days from the date of first purchase from an authorized dealer provided the product has been installed, maintained and operated in accordance with FMI PRODUCTS, LLC's warnings and instructions.

### Terms Common to All Warranties

The following terms apply to all of the above warranties:

Always specify model number and serial number when contacting the manufacturer. To make a claim under this warranty the bill of sale or other proof of purchase must be presented.

This warranty is extended only to the original retail purchaser when purchased from an authorized dealer, and only when installed by a qualified installer in accordance with all local codes and instructions furnished with this product.

This warranty covers the cost of part(s) required to restore this product to proper operating condition and an allowance for labor when provided by a FMI PRODUCTS, LLC Authorized Service Center or a provider approved by FMI PRODUCTS, LLC. Warranty parts must be obtained through authorized dealers of this product and/or FMI PRODUCTS, LLC who will provide original factory replacement parts. Failure to use original factory replacement parts voids this warranty.

Travel, handling, transportation, diagnostic, material, labor and incidental costs associated with warranty repairs, unless expressly covered by this warranty, are not reimbursable under this warranty and are the responsibility of the owner.

Excluded from this warranty are products or parts that fail or become damaged due to misuse, accidents, improper installation, lack of proper maintenance, tampering, or alteration(s).

This is FMI PRODUCTS, LLC's exclusive warranty, and to the full extent allowed by law; this express warranty excludes any and all other warranties, express or implied, written or verbal and limits the duration of any and all implied warranties, including warranties of merchantability and fitness for a particular purpose to four (4) years on new products and 30 days on factory reconditioned products from the date of first purchase. FMI PRODUCTS, LLC makes no other warranties regarding this product.

FMI PRODUCTS, LLC's liability is limited to the purchase price of the product, and FMI PRODUCTS, LLC shall not be liable for any other damages whatsoever under any circumstances including indirect, incidental, or consequential damages.

Some states do not allow limitations on how long an implied warranty lasts or the exclusion or limitation of incidental or consequential damages, so the above limitation or exclusion may not apply to you.

This warranty gives you specific legal rights, and you may also have other rights which vary from state to state.

For information about this warranty contact:

  
**FMI PRODUCTS, LLC**  
2701 S. Harbor Blvd.  
Santa Ana, CA 92704  
1-866-328-4537  
[www.fmiproducts.com](http://www.fmiproducts.com)

121353-01  
Rev. H  
02/10

## Free Manuals Download Website

<http://myh66.com>

<http://usermanuals.us>

<http://www.somanuals.com>

<http://www.4manuals.cc>

<http://www.manual-lib.com>

<http://www.404manual.com>

<http://www.luxmanual.com>

<http://aubethermostatmanual.com>

Golf course search by state

<http://golfingnear.com>

Email search by domain

<http://emailbydomain.com>

Auto manuals search

<http://auto.somanuals.com>

TV manuals search

<http://tv.somanuals.com>