

Flowtron Mosquito PowerTrap®

Operating Instructions



DOMESTIC
REG. NO. 28457 PCPA



IMPORTANT



KEEP OUT OF REACH OF CHILDREN.
READ THE LABEL AND OPERATING
INSTRUCTIONS BEFORE USING.

Please retain operating instructions for
future reference.

Table of Contents

	Page
Carton Contents	2
Your Enemy – the Mosquito	3
How Your Mosquito PowerTrap Works	3
Rules for Safe Use	4
Placement	4
Installation	5
Operation	6
Maintenance	7
Troubleshooting Chart	8
Accessories	8

Carton Contents

Qty.	Description
1	Mosquito PowerTrap
1	Power Pack and Wire
1	Catch Tray
1	Octenol Cartridge
1	Post
1	Tank Support Strap *
1	Tank Stand Assembly
1	Tank Wrap
1	Tank Cap
1	Tank Strap **
1	Owners Manual

* MT-200 series only

** MT-300 series only

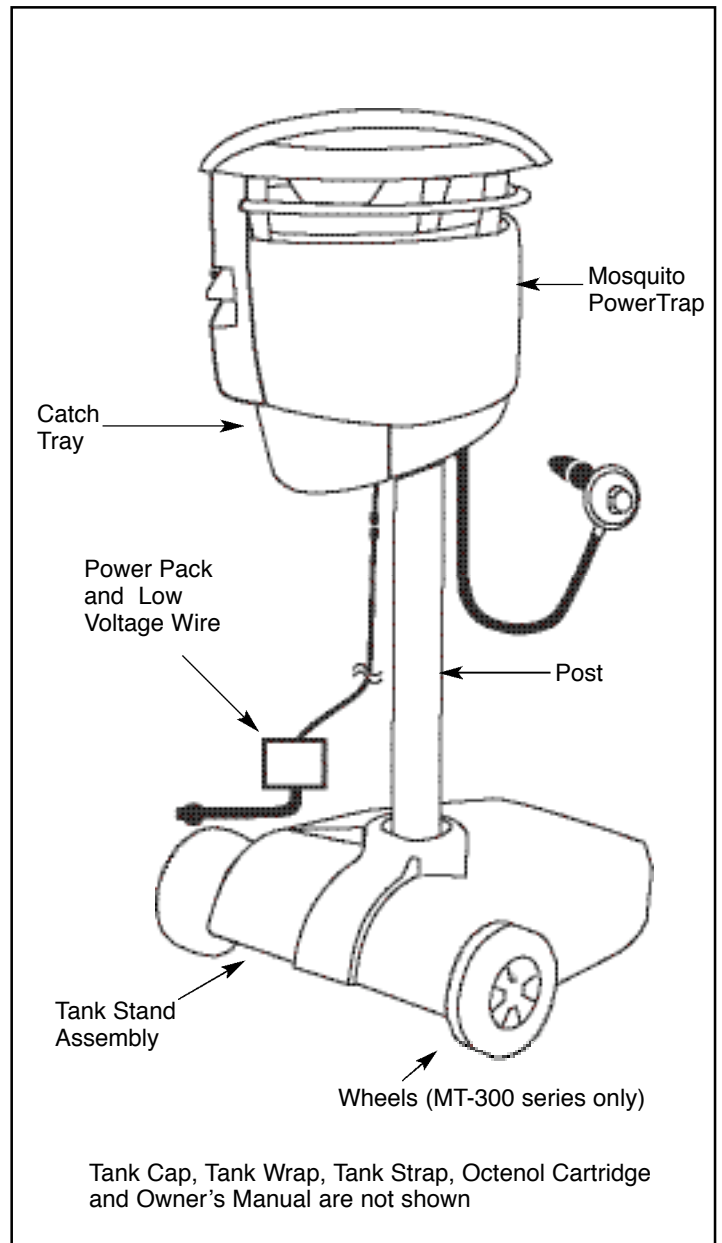

Unpacking Instructions

Your Mosquito PowerTrap has been carefully packed at the factory to prevent damage during shipment. Carefully open the carton and:

1. Remove contents from carton.
2. Check parts against carton content list.

Your Enemy – the Mosquito

There are some 2,700 species (different kinds of mosquitoes) in the world with about 170 species in North America alone.

Most mosquitoes live and die close to where they hatch, although some can travel miles (kilometres) in search of a host. Only the female mosquito bites as she requires a blood meal to produce eggs.

Mosquitoes require standing water in aquatic habitats including fresh water, salt water marshes, brackish water or in water found in containers, old tires, tree holes, even flower pots. The female mosquito lays her eggs on the surface of the water and if conditions are right the eggs hatch and become larvae, then pupae and finally adult mosquitoes; all in 10 to 14 days.

Both male and female mosquitoes feed regularly on nectar obtained from flowers, but females require blood to produce fertile eggs. Therefore, she must find a human or animal host to blood feed before she can lay her eggs.

Most mosquitoes that emerge in the wild never come in contact with humans but obtain blood from birds and other animals. Mosquito species that breed around the home remain close to where they hatched and are regarded as pests and carriers of disease.

Mosquitoes in search of a blood meal use visual, thermal and olfactory (odour) stimuli to locate a host. Of these, olfactory cues are the most important.

Out of the more than 100 compounds detected in human breath only two have been isolated and identified as significant mosquito attractants; **carbon dioxide** (CO₂) and **octenol** (1-OCTEN-3-OL). These attractants serve as long-range airborne attractants and can be detected by mosquitoes at distances of 100 feet to 125 feet (30 - 40 m).

At close range, body heat, moisture and lactic acid serve as terminal attractants. Certain species show strong preferences for biting different parts of the human body. This is thought to be related to local skin temperature and lactic acid output.

The attractiveness of different persons to mosquitoes varies substantially. Men are bitten more readily than women, adults more often than children and larger persons attract more mosquitoes perhaps because of their greater relative heat and carbon dioxide output.

How Your Flowtron Mosquito PowerTrap Works

The revolutionary new Flowtron Mosquito PowerTrap replicates the attractants mosquitoes use to locate, bite and annoy humans. It does this by producing carbon dioxide, heat and moisture and combining these stimuli with octenol to create an attractant to mosquitoes.

Your Flowtron Mosquito PowerTrap:

- Replicates the human attractants of respiration, odor and body heat.
- Converts readily available propane gas into heat, moisture and carbon dioxide, the acknowledged leading mosquito and attractants emitted by humans.
- Special super bright LED motion lighting provides added lure.
- Produces a powerful vacuum to draw mosquitoes into a convenient, removable catch tray where they quickly dehydrate and die for safe, clean disposal.
- Contains state-of-the-art computer controlled electronics to operate automatically in one of four modes selected by you.

Mosquito PowerTrap does away with ultraviolet lights and high voltage killing grids. Most importantly, it kills only female mosquitoes.

Flowtron Mosquito PowerTrap uses an exclusive platinum catalyst that converts air and propane gas into heat, moisture and carbon dioxide. It does this in an efficient, effective and economical manner. The catalyst converter is completely safe, flameless and **never needs to be replaced**.



Rules for Safe Use



1. Use outdoors only. Install the unit a minimum of 10 feet (3 m) from buildings and other structures.
2. Never place fingers or insert any object into the unit while it is operating.
3. Always disconnect unit from its power source and wait for unit to cool before handling, moving or servicing.
4. This device was designed for use with propane gas. Never attempt to use any other fuel, including liquid fuels or natural gas. Fire or damage to your Flowtron PowerTrap could result.
5. Always operate the unit in an upright position to prevent damage to the CO₂ generator.
6. Do not abuse the power pack. Never carry the power pack by its cord or yank it to disconnect it from a receptacle. Keep power cord away from heat, oil and sharp edges.
7. Never connect the unit to a battery or other D.C. voltage. Such an attempt will damage your unit.
8. Store indoors when not in use. Remove propane tank from unit before storing and store tank outdoors in a well ventilated space.

Placement

Your Mosquito PowerTrap is site specific and placement is critical for successful results.

Your Flowtron Mosquito PowerTrap emits a plume of octenol-enhanced carbon dioxide which mosquitoes follow in their search for a blood meal. Mosquitoes fly up-wind toward the source of the plume in their attempt to locate a host. Since the direction of the plume is dependent upon the direction of the wind, your unit should be positioned so it's attractant outlet faces downwind.

Female mosquitoes also feed on moisture laden nectar and fruit juices when not in search of a blood meal. They are usually found in shade; around flowers, trees, bushes and other vegetation; and adjacent to standing water.

For best results locate your unit 20 to 40 feet (6 -12 m) away from areas of human activity in a location near (but not in) bushes, wooded areas, or adjacent to standing water (other than swimming pools). Select a location which will result in the carbon dioxide plume blowing toward the area where mosquitoes are likely to hide and emerge. **A proper location will ensure that mosquitoes encounter the plume and follow it up-wind to the Flowtron Mosquito PowerTrap before they detect the presence of humans.**

See Illustration 1.

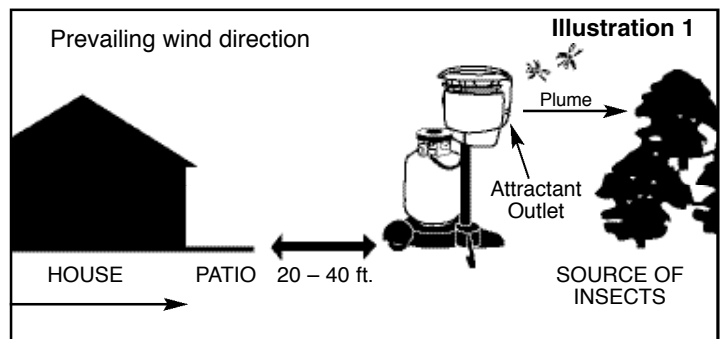

Assembly

Tank Stand (MT-200 series only)

1. Insert tank support strap into openings in tank stand as shown. **See Figure A.**
2. On the underside of the tank stand, loosen the two hex nuts located on the screws which extend from the sides of the base plate. Place the slots at the ends of the tank support strap over the screws and secure by tightening the two nuts. **See Figure B.**

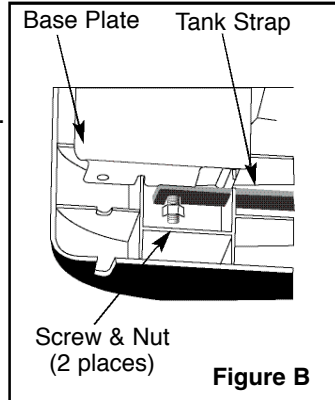
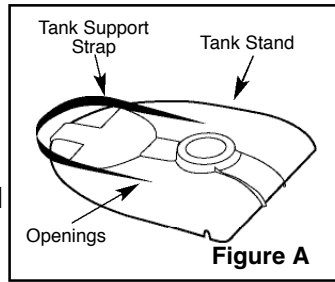

PowerTrap (MT-200 & MT-300 series)

1. Insert one end of the post into the post opening at the front of the tank stand. Insert opposite end of post into the post opening located at the bottom of the Flowtron Mosquito PowerTrap®. Align unit in relation to the tank stand. **See Illustration 2.**

Place a 20 lb. tank on the tank stand and install tank wrap around the tank.

2. Install catch tray by first inserting the rear of the tray into the housing. Then push in upper part of the latch and raise front of catch tray into place. **See Illustration 3.**

3. Position and screw power pack to either an outside or inside wall adjacent to a electrical outlet (screws not provided). Run the low voltage wire either above or below ground from the power pack to the unit. plug the low voltage wire into the power cord connector located at the bottom of the Flowtron Mosquito PowerTrap®. Plug the power pack into the electrical outlet.

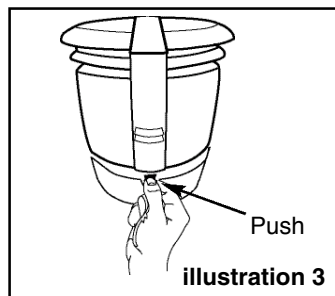
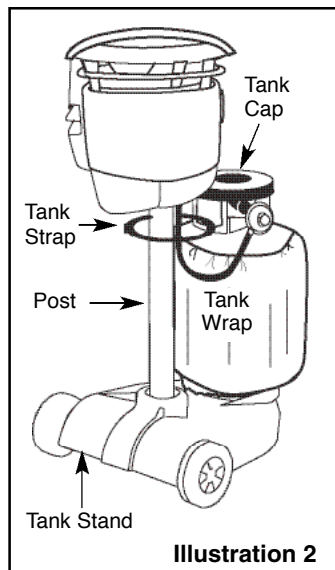

Connect Propane Regulator

1. Remove the plastic dust cover from your propane tank valve.
2. Screw the propane regulator coupling located on the end of the propane hose onto the tank valve by turning the black threaded coupling clockwise until tight. Hand tighten only. See Illustration 4.

Note: Gas will not flow unless connection is tight. **Tighten by hand only. Using a wrench or other tool could damage the regulator coupling and could cause a gas leak.**

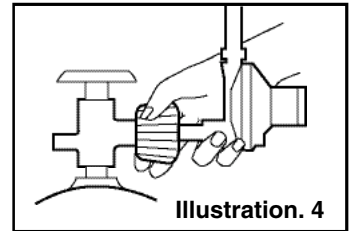

WARNING
Check for gas leaks by wetting the connections with a solution of soap and water and watching for bubbles. If bubbles form or if a bubble grows larger, there is a leak and connection must be tightened.

WARNING
Check for gas leaks every time you disconnect and reconnect a gas fitting.
Be sure there are no sparks or open flame in the area when you check for leaks.
Do not use a liquid propane tank with a damaged valve. Have dented or rusty propane tanks checked by your propane supplier.
Only use regulator supplied with your Flowtron PowerTrap.

3. Place tank cap on top of tank.

4. **(MT-300 series only)** Move your unit to the desired location in your yard. Remove catch tray and grasp housing as shown. See trap "Placement" instructions on pg. 4.

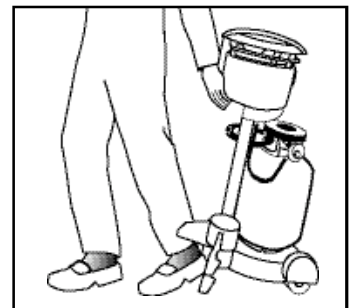

Operation

Your Mosquito PowerTrap is fully automatic. It is equipped with a photocell, temperature sensors and a computer microprocessor.

The control panel is located on the top of the unit and has the following operating modes:

- 24/7 (on 24 hours, 7 days/week)
- 3 Hours (on at dusk, off 3 hours later)
- 3 + 2 Hours (on at dusk, off 3 hours later; on again at dawn, off 2 hours later).
- 4 + 3 Hours (on at dusk, off 4 hours later; on again at dawn, off 3 hours later)
- Off/Reset (manual off)

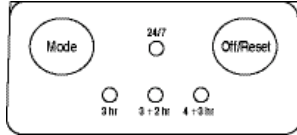

To select the desired mode, first push the button labeled "Off/Reset" to clear the computer memory. Then push the button labeled "Mode".

For continuous operation press the "Mode" button once. The green light labeled "24/7" will light and the unit will operate continuously 24 hours per day until the "Off/Reset" button is pressed.

For timed operation, press and hold the "Mode" button. When the desired mode is selected as indicated by its green light, release the button. No further control is necessary and your unit will function in the mode selected every day until the "Off/Reset" button is depressed or an interruption occurs in the electrical power source.

Note:

To resume operation following an electrical disturbance or a loss of electrical power, press the "Off/Reset" button to clear the computer memory then reset the unit to the desired operating mode.

In the event the Flowtron PowerTrap fails to respond to its controls (mode selection) unplug the unit for a few seconds, reattach plug and then reset to the desired mode.

When the 24/7 mode is selected, the unit will begin its start cycle and approximately three minutes later, the fan and LED lights located in the entrance to the trap will come on intermittently. Once the catalyst

has reached operating temperature, which will take five to ten minutes, the fan and LED lights will remain on and the start cycle will be complete.

When a timed mode is selected, the fan and LED lights will come on immediately and remain on. The unit, however, waits for dusk and then checks the outside air temperature to determine if it is sufficiently warm for insect activity i.e. above 55° – 60°F (13° - 15°C). This is an important feature to conserve propane fuel. The unit will automatically begin its start cycle when the light level reaches dusk and remains at the level of dusk for ten minutes (thus avoiding the effects of transient light sources) and if the outside air temperature is above the 55° – 60°F (13° - 15°C) range.

The start cycle is also repeated at dawn when the 3 + 2 hr or the 4 + 3 hr mode is selected.

During start cycles, which are from five to ten minutes in duration, the fan and LED lights operate intermittently.

Ten to fifteen minutes after the unit detects a lack of propane fuel (either due to an empty tank or due to improper installation of the propane regulator to the tank valve) the three green timed mode lights on the control panel will flash. Simply switch the PowerTrap off and refuel. If the unit is not out of propane and the lights are flashing check that the tank valve is fully open and that the regulator is properly attached to the tank valve.

Mosquitoes are generally most active shortly after dusk and again at dawn. Therefore, the 3 + 2, or 4 + 3 timed modes are usually the most economical settings.

The 24/7 mode is desirable if day flying mosquitoes are present or to operate at temperatures below 55° F (13°C).

Note:

As mosquitoes pass through the fan, most are killed and thrown against the side of the internal screen-lined funnel. Those that escape the fan's killing action end up in the catch tray where they quickly dehydrate and die. See page 7 for instructions for removing the screen-lined funnel and cleaning the screen.

Octenol Cartridge

U.S. Government and university researchers have demonstrated that **octenol** combined with **carbon dioxide** (both components of respiration) are irresistible attractants to mosquitoes.

The Flowtron Mosquito PowerTrap uses a specially designed time release cartridge containing **octenol** (1-OCTEN-3-OL).

To Install the Octenol Cartridge:

1. Remove the octenol cartridge from the sealed pouch and peel the protective cover from the face of the cartridge. Avoid touching the openings in the cartridge and always wash hands thoroughly after contact.
2. Place the cartridge in the rectangle slot located at the bottom of the plenum. Insert the cartridge with the openings facing inward. See Illustration 5.

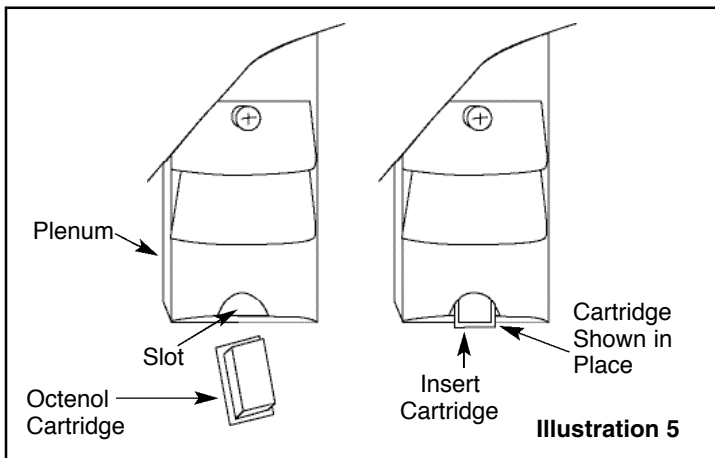

Maintenance

1. Refill your propane tank as required. The green timed mode lights on the control panel will flash when a new supply of propane is needed.
2. Replace the octenol cartridge after 450 hours of operation.

NOTE: The following table may be used as a general guide to determine approximate propane refill times.

Operating Mode Hours per Day	Refill Times (20 lb propane tank)
3 . . . hours	6 – 7 months
3 + 2 . . . hours	3 – 4 months
4 + 3 . . . hours	2 – 3 months
24 hours	3 – 4 weeks

3. Empty the catch tray periodically to ensure proper air flow through the trap. To remove the catch tray push in on the latch at the front of the catch tray and pull tray down.
4. Remove and clean the screen-lined funnel each time the propane tank is refilled or more often during periods of heavy infestation. To remove funnel, proceed as follows:

Switch unit off and allow it to cool. Remove catch tray.

Push rear of bottom funnel ring up into the unit's housing until front tabs become disengaged from housing. See figure A.

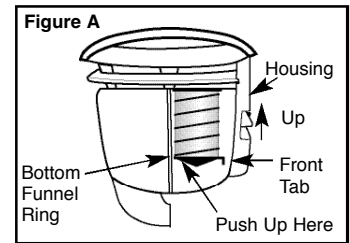

Pull funnel down and forward releasing rear section of upper funnel ring and remove funnel from unit. See figure B.

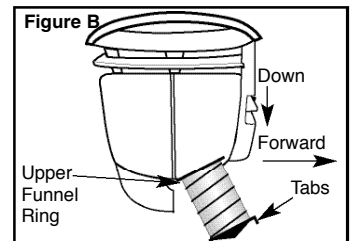

Remove insect debris from screen surrounding funnel. Wash screen with water and shake off excess water before re-installing.

Re-install funnel by holding funnel at a slight angle and insert the front edge of the upper funnel ring inside of unit's housing. See figure C.

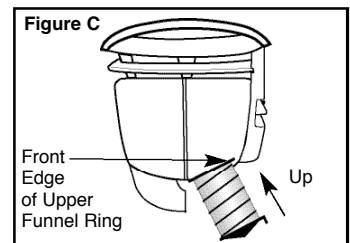

Push funnel upwards and with the rear section of the bottom funnel ring at a slight angle compress funnel until front tabs of bottom funnel ring are up inside of the housing. See figure D.

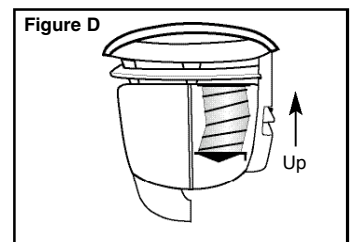

Release funnel and it will spring into place.

Replace catch tray and re-start unit.

WARRANTY

Flowtron warrants your Mosquito PowerTrap to be free from defects in materials or workmanship under normal use and service for one year from date of original purchase. All parts which are defective will be replaced free of charge. Any implied warranties, including the implied warranty of merchantability are also limited in duration to the one year period from the original purchase date.

The provisions of this warranty shall not apply to any product which as been subject to misuse, neglect or accident, nor which is used for a purpose for which it is not designed, or which shall have been repaired or altered in any way so as to adversely affect its performance and reliability. Service by unauthorized parties voids your warranty. Warranty covers only the original purchaser. Commercial and/or professional use is excluded from warranty coverage.

Flowtron neither assumes nor authorizes any person to assume for it any other liability in connection with its product. No responsibility is assumed for any consequential damages that may result from the use of a Flowtron product, nor for damages due to accident, abuse, lack of responsible care, the affixing of any unauthorized attachment, loss of parts or subjecting this unit to any but the specified voltage.

If the unit fails to operate during the warranty period, send the product, along with purchase receipt showing purchase date and description of the problem to: Flowtron Service Center, 15 Highland Avenue, Malden, MA 02148. Transportation costs for returning any defective product are the responsibility of the consumer.

This warranty gives you specific legal rights, and you may also have other rights which vary from state to state.

Flowtron Outdoor Products, 15 Highland Ave, Malden, MA 02148
1-800-343-3280

Trouble Shooting Chart

Symptom	Probable Cause	Remedy
Mode lights on control panel do not light when "MODE" switch is depressed.	No power at outlet	Check for electrical power at outlet.
	Unit not properly connected to its power pack.	Check plug connections between unit and power pack low voltage cord.
Green lights on control panel are flashing.	Lack of propane.	Refill propane tank.
	Propane tank valve closed.	Open tank valve.
	Regulator coupling not properly attached.	Check propane regulator coupling for proper engagement and/or leaks.
The fan does not run continuously after the unit has been on for at least 10 minutes.	Lack of propane	Same as for "green lights flashing".
	Start cycle malfunction.	Press " Reset " and restart in 24/7 mode.
The unit does not start up at dusk when in an automatic mode.	Unit has not sensed dusk or night for a full 10 minutes.	Wait for 10 minutes of darkness.
	Ambient temperature is below 55-60°F.	Unit will start automatically if temperature rises above 55° F within 2 hours of dusk.
	Ambient light level is too high.	Shield unit from extraneous light.
Not catching mosquitoes when the fan is running, the valve is pulsing and the green lights on the control panel are not flashing.	Funnel end is not over catch tray nozzle opening.	Engage the funnel end with the catch tray nozzle opening.
	Funnel clogged with insect debris.	Clean funnel. See page 7.
	Trap is not located in a productive site.	Move trap to a new site. See placement guidelines in the owner's manual.
	Windy, cool or stormy weather.	Wait for conditions more to the mosquito's liking.
	Current mosquito population not readily attracted to CO ₂ + Octenol.	Notably the day flying Asian tiger Mosquito. Operate the trap with the octenol cartridge removed.

Any problems you encounter that are not corrected by the action recommended in this chart should be referred to the Flowtron Service Department • (800) 343-3280

Accessories

Accessories are available at your local retail outlet or on-line at www.flowtron.com



**Mosquito Attractant:
Octenol Cartridge – MA 1000**
Makes your Mosquito PowerTrap more effective in attracting mosquitoes and biting flies.



Extension Cord – EC-50
50 foot low voltage extension cord. Allows placement of the Mosquito PowerTrap an additional 50 feet away from the power source.

Free Manuals Download Website

<http://myh66.com>

<http://usermanuals.us>

<http://www.somanuals.com>

<http://www.4manuals.cc>

<http://www.manual-lib.com>

<http://www.404manual.com>

<http://www.luxmanual.com>

<http://aubethermostatmanual.com>

Golf course search by state

<http://golfingnear.com>

Email search by domain

<http://emailbydomain.com>

Auto manuals search

<http://auto.somanuals.com>

TV manuals search

<http://tv.somanuals.com>