

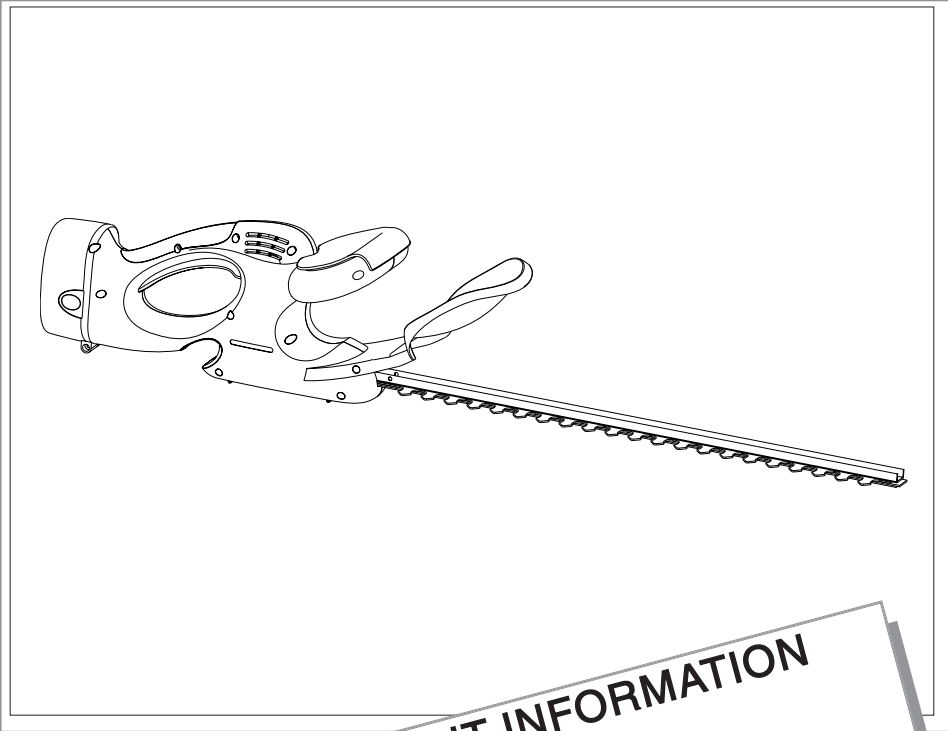

# EASICUT 500CT



Original Instructions



**IMPORTANT INFORMATION**  
Read before use  
& retain for future reference

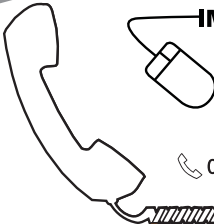

**IMPORTANT** Please register your product warranty on line.

To register your warranty and for all your parts requirements please visit [www.flymo.com](http://www.flymo.com)

For all other enquiries

☎ 0844 844 4558 **UK** 1800 882 350 **ROI**

✉ [customer.services@husqvarna.co.uk](mailto:customer.services@husqvarna.co.uk)

## Carton Contents

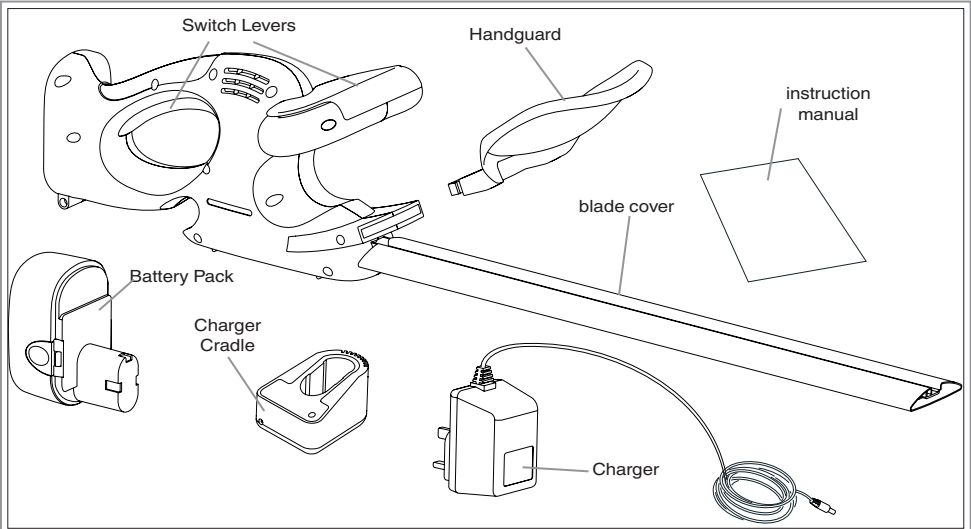

### IMPORTANT!

Please check the contents of the carton are correct **BEFORE** assembling your new product.

### IF ANY PARTS ARE MISSING CONTACT:-

Husqvarna UK Ltd. Customer Service Department direct

Telephone : 0844 844 4558 **UK**

1800 882 350 **ROI**

Fax : 01325 302530

## Safety



If not used properly this product can be dangerous! This product can cause serious injury to the operator and others, the warnings and safety instructions must be followed to ensure reasonable safety and efficiency in using this product. The operator is responsible for following the warning and safety instructions in this manual and on the product.

### Explanation of Symbols on your product



Warning.



Read the user instructions carefully to make sure you understand all the controls and what they do.



Do not use in the rain or leave the product outdoors while raining.



The use of eye protection is recommended.

### General Power Tool Safety Warnings

**WARNING** Read all safety warnings and all instructions. Failure to follow the warnings and instructions may result in electric shock, fire and/or serious injury. Save all warnings and instructions for future reference. The term "power tool" in the warnings refers to your mains-operated (corded) power tool or battery-operated (cordless) power tool.

1) **Work area safety**

- a) **Keep work area clean and well lit.** Cluttered or dark areas invite accidents.
- b) **Do not operate power tools in explosive atmospheres, such as in the presence of flammable liquids, gases or dust.** Power tools create sparks which may ignite the dust or fumes.
- c) **Keep children and bystanders away while operating a power tool.** Distractions can cause you to lose control.

### 2) Electrical safety

- a) **Power tool plugs must match the outlet. Never modify the plug in any way. Do not use any adaptor plugs with earthed (grounded) power tools.** Unmodified plugs and matching outlets will reduce risk of electric shock.
- b) **Avoid body contact with earthed or grounded surfaces, such as pipes, radiators, ranges and refrigerators.** There is an increased risk of electric shock if your body is earthed or grounded.
- c) **Do not expose power tools to rain or wet conditions.** Water entering a power tool will increase the risk of electric shock.
- d) **Do not abuse the cord. Never use the cord for carrying, pulling or unplugging the power tool. Keep cord away from heat, oil, sharp edges or moving parts.** Damaged or entangled cords increase the risk of electric shock.

- e) **When operating a power tool outdoors, use an extension cord suitable for outdoor use.** *Use of a cord suitable for outdoor use reduces the risk of electric shock.*
- f) **If operating a power tool in a damp location is unavoidable, use a residual current device (RCD) protected supply.** *Use of an RCD reduces the risk of electric shock.*
- 3) **Personal safety**
- a) **Stay alert, watch what you are doing and use common sense when operating a power tool. Do not use a power tool while you are tired or under the influence of drugs, alcohol or medication.** *A moment of inattention while operating power tools may result in serious personal injury.*
- b) **Use personal protective equipment. Always wear eye protection.** *Protective equipment such as dust mask, non-skid safety shoes, hard hat, or hearing protection used for appropriate conditions will reduce personal injuries.*
- c) **Prevent unintentional starting. Ensure the switch is in the off-position before connecting to power source and/or battery pack, picking up or carrying the tool.** *Carrying power tools with your finger on the switch or energising power tools that have the switch on invites accidents.*
- d) **Remove any adjusting key or wrench before turning the power tool on.** *A wrench or a key left attached to a rotating part of the power tools may result in personal injury.*
- e) **Do not overreach. Keep proper footing and balance at all times.** *This enables better control of the power tool in unexpected situations.*
- f) **Dress properly. Do not wear loose clothing or jewellery. Keep your hair, clothing and gloves away from moving parts.** *Loose clothes, jewellery or long hair can be caught in moving parts.*
- g) **If devices are provided for the connection of dust extraction and collection facilities, ensure these are connected and properly used.** *Use of dust collection can reduce dust-related hazards.*
- 4) **Power tool use and care**
- a) **Do not force the power tool. Use the correct power tool for your application.** *The correct power tool will do the job better and safer at the rate for which it was designed.*
- b) **Do not use the power tool if the switch does not turn it on and off.** *Any power tool that cannot be controlled with the switch is dangerous and must be repaired.*
- c) **Disconnect the plug from the power source and/or the battery pack from the power tool before making any adjustments, changing accessories, or storing power tools.** *Such preventive safety measures reduce the risk of starting the power tool accidentally.*
- d) **Store idle power tools out of the reach of children and do not allow persons unfamiliar with the power tool or these instructions to operate the power tool.** *Power tools are dangerous in the hands of untrained users.*
- e) **Maintain power tools. Check for misalignment or binding of moving parts, breakage of parts and any other condition that may affect the power tool's operation. If damaged, have the power tool repaired before use.** *Many accidents are caused by poorly maintained power tools.*
- f) **Keep cutting tools sharp and clean.** *Properly maintained cutting tools with sharp cutting edges are less likely to bind and are easier to control.*
- g) **Use the power tool, accessories and tool bits etc. in accordance with these instructions, taking into account the working conditions and the work to be performed.** *Use of the power tool for operations different from those intended could result in a hazardous situation.*
- 5) **Battery tool use and care**
- a) **Recharge only with the charger specified by the manufacturer.** *A charger that is suitable for one type of batter pack may create a risk of fire when used with another battery pack.*
- b) **Use power tools only with specifically designated battery packs.** *Use of any other battery packs may create a risk of injury and fire.*
- c) **When battery pack is not in use, keep it away from other metal objects, like paper clips, coins, keys, nails, screws or other small metal objects, that can make a connection from one terminal to another.** *Shorting the battery terminals together may cause burns or a fire.*
- d) **Under abusive conditions, liquid may be ejected from the battery; avoid contact.** *If contact accidentally occurs, flush with water. If liquid contacts eyes, additionally seek medical help. Liquid ejected from the battery may cause irritation or burns.*
- 6) **Service**
- a) **Have your power tool serviced by a qualified repair person using only identical replacement parts.** *This will ensure that the safety of the power tool is maintained.*
- Hedge trimmer safety warnings:**
- **Keep all parts of the body away from the cutter blade.** *Do not remove cut material or hold material to be cut when blades are moving. Make sure the switch is off when clearing jammed material. A moment of inattention while operating the hedge trimmer may result in serious personal injury.*
  - **Carry the hedge trimmer by the handle with the cutter blade stopped.** *When transporting or storing the hedge trimmer always fit the cutting device cover. Proper handling of the hedge trimmer will reduce possible personal injury from the cutter blades.*
  - **Hold the power tool by insulated gripping surfaces only, because the cutter blade may contact hidden wiring.** *Cutter blades contacting a "live" wire may make exposed metal parts of the power tool "live" and could give the operator an electric shock.*
  - **Keep cable away from the cutting area.** *During operation the cable may be hidden in shrubs and can be accidentally cut by the blade.*
- Additional Safety Recommendations**
- Work area safety**
1. Never allow children or people unfamiliar with these instructions to use the product. Local regulations may restrict the age of the operator.
  2. Only use the product in the manner and for the functions described in these instructions.
  3. The operator or user is responsible for accidents or hazards occurring to other people or their property.
- Personal safety**
1. Always wear suitable clothing, gloves, and stout shoes.
  2. Thoroughly inspect the area where the product is to be used and remove all wires and other foreign objects.
  3. Before using the machine and after any impact, check for signs of wear or damage and repair as necessary.
  4. Always ensure the hand guard supplied is fitted before using the product. Never attempt to use an incomplete product or one with an unauthorised modification.
  5. This product has not been designed to provide protection from electric shock in the event of contact with overhead electric lines.

### Power tool use and care

1. Know how to stop the product quickly in an emergency.
2. Never hold the product by the guard.
3. Never operate the product with damaged guards or without guards in place.
4. Do not use stepladders whilst operating the product.
5. Use the product only in daylight or good artificial light.
6. Avoid operating your product on a wet hedge, where feasible.
7. Keep hands and feet away from the cutting means at all times and especially when switching on the motor.
8. Remove the battery pack :-
  - before leaving the product unattended for any period;
  - before clearing a blockage;
  - before checking, cleaning or working on the product;
  - if you hit an object. Do not use your product until you are sure that the entire product is in a safe operating condition;
  - if the product starts to vibrate abnormally. Check immediately. Excessive vibration can cause injury, before passing to another person.

### Maintenance and storage

1. Keep all nuts, bolts and screws secure to be sure the product is in safe working condition.
2. Replace worn or damaged parts for safety.
3. Be careful during adjustment of the product to prevent entrapment of the fingers between moving blades and fixed parts of the machine.
4. After use the product should be stored using the blade cover provided.
5. Store in a cool dry place and out of reach of children. Do not store outdoors.
6. Allow the product to cool for at least 30 minutes before storing.

### Battery

**Cordless Battery Powered Products require special care.**

1. **AVOID ACCIDENTAL STARTING**  
**KEEP HANDS AND FINGERS AWAY FROM THE SWITCH LEVER WHILE CARRYING THE PRODUCT.**
2. Always charge the product indoors and store in a cool dry place - out of the reach of children.
3. Use the charger with standard domestic household electrical outlets only.
4. Do not abuse the charger or charger cord.
5. Do not use the charger if the charger or cable is damaged.
6. Do not charge the battery or use the unit in an explosive or corrosive environment. Avoid areas where flammable liquids or gases are present to avoid creating a fire or explosion.
7. Do not attempt to repair the unit including the battery.
8. Do not insert any object into the motor area. Keep free of debris to avoid overheating.
9. Do not incinerate or mutilate the battery. Batteries contain hazardous chemicals. Dispose of properly.

## Battery

### Battery Care

1. If over a period of time the battery quickly runs down after a full 5-6 hour charging period, a replacement battery is needed.
2. There will be some charge present in the battery but to ensure maximum running time, recharge your product for 5-6 hours before use.
3. To prevent permanent battery damage, never store in a discharged condition.
4. Contact your local approved service centre/dealer/distributor for a replacement battery and for safe disposal of your old battery.
5. Battery  
18 Volt 1.3 Amp/Hour  
"High Power"  
No maintenance required

### • IMPORTANT

**DISPOSE OF YOUR OLD BATTERIES SAFELY**  
**DO NOT CUT OPEN, BURN OR INCINERATE.**

### Winter Storage

1. Fully charge for 5-6 hours before winter storage.
2. Avoid extended storage without re-charge.
3. Store in a cool dry place.

For further information on Battery replacement contact Husqvarna UK Ltd. Customer Service direct:-

Telephone : 0844 844 4558 **UK**

1800 882 350 **ROI**

Fax : 01325 302530

## Assembly

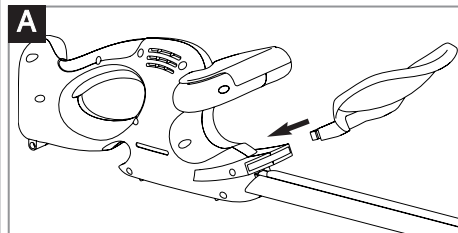

### Assembly of Handguard.

1. Insert Handguard into slot as illustrated in **figure A**, ensuring that it is securely located.  
**DO NOT USE THE PRODUCT WITHOUT FITTING THE HANDGUARD**

## Charging the Battery

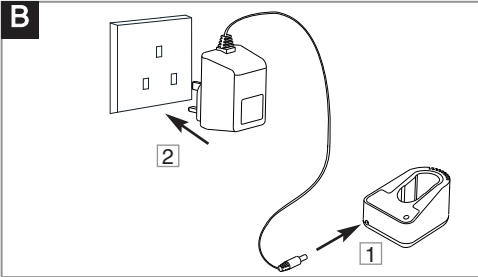

### Initial Charging Procedure

1. Use the charger indoors only.
2. Ensure the charger is not exposed to moisture. Keep the charger and the product dry at all times.
3. Connect the charger cable to the Charger Cradle (B1) and plug the Charger into a suitable household electrical wall socket and switch on (B2).
4. Place the Battery Pack into the Charger Cradle (C).
5. The red indicator lamp glows continuously during charging (C1)
6. Full charge will be achieved in 5-6 hours. During charging the charger becomes warm. This is normal and means the charger is operating correctly. When the Battery Pack is fully charged, the red indicator lamp will change to green.
7. Connect the Battery Pack to the product by pressing the two buttons either side of the Battery Pack and attaching to the back of the product (D)

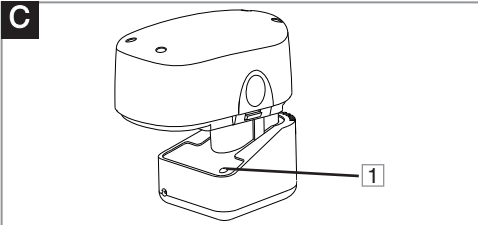

### Re-Charging Your Product

1. Re-charge the battery as soon as the cutting power of your cordless product begins to die and slow down.
2. Avoid running the product into "deep" discharge, i.e. avoid flattening the battery completely.
3. Follow the procedure outlined in the Initial Charging Procedure.
4. Charging the battery according to these instructions should ensure maximum battery life.

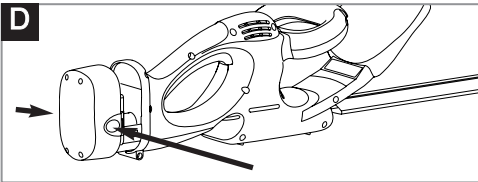

## Starting and Stopping

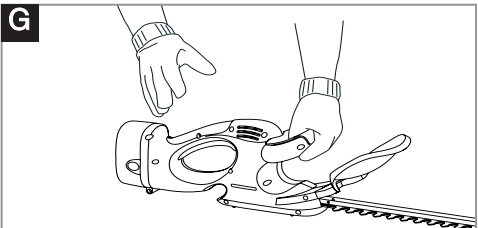
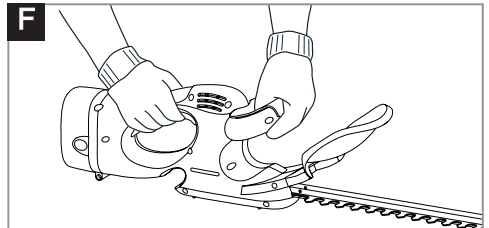
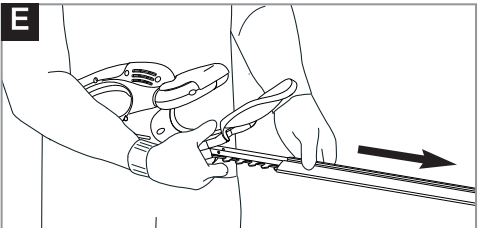

### Before starting your Hedgetrimmer.

1. Remove blade cover (E).

### To start your Hedgetrimmer

1. There are two switch levers fitted to your Hedgetrimmer.
2. Both switch levers need to be held in the operating position (See Fig F) for the product to start.

### To stop your Hedgetrimmer

- Move Hedgetrimmer away from cutting area before stopping.
1. To stop, release one of the switch levers. (Fig G)

## How to Use

### How to Use your Hedgetrimmer

1. Inspect area to be cut before each use - remove objects which can be thrown or become entangled in the cutting blades.
2. Always keep the Hedgetrimmer in front of your body. Hold handle firmly with both hands and stand in a secure and stable position.
3. Allow the cutting blades to reach full speed before entering the material to be cut.
4. Always work going away from people and solid objects such as walls, large stones, trees, vehicles etc.
5. If blade stalls, immediately stop the Hedgetrimmer and clear jammed debris from the cutting blades. Inspect blades and repair or replace as needed.

#### Top Cutting

Use a wide sweeping motion. **(H)** A slight downward tilt of the cutting blades in the direction of motion gives the best cutting results.

#### Side Cutting

When trimming the sides of the hedge, begin at the bottom and cut upwards **(J)**, tapering the hedge inward at the top. This shape will expose more of the hedge, resulting in more uniformed growth.

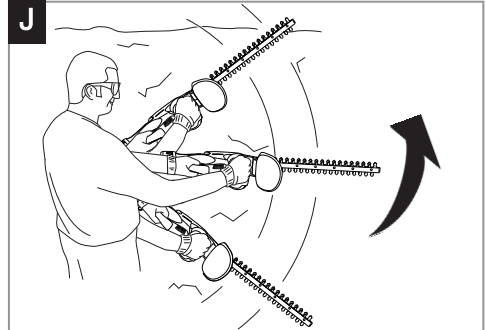
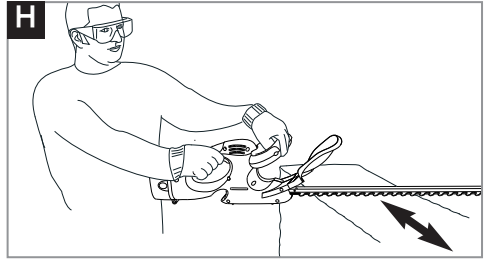

## Caring for your Hedgetrimmer

### Cleaning (K)

1. Using a soft brush - remove debris from all air intakes and cutting blade.
2. Wipe over surface of your hedgetrimmer with a dry cloth.

#### IMPORTANT

Never use water for cleaning your hedgetrimmer. Do not clean with chemicals, including petrol, or solvents - some can destroy critical plastic parts.

### Lubricating the Cutting Blade

For easier operation and longer life, lubricate the cutter blades before and after use. Apply the oil so that it runs between the two blades. **(L)**

### At the end of the Cutting Season.

1. Clean your Hedgetrimmer thoroughly.
2. Check that all nuts and bolts are secure.
3. Visually inspect the Hedgetrimmer for any worn or damaged parts, contact your local Service Centre if any parts require replacement.

### To store your Hedgetrimmer

- Ensure the blade cover is fitted before storage.
- Store in a dry place where your Hedgetrimmer is protected from damage.

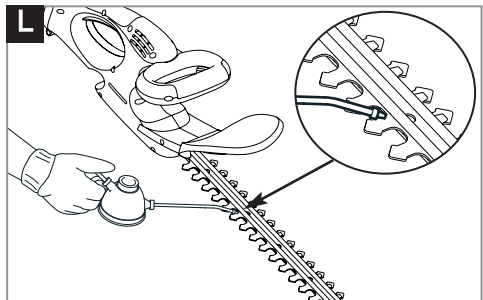
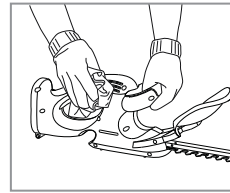
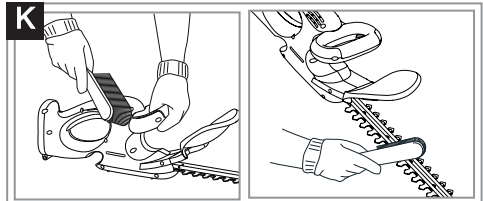

## Fault Finding Hints

### Cutting blade stops under load

1. Cut at a slower pace.
2. Recharge Battery.
3. If cutting blade still stops under load?  
Immediately remove the Battery Pack and consult your local approved Service Centre.

### Fails to stop when one switch lever is released.

Immediately remove the Battery Pack and consult your local approved Service Centre.

### Poor cut quality

1. Ensure the product is being used correctly (see How to Use)
2. Ensure blades are free from trapped debris
3. Damaged Blades?  
Immediately remove the Battery Pack and consult your local approved Service Centre.

### Excessive Vibration

Immediately remove the Battery Pack and consult your local approved Service Centre.

## Environmental Information

- Awareness of the environment must be considered when disposing of 'end-of-life' product.
- If necessary, contact your local authority for disposal information.

### BATTERY DISPOSAL

- This product contains a NiCd battery and should not be discarded with normal household waste at the end of its life.
- The battery must be removed from the product before disposal
- The battery should be disposed of safely.
- Do NOT dispose of battery to water.
- NiCd batteries can be harmful and should be disposed of through the recognised recycling facility in accordance with European Regulation
- Do NOT incinerate

The symbol  on the product or on its packaging indicates that this product may not be treated as household waste. Instead it shall be handed over to the applicable collection point for the recycling of electrical and electronic equipment.

By ensuring this product is disposed of correctly, you will help prevent potential negative consequences for the environment and human health, which could otherwise be caused by inappropriate waste handling of this product.

For more detailed information about recycling of this product, please contact your local council office, your household waste disposal service or the shop where you purchased the product.

## Guarantee & Guarantee Policy

If any part is found to be defective due to faulty manufacture within the guarantee period, Husqvarna UK Ltd., through its Authorised Service Repairers will effect the repair or replacement to the customer free of charge providing:

- (a) The fault is reported directly to the Authorised Repairer.
  - (b) Proof of purchase is provided.
  - (c) The fault is not caused by misuse, neglect or faulty adjustment by the user.
  - (d) The failure has not occurred through fair wear and tear.
  - (e) The machine has not been serviced or repaired, taken apart or tampered with by any person not authorised by Husqvarna UK Ltd..
  - (f) The machine has not been used for hire.
  - (g) The machine is owned by the original purchaser.
  - (h) The machine has not been used outside of the country for which it was specified.
  - (i) The machine has not been used commercially.
- \* This guarantee is additional to, and in no way diminishes the customers statutory rights.

Failures due to the following are not covered, therefore it is important that you read the instructions contained in this Operator's Manual and understand how to operate and maintain your machine:

### Failures not covered by guarantee

- \* Replacing worn or damaged blades
- \* Failures as a result of not reporting an initial fault.
- \* Failures as a result of sudden impact.
- \* Failures as a result of not using the product in accordance with the instructions and recommendations contained in this Operator's Manual.
- \* Machines used for hire are not covered by this guarantee.
- \* The following items listed are considered as wearing parts and their life is dependent on regular maintenance and are, therefore not normally subject to a valid warranty claim: Blades.

### \* Caution!

Husqvarna UK Ltd. does not accept liability under the warranty for defects caused in whole or part, directly or indirectly by the fitting of replacement parts or additional parts that are not either manufactured or approved by Husqvarna UK Ltd., or by the machine having been modified in any way

## Service Recommendations

1. We strongly recommend that your product is serviced at least every twelve months, more often in a professional application.
2. Always use genuine Husqvarna Spare Parts.
3. Prepacked spares are available from most Husqvarna UK Ltd. stockists.
4. Your product is uniquely identified by a silver and black product rating label
5. If you have a problem with your machine contact your local Approved Service Centre ensuring you have full details of your product as described on the product rating label.
6. **Should it be necessary for work to be carried out by your Service Centre, it is important to take your complete machine including cable and any extension cables used.**  
A network of specialist dealers can be found in your local Yellow Pages. To obtain service on your product simply telephone or visit your local Service Centre. Should you require service under the terms of our guarantee the Service Centre will require proof of purchase.  
**All of the centres listed stock genuine Husqvarna Spare Parts.**  
**NOTE: Our Service Repairers act on their own behalf and are not empowered to commit or legally bind Husqvarna UK Ltd. in any manner whatsoever.**

## EC Declaration of Conformity

Husqvarna AB, 561 82, Huskvarna, Sweden

Declare under our sole responsibility that the product(s);

Category.....**Battery Hedgetrimmer**

Type(s) .....**ECC500**

Identification of Series.....**See Product Rating Label**

Year of Construction.....**See Product Rating Label**

Conforms to the essential requirements & provisions of the following EC Directives:

**2006/42/EC, 2004/108/EC, 2000/14/EC**

based on the following EU harmonized standards applied:

**EN60745-1, EN60745-2-15, EN50366, EN55014-1, EN55014-2, EN61000-3-2, EN61000-3-3**

The maximum A weighted sound pressure level  $L_{pA}$  at the work station, measured according to EN60745-2-15, corresponds to the **Level** given in the table.

The maximum hand / arm vibration weighted value, measured according to EN60745-2-15, on a sample of the above product(s) corresponds to the **Value**  $a_{th}$  given in the table.

The declared vibration total value has been measured in accordance with a standard test method and may be used for comparing one tool with another.

The declared vibration total value may also be used in a preliminary assessment of exposure.

**Warning:**

The vibration emission during actual use of the power tool can differ from the declared total value depending on the ways in which the tool is used.

Operators should identify safety measures to protect themselves that are based on an estimation of exposure in the actual conditions of use (taking account of all parts of the operating cycle such as the times when the tool is switched off and when it is running idle in addition to the trigger time).

2000/14/EC: The Measured Sound Power  $L_{WA}$  & Guaranteed Sound Power  $L_{WA}$  values are according to the tabulated figures.

Conformity Assessment Procedure..... Annex V

Notified Body..... Intertek, Cleeve Road  
Leatherhead, Surrey  
KT22 7SB, England

Newton Aycliffe 26/01/2011

P. Lameli

Global R&D Director - Hand held

Keeper of technical documentation



Type	ECC500
Blade length (cm)	50
Measured Sound Power $L_{WA}$ (dB(A))	93
Guaranteed Sound Power $L_{WA}$ (dB(A))	101
<b>Level</b> $L_{pA}$ (dB(A))	82
Uncertainty $K_{pA}$ (dB(A))	2.5
<b>Value</b> $a_{th}$ (m/s <sup>2</sup> )	1.11
Uncertainty $K_{ah}$ (m/s <sup>2</sup> )	1.5
Weight (Kg)	3.2

Our policy of continuous improvement means that the specification of products may be altered from time to time without prior notice.

Copyright © 2011 Flymo S.A. All rights reserved. Flymo® and other product and feature names are registered or unregistered trademarks of Flymo S.A.

Husqvarna AB  
561 82  
Huskvarna  
Sweden

5052865-01





## Free Manuals Download Website

<http://myh66.com>

<http://usermanuals.us>

<http://www.somanuals.com>

<http://www.4manuals.cc>

<http://www.manual-lib.com>

<http://www.404manual.com>

<http://www.luxmanual.com>

<http://aubethermostatmanual.com>

Golf course search by state

<http://golfingnear.com>

Email search by domain

<http://emailbydomain.com>

Auto manuals search

<http://auto.somanuals.com>

TV manuals search

<http://tv.somanuals.com>