

Table of Contents

Introduction	4
Instrument Cluster	8
Warning and control lights	8
Gauges	14
Entertainment Systems	16
AM/FM stereo with CD	16
Climate Controls	30
Electronic automatic temperature control	30
Lights	43
Headlamps	43
Turn signal control	46
Bulb replacement	46
Driver Controls	54
Windshield wiper/washer control	54
Steering wheel adjustment	55
Power windows	56
Mirrors	58
Speed control	59
Locks and Security	76
Keys	76
Locks	76
Anti-theft system	77
Seating and Safety Restraints	87
Seating	87
Safety restraints	90
Air bags	100
Child restraints	113

Table of Contents

Driving	125
Starting	125
Brakes	129
Traction control	131
Transmission operation	133
Vehicle loading	139
Trailer towing	141
Roadside Emergencies	145
Getting roadside assistance	145
Hazard flasher switch	146
Fuel pump shut-off switch	146
Fuses and relays	147
Changing tires	156
Jump starting	161
Wrecker towing	167
Customer Assistance	168
Reporting safety defects (U.S. only)	177
Cleaning	178
Maintenance and Specifications	184
Engine compartment	186
Engine oil	187
Battery	190
Fuel information	199
Air filter(s)	211
Part numbers	216
Refill capacities	216
Lubricant specifications	218

Table of Contents

Accessories	223
Index	225

All rights reserved. Reproduction by any means, electronic or mechanical including photocopying, recording or by any information storage and retrieval system or translation in whole or part is not permitted without written authorization from Ford Motor Company. Ford may change the contents without notice and without incurring obligation.

Copyright © 2002 Ford Motor Company

Introduction

CALIFORNIA Proposition 65 Warning



WARNING: Engine exhaust, some of its constituents, and certain vehicle components contain or emit chemicals known to the State of California to cause cancer and birth defects or other reproductive harm. In addition, certain fluids contained in vehicles and certain products of component wear contain or emit chemicals known to the State of California to cause cancer and birth defects or other reproductive harm.

CONGRATULATIONS

Congratulations on acquiring your new Ford Motor Company product. Please take the time to get well acquainted with your vehicle by reading this handbook. The more you know and understand about your vehicle the greater the safety and pleasure you will derive from driving it.

For more information on Ford Motor Company and its products visit the following website:

- In the United States: www.ford.com
- In Canada: www.ford.ca
- In Mexico: www.ford.com.mx
- In Australia: www.ford.com.au

Additional owner information is given in separate publications.

This Owner's Guide describes every option and model variant available and therefore some of the items covered may not apply to your particular vehicle. Furthermore, due to printing cycles it may describe options before they are generally available.

Remember to pass on the Owner's Guide when reselling the vehicle. It is an integral part of the vehicle.



Fuel pump shut-off switch In the event of an accident the safety switch will automatically cut off the fuel supply to the engine. The switch can also be activated through sudden vibration (e.g. collision when parking). To reset the switch, refer to the *Fuel pump shut-off switch* in the *Roadside emergencies* chapter.

SAFETY AND ENVIRONMENT PROTECTION

Warning symbols in this guide

How can you reduce the risk of personal injury and prevent possible damage to others, your vehicle and its equipment? In this guide, answers to such questions are contained in comments highlighted by the warning triangle symbol. These comments should be read and observed.

Warning symbols on your vehicle

When you see this symbol, it is imperative that you consult the relevant section of this guide before touching or attempting adjustment of any kind.



Protecting the environment

We must all play our part in protecting the environment. Correct vehicle usage and the authorized disposal of waste cleaning and lubrication materials are significant steps towards this aim. Information in this respect is highlighted in this guide with the tree symbol.



BREAKING-IN YOUR VEHICLE

There are no particular guidelines for breaking-in your vehicle. During the first 1,600 km (1,000 miles) of driving, vary speeds frequently. This is recommended to give the moving parts a chance to break in.

SPECIAL NOTICES

Emission warranty

The New Vehicle Limited Warranty includes Bumper-to-Bumper Coverage, Safety Restraint Coverage, Corrosion Coverage, and 7.3L Power Stroke Diesel Engine Coverage. In addition, your vehicle is eligible for Emissions Defect and Emissions Performance Warranties. For a detailed description of what is covered and what is not covered, refer to the *Warranty Guide* that is provided to you along with your Owner's Guide.

















Introduction

These are some of the symbols you may see on your vehicle.

Vehicle Symbol Glossary

Safety Alert		See Owner's Guide	
Fasten Safety Belt		Air Bag-Front	
Air Bag-Side		Child Seat	
Child Seat Installation Warning		Child Seat Lower Anchor	
Child Seat Tether Anchor		Brake System	
Anti-Lock Brake System		Brake Fluid - Non-Petroleum Based	
Traction Control		AdvanceTrac	
Master Lighting Switch		Hazard Warning Flasher	
Fog Lamps-Front		Fuse Compartment	
Fuel Pump Reset		Windshield Wash/Wipe	
Windshield Defrost/Demist		Rear Window Defrost/Demist	

Vehicle Symbol Glossary

Power Windows Front/Rear		Power Window Lockout	
Child Safety Door Lock/Unlock		Interior Luggage Compartment Release Symbol	
Panic Alarm		Engine Oil	
Engine Coolant		Engine Coolant Temperature	
Do Not Open When Hot		Battery	
Avoid Smoking, Flames, or Sparks		Battery Acid	
Explosive Gas		Fan Warning	
Power Steering Fluid		Maintain Correct Fluid Level	
Emission System		Engine Air Filter	
Passenger Compartment Air Filter		Jack	
Check fuel cap		Low tire warning	

Instrument Cluster

WARNING LIGHTS AND CHIMES

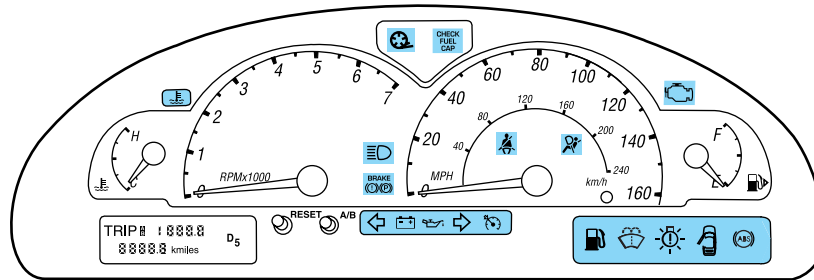

Warning lights and gauges can alert you to a vehicle condition that may become serious enough to cause expensive repairs. A warning light may illuminate when a problem exists with one of your vehicle's functions. Many lights will illuminate when you start your vehicle to make sure the bulb works. **If any light remains on after starting the vehicle, have the respective system inspected immediately.**

Check engine

Illuminates briefly to ensure the system is functional. If it comes on after the engine is started, one of the engine's emission control systems may be malfunctioning. The light may illuminate without a driveability concern being noted and will not require towing.

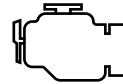

Light turns on solid:

Temporary malfunctions may cause your light to illuminate. Examples are:

- The vehicle has run out of fuel.
- Poor fuel quality or water in the fuel.
- The fuel cap may not have been properly installed and securely tightened.

These temporary malfunctions can be corrected by filling the fuel tank with high quality fuel of the recommended octane and/or properly installing and securely tightening the fuel cap. After three driving cycles without these or any other temporary malfunctions present, the light should turn off. (A driving cycle consists of a cold engine startup followed by mixed city/highway driving.) No additional vehicle service is required.

Instrument Cluster

If the light remains on, have your vehicle serviced at the first available opportunity.

Light is blinking:



Engine misfire is occurring which could damage your catalytic converter.

You should drive in a moderate fashion (avoid heavy acceleration and deceleration) and have your vehicle serviced at the first available opportunity.

Under engine misfire conditions, excessive exhaust temperatures could damage the catalytic converter, the fuel system, interior floor coverings or other vehicle components, possibly causing a fire.

Check fuel cap

Illuminates when the fuel cap is not installed correctly. Check the fuel cap for proper installation. When the fuel filler cap is properly re-installed, the light(s) will turn off after a period of normal driving. Continuing to operate the vehicle with the check fuel cap light on, or a mis-installed fuel cap can activate the *Service Engine Soon/Check Engine* warning light.

**CHECK
FUEL
CAP**

It may take a long period of time for the system to detect an improperly installed fuel filler cap.

For more information, refer to *Fuel filler cap* in the *Maintenance and specifications* chapter.

Brake system warning

To confirm the brake system warning light is functional, it will momentarily illuminate when the ignition is turned to the ON position (alternatively for some vehicles when the ignition is moved from the ON position to START position, the light will momentarily illuminate prior to reaching the START position). It also illuminates if the parking brake is engaged. If the brake system warning light does not illuminate as described, seek service immediately. Illumination after the parking brake is released indicates low brake fluid

BRAKE

Instrument Cluster

level or a brake system malfunction and the brake system should be serviced immediately by a qualified technician. Refer to *Brakes* in the *Driving* chapter for more information.

Anti-lock brake system (ABS)

To confirm the anti-lock brake system (ABS) warning light is functional it will momentarily illuminate when the ignition is turned to the ON position

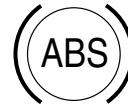

(alternatively for some vehicles when the ignition is moved from the ON position to the START position, the light will momentarily illuminate just prior to reaching the START position). If the light remains on, continues to flash or fails to illuminate, have the ABS serviced immediately. If the ABS light remains on, it means the anti-lock brake system has malfunctioned and is disabled, however, the normal brake system will still function unless the brake warning light also remains illuminated and parking brake is off. Refer to *Brakes* in the *Driving* chapter for more information.

Transmission PRNDL indicator

Displays the gearshift positions. If an “E” character is displayed or flashing, this indicates a transmission malfunction, contact your dealer immediately. Operating the transmission with the “E” character illuminated may cause additional damage to the transmission.

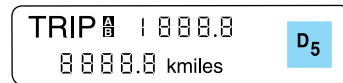

Air bag readiness

Illuminates to confirm that the air bags (front and side) are operational. If the light fails to illuminate, continues to flash or remains on, have the system serviced immediately.



Instrument Cluster

Safety belt

Illuminates to remind you to fasten your safety belts. For more information, refer to the *Seating and safety restraints* chapter.



Engine coolant temperature

Illuminates when the engine coolant temperature is high. Stop the vehicle as soon as safely possible, switch off the engine and let it cool.



Never remove the coolant recovery cap while the engine is running or hot.

Refer to *Engine coolant* in the *Maintenance and specifications* chapter. If light stays on or continues to turn on after the vehicle warms up, have your vehicle serviced.

Engine oil pressure

Illuminates when the oil pressure falls below the normal range. Check the oil level and add oil if needed. Refer to *Engine oil* in the *Maintenance and specifications* chapter.

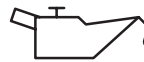

Charging system

Illuminates when the battery is not charging properly.



Traction Control[™] active

Illuminates when the Traction Control[™] system is active. It will be lit for a minimum of four seconds or for the duration of the Traction Control[™] event.



For more information, refer to the *Driving* chapter.

Instrument Cluster

Low fuel

Illuminates when the fuel level in the fuel tank is at or near empty, refer to *Fuel gauge* in this chapter for more information.



Speed control

Illuminates when the speed control is activated.

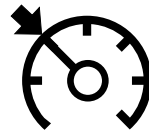

Low washer fluid

Illuminates when the windshield washer fluid is low.



Turn signal

Illuminates when the turn signals or the hazard lights are turned on. If the lights stay on continuously or flash faster, check for a burned-out bulb.



Bulb Warning

Illuminates when one of the exterior bulbs has burned out.



High beams

Illuminates when the high beam headlamps are turned on.



Instrument Cluster

Door ajar

Illuminates when any door or the trunk is open.



Safety belt warning chime

Sounds to remind you to fasten your safety belts.

BeltMinder™ chime

Sounds intermittently to remind you to fasten your safety belts.

Supplemental restraint system (SRS) warning chime

Sounds when a malfunction in the supplemental restraint system (front or side airbags) has been detected. Have the supplemental restraint system inspected immediately.

Headlamps on warning chime

Sounds when the headlamps or parking lamps are on, the key is removed from the ignition and the driver's door is opened.

Key-in-ignition warning chime

Sounds when the key is left in the ignition and the driver's door is opened.

Turn signal chime

Sounds when the turn signal lever has been activated to signal a turn and not turned off after the vehicle is driven more than 0.8 km (1/2 mile).

Instrument Cluster

GAUGES

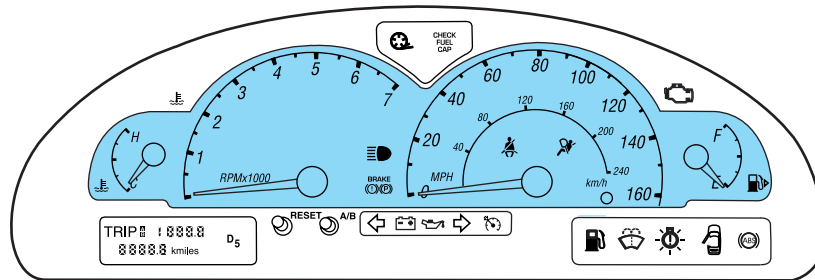

Engine coolant temperature gauge

Indicates the temperature of the engine coolant. At normal operating temperature, the needle remains within the normal area (the area between the “H” and “C”); if the needle goes above the normal range, the engine is overheating. Stop the vehicle as soon as safely possible, switch off the engine immediately and let the engine cool. Refer to *Engine coolant* in the *Maintenance and specifications* chapter.

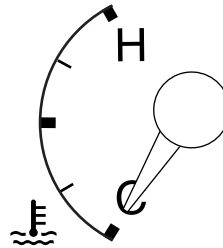

 Never remove the coolant reservoir cap while the engine is running or hot. Steam and scalding liquid from a hot cooling system can burn you badly.

This gauge indicates the temperature of the engine coolant, not the coolant level. If the coolant is not at its proper level the gauge indication will not be accurate.

Instrument Cluster

Fuel gauge

Displays approximately how much fuel is in the fuel tank. The fuel gauge may vary slightly when the vehicle is in motion or on a grade.

When refueling the vehicle from an empty indication, the amount of fuel that can be added will be less than the advertised capacity due to the reserve fuel.

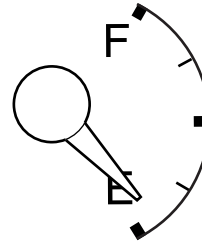

Speedometer

Indicates the current vehicle speed.

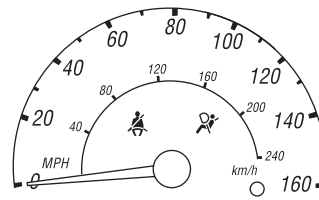

Odometer

Registers the total kilometers (miles) of the vehicle.

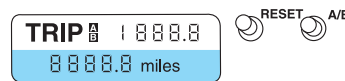

Trip odometer

Registers the kilometers (miles) of individual journeys. To reset, depress the control.

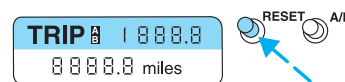

To switch the display from Trip A to the Trip B feature, depress the A/B control.

Tachometer

Indicates the engine speed in revolutions per minute.

Driving with your tachometer pointer continuously at the top of the scale may damage the engine.

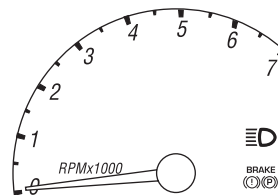

Entertainment Systems

AUDIOPHILE AM/FM STEREO IN DASH SIX CD RADIO

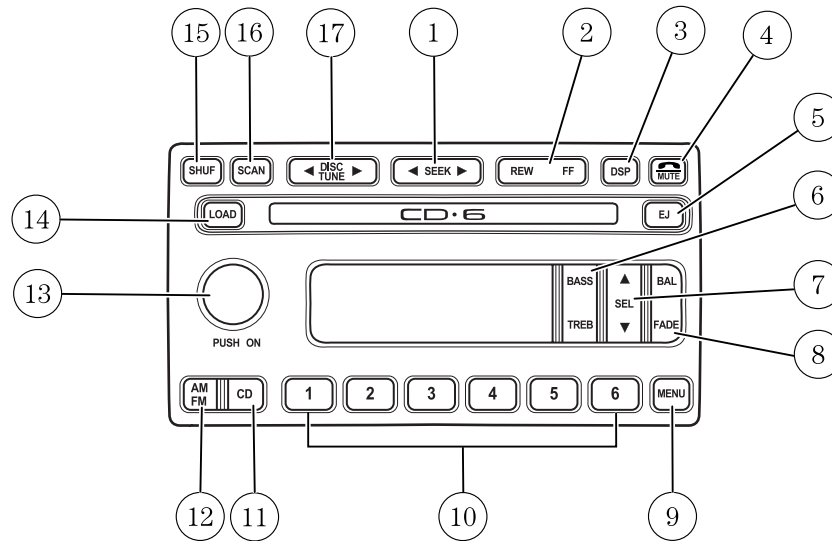

- | | |
|--------------------------------|-------------------------------|
| 1. Seek control | 10. Radio preset controls |
| 2. Rewind/Fast forward control | 11. CD control |
| 3. DSP control | 12. AM/FM control |
| 4. Phone/mute control | 13. ON/OFF and volume control |
| 5. Eject control | 14. Load control for CDs |
| 6. Bass/treble control | 15. Shuffle control |
| 7. Select control | 16. Scan control |
| 8. Balance/fade control | 17. Tune control |
| 9. Menu control | |

Volume/power control

Press the control to turn the audio system on or off. Turn the control to raise or lower volume.

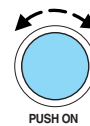

Entertainment Systems

If the volume is set above a certain level and the ignition is turned off, the volume will come back on at a “nominal” listening level when the ignition switch is turned back on.

Speed sensitive volume

With this feature, radio volume changes automatically and slightly with vehicle speed to compensate for road and wind noise.

The recommended level for speed sensitive volume is from level 1 through level 3. Level 0 turns the speed sensitive volume off and level 7 is the maximum setting.

To engage the speed sensitive volume feature, press and hold the volume control for five seconds (with the radio on), then press:

- ▲ to increase volume compensation.
- ▼ to decrease or shut off the volume compensation.

The selected level will appear in the display.

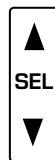

AM/FM select

The AM/FM select control works in radio and CD modes.



AM/FM select in radio mode

This control allows you to select AM or FM frequency bands. Press the control to switch between AM, FM1 or FM2 memory preset stations.

AM/FM select in CD mode

Press this control to stop CD play and begin radio play.

Tune/disc adjust

The tune control works in radio or CD mode.

Entertainment Systems

Tune adjust in radio mode

- Press ◀ to move to the next frequency down the band (whether or not a listenable station is located there). Hold the control to move through the frequencies quickly.
- Press ▶ to move to the next frequency up the band (whether or not a listenable station is located there). Hold for quick movement.



Disc adjust for CD mode

- Press ◀ to select the previous disc. (Play will begin on the first track of the disc unless shuffle mode is engaged.) Refer to *Shuffle feature* for more information. Hold the control to continue reversing through the discs.
- Press ▶ to select the next disc. Hold the control to fast-forward through the remaining discs.



Seek function

The seek function works in radio or CD mode.

Seek function in radio mode

- Press ◀ to find the next listenable station down the frequency band. SEEK DOWN will display.
- Press ▶ to find the next listenable station up the frequency band. SEEK UP will display.



Seek function in CD mode

- Press ◀ to seek to the previous track of the current disc. If the beginning of the disc is reached, the CD player seeks to the beginning of the last track on the current disc and begins playing.
- Press ▶ to seek forward to the next track of the current disc. After the last track has been completed, the first track of the current disc will automatically replay.



Entertainment Systems

Scan function

The scan function works in radio or CD mode.

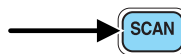

Scan function in radio mode

Press the SCAN control to hear a brief sampling of all listenable stations on the frequency band. Press the SCAN control again to stop the scan mode.

Scan function in CD mode

Press the SCAN control to hear a short sampling of all selections on the CD. (The CD scans in a forward direction, wrapping back to the first track at the end of the CD.) To stop on a particular selection, press the control again.

Radio station memory preset

The radio is equipped with six station memory preset controls. These controls can be used to select up to six preset AM stations and twelve FM stations (six in FM1 and six in FM2).

Setting memory preset stations

1. Select the frequency band with the AM/FM select control. Press the AM/FM control to toggle between AM, FM1, or FM2.
2. Press the SEEK control to access the next listenable station up or down the frequency band. Press the TUNE control to go up or down the listening band in individual increments.
3. Select a station. Refer to *Seek function* for more information on selecting a station.
4. Press and hold a memory preset control. The playing media will mute momentarily. When the sound returns, the station is held in memory on the control you selected. The display will read **SAVED**.

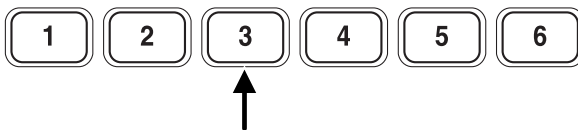

Autostore

Autostore allows you to set the strongest local radio stations without losing your original manually set preset stations. This feature is helpful on trips when you travel between cities with different radio stations.

Entertainment Systems

Starting autostore

1. Press and momentarily hold the AM/FM control.
2. AUTOSET will flash in the display as the frequency band is scrolled through.



3. When the six strongest stations are filled, the station stored in memory preset control 1 will start playing.

If there are fewer than six strong stations available on the frequency band, the remaining memory preset controls will all store the last strong station available.

To deactivate autostore and return to your audio system's manually set memory stations, press the AM/FM control again.

CD select

CD mode may be entered by pressing the CD control and the LOAD control. Load the CD into the audio system. The first track of the disc will begin playing. After that, CD play will begin where it stopped last.



If an alternative CD is desired, press the corresponding preset control (1–6) of a loaded CD, or press the TUNE control to access the other loaded CDs.

NO CD will display if the CD control is activated when there is not a CD present in the audio system.

If the CD control is pressed followed by with a preset number and that particular slot is empty, NO CD will display and the system will begin to play the next available disc.

CD units are designed to play commercially pressed 12 cm (4.75 in) audio compact discs only. Due to technical incompatibility, certain recordable and re-recordable compact discs may not function correctly when used in Ford CD players. Irregular shaped CDs, CDs with a scratch protection film attached, and CDs with homemade paper (adhesive) labels should not be inserted into the CD player. The label may peel and cause the CD to become jammed. It is recommended that homemade CDs be identified with permanent felt tip marker rather than adhesive labels. Ball point pens may damage CDs. Please contact your dealer for further information.

Entertainment Systems

Display description

Six circles are always lit in the digital display. These signify the six CD slots in the audio system. When a disc is loaded into a particular slot (1–6), the number inside that specific circle lights. If the circle is empty, there is no CD in that particular slot.

Load

The load feature allows you to load single CDs into the player internal to the radio.



This six disc CD player is equipped with a CD door. Compact discs should only be inserted into the player after the CD door has been opened by the player. Do not attempt to force the door open. Compact discs should only be loaded by pressing the LOAD control.

Press the LOAD control. (You can choose which slot will be loaded by pressing the desired preset number. If you do not choose a slot, the system will choose the next available one.) Wait until the CD door opens. Load the CD into the player. LOADING CD# is displayed. When the CD has been loaded, the door will close and the CD will begin to play. For example, to load a CD into slot 2, press the LOAD control and then press preset 2.

Auto load

This feature allows you to autoload up to 6 discs into the multi disc CD player internal to the radio.



Press and hold the LOAD control until AUTOLOAD # is displayed. The CD door will open. Load the desired discs, one at a time. The CD is loaded into position and the audio system will display CD#. Each time the CD door opens, INSERT CD# is displayed. The door will close and the player will move to the next slot after each disc has been loaded. The process is repeated until all 6 slots are full. The audio system plays the last CD loaded and the display is updated. If some slots are already full and autoloading is activated, the system will fill all empty slots.

Entertainment Systems

Eject

Press the EJ control to stop and eject a CD. You can choose which CD will be ejected by pressing the



EJ control and the desired preset number (1–6). For example, to eject CD 2, press the EJ control and then press the preset 2 control. If you do not choose a specific CD, the player will eject the current CD.

If a CD is ejected and not removed from the door of the CD player, the player will automatically reload the CD. This feature may be used when the ignition is ON or OFF.

Auto eject

Press and momentarily hold the EJ control to engage auto eject. All CDs which are present in the player will



be ejected one at a time. If a CD is ejected and not removed from the door of the CD player, the player will automatically reload the CD. This feature may be used when the ignition is ON or OFF.

Rewind

The rewind control works in CD modes.



Press and hold the REW control until the desired selection is reached. If the beginning of the disc is reached, the CD will begin play at the first track. Release the control to disengage rewind mode.

When in rewind mode, your audio system will automatically lower the volume level of the playing media.

Fast forward

The fast forward control works in CD modes.



Press and hold the FF control until the desired selection is reached. If the end of the disc is reached, the CD will return to the first track. Release the control to disengage fast forward mode.

When in fast forward mode, your audio system will automatically lower the volume level of the playing media.

Entertainment Systems

Shuffle feature

Press the SHUF control until the desired shuffle mode is displayed. The audio system will then engage the desired shuffle mode.



When engaged, the shuffle feature has two different modes: SHUFFLE DISC and SHUFFLE TRK.

SHUFFLE DISC randomly plays tracks from all the discs presently in the audio system.

SHUFFLE TRK plays all the tracks on the current disc in random order.

Compression feature

The compression feature operates in CD mode and brings soft and loud CD passages together for a more consistent listening level.

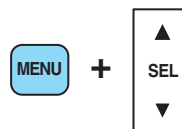

Press the MENU control until compression status is displayed. Press the SEL control to enable the compression feature when COMPRESS OFF is displayed. Press the SEL control again to disable the feature when COMPRESS ON is displayed.

Bass adjust

The bass adjust control allows you to increase or decrease the audio system's bass output.

Press the BASS control. Use the SEL control to increase or decrease the amount of bass.

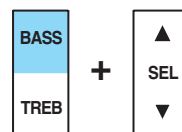

Treble adjust

The treble adjust control allows you to increase or decrease the audio system's treble output.

Press the TREB control. Use the SEL control to increase or decrease the amount of treble.



Entertainment Systems

Speaker balance adjust

Speaker sound distribution can be adjusted between the right and left speakers.

Press the BAL control. Use the SEL control to adjust the sound between the left and right speakers.



Speaker fade adjust

Speaker sound can be adjusted between the front and rear speakers.

Press the FADE control. Use the SEL control to adjust the sound between the front and rear speakers.



Menu mode

The MENU control allows you to access many different features within your audio system. There are three sets of menus available depending upon which mode or feature is activated.

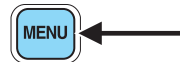

While in FM mode, two menus are available. **If RDS is turned OFF**, you can access the following:

- SELECT HOURS — Refer to *Setting the clock*.
- SELECT MINUTES — Refer to *Setting the clock*.
- RDS OFF — Refer to *Radio data system feature*.

If RDS is turned ON, you can access the following:

- TRAFFIC ON/OFF-Refer to *Traffic announcements*.
- FIND type-Refer to *Program type*.
- SHOW (NAME, TYPE, NONE)- Refer to *Radio data system feature*.
- RDS ON— Refer to *Radio data system feature*.
- SELECT HOURS — Refer to *Setting the clock*.
- SELECT MINUTES —Refer to *Setting the clock*.

When in CD mode, you can access: SELECT HOURS, SELECT MINUTES or COMP ON/OFF.

Entertainment Systems

SELECT HOURS, SELECT MINUTES— Allows you to adjust the hours and minutes. Refer to *Setting the clock*.

TRAFFIC ON/OFF— Traffic announcements can be programmed as local or distant. Refer to *Traffic announcements*.

RDS ON/OFF— This feature allows your audio system to receive text information from RDS-equipped FM radio stations. Refer to *Radio Data System feature*.

FIND type — Allows you to select your desired FM program type and search for that selection.

SHOW — Allows you to select from **NAME** (displays the name of the radio station), **TYPE** (displays the RDS program type: rock, jazz, etc.), or **NONE** (deactivates the RDS display).

Radio data system (RDS) feature

This feature allows your audio system to receive text information from RDS-equipped FM radio stations.

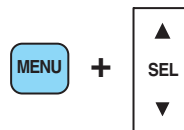

To activate RDS:

- When in FM mode, press the MENU control until RDS OFF displays.
- Press the SEL control to engage this feature (RDS ON).

RDS features:

Once the RDS feature is on, press the MENU control to scroll through the following selections:

Traffic announcements

This feature allows you to hear traffic announcements while in CD mode. These announcements are broadcast by traffic capable RDS stations.

When in this mode, traffic announcements will interrupt radio and CD play.

- Press the MENU control until TRAFFIC is displayed.
- Press the SEL control to engage the feature. The display will read TRAFFIC ON.

This feature also allows you to control the volume of traffic announcements. With the display reading TRAFFIC ON, adjust the volume using the volume control to the desired level. The volume level will show at the bottom of the display. Interrupting traffic announcements will be at the selected volume level.

Entertainment Systems

To disengage the feature, press the MENU control until TRAFFIC ON displays. Press the SEL control. The display will read TRAFFIC OFF.

Traffic announcements are not available in most U.S. markets.

Program type

This feature allows you to search for RDS stations selectively by their program type.

Press the MENU control until FIND program type is displayed.

Use the SEL control to select the program type. With the feature on, use the SEEK or SCAN control to

find the desired program type from the following selections:

- Classic
- Country
- Info
- Jazz
- Oldies
- R & B
- Religious
- Rock
- Soft
- Top 40

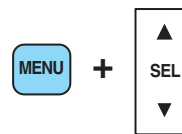

Show

This feature allows you to select the type of RDS broadcast information the radio will regularly show in the display.

With RDS activated, press the MENU control until SHOW is displayed.

Use the SEL control to select TYPE

(displays the RDS program type: rock, jazz, etc), NAME (displays the name of the radio station) or NONE (deactivates the RDS display).

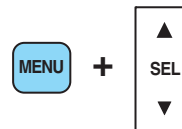
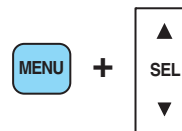

Digital signal processing

The digital signal processing (DSP) feature allows you to change the signal mode to suit your listening tastes.

Entertainment Systems

Press the DSP control to access the DSP menu. Press the SEL control to enter one of the following modes:

- DSP OFF
- SIGNAL MODE
- OCCUPANCY MODE



Use the SEL control to select the desired signal mode (the selected mode will appear in the display). The following signal modes can be selected:



- DSP OFF—disengages the feature
- NEWS—"voice-only" type of sound with a limited audio band
- JAZZ CLUB—jazz club with clearly reflected sounds
- HALL—rectangular concert hall capacity of about 2 000
- CHURCH—church with a high vault
- STADIUM—outdoor stadium with a capacity of about 30 000

Press the DSP control again to access the occupancy modes. Use the SEL control to optimize the sound based upon the occupants in the vehicle. The following occupancy modes can be selected:

- ALL SEATS
- DRIVER SEAT
- TOP DOWN

Mute mode

Press the control to mute the playing media. Press the control again to return to the playing media.



Setting the clock

Press the MENU control until SELECT HOUR or SELECT MINUTE is displayed. (The menu mode must be engaged to enable clock mode).

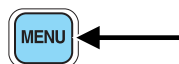

Entertainment Systems

Use the SEL control to manually set the time.

- Press ▲ to increase hours/minutes.
- Press ▼ to decrease hours/minutes.



Press the MENU control again to disengage the clock mode.

CLEANING COMPACT DISCS

Inspect all discs for contamination before playing. If necessary, clean discs only with an approved CD cleaner and wipe from the center out to the edge. Do not use circular motion.

CD CARE

- Handle discs by their edges only. Never touch the playing surface.
- Do not expose discs to direct sunlight or heat sources for extended periods of time.

CD units are designed to play commercially pressed 12 cm (4.75 in) audio compact discs only. Due to technical incompatibility, certain recordable and re-recordable compact discs may not function correctly when used in Ford CD players. Irregular shaped CDs, CDs with a scratch protection film attached, and CDs with homemade paper (adhesive) labels should not be inserted into the CD player. The label may peel and cause the CD to become jammed. It is recommended that homemade CDs be identified with permanent felt tip marker rather than adhesive labels. Ball point pens may damage CDs. Please contact your dealer for further information.

RADIO FREQUENCY INFORMATION

The Federal Communications Commission (FCC) and the Canadian Radio and Telecommunications Commission (CRTC) establish the frequencies AM and FM stations may use for their broadcasts. Allowable frequencies are:

AM 530, 540–1600, 1610 kHz

FM 87.7, 87.9–107.7, 107.9 MHz

Not all frequencies are used in a given area.

Entertainment Systems

RADIO RECEPTION FACTORS

Three factors can affect radio reception:

- **Distance/strength.** The further an FM signal travels, the weaker it is. The listenable range of the average FM station is approximately 40 km (24 miles). This range can be affected by “signal modulation.” Signal modulation is a process radio stations use to increase their strength/volume relative to other stations.
- **Terrain.** Hills, mountains and tall buildings between your vehicle’s antenna and the radio station signal can cause FM reception problems. Static can be caused on AM stations by power lines, electric fences, traffic lights and thunderstorms. Moving away from an interfering structure (out of its “shadow”) returns your reception to normal.
- **Station overload.** Weak signals are sometimes captured by stronger signals when you pass a broadcast tower. A stronger signal may temporarily overtake a weaker signal and play while the weak station frequency is displayed.

The audio system automatically switches to single channel reception if it will improve the reception of a station normally received in stereo.

AUDIO SYSTEM WARRANTIES AND SERVICE

Refer to the *Warranty Guide* for audio system warranty information.

If service is necessary, see your dealer or a qualified technician.

Climate Controls

DUAL AUTOMATIC TEMPERATURE CONTROL (DATC) SYSTEM

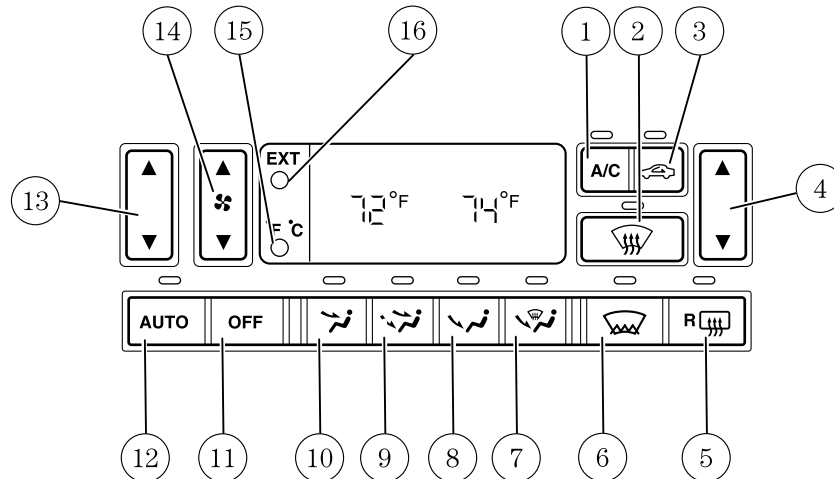

1. A/C control
2. Windshield defrost control
3. Recirculated air control
4. Passenger temperature control
5. Rear defrost control
6. Heated wiper rest/windshield control
7. Windshield and floor control
8. Floor control
9. Panel and floor control
10. Panel control
11. OFF control
12. AUTO control
13. Driver temperature control
14. Fan speed control
15. Temperature conversion control
16. Exterior temperature control

Climate Controls

Your vehicle is equipped with a Dual Automatic Temperature Control (DATC) system. The system will maintain a selected temperature and automatically control air flow.

You can override the automatic operation with any of the override controls.

The dual temperature zone feature allows the driver and front passenger to set their own independent temperature set points for individual comfort. The system uses common controls for air distribution and fan speed for both driver and passenger.

Turning the DATC system on, single zone control

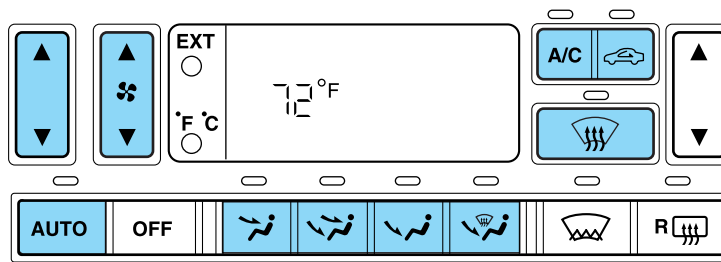

Press AUTO, any of the override controls, the fan speed control, or the driver temperature selection control to turn the DATC system on in the single zone control. While in single zone control the driver and passenger set temperatures are equalized, and only the driver's set temperature is displayed. The DATC system will only operate when the ignition is in the RUN position.

Climate Controls

Turning the DATC system on, dual zone control

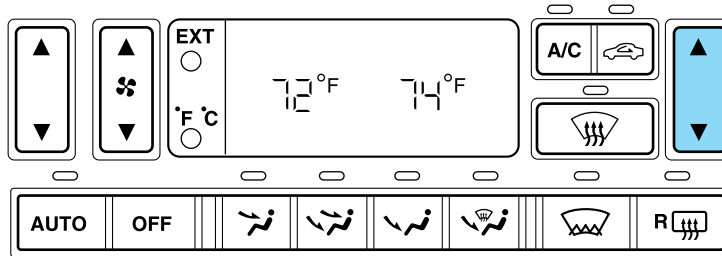

Press the passenger temperature control to turn the DATC system on in dual zone control. While in dual zone control, independent temperatures are maintained for both the driver and passenger, and both set temperatures are displayed.

Turning the system off

Press OFF. The outside temperature (EXT) function (if selected) will continue to operate until the ignition is turned off.

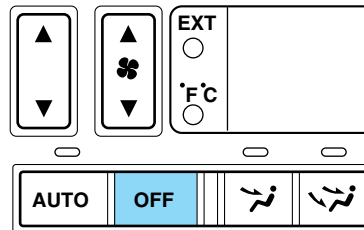

DATC automatic operation

Press AUTO and select the desired temperature. The selected temperature will appear in the display window, and an indicator above the AUTO control will light. The DATC system will either heat or cool the vehicle to achieve the selected temperature. The system will automatically determine the fan speed, airflow location and whether outside or recirculated air is required.

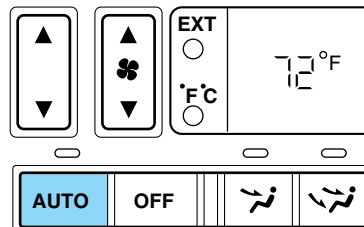

Climate Controls

When in AUTO and weather conditions require heat, the DATC directs the majority of the airflow to the floor area. The system will allow some airflow out of the defroster, demister outlets and outer instrument panel registers in order to reduce window fogging. Additionally, if the engine is not warm enough to provide heat, the fan will operate at a low speed and the airflow will be directed to the windshield or to the floor. In approximately 3½ minutes or less, the fan speed will start to increase and the airflow location will change to the floor area.

When in AUTO mode, the DATC system automatically controls the air conditioning operation, the fan speed, the airflow direction and determines whether outside or recirculated air is required. Manual control of the A/C, air recirculation and fan speed are available in auto mode.

If unusual conditions exist (i.e. window fogging), the manual override controls allow you to select airflow locations as necessary. To return to full automatic control, press the AUTO control.

DATC system AUTO temperature balance

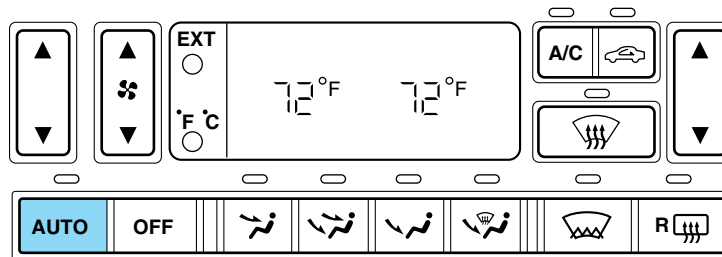

The AUTO control may be used to toggle between single zone control and dual zone control.

When in dual zone control (both driver and passenger set temperatures are displayed), press and hold the auto control for approximately two seconds to equalize the passenger set temperature with the driver set temperature. Only the driver set temperature will be displayed. This feature is useful when the driver is alone in the vehicle.

Climate Controls

When in single zone control (only driver set temperature displayed), press and hold the AUTO control for approximately two seconds to return the DATC system to dual zone control. Independent driver and passenger temperatures will be maintained. The previous passenger set temperature and the current driver set temperature are displayed.

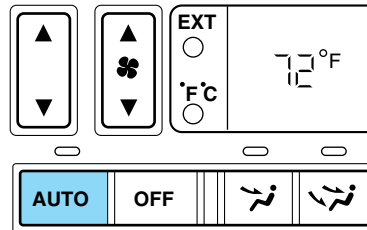

Driver side temperature selection

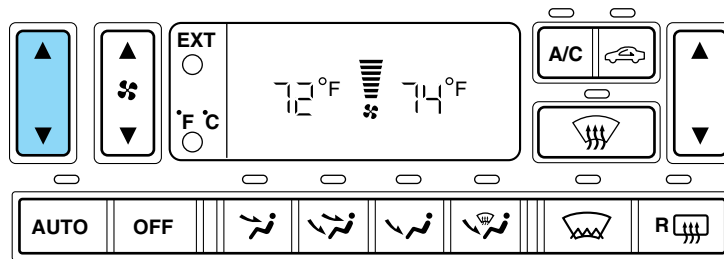

The display window indicates the selected temperature and manual control of fan speed () if automatic fan speed is not desired.

To control the temperature, select any temperature between 19°C (65°F) and 29°C (85°F) by pressing the temperature control on the driver side of the system.

For continuous maximum cooling, press the temperature control until 16°C (60°F) is shown in the display window. The DATC will continue maximum cooling (disregarding the displayed temperature) until a warmer temperature is selected by pressing the temperature control.

For continuous maximum heating, press the temperature control until 32°C (90°F) is shown in the display window. The DATC will continue maximum heating (disregarding the displayed temperature) until a cooler temperature is selected by pressing the temperature control.

Climate Controls

Passenger side temperature selection

To control the temperature, select any temperature between 19° C (65° F) and 29° C (85° F) by pressing the temperature control on the passenger side of the system.

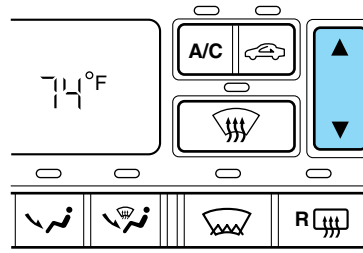

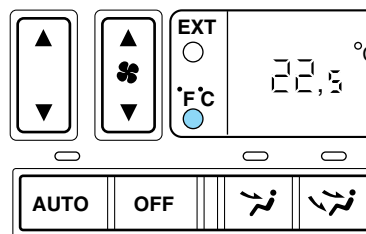

Temperature conversion

Press the Fahrenheit/Celsius (°F °C) control to switch between Fahrenheit and Celsius temperature on the DATC display only. The set point temperatures in Celsius will be displayed in half-degree increments.

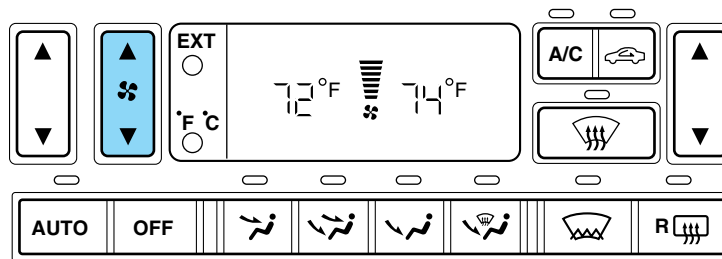

Fan speed ()



When AUTO is pressed, fan speed is adjusted automatically for existing conditions. You can override fan speed at any time. To control fan speed manually, press the fan control to cancel the automatic fan speed operation. Press the control up for higher fan speed or down for lower fan speed. The display will show  and a bar graph to indicate manual fan speed operation and relative speed.

Climate Controls

When the fan is adjusted in the AUTO mode, the AUTO indicator will remain lit and the system will remain in auto operation.

To return to automatic fan operation, press AUTO. The fan icon and bars will disappear from the display, and the DATC system will return to full automatic operation.

- **A/C control**

 (air conditioning) — Used to manually enable or disable the operation of the air conditioning in all modes except defrost. In all modes, the air conditioning will only function if the outside temperature is about 2°C (35°F) or higher. When manual A/C is selected (ON) the indicator will be lit. When manual A/C is selected (OFF) the indicator will not be lit.

In defrost and floor/defrost mode, if the outside temperature is about 2°C (35°F) or higher, the air conditioner will automatically dehumidify the air to reduce window fogging. However, the A/C indicator will be off and the A/C override control cannot be selected.

When AUTO is selected, the A/C operates automatically for existing conditions. With automatic A/C operation, the A/C indicator will be lit if the outside temperature is about 2°C (35°F) or higher. You may override the automatic A/C operation at any time. To manually control the A/C operation and cancel automatic A/C operation, press the A/C control. When the A/C is manually controlled in the AUTO mode, the AUTO indicator will remain lit. To return to automatic A/C operation, press AUTO.

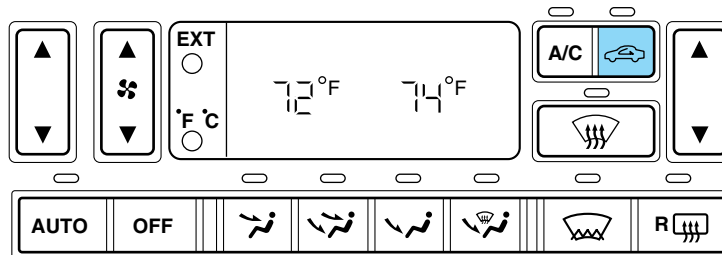

- **Recirculation control**

 (air recirculation) — Used to manually enable or disable the operation of the recirculated air operation in all modes except defrost. The use of recirculated air when the air conditioning is operating helps to reduce the amount of time to cool down the interior of the vehicle in

Climate Controls

very hot conditions. Recirculated air may also help to keep undesired outside odors from reaching the vehicle interior. It is recommended to allow the DATC system to automatically control the selection of outside or recirculated air.

The recirculation control cannot be selected in the defrost mode, as interior fogging may occur.

In floor and floor/defrost modes, the DATC system will automatically return to outside air to help reduce window fogging. When the recirculation air control is selected, the amount of time in manual recirculated air depends on the ambient temperature.

When AUTO is selected, the recirculated air feature operates automatically for existing conditions. You may override the automatic recirculated air operation at any time. To manually control the recirculated air operation and cancel automatic recirculated air operation, press the recirculated air control. When the recirculated air is manually controlled in the AUTO mode, the AUTO indicator light will remain lit. To return to full automatic recirculated air operation, press AUTO.

Do not leave the DATC system in recirculated air operation for extended periods of time while the system is in a heating mode or in cold/damp conditions as this may cause interior fogging of the front, side and rear windows.

Manual override controls

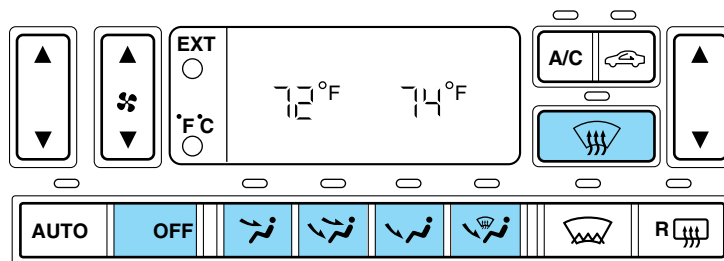

The manual override controls allow you to manually determine where airflow is directed. To return to fully automatic control, press AUTO.

When a manual airflow override control is selected, the DATC system will turn off the AUTO indicator and display the indicators of all operating override controls. More than one override control indicator may turn on when an override control is selected.

Climate Controls

The air conditioning compressor can operate in all modes except OFF. However, the air conditioning will only function if the outside temperature is about 2°C (35°F) or higher.

Since the air conditioner removes considerable moisture from the air during operation, it is normal if clear water drips on the ground under the air conditioner drain while the system is working and even after you have stopped the vehicle.

- **Airflow direction control**

 (panel) — Distributes air through the instrument panel.

 (panel/floor) — Distributes air through the instrument panel and the front floor ducts. For added customer comfort, the air distributed through the floor ducts may be slightly warmer than the air sent to the instrument panel registers.

 (floor) — Distributes air through the front floor ducts. The system will allow some airflow out the defroster ducts, the demister outlets and outer instrument panel registers.

 (floor/defrost) — Distributes air through the windshield defroster ducts, the demister outlets and the front floor ducts. The system will allow some airflow out of the outer instrument panel registers. For added customer comfort, the air distributed through the floor ducts may be slightly warmer than the air sent to the windshield defroster ducts. If the outside temperature is about 2°C (35°F) or higher, the air conditioner will automatically dehumidify the air to reduce window fogging. (Note that the A/C indicator does not illuminate when this mode is selected.) Recirculation and A/C override controls can be selected.

 (defrost) — Distributes outside air through the windshield defroster ducts and the demister outlets. It can be used to clear ice or fog from the windshield. The system will allow some airflow out of the outer instrument panel registers. If the outside temperature is about 2°C (35°F) or higher, the air conditioner will automatically dehumidify the air to reduce window fogging. Recirculation and A/C override controls cannot be selected. **Note that the A/C indicator does not illuminate when this mode is selected.**

- **Turn DATC off**

OFF-Outside air is kept out. The fan, heating and air conditioning will not operate. The outside temperature will still display when selected with the ignition in the RUN position.

Climate Controls

Electric window heaters

 (heated wiper rest) — Located at the base of the windshield, this feature heats the front glass area below the area heated by the front defroster where the windshield wipers sit in their parked position. When activated, the feature keeps the wiper blades warm and reduces the chance of ice build up on the blades. The indicator will light when the feature is in operation.

With the ignition in RUN and the engine running, the feature will be automatically enabled if the temperature is below 5°C (40°F). The feature can be manually selected or deselected at any time. However, the automatic feature will be enabled each time the engine is started.

In cold, dry conditions where wet snow or ice is not present it is acceptable to manually deselect the operation of this feature.

The feature will run continuously unless a low battery condition is detected, or unless the feature is manually deselected, and will only activate when the vehicle engine is running (to prevent excessive drain of the vehicle battery).

 (rear window defroster) — Refer to *Rear Window Defroster*.

Displaying outside temperature

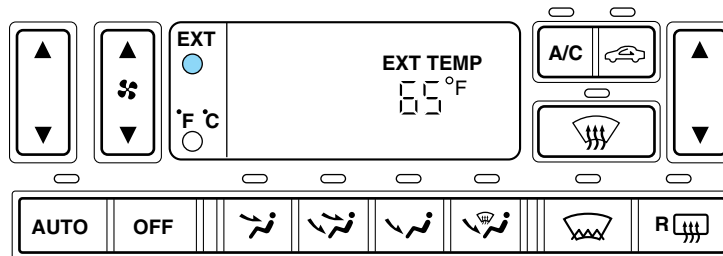

Press EXT to display the outside air temperature. It will remain selected until the EXT control is pressed again.

If the driver or passenger temperature or the fan speed is changed, or the AUTO or  modes selected while the outside temperature is displayed, the driver and passenger temperature display will be displayed for 4 seconds. Following this, the outside temperature display will return to the window.



If the outside temperature is displayed while the DATC system is in the OFF mode and the DATC is turned on, the driver and passenger

Climate Controls

temperatures will be displayed for 4 seconds. Following this, the outside temperature display will return to the window.

The outside temperature reading is most accurate when the vehicle is moving. Higher readings may be obtained when the vehicle is not moving. The readings may not agree with temperatures given on the radio due to differences in vehicle and station locations.

Operating tips

- In humid weather, select  and  before driving. This will reduce fogging on your windshield. After a few minutes, select any desired position.
- To prevent humidity buildup inside the vehicle, don't drive with the climate control system in the OFF position.
- DO NOT leave the DATC system in recirculated air mode for extended periods of time while the system is in a heating mode or in cold or damp conditions as this may cause interior fogging of the front, side and rear windows.
- Do not place objects under the front seat that will interfere with the airflow.
- Remove any snow, ice or leaves from the air intake area at the base of the windshield.
- If your vehicle has been parked with the windows closed during hot weather, the air conditioner will do a much faster job of cooling if you drive for two or three minutes with the windows open. This will force most of the hot, stale air out of the vehicle. Then operate the air conditioner as you would normally.
- If the air conditioner works well with the recirculation feature on, but not in the outside air mode, this may indicate that the cabin air filter needs to be replaced.
- Do not place objects over the defroster outlets. These objects can block airflow and reduce your ability to see through your windshield. Also, avoid placing small objects on top of your instrument panel. These objects can fall down into the defroster outlets and block airflow and possibly damage your climate control system.

Climate Controls

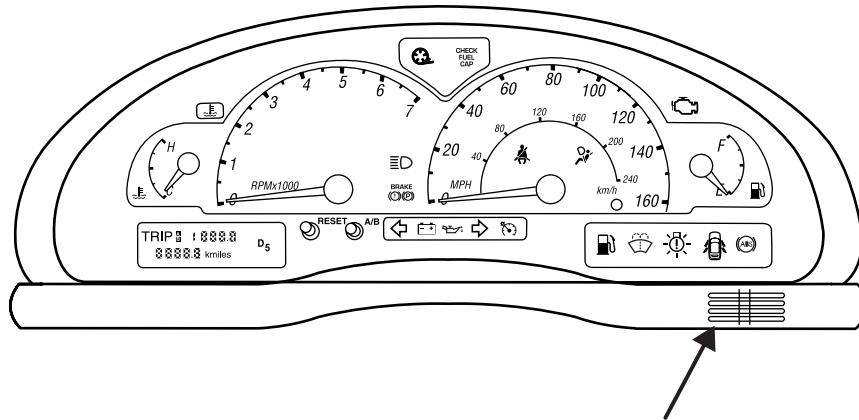

- Do not place items over the climate temperature sensor grid. This may cause improper operation of the DATC system.
- With the ignition in the OFF position after operating the vehicle, some vehicle sounds related to the climate control system may be heard.
- Approximately two minutes after key off, the air distribution doors may adjust their positions as part of the normal operating process.

To aid in side window defogging/demisting in cold weather conditions:

1. Select 
2. Set the temperature control to full heat
3. Select A/C
4. Set the fan speed to High
5. Direct the outer panel vents towards the side windows
6. In order to increase the airflow to the outer panel vents, close the central panel vents.



Do not place objects on top of the instrument panel, as these objects may become projectiles in a collision or sudden stop.

Climate Controls

REAR WINDOW DEFROSTER

Press the rear window defroster control to clear the rear window of thin ice or fog. The indicator will illuminate when the rear window defroster is selected.

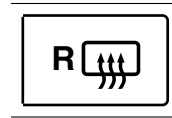

The ignition must be in the RUN position and the engine running in order to operate the rear window defroster.

The rear window defroster turns off automatically after 10 minutes or sooner if a low battery condition is detected, or when the ignition is turned to the OFF position. To manually turn off the rear window defroster before 10 minutes have passed, push the control again.

CABIN AIR FILTER

Your vehicle is equipped with a cabin air filter. This particulate air filtration system is designed to reduce the concentration of airborne particles such as dust, spores and pollen in the air being supplied to the interior of the vehicle. The particulate filtration system gives the following benefits to customers:

- Improves the customer's driving comfort by reducing particle concentration
- Improves the interior compartment cleanliness
- Protects the climate control components from particle deposits

The filter is located just in front of the windshield under the cowl grille on the passenger side of the vehicle.

For more information, or to replace the filter, contact your Ford, Lincoln or Mercury Dealer.

MASTER LIGHTING SWITCH

Rotate the headlamp control to the first position to turn on the parking lamps.

Rotate to the second position to turn on the headlamps.

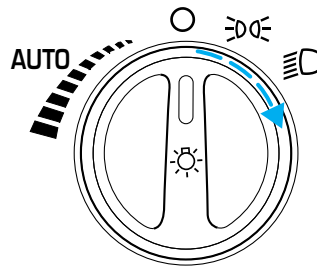

Autolamp control

The autolamp system provides light sensitive automatic on-off control of the exterior lights normally controlled by the master lighting switch.

The autolamp system also keeps the lights on for a preselected period of time after the ignition switch is turned to OFF.

- To turn autolamps on, rotate the control counterclockwise. The preselected time lapse is adjustable up to approximately three minutes by continuing to rotate the control counterclockwise.
- To turn autolamps off, rotate the control clockwise to OFF.

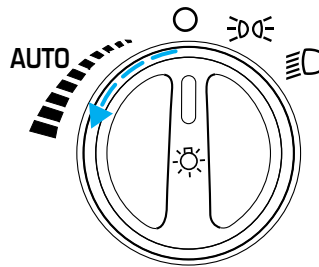

Daytime running lamps (DRL) (Canada Only)

Turns the lowbeam headlamps on with a reduced output.

To activate with automatic transmission:

- the ignition must be in the RUN position;
- the headlamp control is in the OFF position, Parking lamps position, or Autolamp position when the autolamp function has not turned on the headlamps (daytime); and
- the transmission is out of Park.

Lights

 Always remember to turn on your headlamps at dusk or during inclement weather. The Daytime Running Light (DRL) System does not activate your tail lamps and generally may not provide adequate lighting during these conditions. Failure to activate your headlamps under these conditions may result in a collision.

High beams

Pull toward you until control stops to activate. Repeat to deactivate.

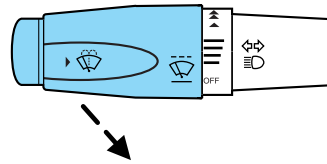

Flash to pass

Pull toward you slightly to activate and release to deactivate.

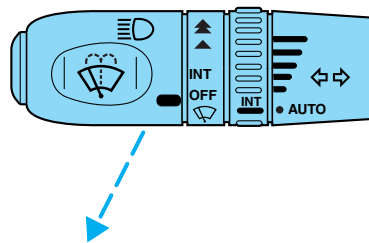

PANEL DIMMER CONTROL

Use to adjust the brightness of the instrument panel during parklamp, headlamp and autolamp operation.

- Rotate up to brighten.
- Rotate down to dim.
- Rotate fully up to turn on the interior lights.

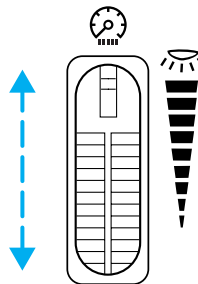

HEADLAMP VERTICAL AIM ADJUSTMENT

1. Park the vehicle on a level surface approximately 7.6 meters (25 feet) from a vertical wall or screen directly in front of it.

- (1) Eight feet
- (2) Center height of lamp to ground
- (3) Twenty five feet
- (4) Horizontal reference line

2. Measure the height from the center of your headlamp to the ground and mark a 2.4 meter (8 foot) horizontal reference line on the vertical wall or screen at this height (a piece of masking tape works well). The center of the lamp is marked by a 3.0 mm circle on the headlamp lens.

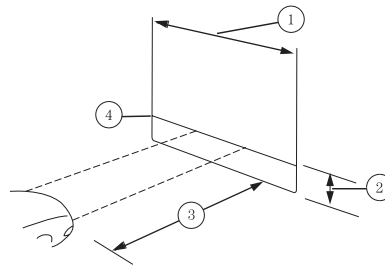

3. Turn on the low beam headlamps to illuminate the wall or screen and open the hood.

4. On the wall or screen you will observe a light pattern with flat edges at the top of the beam pattern. If the flat edges are not at the horizontal reference line, the beam will need to be adjusted.

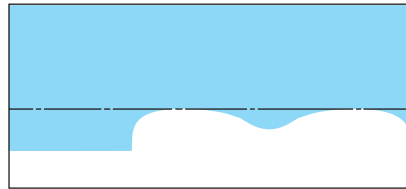

5. Locate the vertical adjuster on each headlamp, then use a 6 mm allen wrench or screwdriver to adjust the headlamp up or down.

6. HORIZONTAL AIM IS NOT REQUIRED FOR THIS VEHICLE AND IS NON-ADJUSTABLE.

7. Close the hood and turn off the lamps.

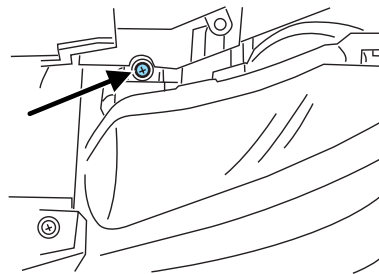

Lights

TURN SIGNAL CONTROL ⇐⇒

- Push down to activate the left turn signal.
- Push up to activate the right turn signal.

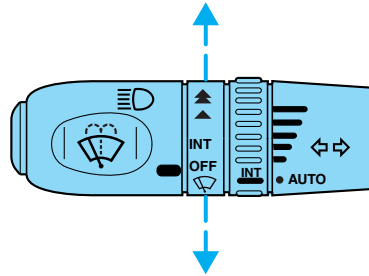

INTERIOR LAMPS

Map lamps

The map lamps and controls are located on the rearview mirror. Press the controls on the bottom of the mirror to activate the lamps.

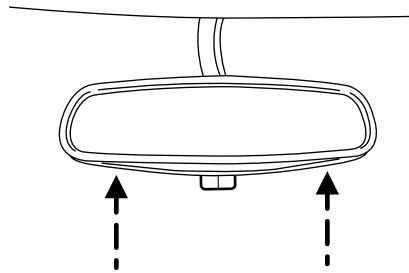

BULBS

Replacing exterior bulbs

Check the operation of the following lamps frequently:

- Headlamps
- Tail lamps
- Brakelamps
- High-mount brakelamp
- Turn signal lamps
- Supplemental parking lamps
- Front/rear side marker lamps
- Backup lamps
- License plate lamp

Do not remove lamp bulbs unless they will be replaced immediately. If a bulb is removed for an extended period of time, contaminants may enter the lamp housings and affect performance.

Lights

Using the right bulbs

Replacement bulbs are specified in the chart below. Headlamp bulbs must be marked with an authorized "D.O.T." for North America and an "E" for Europe to assure lamp performance, light brightness, pattern and safe visibility. The correct bulbs will not damage the lamp assembly or void the lamp assembly warranty and will provide quality bulb burn time.

Function	Number of bulbs	Trade number
Park/turn lamps (front)	2	3457 AK (amber)
Supplemental parking lamps (if equipped)	2	912
Front side marker lamps	4	194
Rear side marker lamps	2	194
Headlamps	2	9007
Rear stop/turn/tail lamps	2	3157K
Backup lamps	2	3156K
Rear license plate lamps	2	168
High-mount brake lamp	See a dealer or qualified technician	
Footwell courtesy lamps	2	168
Map lamps	2	575
Glove box lamp	1	168
To replace all instrument panel lights - see your dealer.		

Interior bulbs

Check the operation of the following interior bulbs frequently:

- front map lamps

For bulb replacement, see a dealer or qualified technician.

Lights

Replacing headlamp bulbs

To remove the headlamp bulb:

1. Make sure headlamp switch is in OFF position, then open the hood.
2. Pry up the two retainer pins to release the headlamp assembly from the vehicle.
3. Remove the screw from the back of the headlamp and pull headlamp forward.

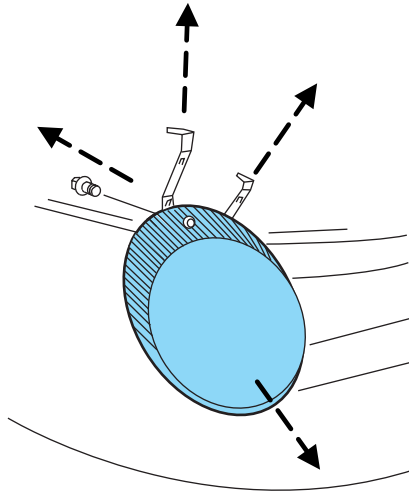

4. Disconnect the electrical connector from the bulb by pulling rearward.

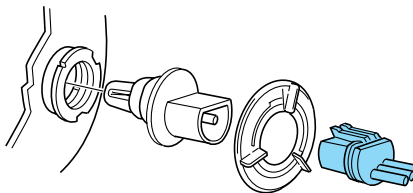

5. Remove the bulb retaining ring by rotating it counterclockwise (when viewed from the rear) to free it from the bulb socket, and slide the ring off the plastic base. Keep the ring to retain the new bulb.

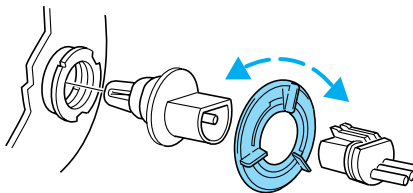

Lights

6. Without turning, remove the old bulb from the lamp assembly by pulling it straight out of the lamp assembly.

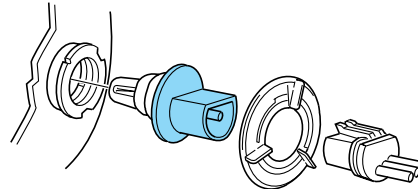

To install the new bulb:



Handle a halogen headlamp bulb carefully and keep out of children's reach. Grasp the bulb only by its plastic base and do not touch the glass. The oil from your hand could cause the bulb to break the next time the headlamps are operated.

Note: If the bulb is accidentally touched, it should be cleaned with rubbing alcohol before being used.

1. With the flat side of the new bulb's plastic base facing upward, insert the glass end of the bulb into the lamp assembly. Turn the bulb left or right to align the grooves in the plastic base with the tabs in the lamp assembly. When the grooves are aligned, push the bulb into the lamp assembly until the plastic base contacts the rear of the lamp assembly.
2. Install the bulb retaining ring over the plastic base and lock the ring by rotating clockwise until it snaps into place.
3. Connect the electrical connector to the bulb.
4. Install the headlamp on vehicle by aligning the lamp on the vehicle, push rearward to fully seat the lamp assembly and install the screw on the headlamp.
5. Push the two retainer pins down.
6. Turn the headlamps on and make sure they work properly. If the headlamp was correctly aligned before you changed the bulb, you should not need to align it again.

Lights

Replacing front parking lamp/turn signal bulbs

1. Make sure headlamp switch is in OFF position, then open the hood.
2. Pry up the two retainer pins to release the headlamp assembly from the vehicle.
3. Remove the screw from the back of the headlamp and pull headlamp forward.

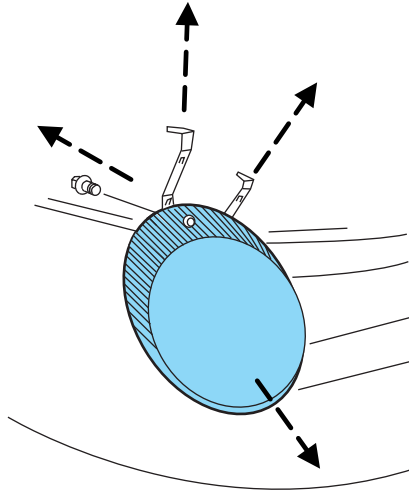

4. Rotate bulb socket counterclockwise and remove from lamp assembly.
5. Carefully pull bulb straight out of socket and push in the new bulb.
6. Install bulb socket in lamp assembly by turning clockwise.
7. Install the headlamp on vehicle by aligning the lamp on the vehicle, push rearward to fully seat the lamp assembly and install the screw on the headlamp.

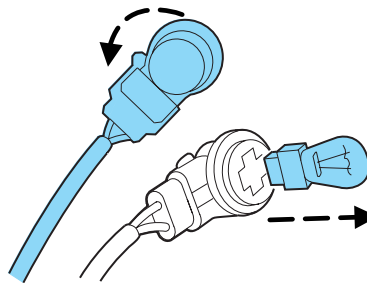

8. Push the two retainer pins down.
9. Turn the lamps on and make sure the new bulb works properly.

Replacing front/rear side marker bulbs

1. Make sure the headlamp switch is in the OFF position and then remove the screw and carefully pull the lamp assembly out from the bumper.

2. Rotate bulb socket counterclockwise and remove from lamp assembly.

3. Carefully pull bulb straight out of socket and push in the new bulb.

4. To complete installation, follow the removal procedure in reverse order.

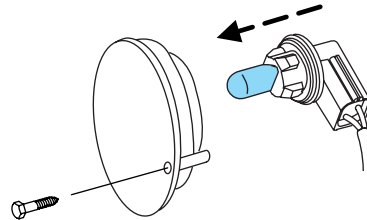

Replacing supplemental parking lamp bulbs (if equipped)

1. Make sure the headlamp switch is in the OFF position and then remove the screw and carefully pull the lamp assembly out from the bumper.

2. Rotate the bulb socket counterclockwise and remove from lamp assembly.

3. Pull the bulb straight out of the socket and push in the new bulb.

4. To complete installation, follow the removal procedure in reverse order.

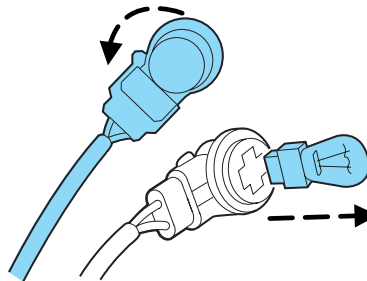

Lights

Replacing tail/brake/turn/backup lamp bulbs

The tail/brake/turn/backup bulbs are located in the tail lamp assembly, one just below the other. Follow the same steps to replace either bulb:

Prior to pulling the carpet away, in step 1, the trunk trim scuff plate must be removed. This can be accomplished by pulling gently on the component until the 6 push pins along the rear of the trunk release. The part can be placed aside and the carpet pulled away. To replace the piece, re-align the pins and push into place.

1. Make sure the headlamp switch is in the OFF position and then open the trunk and carefully pull the carpet away to expose the nut and washer assemblies.

2. Remove the two nut and washer assemblies from the lamp assembly.

3. Pull the lamp assembly towards the rear of the vehicle disengaging the ball stud locator from the ball stud socket in the body. Carefully remove the lamp assembly from the vehicle.

4. Rotate the bulb socket counterclockwise and remove from lamp assembly.

5. Pull the bulb straight out of the socket and push in the new bulb.

6. To complete installation, follow the removal procedure in reverse order.

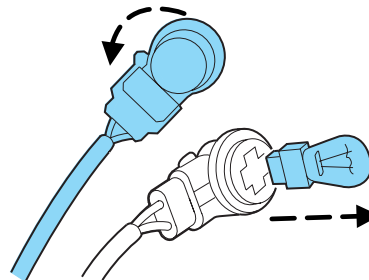
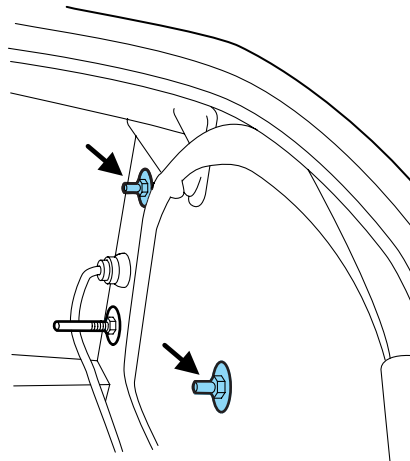

Replacing license plate lamp bulbs

1. Make sure the headlamp switch is in the OFF position and then remove two screws and the license plate lamp assembly from the vehicle.
2. Rotate bulb socket counterclockwise and remove from lamp assembly.
3. Carefully pull the bulb from the socket and push in the new bulb.
4. Install the lamp assembly on liftgate with two screws.

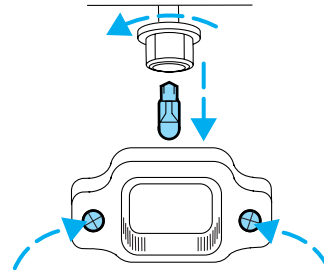

Replacing high-mount brake lamp assembly

For bulb replacement, see a dealer or qualified technician.

Driver Controls

WINDSHIELD WIPER/WASHER CONTROLS

Rotate the windshield wiper control to the desired interval, low or high speed position. The ignition must be in the ACC or RUN position to operate the windshield wiper.

The bars of varying length are for intermittent wipers. When in this position rotate the control upward for fast intervals and downward for slow intervals.

Push the control on the end of the stalk to activate washer. Push and hold for a longer wash cycle. The washer will automatically shut off after ten seconds of continuous use.

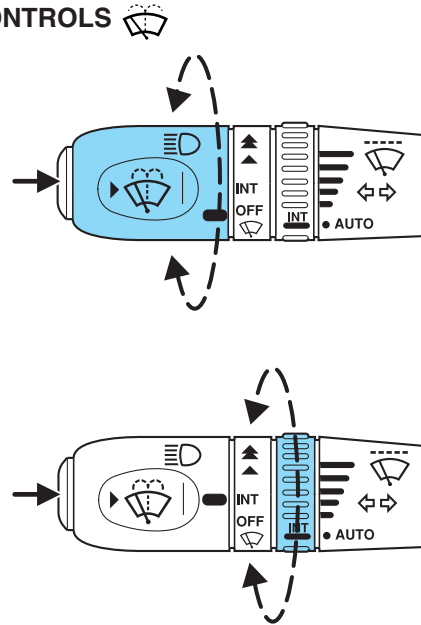

Speed dependent wipers

When the windshield wiper control is set on the intermittent settings, speed-sensitive front wipers automatically adjust as the vehicle's speed changes.

Windshield wiper blades

Check the wiper blades for wear at least twice a year or when they seem less effective. Substances such as tree sap and some hot wax treatments used by commercial car washes reduce the effectiveness of wiper blades.

Checking the wiper blades

If the wiper blades do not wipe properly, clean both the windshield and wiper blades using undiluted windshield wiper solution or a mild detergent. Rinse thoroughly with clean water. To avoid damaging the blades, do not use fuel, kerosene, paint thinner or other solvents.

Driver Controls

Changing the wiper blades

To replace the wiper blades:

1. Pull the wiper arm away from the windshield and lock into the service position.
2. Turn the blade at an angle from the wiper arm. Push the lock pin manually to release the blade and pull the wiper blade down toward the windshield to remove it from the arm.
3. Attach the new wiper to the wiper arm and press it into place until a click is heard.

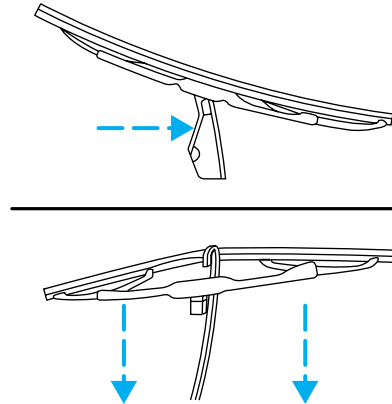

TILT/TELESCOPE STEERING COLUMN

Power tilt/telescope steering column



Never adjust the steering wheel when the vehicle is moving.

The steering column can be adjusted manually by moving the four-way rocker adjustment control located on the multi-function control below the turn signal/wiper control stalk. The control will adjust the column as long as held or until the column reaches the end of travel.

The telescope function is adjusted by moving the control toward the driver to telescope out and moving the control toward the instrument panel to telescope in.

The tilt function is adjusted by moving the control up to tilt up and moving the control down to tilt down.

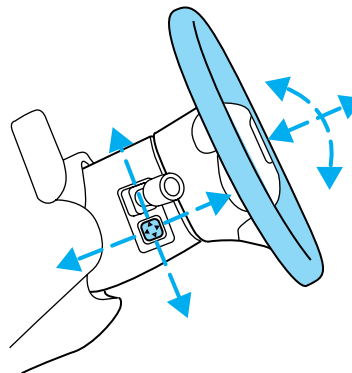

Driver Controls

During easy exit operation, the column will move to the full in and up position. When the key is inserted into the ignition switch, the column will return to the previous setting. When you remove the key, the column will move away.

AUXILIARY POWER POINT 12V

The power point is an additional power source for electrical accessories.

A power point is located on the instrument panel.

Do not use the auxiliary power point as a cigarette lighter.

The use of non-Ford approved electrical accessories could cause damage not covered by your warranty.

Power outlets are designed for accessory plugs only. Do not hang any type of accessory or accessory bracket from the plug. Improper use of the power outlet can cause damage not covered by your warranty.

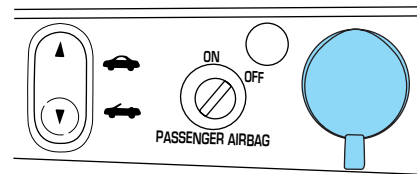

POWER WINDOWS

Press and hold the rocker switches to open and close windows.

- Press the top portion of the rocker switch to close.

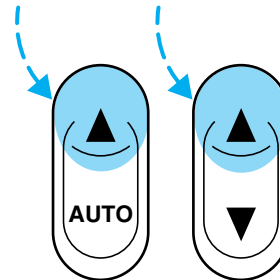

Driver Controls

- Press the bottom portion of the rocker switch to open.

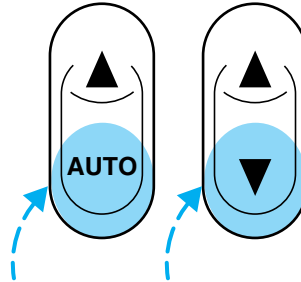

One touch down

- Press AUTO completely down to the second detent. The driver's window will open fully. Depress up to stop window operation.

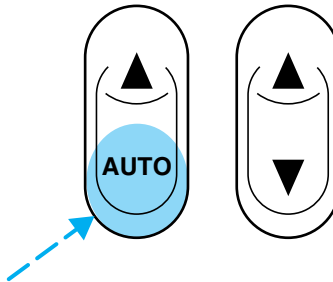

Accessory delay

With accessory delay, the window switches, radio, and the convertible top motor, may be used for up to ten minutes after the ignition switch is turned to the OFF position or until either front door is opened.

Short drop glass

In order to improve door efforts and sealing, your vehicle is equipped with short drop glass. This feature lowers the glass when either door is opened. The glass returns to its closed position when the door is closed. If the optional removable top is not installed on your vehicle, this feature will also lower the glass when the convertible top switch is operated. The glass will return to its closed position if the transmission is shifted out of P (Park), or if the opposite door becomes closed.

Driver Controls

Proper operation of the short drop glass requires that the windows be calibrated. **Though your windows will have been calibrated before your vehicle is delivered to you, it is possible for the windows to lose calibration.** If a window loses its calibration, your short drop feature will lower the window, but will not raise it again when the door is closed. To re-calibrate the window, press the up switch to raise the window until it completes its travel and hold the switch down for 2 seconds. Another possible effect of lost calibration is that the feature may not lower the window. To re-calibrate the window in this case, lower the window until it completes its travel and hold the switch down for 2 seconds. Immediately after releasing the window down switch, press the up switch to raise the window until it completes its travel and hold the switch down for 2 seconds.

POWER SIDE VIEW MIRRORS

The power mirrors can be operated at any time.

To adjust your mirrors:

1. Select L to adjust the left mirror or R to adjust the right mirror.

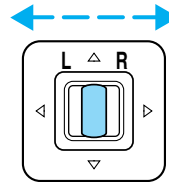

2. Move the control in the direction you wish to tilt the mirror.

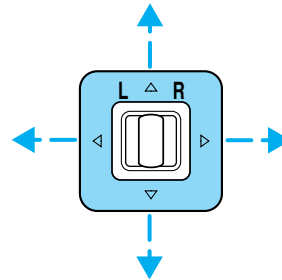

3. Return to the center position to lock mirrors in place.

Driver Controls

LOCKABLE AND ELECTRONIC TRUNK REMOTE CONTROL

The remote trunk release control is located on the driver's door trim panel and can be operated at any time, except when the security system is armed. This control will not work until the vehicle is disarmed.

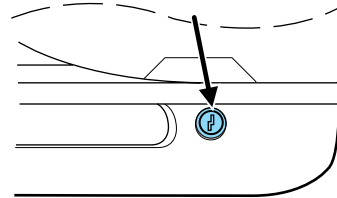

You can render the switch inoperable by locking the button with your master key.

In the event of battery failure, you can open the trunk by using your master key on the key cylinder **located behind the driver's seat.**

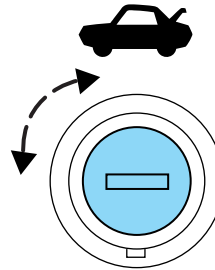

SPEED CONTROL

To turn speed control on

- Press ON.

Vehicle speed cannot be controlled until the vehicle is traveling at or above 48 km/h (30 mph).

Do not shift the gearshift lever into N (Neutral) with the speed control on.

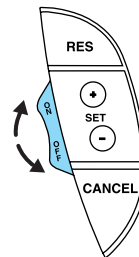

 Do not use the speed control in heavy traffic or on roads that are winding, slippery, or unpaved.

Driver Controls

To turn speed control off

- Press OFF or
- Turn off the vehicle ignition.

Once speed control is switched off, the previously programmed set speed will be erased.

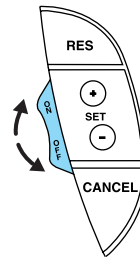

To set a speed

- Press SET+ / SET-. For speed control to operate, the speed control must be ON and the vehicle speed must be greater than 48 km/h (30 mph).

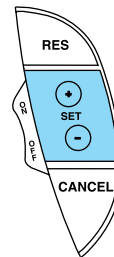

If you drive up or down a steep hill, your vehicle speed may vary momentarily slower or faster than the set speed. This is normal.

Speed control cannot reduce the vehicle speed if it increases above the set speed on a downhill. If your vehicle speed is faster than the set speed while driving on a downhill, you may want to shift to the next lower gear or apply the brakes to reduce your vehicle speed.

If your vehicle slows down more than 16 km/h (10 mph) below your set speed on an uphill, your speed control will disengage. This is normal. Pressing RES will re-engage it.



Do not use the speed control in heavy traffic or on roads that are winding, slippery, or unpaved.

Driver Controls

To set a higher set speed

- Press and hold SET+. Release the control when the desired vehicle speed is reached or
- Press and release SET + to operate the Tap-Up function. Each press will increase the set speed by 1.6 km/h (1 mph) or
- Accelerate with your accelerator pedal. When the desired vehicle speed is reached, press and release SET +.

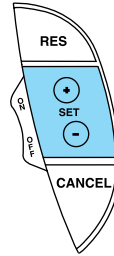

You can accelerate with the accelerator pedal at any time during speed control usage. Releasing the accelerator pedal will return your vehicle to the previously programmed set speed.

To set a lower set speed

- Press and hold SET -. Release the control when the desired speed is reached or
- Press and release SET - to operate the Tap-Down function. Each press will decrease the set speed by 1.6 km/h (1 mph) or
- Press CANCEL or depress the brake pedal. When the desired vehicle speed is reached, press SET + / SET -.

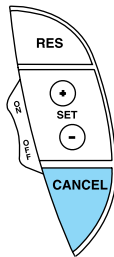
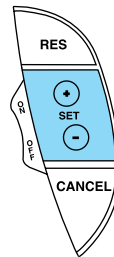

Driver Controls

To disengage speed control

- Press CANCEL, or

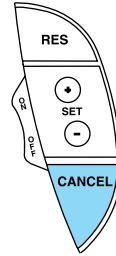

- depress the brake pedal.

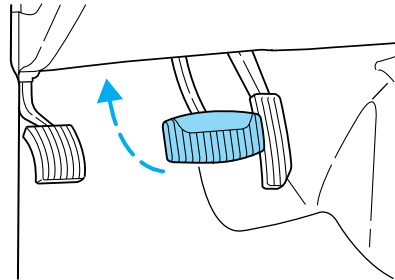

Disengaging the speed control will not erase the previously programmed set speed.

Pressing OFF will erase the previously programmed set speed.

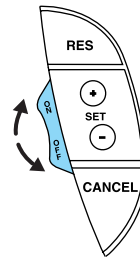

Driver Controls

To return to a previously set speed

- Press RESUME. For RESUME to operate, the vehicle speed must be faster than 48 km/h (30 mph).

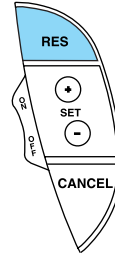

Indicator light

This light comes on when the vehicle speed control is engaged and actively controlling vehicle speed.

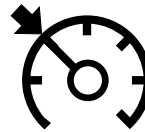

STEERING WHEEL CONTROLS

These controls allow you to operate some audio control features.

Audio control features

Press MEDIA to select AM, FM1, FM2, TAPE, or CD (if equipped).

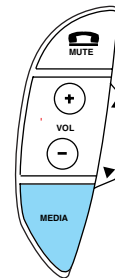

Driver Controls

In AM, FM1, or FM2 mode:

- Press Δ or ∇ to select preset stations within the selected radio band.

In Tape mode:

- Press Δ or ∇ to select the next selection on the tape.

In CD mode:

- Press Δ or ∇ to select the next selection on the CD.

In any mode:

- Press VOL + or - to adjust volume.

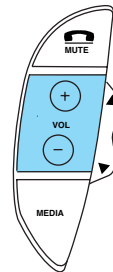
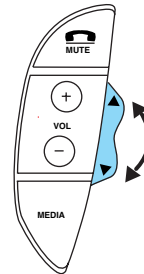

Press the PHONE/MUTE control to mute the playing media. Press again to return to the playing media.

If your vehicle is equipped with a factory installed cellular phone, refer to the *Phone/Mute Mode* section of the *Audio* chapter.

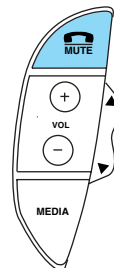

CONVERTIBLE

Articles stored in the convertible top stowage compartment may break the rear glass window when the top is lowered.

Lowering the convertible top

The convertible top can be lowered with the side windows either up or down.

Driver Controls

Do not lower the top when the top material is wet.

If you raise and lower the convertible top several times in a row, the motor will heat up, causing the thermal circuit breaker to open so that the top will stop operating. The convertible top will operate again after allowing the motor to cool several minutes.

To lower the convertible top:

1. Bring vehicle to a complete stop. Put the gearshift in the P (Park) position.

The convertible top will operate with the key in the RUN position, RUN/ACC position or in the accessory delay mode. It is recommended that the vehicle's engine is running when lowering the top to prevent draining the battery.

2. Check the convertible top stowage compartment behind the seat to be sure it is empty and ready to receive the top.

3. Press the button on the convertible top handle and pull the handle down and forward to release the clamps from the windshield header.

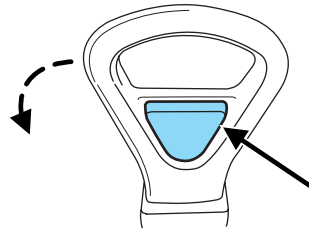

4. Push the convertible top ▼ switch on the instrument panel and hold until the top is completely stored in the stowage compartment.

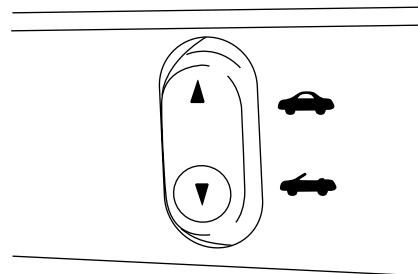

5. Push the handle back into the lock position.

Installation of the tonneau cover

Be sure the cover is tucked into the deck lid and all snaps are fastened before driving.

Driver Controls

1. Push boot rearward and engage boot under the upper back panel at the rear and the quarter panel along the sides.

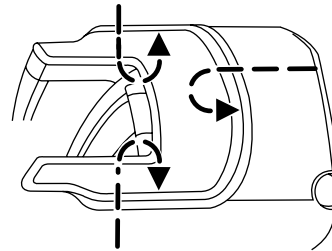

2. Fasten the snaps on boot to the quarter trim panel on both sides of the vehicle and at the center.

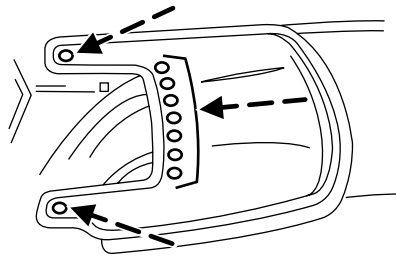

3. To remove unfasten the snaps.
4. Pull forward and lift off.

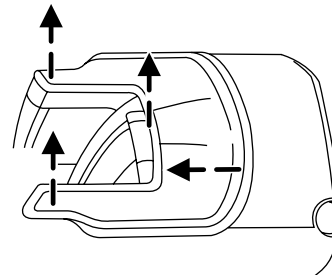

Raising the convertible top

To raise the convertible top:

1. Bring the vehicle to a complete stop. Put the vehicle in the P (Park) position.

The convertible top will operate with the key in the RUN position, RUN/ACC position or in the accessory delay mode. It is recommended that the vehicle's engine is running when raising the top to prevent draining the battery.

Driver Controls

2. Remove the tonneau cover and store it in the luggage compartment.
3. Push the two screws down into the windscreen panel of your vehicle.

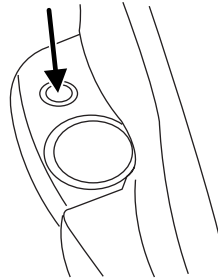

4. Push the convertible top ▲ switch, holding it until the top unfolds and moves forward toward the windshield header.

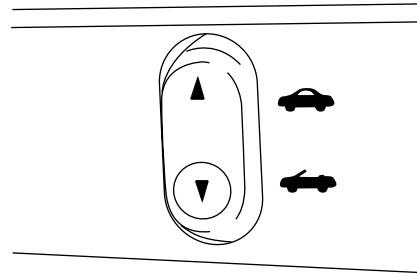

5. Press the button on the convertible top handle and pull the handle down to open both top clamps before the top meets the windshield header.

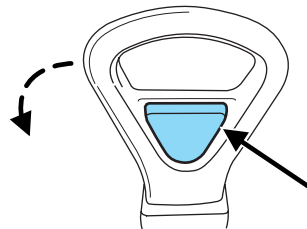

6. Resume pushing the convertible top switch until it has reached the fully closed position flush to the header.
7. The two pins under the forward edge of the top should seat themselves in the matching holes in the header.

Driver Controls

8. To fasten both clamps securely, push the clamp handles into the header on the top until they are flush with the header. Pulling down on the header at the center grip while closing the latches may assist in fastening the clamps. Use the pull cups located on either side of the convertible top handle.

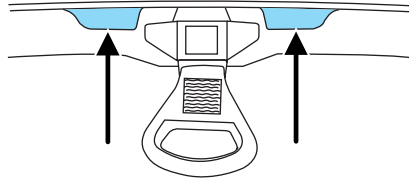

9. Push the convertible top handle back up so that it locks into position.

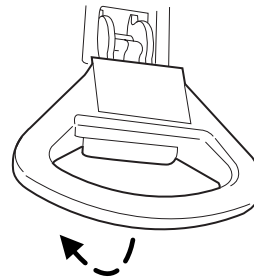

Prolonged storage

It may be difficult to pull down and latch the convertible top after prolonged storage with the top in the down position over the winter or in colder temperatures. This difficulty will decline over time with warmer temperatures and the convertible top in the full up or latched position.

Convertible top and padded molding care

To avoid damage to the cloth top and moldings, use only an approved Ford cleaner, or equivalent. Do not use abrasive material or cleaners.

Hot waxes applied by automatic car washes can affect the cleanability of cloth material.

Using high water pressure or wand type car washes against the convertible top and windows may cause water leaks and possible seal damage.

Driver Controls

REMOVABLE TOP (IF EQUIPPED)

For more information see the CD Rom included with this guide.

Installing the removable top



The front screw fittings must be checked to see that they are firmly seated after driving a distance of approximately 50 to 60 km (30 to 40 miles).



The removable top does not have the same crush resistance as an integrated steel roof in case of collision or rollover.



The removable top is not, under any circumstances, to be used to carry or support external loads.



Movement of the removable top requires at least two people. The removable top weighs approximately 38 kg (84 lb). Also, due to its shape, the weight is biased to the rear of the removable top.



Your vehicle must be turned OFF and placed in PARK on a level surface prior to installing or removing the top.

Before installing the removable top, unsnap and properly store the convertible top tonneau cover. Refer to *Installation of the tonneau cover* in the *Convertible* section. Also, thoroughly dry the convertible top and then lower. Open the doors, lower the windows, and clean the area where the removable top mounts on the body.

1. Remove the protective cover from the top. Using a mild detergent, clean the weather-strips on the top before installing it on the vehicle.
2. Ensure that the removable top levers are rotated rearward to the fully open position. Lock the wheels on the storage cart, loosen the restraining straps on the cart, and with the help of at least another person remove the top from the cart.

Driver Controls

Once per year, apply a small amount of silicone lubricant, F5AZ-19553-AA, to the receivers as shown. The lubricant should be sprayed directly into the hole to avoid contaminating the trim parts.

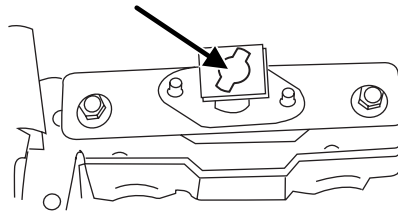

3. Lower the rear of the top into position so that the pins are placed into the bracket receivers.

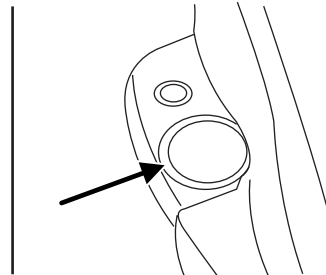
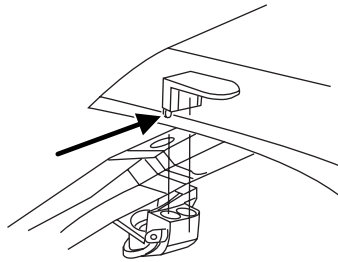
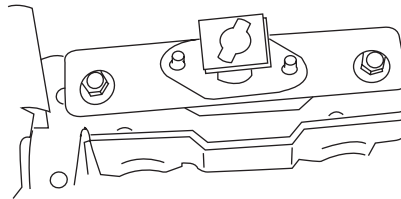

4. Position the front of the top so that the locating tabs on each side are placed in the mounting castings. Ensure that the weather-strip on the top is placed on the body mounted seal without any wrinkles or gaps. The joint should have a smooth and continuous transition to prevent water leaks.

5. Take the mounting key from the bag located in the trunk.

Driver Controls

6. Partially turn, 1/2 turn forward, the levers of the top (located in the rear on the left and right-hand side of the vehicle).

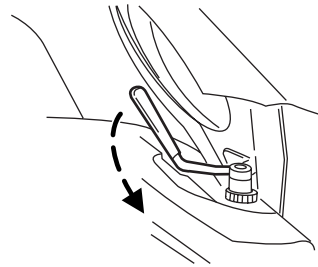

7. Using the mounting key, loosely screw in the two screws at the front of the top by two or three turns. The two screws are already located in the windscreen panel of your vehicle.

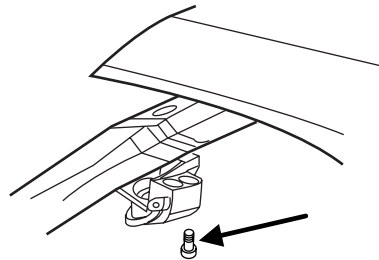

8. Turn and lock the levers fully forward. The levers are locked when you feel the spring engage and the levers are pointing toward the front of the vehicle.

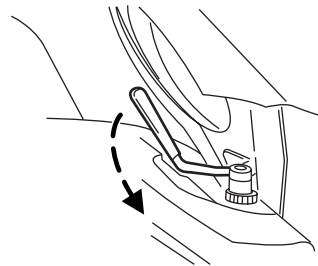

9. Using the mounting key, finish tightening the screws at the front of the removable top all the way so that they are secure.



The front screw fittings must be checked to see that they are firmly seated after a distance of approximately 50 to 60 km (30 to 40 miles).

Driver Controls

Removing the top

It is recommended that you prepare the storage rack before removing the top. See *Removable top storage rack* in this section.

1. Take the mounting key from the bag located in the trunk.
2. Using the mounting key, loosen the two screws at the front of the top. The two screws remain undetachable in the windscreen panel of your vehicle.

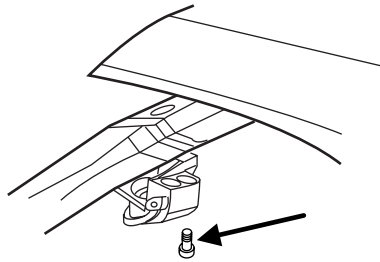

3. Push the two screws down into the windscreen panel of your vehicle.

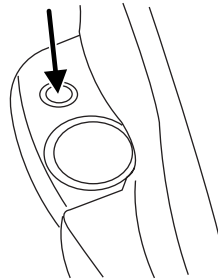

4. Undo the locking levers at the rear right and left sides of the vehicle. Rotate the levers rearward while applying a slight upward force to the top.

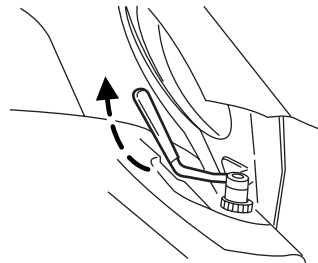

5. With the aid of a second person, lift the top off the vehicle and store it as described in *Removable top storage* in the chapter.

Removable top storage rack

It is recommended that you prepare the storage rack prior to removing the top from the vehicle.

Driver Controls

1. Remove the storage rack from the package and place the bumper end of the uprights on the floor with the wheels facing you.

2. Locate the two chrome locking buttons on each of the two rack legs.

3. Firmly squeeze the two chrome buttons (top and bottom) on one leg and rotate the leg toward you until the leg snaps into place.

4. Squeeze the second set of chrome buttons (top and bottom) for the opposite leg until the leg snaps into place.

5. Turn the rack over on its wheels and place the removable top storage rack on a flat level surface. Make sure the center "T" section is fully locked by attempting to move the section downward without depressing the chrome locking buttons.

6. Lock the two front wheels located on the ends of each of the two rack legs.

7. To lock the wheels, push down on the bottom part of the plastic tab located on the top of each wheel.

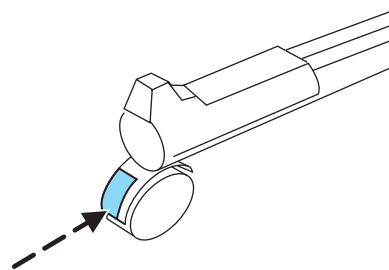
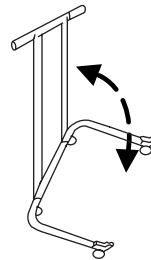
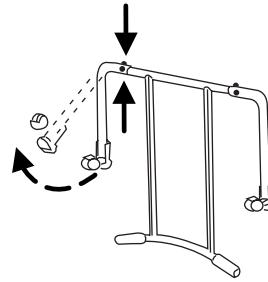

Driver Controls

8. Place the removable top on the storage rack. Make sure the rear edge of the removable top rests on the rubber bumpers of the rack legs. This prevents damage to the painted edge and the weather-strips.

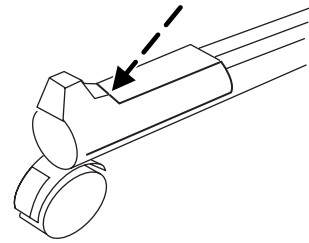

9. Buckle and tighten the retaining strap and unlock the cart wheels before moving the top and cart.

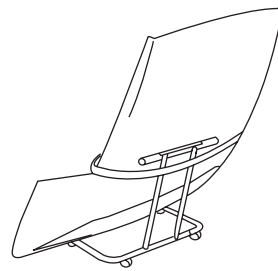

To unlock the wheels, pull up on the lower portion of the plastic tab located on the tip of each wheel.

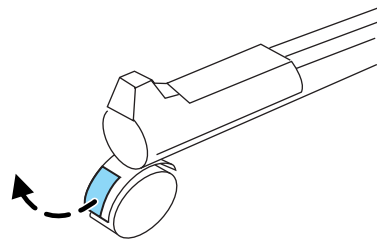

Place the mounting key in a safe place to use again.

Keep your removable top clean by placing the provided cover over it.

If you plan to drive with the convertible top down, ensure all the snaps on the convertible top tonneau cover are fastened and that the rear of the cover is firmly tucked before driving. Refer to *Installation of the tonneau cover* in the *Convertible* section.

Driver Controls

CENTER CONSOLE

Your vehicle may be equipped with a variety of console features. These include:

- Utility compartment
- Cellular phone (if equipped)
- Cupholders
- Ash tray

POSITIVE RETENTION FLOOR MAT

Position the driver floor mat so that the eyelet is over the pointed end of the retention post and rotate forward to lock in. Make sure that the mat does not interfere with the operation of the accelerator or the brake pedal. To remove the floor mat, reverse the installation procedure.

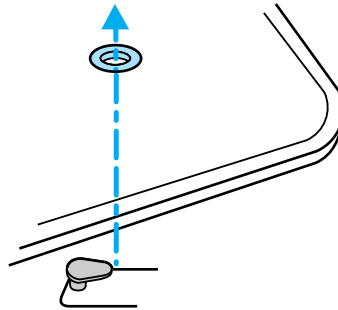

Locks and Security

KEYS

The key operates all locks on your vehicle. In case of loss, replacement keys are available from your dealer.

You should always carry a second key with you in a safe place in case you require it in an emergency.

Refer to *SecuriLock™ Passive Anti-Theft System* for more information.

POWER DOOR LOCKS

Press the top of the control to unlock all doors and the bottom to lock all doors.

When the vehicle's security system is armed, the power door locks and remote trunk release control are disabled; these features will not work until the security system is disarmed.

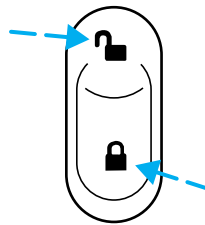

Smart locks

With the key in the ignition, and the driver's door open, the doors cannot be locked using the driver's power door lock switches. If this is attempted, both doors will lock, then the driver's door will immediately unlock.

The vehicle can still be locked, with the key in the ignition, using the manual lock button on the door, operating the remote entry transmitter, or locking the drivers door with the a key.

INTERIOR LUGGAGE COMPARTMENT RELEASE

Your vehicle is equipped with a mechanical interior luggage compartment release handle that provides a means of escape for children and adults in the event they become locked inside the luggage compartment.

Adults are advised to familiarize themselves with the operation and location of the release handle.

Locks and Security

To open the luggage compartment door (lid) from within the luggage compartment, pull the illuminated “T” shaped handle and push up on the trunk lid. The handle is composed of a material that will glow for hours in darkness following brief exposure to ambient light.

The “T” shaped handle will be located either on the luggage compartment door (lid) or inside the luggage compartment near the tail lamps.



Keep vehicle doors and luggage compartment locked and keep keys and remote transmitters out of a child's reach. Unsupervised children could lock themselves in the trunk and risk injury. Children should be taught not to play in vehicles.

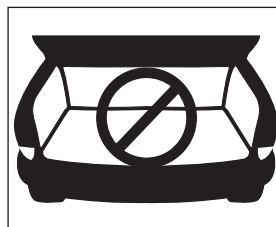

On hot days, the temperature in the trunk or vehicle interior can rise very quickly. Exposure of people or animals to these high temperatures for even a short time can cause death or serious heat-related injuries, including brain damage. Small children are particularly at risk.

REMOTE ENTRY SYSTEM

This device complies with part 15 of the FCC rules and with RS-210 of Industry Canada. Operation is subject to the following two conditions: (1) This device may not cause harmful interference, and (2) This device must accept any interference received, including interference that may cause undesired operation.

Locks and Security

Changes or modifications not expressly approved by the party responsible for compliance could void the user's authority to operate the equipment.

Your remote entry system contains two remote transmitters which provide remote control of several features. Each remote transmitter will allow you to:

- unlock the vehicle doors without a key
- lock all the vehicle doors without a key
- open the trunk without a key
- activate the personal alarm
- arm and disarm the perimeter anti-theft system
- operate the illuminated entry feature

The remote transmitter features only operate with the ignition in the OFF or ACC positions. The remote transmitter features also operate if the ignition is in the RUN position and the gear shift is in P (Park). The personal alarm feature, however, will not operate when the ignition is in the RUN position.

When the vehicle is armed the power door locks and remote trunk release control are disabled. These will not work until the vehicle is disarmed.

If there is any potential remote keyless entry problem with your vehicle, ensure **ALL remote entry transmitters** are brought to the dealership, to aid in troubleshooting.

Locking the doors

Press this control to lock all the doors and arm the perimeter anti-theft system. To confirm all the doors and trunk are closed, the turn signal lamps will display one short flash. Press the control twice within 3 seconds the horn will chirp once, confirming that all doors, hood or trunk are closed. If any of the doors, hood or trunk are open or ajar, the horn will make two quick chirps, reminding you to properly close them.

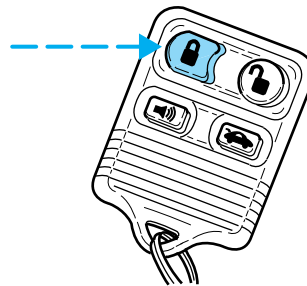

Locks and Security

Unlocking the doors

Press this control to unlock the driver door and disarm the perimeter alarm (if armed). The interior lamps will illuminate.

Press the control a second time within three seconds to unlock all the doors.

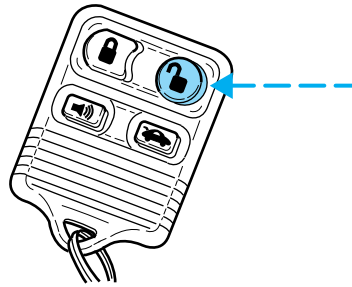

Opening the trunk

Press this control to open the trunk.

Be certain the trunk is closed before driving your vehicle. The trunk may appear closed, but it may not be latched. Failure to do so may cause objects to fall out of the trunk or block rear view vision.

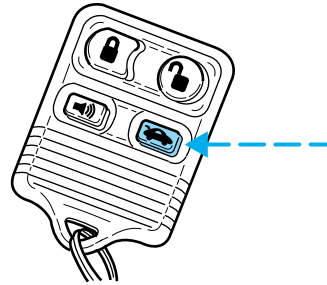

Activating the personal alarm

Press this control to turn on the personal alarm.

Press the control a second time to turn off the personal alarm. The personal alarm will also turn off if the remote transmitter unlock control is pressed, or if the ignition is turned out of the OFF position, or after 2–3 minutes of operation.

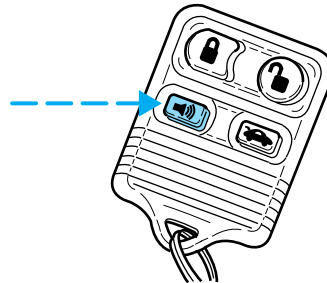

Locks and Security

Replacing the battery

The remote transmitter is powered by one coin type three-volt lithium battery CR2032 or equivalent. Typical operating range will allow you to be up to 10 meters (33 feet) away from your vehicle. A decrease in operating range can be caused by the following factors:

- Weather conditions
- Nearby radio towers
- Structures around the vehicle
- Other vehicles parked next to the vehicle

To replace the battery:

1. Twist a thin coin between the two halves of the transmitter near the key ring. **DO NOT TAKE THE FRONT PART OF THE TRANSMITTER APART.**

2. Place the positive (+) side of new battery in the same orientation. Refer to the diagram inside the transmitter unit.

3. Snap the two halves back together.

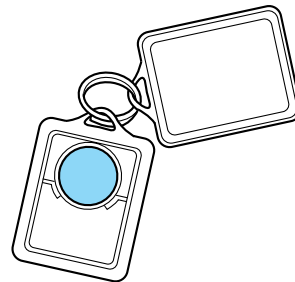

Replacement of the battery will **not** cause the remote transmitter to become deprogrammed from your vehicle. The remote transmitter should operate normally after battery replacement.

Replacing lost transmitters

If a remote transmitter has been lost and you would like to remove it from the vehicle's memory, or you would like to purchase additional transmitters for your vehicle (up to four may be programmed into memory):

- Take **all** your vehicle's transmitters to your dealer for programming, or
- Perform the reprogramming procedure yourself.

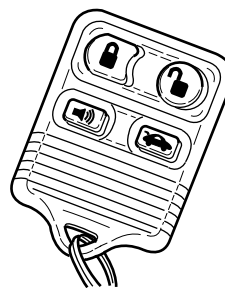

Locks and Security

Reprogramming transmitters

It will be necessary to reprogram **all** the transmitters to the vehicle at the same time while performing this procedure.

To program the transmitter yourself:

1. To reprogram the transmitters yourself, place the key in the ignition and turn from (2) OFF to (4) RUN and cycle between (4) RUN and (2) OFF eight times in rapid succession (within 10 seconds) ending in the (4) RUN position.

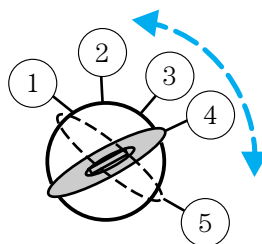

2. After doors lock/unlock, press any control on all transmitters (up to four). With each control press of the transmitters, the door should cycle (lock/unlock) to confirm programming. When completed, turn the ignition to (2) OFF.

3. The door locks should cycle (lock/unlock) one last time to confirm completion of programming.

Illuminated entry

The illuminated entry feature will automatically turn on the interior lamps when the remote transmitter unlock control is pressed.

The illuminated entry feature will automatically turn off the interior lamps if the ignition is turned out of the OFF position, or if the remote transmitter lock control is pressed, or after 25 seconds of illumination.

The interior lamps will not turn off if:

- they have been turned on with the instrument panel dimmer control, or
- any door is open.

The battery saver will turn off the interior lamps 30 minutes after the last door is closed even if the dimmer control is on.

Autolock/Relock

This feature automatically locks all vehicle doors when:

- all doors are closed,
- the engine is running and
- you shift out of P (Park).

Locks and Security

Relock

The autolock feature repeats when:

- the passenger's door is opened then closed while the engine is running, and
- you put the vehicle in motion.

Deactivating/activating the autolock/relock feature

Before following the procedure, make sure that the ignition is OFF and all vehicle doors are closed.

You must complete steps 1-5 within 30 seconds or the procedure will have to be repeated. Wait 30 seconds before repeating the procedure.

1. Turn the ignition key to RUN.
2. Press the power door unlock control three times.
3. Turn the ignition key from RUN to OFF.
4. Press the power door unlock control three times.
5. Turn the ignition back to RUN. The horn will chirp to indicate that you have entered the programming mode.
6. Press the unlock control, then press the lock control. The horn will chirp once if autolock was deactivated or twice (one short and one long chirp) if autolock was activated.
7. Turn the ignition to OFF. The horn will chirp once to confirm the procedure is complete.

SECURILOCK™ PASSIVE ANTI-THEFT SYSTEM

SecuriLock™ passive anti-theft system is an engine immobilization system. This system is designed to prevent the engine from being started unless a **coded key programmed to your vehicle** is used.

The SecuriLock™ passive anti-theft system is not compatible with non-Ford aftermarket remote start systems. Use of these systems may result in vehicle starting problems and a loss of security protection.

THEFT INDICATOR

The theft indicator is the flashing red indicator located on the dash panel.

- When the ignition is in the OFF position, the indicator will flash once every 2 seconds to indicate the SecuriLock™ system is functioning as a theft deterrent.

Locks and Security

- When the ignition is in the ON position, the indicator will glow for 3 seconds to indicate normal system functionality.

If a problem occurs with the SecuriLock[®] system, the indicator will flash rapidly or glow steadily when the ignition is in the ON position. If this occurs, the vehicle should be taken to an authorized dealer for service.

Automatic arming

The vehicle is armed immediately after switching the ignition to the 2 (OFF) position.

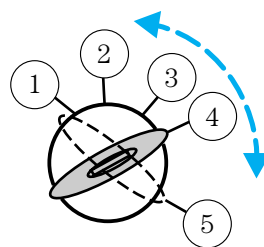

Automatic disarming

Switching the ignition to the 4 (RUN) position with a **coded key** disarms the vehicle. The **THEFT** indicator will illuminate for three seconds and then go out. If the **THEFT** indicator stays on for an extended period of time or flashes rapidly, have the system serviced by your dealership or a qualified technician.

Key information

Your vehicle is supplied with **two coded keys**. Only a **coded key** will start your vehicle.

Spare coded keys can be purchased from your dealership. Your dealership can program your key or you can “do it yourself.” Refer to *Programming spare keys*.

The following items may prevent the vehicle from starting:

- Large metallic objects
- Electronic devices on the key chain that can be used to purchase gasoline or similar items
- A second key on the same key ring as the **coded key**

If any of these items are present, you need to keep these objects from touching the **coded key** while starting the engine. These objects and devices cannot damage the **coded key**, but can cause a momentary “no start” condition if they are too close to the key during engine start. If a

Locks and Security

problem occurs, turn ignition OFF and restart the engine with all other objects on the key ring held away from the ignition key. Check to make sure the **coded key** is an approved Ford **coded key**.

If your keys are lost or stolen you will need to do the following:

- Use your spare key to start the vehicle. or
- Have your vehicle towed to a dealership or a locksmith. The key codes will need to be erased from your vehicle and new key codes will need to be re-coded.

Replacing coded keys can be very costly and you may want to store an extra programmed key away from the vehicle in a safe place to prevent an unforeseen inconvenience.

The correct **coded key** must be used for your vehicle. The use of the wrong type of **coded key** may lead to a “no start” condition.

If an unprogrammed key is used in the ignition it will cause a “no start” condition.

Programming spare keys

A maximum of eight keys can be coded to your vehicle. Only SecuriLock[®] keys can be used. To program a **coded key** yourself, you will need two previously programmed **coded keys** (keys that already operate your vehicle’s engine) and the new unprogrammed key(s) readily accessible for timely implementation of each step in the procedure.

If two previously programmed coded keys are not available, you must bring your vehicle to your dealership to have the spare coded key(s) programmed.

Please read and understand the entire procedure before you begin.

1. Insert the first previously programmed **coded key** into the ignition and turn the ignition from 1 (LOCK) to 4 (RUN) (maintain ignition in 4 (RUN) for at least one second).

2. Turn ignition to 1 (LOCK) and remove the first **coded key** from the ignition.

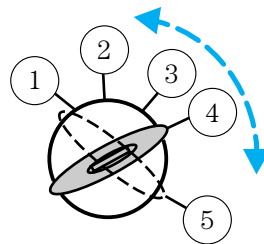

Locks and Security

3. Within ten seconds of turning the ignition to 1 (LOCK), insert the second previously programmed **coded key** into the ignition and turn the ignition from 1 (LOCK) to 4 (RUN) (maintain ignition in 4 (RUN) for at least one second but no more than ten seconds).
4. Turn the ignition to 1 (LOCK) and remove the second **coded key** from the ignition.
5. Within 20 seconds of turning the ignition to 1 (LOCK), insert the new unprogrammed key (new key) into the ignition and turn the ignition from 1 (LOCK) to 4 (RUN) (maintain ignition in 4 (RUN) for at least one second). This step will program your new key to a coded key.
6. To program additional new unprogrammed key(s), repeat this procedure from step 1.

If successful, the new coded key(s) will start the vehicle's engine and the theft indicator will illuminate for three seconds and then go out.

If not successful, the new coded key(s) will not start the vehicle's engine, the theft indicator will flash on and off and you may repeat steps 1 through 6. If failure repeats, bring your vehicle to your dealership to have the new spare key(s) programmed.

PERIMETER ALARM SYSTEM

The perimeter anti-theft system will help protect your vehicle doors, hood and trunk from unauthorized entry.

When the vehicle is armed the power door locks and remote trunk release control are disabled. These will not work until the vehicle is disarmed. Refer to *Driver Controls* chapter for more information.

If there is any potential perimeter anti-theft problem with your vehicle, ensure **ALL remote entry transmitters** are brought to the dealership, to aid in troubleshooting.

Theft indicator

When the perimeter alarm is armed, the theft indicator on the instrument panel will flash briefly every two seconds to indicate the perimeter alarm system is protecting your vehicle.

Locks and Security

Arming the system

When armed, the perimeter alarm will help protect your vehicle from unauthorized entry. When unauthorized entry occurs, the system will flash the turn signal lamps and the theft indicator lamp and will sound the horn.

The system is ready to arm whenever the key is out of the ignition. The system will arm 20 seconds after one of the following actions:

- Press the remote transmitter lock control.
- Open a door and press the power door lock control.

Disarming the system

You can disarm the system by any of the following actions:

- Unlock the doors by using your remote entry transmitter.
- Unlock the driver's door by using your key.
- Turn ignition to RUN.

Seating and Safety Restraints

SEATING

Adjustable head restraints (if equipped)

Your vehicle's seats may be equipped with head restraints which are vertically adjustable. The purpose of these head restraints is to help limit head motion in the event of a rear collision. To properly adjust your head restraints, lift the head restraint so that it is located directly behind your head or as close to that position as possible. Refer to the following to raise and lower the head restraints.

The head restraints can be moved up and down.

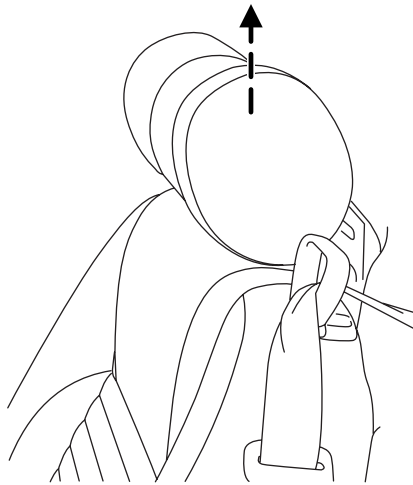

Push control to lower head restraint.

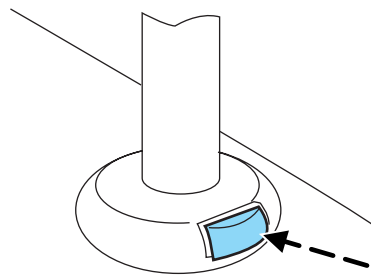

Seating and Safety Restraints

Using the manual lumbar support

The lumbar control is located on the front of the driver's seat cushion.

Turn to adjust lumbar support.

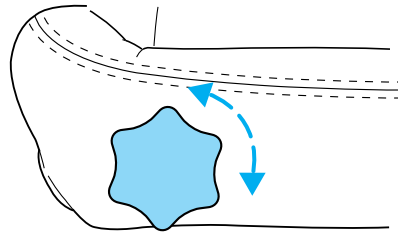

Using the manual recline function (if equipped)



Never adjust the driver's seat or seatback when the vehicle is moving.



The driver and passenger seat must be in the upright position and the lap belt must be snug and low across the hips while the vehicle is moving.

To adjust the front seatback using the manual recliner:

- Lift and hold the handle located on the side of the seat.
- Lean against the seatback to adjust it to your desired position. You can recline the seat back or bring it forward.
- Release the handle when the desired position has been reached.

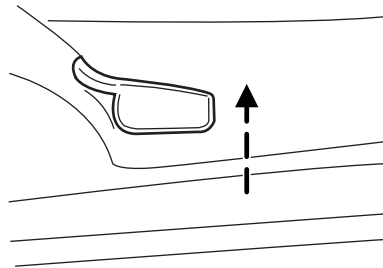

Adjusting the driver's power seat





Never adjust the driver's seat or seatback when the vehicle is moving.



Do not pile cargo higher than the seatbacks to avoid injuring people in a collision or sudden stop.

Seating and Safety Restraints

 The driver and passenger seat must be in the upright position and the lap belt must be snug and low across the hips while the vehicle is moving.

 Reclining the seatback can cause an occupant to slide under the seat's safety belt, resulting in severe personal injuries in the event of a collision.

The seat position control is located on the outboard side of the seat cushion.

Press front to raise or lower the front portion of the seat cushion.

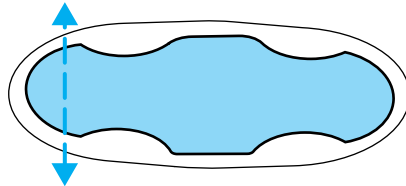

Press rear to raise or lower the rear portion of the seat cushion.

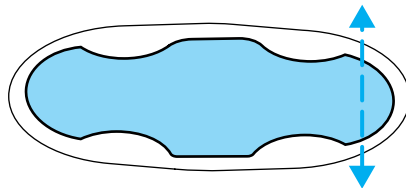

Press the control to move the seat forward, backward, up or down.

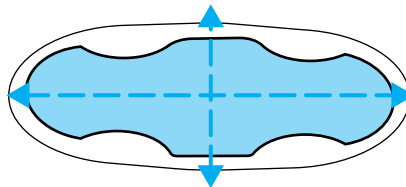

Adjusting the passenger's power seat

 Do not pile cargo higher than the seatbacks to avoid injuring people in a collision or sudden stop.

Seating and Safety Restraints

 The driver and passenger seat must be in the upright position and the lap belt must be snug and low across the hips while the vehicle is moving.

 Reclining the seatback can cause an occupant to slide under the seat's safety belt, resulting in severe personal injuries in the event of a collision.

The control is located on the outboard side of the seat cushion.
Press the control to move the seat forward or backward.

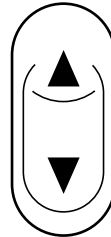



SAFETY RESTRAINTS

Safety restraints precautions

 The driver and passenger seat must be in the upright position and the lap belt must be snug and low across the hips while the vehicle is moving.

 To reduce the risk of injury, make sure children sit where they can be properly restrained.

 Never let a passenger hold a child on his or her lap while the vehicle is moving. The passenger cannot protect the child from injury in a collision.

 All occupants of the vehicle, including the driver, should always properly wear their safety belts, even when an air bag (SRS) is provided.

Seating and Safety Restraints

 It is extremely dangerous to ride in a cargo area, inside or outside of a vehicle. In a collision, people riding in these areas are more likely to be seriously injured or killed. Do not allow people to ride in any area of your vehicle that is not equipped with seats and safety belts. Be sure everyone in your vehicle is in a seat and using a safety belt properly.

 In a rollover crash, an unbelted person is significantly more likely to die than a person wearing a safety belt.

 Each seating position in your vehicle has a specific safety belt assembly which is made up of one buckle and one tongue that are designed to be used as a pair. 1) Use the shoulder belt on the outside shoulder only. Never wear the shoulder belt under the arm. 2) Never swing the safety belt around your neck over the inside shoulder. 3) Never use a single belt for more than one person.

Combination lap and shoulder belts

Before fastening the safety belt, make sure the shoulder belt passes through the belt holder on the top of the seatback.

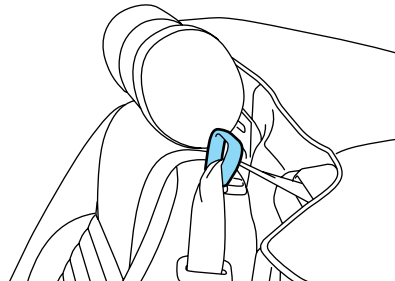

Seating and Safety Restraints

1. Insert the belt tongue into the proper buckle (the buckle closest to the direction the tongue is coming from) until you hear a snap and feel it latch. Make sure the tongue is securely fastened in the buckle.

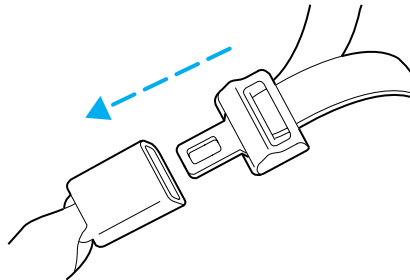

2. To unfasten, push the release button and remove the tongue from the buckle.

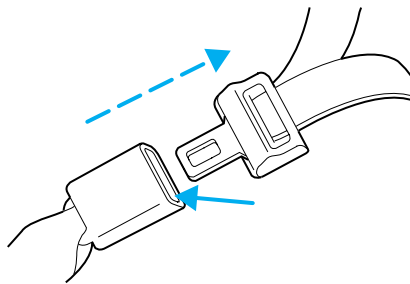

Energy Management Feature

The safety belts in the vehicle are combination lap and shoulder belts.

- This vehicle has a seat belt system with an energy management feature at the front outboard seating positions to help further reduce the risk of injury in the event of a head-on collision.
- This seat belt system has a retractor assembly that is designed to pay out webbing in a controlled manner. This feature is designed to help reduce the belt force acting on the occupant's chest.

 After any vehicle collision, the seat belt system at all passenger seating positions must be checked by a qualified technician to verify that the “automatic locking retractor” feature for child seats is still functioning properly. In addition, all seat belts should be checked for proper function.

Seating and Safety Restraints

 BELT AND RETRACTOR ASSEMBLY MUST BE REPLACED if the seat belt assembly “automatic locking retractor” feature or any other seat belt function is not operating properly when checked according to the procedures in Workshop Manual.

 Failure to replace the Belt and Retractor assembly could increase the risk of injury in collisions.

Vehicle sensitive mode

The vehicle sensitive mode is the normal retractor mode, allowing free shoulder belt length adjustment to your movements and locking in response to vehicle movement. For example, if the driver brakes suddenly or turns a corner sharply, or the vehicle receives an impact of approximately 8 km/h (5 mph) or more, the combination safety belts will lock to help reduce forward movement of the driver and passengers.

Automatic locking mode

How to use the automatic locking mode

- Buckle the combination lap and shoulder belt.

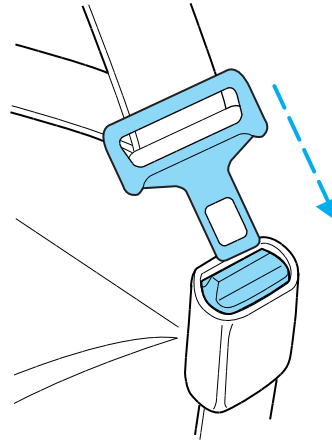

Seating and Safety Restraints

- Grasp the shoulder portion and pull downward until the entire belt is extracted.

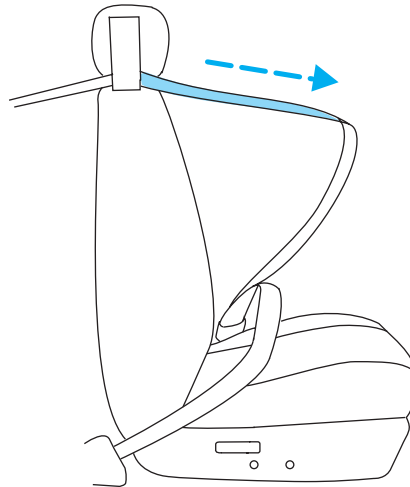

- Allow the belt to retract. As the belt retracts, you will hear a clicking sound. This indicates the safety belt is now in the automatic locking mode.

In this mode, the shoulder belt is automatically pre-locked. The belt will still retract to remove any slack in the shoulder belt.

The automatic locking mode is not available on the driver safety belt.

When to use the automatic locking mode

- **Anytime** a child safety seat is installed in the vehicle. Refer to *Safety Restraints for Children* or *Safety Seats for Children* later in this chapter.

How to disengage the automatic locking mode

Unbuckle the combination lap and shoulder belt and allow it to retract completely to disengage the automatic locking mode and activate the vehicle sensitive (emergency) locking mode.



After any vehicle collision, the combination lap and shoulder belt system at all passenger seating positions must be checked by a qualified technician to verify that the “automatic locking retractor” feature for child seats is still functioning properly, in addition to other checks for proper seat belt system function.

Seating and Safety Restraints



BELT AND RETRACTOR ASSEMBLY MUST BE REPLACED if the seat belt assembly “automatic locking retractor” feature or any other seat belt function is not operating properly. In addition, all seat belts should be checked for proper function.



Failure to replace the belt and retractor assembly could increase the risk of injury in collisions.

Safety belt pretensioner

Your vehicle is equipped with safety belt pretensioners at the driver and front passenger seating positions.

The safety belt pretensioner is a device which removes excess webbing from the safety belt system. The safety belt pretensioner uses the same crash sensor system as the front air bag supplemental restraint system (SRS). When the safety belt pretensioner deploys, webbing from the lap and shoulder belt is tightened. The driver and front passenger seat belt system (including retractors, buckles and height adjusters) must be replaced if the vehicle is involved in a collision that results in deployment of front air bags and safety belt pretensioners. Refer to the *Safety belt maintenance* section in this chapter.



Failure to replace the safety belt assembly under the above conditions could result in severe personal injuries in the event of a collision.

Safety belt warning light and indicator chime

The safety belt warning light illuminates in the instrument cluster and a chime sounds to remind the occupants to fasten their safety belts.

Seating and Safety Restraints

Conditions of operation

If...	Then...
The driver's safety belt is not buckled before the ignition switch is turned to the RUN position...	The safety belt warning light illuminates 1-2 minutes and the warning chime sounds 4-8 seconds.
The driver's safety belt is buckled while the indicator light is illuminated and the warning chime is sounding...	The safety belt warning light and warning chime turn off.
The driver's safety belt is buckled before the ignition switch is turned to the RUN position...	The safety belt warning light and indicator chime remain off.

BeltMinder

The BeltMinder feature is a supplemental warning to the safety belt warning function. This feature provides additional reminders to the driver that the driver's safety belt is unbuckled by intermittently sounding a chime and illuminating the safety belt warning lamp in the instrument cluster.

If...	Then...
The driver's safety belt is not buckled before the vehicle has reached at least 5 km/h (3 mph) and 1-2 minutes have elapsed since the ignition switch has been turned to ON...	The BeltMinder feature is activated - the safety belt warning light illuminates and the warning chime sounds for 6 seconds every 30 seconds, repeating for approximately 5 minutes or until safety belt is buckled.
The driver's safety belt is buckled while the safety belt indicator light is illuminated and the safety belt warning chime is sounding...	The BeltMinder feature will not activate.
The driver's safety belt is buckled before the ignition switch is turned to the ON position...	The BeltMinder feature will not activate.

Seating and Safety Restraints

The purpose of the BeltMinder is to remind occasional wearers to wear safety belts all of the time.

The following are reasons most often given for not wearing safety belts:
(All statistics based on U.S. data)

Reasons given...	Consider...
“Crashes are rare events”	36700 crashes occur every day. The more we drive, the more we are exposed to “rare” events, even for good drivers. <i>1 in 4 of us will be seriously injured in a crash during our lifetime.</i>
“I’m not going far”	3 of 4 fatal crashes occur within 25 miles of home.
“Belts are uncomfortable”	We design our safety belts to enhance comfort. If you are uncomfortable - try different positions for the safety belt upper anchorage and seatback which should be as upright as possible; this can improve comfort.
“I was in a hurry”	Prime time for an accident. BeltMinder reminds us to take a few seconds to buckle up.
“Safety belts don’t work”	Safety belts , when used properly, reduce risk of death to front seat occupants by 45% in cars , and by 60% in light trucks .
“Traffic is light”	Nearly 1 of 2 deaths occur in single-vehicle crashes , many when no other vehicles are around.
“Belts wrinkle my clothes”	Possibly, but a serious crash can do much more than wrinkle your clothes, particularly if you are unbelted.
“The people I’m with don’t wear belts”	Set the example, teen deaths occur 4 times more often in vehicles with TWO or MORE people. Children and younger brothers/sisters imitate behavior they see.
“I have an air bag”	Air bags offer greater protection when used with safety belts. Frontal airbags are not designed to inflate in rear and side crashes or rollovers.

Seating and Safety Restraints

Reasons given...	Consider...
"I'd rather be thrown clear"	Not a good idea. People who are ejected are 40 times more likely to DIE . Safety belts help prevent ejection, WE CAN'T "PICK OUR CRASH".



Do not sit on top of a buckled safety belt to avoid the Belt Minder chime. Sitting on the safety belt will increase the risk of injury in an accident. To disable (one-time) or deactivate the Belt Minder feature please follow the directions stated below.

One time disable

Any time the safety belt is buckled and then unbuckled during an ignition ON cycle, BeltMinder will be disabled for that ignition cycle only.

Deactivating/activating the BeltMinder feature

Read steps 1 - 9 thoroughly before proceeding with the deactivation/activation programming procedure.

The BeltMinder feature can be deactivated/activated by performing the following procedure:

Before following the procedure, make sure that:

- The parking brake is set.
- The gearshift is in P (Park) (automatic transmission) or the neutral position (manual transmission).
- The ignition switch is in the OFF position.
- All vehicle doors are closed.
- The driver's safety belt is unbuckled.
- The parklamps are in OFF position.



To reduce the risk of injury, do not deactivate/activate the Belt Minder feature while driving the vehicle.

1. Turn the ignition switch to the RUN (or ON) position. (DO NOT START THE ENGINE.)
2. Wait until the safety belt warning light turns off. (Approximately 1–2 minutes.)
 - Steps 3–5 must be completed within 60 seconds or the procedure will have to be repeated.

Seating and Safety Restraints

3. Buckle then unbuckle the safety belt three times, ending with the safety belt unbuckled. This can be done before or during BeltMinder warning activation.
4. Turn on the parklamps, turn off the parklamps.
5. Buckle then unbuckle the safety belt three times, ending with the safety belt unbuckled.
 - After step 5 the safety belt warning light will be turned on for three seconds.
6. Within seven seconds of the safety belt warning light turning off, buckle then unbuckle the safety belt.
 - This will disable BeltMinder if it is currently enabled, or enable BeltMinder if it is currently disabled.
7. Confirmation of disabling BeltMinder is provided by the safety belt warning light flashing four times per second for three seconds.
8. Confirmation of enabling BeltMinder is provided by:
 - The safety belt warning light flashing four times per second for three seconds.
 - Followed by three seconds with the safety belt warning light off.
 - Once again, the safety belt warning light will flash four times per second for three seconds.
9. After receiving confirmation, the deactivation/activation procedure is complete.

Safety belt extension assembly

If the safety belt is too short when fully extended, there is a 20 cm (8 inch) safety belt extension assembly that can be added (part number 611C22). This assembly can be obtained from your dealer at no cost.

Use only extensions manufactured by the same supplier as the safety belt. Manufacturer identification is located at the end of the webbing on the label. Also, use the safety belt extension only if the safety belt is too short for you when fully extended.

Do not use extensions to change the fit of the shoulder belt across the torso.

Safety belt maintenance

Inspect the safety belt systems periodically to make sure they work properly and are not damaged. Inspect the safety belts to make sure

Seating and Safety Restraints

there are no nicks, tears or cuts. Replace if necessary. All safety belt assemblies, including retractors, buckles, front seat belt buckle assemblies, buckle support assemblies (slide bar-if equipped), shoulder belt height adjusters (if equipped), shoulder belt guide on seatback (if equipped), child safety seat tether bracket assemblies (if equipped), LATCH child seat tether anchors and lower anchors (if equipped), and attaching hardware, should be inspected after a collision. Ford recommends that all safety belt assemblies used in vehicles involved in a collision be replaced. However, if the collision was minor and a qualified technician finds that the belts do not show damage and continue to operate properly, they do not need to be replaced. Safety belt assemblies not in use during a collision should also be inspected and replaced if either damage or improper operation is noted.



Failure to inspect and if necessary replace the safety belt assembly under the above conditions could result in severe personal injuries in the event of a collision.

Refer to *Interior* in the *Cleaning* chapter.

AIR BAG SUPPLEMENTAL RESTRAINT SYSTEM (SRS)

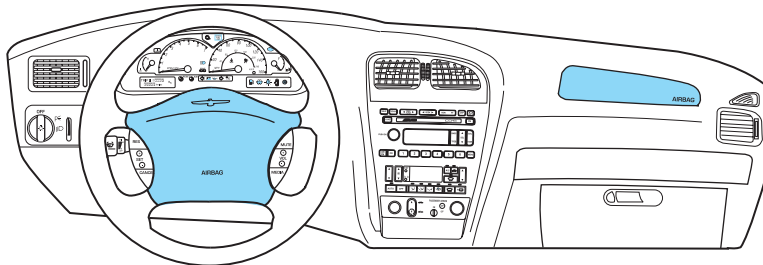

Your vehicle is equipped with a crash sensing and diagnostic module which records information about the air bag and sensor systems. In the event of a collision this module may save information related to the collision including information about the air bag system and impact severity. This information will assist Ford Motor Company in servicing the vehicle and in helping to better understand real world collisions and further improve the safety of future vehicles.

Seating and Safety Restraints

Important supplemental restraint system (SRS) precautions

The supplemental restraint system is designed to work with the safety belt to help protect the driver and right front passenger from certain upper body injuries.

Air bags DO NOT inflate slowly or gently and the risk of injury from a deploying air bag is greatest close to the trim covering the air bag module.

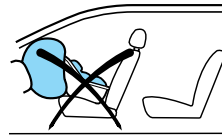

 All occupants of the vehicle, including the driver, should always properly wear their safety belts, even when an air bag (SRS) is provided.

 National Highway Traffic Safety Administration (NHTSA) recommends a minimum distance of at least 25 cm (10 inches) between an occupant's chest and the driver air bag module.

 Never place your arm over the air bag module as a deploying air bag can result in serious arm fractures or other injuries.

Steps you can take to properly position yourself away from the air bag:

- Move your seat to the rear as far as you can while still reaching the pedals comfortably.
- Recline the seat slightly (one or two degrees) from the upright position.

 Do not put anything on or over the air bag module. Placing objects on or over the air bag inflation area may cause those objects to be propelled by the air bag into your face and torso causing serious injury.

 Do not attempt to service, repair, or modify the Air Bag Supplemental Restraint System or its fuses. See your Ford or Lincoln Mercury dealer.

Seating and Safety Restraints

 Modifications to the front end of the vehicle, including frame, bumper, front end body structure and tow hooks may affect the performance of the air bag sensors increasing the risk of injury. Do not modify the front end of the vehicle.

Children and air bags

For additional important safety information, read all information on safety restraints in this guide.

Children must always be properly restrained. Failure to follow these instructions may increase the risk of injury in a collision.

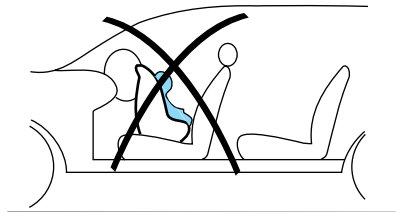

 Air bags can kill or injure a child in a child seat. **NEVER** place a rear-facing child seat in front of an active air bag. If you must use a forward-facing child seat in the front seat, move the seat all the way back and turn the passenger air bag off. Refer to *Passenger air bag ON/OFF switch* in this chapter of the owner's guide.

How does the safety belt pretensioner and air bag supplemental restraint system work?

The safety belt pretensioner and air bag SRS are designed to activate when the vehicle sustains longitudinal deceleration sufficient to cause the sensors to close an electrical circuit that initiates pretensioner activation and air bag inflation.

The fact that the pretensioners and air bags did not activate in a collision does not mean that something is wrong with the system. Rather, it means the forces were not of the type sufficient to cause activation. Front air bags and pretensioners are designed to activate in frontal and near-frontal

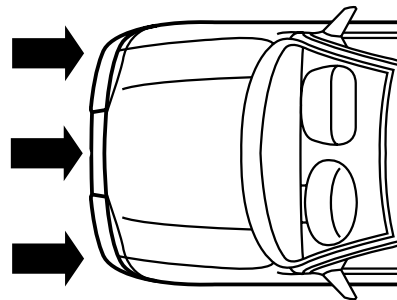

Seating and Safety Restraints

collisions, not rollover, side-impact, or rear-impacts unless the collision causes sufficient longitudinal deceleration.

The air bags inflate and deflate rapidly upon activation. After air bag deployment, it is normal to notice a smoke-like, powdery residue or smell the burnt propellant. This may consist of cornstarch, talcum powder (to lubricate the bag) or sodium compounds (e.g., baking soda) that result from the combustion process that inflates the air bag. Small amounts of sodium hydroxide may be present which may irritate the skin and eyes, but none of the residue is toxic.



While the system is designed to help reduce serious injuries, contact with a deploying air bag may also cause abrasions, swelling or temporary hearing loss. Because air bags must inflate rapidly and with considerable force, there is the risk of death or serious injuries such as fractures, facial and eye injuries or internal injuries, particularly to occupants who are not properly restrained or are otherwise out of position at the time of air bag deployment. Thus, it is extremely important that occupants be properly restrained as far away from the air bag module as possible while maintaining vehicle control.



Several air bag system components get hot after inflation. Do not touch them after inflation.



If the air bag has deployed, **the air bag will not function again and must be replaced immediately.** If the air bag is not replaced, the unrepaired area will increase the risk of injury in a collision.

Seating and Safety Restraints

The SRS consists of:

- driver and passenger air bag modules (which include the inflators and air bags)
- side air bags (if equipped). Refer to *Side air bag system* later in this chapter
- safety belt pretensioners
- one or more impact and safing sensors
- a readiness light and tone
- and the electrical wiring which connects the components

The diagnostic module monitors its own internal circuits and the supplemental air bag electrical system warning (including the impact sensors), the system wiring, the air bag system readiness light, the air bag back up power, the air bag ignitors and safety belt pretensioners.

Determining if the system is operational

The SRS uses a readiness light in the instrument cluster or a tone to indicate the condition of the system. Refer to the *Air bag readiness* section in the *Instrument cluster* chapter. Routine maintenance of the air bag is not required.

Any difficulty with the system is indicated by one or more of the following:

- The readiness light will either flash or stay lit
- The readiness light will not illuminate immediately after ignition is turned to the RUN position
- A series of five beeps will be heard. The tone pattern will repeat periodically until the problem and/or light are repaired.



If any of these things happen, even intermittently, have the SRS serviced at your dealership or by a qualified technician immediately. Unless serviced, the system may not function properly in the event of a collision.

Seating and Safety Restraints

Passenger front and side air bag ON/OFF switch

 An air bag ON/OFF switch has been installed in this vehicle. Before driving, *always* look at the face of the switch to be sure the switch is in the proper position in accordance with these instructions and warnings. Failure to put the switch in a proper position can increase the risk of serious injury or death in a collision.

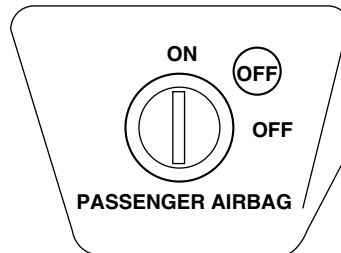

Turning the passenger front and side air bags off

1. Insert the ignition key, turn the switch to OFF position and hold in OFF position while removing the key.
2. When the ignition is turned to the ON position the OFF light illuminates briefly, momentarily shuts off and then turns back on. This indicates that the passenger front and side air bags are deactivated.

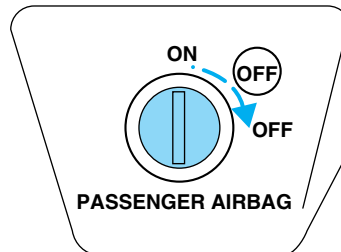

 If the light fails to illuminate when the front and side passenger air bag switch is in the OFF position and the ignition switch is in ON, have the front and side passenger air bag switch serviced at your Ford or Lincoln-Mercury dealer.

 In order to avoid inadvertent activation of the switch, always remove the ignition key from the front and side passenger air bag ON/OFF switch.

Turning the front and side passenger air bags back on

The front and side passenger air bags remain OFF until you turn them back ON.

Seating and Safety Restraints

1. Insert the ignition key and turn the switch to ON.
2. The OFF light will briefly illuminate when the ignition is turned to ON. This indicates that the passenger front and side air bags are operational.

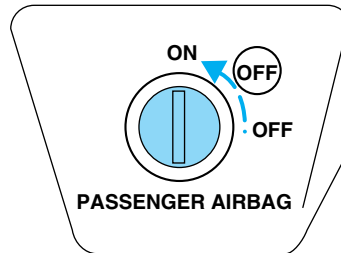

 If the light is illuminated when the front and side passenger air bag ON/OFF switch is in the ON position and the ignition switch is in ON, have the front and side passenger air bag ON/OFF switch serviced at your Ford or Lincoln-Mercury dealer immediately.

The front passenger air bag and the passenger side air bag should always be ON (the air bag OFF light should *not* be illuminated) unless the passenger is a person who meets the requirements stated either in Category 1, 2 or 3 of the NHTSA/Transport Canada deactivation criteria which follows.

 The safety belts for the driver and right front passenger seating positions have been specifically designed to function together with the air bags in certain types of crashes. When you turn OFF your air bag, you not only lose the protection of the air bag, you also may reduce the effectiveness of your safety belt system, which was designed to work with the air bag. If you are not a person who meets the requirements stated in the NHTSA/Transport Canada deactivation criteria turning OFF the air bag can increase the risk of serious injury or death in a collision.

 Always use safety belts and child restraints properly. If a child in a rear facing infant seat must be transported in front, the passenger air bag *must* be turned OFF. This is because the back of the infant seat is too close to the inflating air bag and the risk of a fatal injury to the infant when the air bag inflates is substantial.

The vast majority of drivers and passengers are much safer with an air bag than without. To do their job and reduce the risk of life threatening injuries, air bags must open with great force, and this force can pose a potentially deadly risk in some situations, particularly when a front seat

Seating and Safety Restraints

occupant is not properly buckled up. The most effective way to reduce the risk of unnecessary air bag injuries, without reducing the overall safety of the vehicle, is to make sure all occupants are properly restrained in the vehicle, especially in the front seat. This provides the protection of safety belts and permits the air bags to provide the additional protection they were designed to provide. If you choose to deactivate your air bag, you are losing the very significant risk reducing benefits of the air bag and you are also reducing the effectiveness of the safety belts, because safety belts in modern vehicles are designed to work as a safety system with the air bags.

Read all air bag Warning labels in the vehicle as well as the other important air bag instructions and Warnings in this Owner's Guide.

NHTSA deactivation criteria (excluding Canada)

1. **Infant.** An infant (less than 1 year old) must ride in the front seat because:
 - the vehicle has no rear seat, or
 - the vehicle has a rear seat too small to accommodate a rear-facing infant seat, or
 - the infant has a medical condition which, according to the infant's physician, makes it necessary for the infant to ride in the front so that the driver can constantly monitor the child's condition.
2. **Child age 1 to 12.** A child age 1 to 12 must ride in the front seat because:
 - the vehicle has no rear seat, or
 - although children ages 1 to 12 ride in the rear seat(s) whenever possible, children ages 1 to 12 sometimes must ride in the front because no space is available in the rear seat(s) of the vehicle, or
 - the child has a medical condition which, according to the child's physician, makes it necessary for the child to ride in the front seat so that the driver can constantly monitor the child's condition.
3. **Medical condition.** A passenger has a medical condition which, according to his or her physician:
 - causes the passenger air bag to pose a special risk for the passenger and
 - makes the potential harm from the passenger air bag in a crash greater than the potential harm from turning OFF the air bag and allowing the passenger, even if belted, to hit the dashboard or windshield in a crash.

Seating and Safety Restraints



This vehicle has special energy management safety belts for the driver and right front passenger. These particular belts are specifically designed to work with air bags to help reduce the risk of injury in a collision. The energy management safety belt is designed to give or release additional belt webbing in some accidents to reduce concentration of force on an occupant's chest and reduce the risk of certain bone fractures and injuries to underlying organs. In a crash, if the air bag is turned OFF, this energy management safety belt might permit the person wearing the belt to move forward enough to incur a serious or fatal injury. The more severe the crash, and the heavier the occupant, the greater the risk is. Be sure the air bag is turned ON for any person who does not qualify under the NHTSA deactivation criteria.

Transport Canada deactivation criteria (Canada Only)

1. **Infant:** An infant (less than 1 year old) must ride in the front seat because:
 - my vehicle has no rear seat, or
 - the rear seat in my vehicle cannot accommodate a rear-facing infant seat, or
 - the infant has a medical condition which, according to the infant's physician, makes it necessary for the infant to ride in the front seat so that the driver can monitor the infant's condition.
2. **Child age 12 or under:** A child age 12 or under must ride in the front seat because:
 - my vehicle has no rear seat, or
 - although children age 12 and under ride in the rear seat whenever possible, children age 12 and under have no option but to sometimes ride in the front seat because rear seat space is insufficient, or
 - the child has a medical condition that, according to the child's physician, makes it necessary for the child to ride in the front seat so that the driver can monitor the child's condition.
3. **Medical condition:** A passenger has a medical condition that, according to his or her physician:
 - poses a special risk for the passenger if the air bag deploys and
 - makes the potential harm from the passenger air bag deployment greater than the potential harm from turning OFF the air bag and experiencing a crash without the protection offered by the air bag

Seating and Safety Restraints

 This vehicle has special energy management safety belts for the driver and right front passenger. These particular belts are specifically designed to work with air bags to help reduce the risk of injury in a collision. The energy management safety belt is designed to give or release additional belt webbing in some accidents to reduce concentration of force on an occupant's chest and reduce the risk of certain bone fractures and injuries to underlying organs. In a crash, if the air bag is turned OFF, this energy management safety belt might permit the person wearing the belt to move forward enough to incur a serious or fatal injury. The more severe the crash, and the heavier the occupant, the greater the risk is. Be sure the air bag is turned ON for any person who does not qualify under the Transport Canada deactivation criteria.

Side air bag system

 Do not place objects or mount equipment on or near the air bag cover on the side of the seatbacks of the front seats or in front seat areas that may come into contact with a deploying air bag. Failure to follow these instructions may increase the risk of personal injury in the event of a collision.

 Do not use accessory seat covers. The use of accessory seat covers may prevent the deployment of the side air bags and increase the risk of injury in an accident.

 Do not lean your head on the door. The side air bag could injure you as it deploys from the side of the seatback.

 Do not attempt to service, repair, or modify the air bag supplemental restraint system, its fuses or the seat cover on a seat containing an air bag. See your Ford or Lincoln Mercury dealer.

 All occupants of the vehicle including the driver should always wear their safety belts even when an air bag SRS is provided.

Seating and Safety Restraints



Do not place objects or mount equipment on or near the air bag cover on the side of the seatbacks of the front seats or in front seat areas that may come into contact with a deploying air bag. Failure to follow these instructions may increase the risk of personal injury in the event of a collision.



Do not use accessory seat covers. The use of accessory seat covers may prevent the deployment of the side air bags and increase the risk of injury in an accident.



Do not lean your head on the door. The side air bag could injure you as it deploys from the side of the seatback.



Do not attempt to service, repair, or modify the air bag SRS, its fuses or the seat cover on a seat containing an air bag. See your Ford or Lincoln Mercury dealer.



All occupants of the vehicle should always wear their safety belts even when an air bag SRS is provided.

Seating and Safety Restraints

How does the side air bag system work?

The side air bag system consists of the following:

- An inflatable nylon bag (air bag) with a gas generator concealed behind the outboard bolster of the driver and front passenger seatbacks.
- A special seat cover designed to allow air bag deployment.
- The same warning light, electronic control and diagnostic unit as used for the front air bags.
- Two crash sensors located under the outboard side of the front seats, attached near the floor.

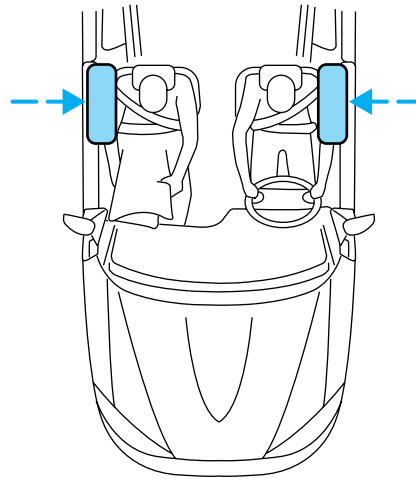

Side air bags, in combination with seat belts, can help reduce the risk of severe injuries in the event of a significant side impact collision.

The side air bags are fitted on the outboard side of the seatbacks of the front seats. In certain lateral collisions, the air bag on the side affected by the collision will be inflated, even if the respective seat is not occupied. The air bag was designed to inflate between the door panel and occupant to further enhance the protection provided occupants in side impact collisions.

The air bag SRS is designed to activate when the vehicle sustains lateral deceleration sufficient to cause the sensors to close an electrical circuit that initiates air bag inflation.

The fact that the air bags did not inflate in a collision does not mean that something is wrong with the system. Rather, it means the forces were not of the type sufficient to cause activation. Side air bags are designed to inflate in side-impact collisions, not roll-over, rear-impact, frontal or near-frontal collisions, unless the collision causes sufficient lateral deceleration.

Seating and Safety Restraints

 Several air bag system components get hot after inflation. Do not touch them after inflation.

 If the side air bag has deployed, **the air bag will not function again. The side air bag system (including the seat) must be inspected and serviced by a qualified technician in accordance with the vehicle service manual.** If the air bag is not replaced, the unrepaired area will increase the risk of injury in a collision.

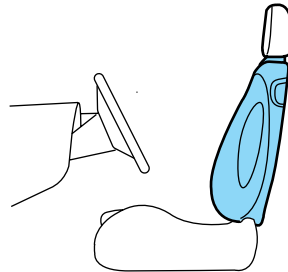

Determining if the system is operational

The SRS uses a readiness light in the instrument cluster or a tone to indicate the condition of the system. Refer to the *Air bag readiness* section in the *Instrument cluster* chapter. Routine maintenance of the air bag is not required.

Any difficulty with the system is indicated by one or more of the following:

- The readiness light (same light as used for front air bag system) will either flash or stay lit.
- The readiness light will not illuminate immediately after ignition is turned to the RUN position.
- A series of five beeps will be heard. The tone pattern will repeat periodically until the problem and light are repaired.

If any of these things happen, even intermittently, have the SRS serviced at your dealership or by a qualified technician immediately. Unless serviced, the system may not function properly in the event of a collision.

Seating and Safety Restraints

Disposal of air bags and air bag equipped vehicles (including pretensioners)

For disposal of air bags or air bag equipped vehicles, see your local dealership or qualified technician. Air bags **MUST BE** disposed of by qualified personnel.

SAFETY RESTRAINTS FOR CHILDREN

See the following sections for directions on how to properly use safety restraints for children. Also see *Air bag supplemental restraint system (SRS)* in this chapter for special instructions about using air bags.

Important child restraint precautions

You are required by law to use safety restraints for children in the U.S. and Canada. If small children ride in your vehicle (generally children who are four years old or younger and who weigh 18 kg [40 lbs] or less), you must put them in safety seats made especially for children. Check your local and state or provincial laws for specific requirements regarding the safety of children in your vehicle.



Never let a passenger hold a child on his or her lap while the vehicle is moving. The passenger cannot protect the child from injury in a collision.

Always follow the instructions and warnings that come with any infant or child restraint you might use.

Children and safety belts

If the child is the proper size, restrain the child in a safety seat. Children who are too large for child safety seats (as specified by your child safety seat manufacturer) should always wear safety belts.

Follow all the important safety restraint and air bag precautions that apply to adult passengers in your vehicle.

If the shoulder belt portion of a combination lap and shoulder belt can be positioned so it does not cross or rest in front of the child's face or neck, the child should wear the lap and shoulder belt. Moving the child closer to the center of the vehicle may help provide a good shoulder belt fit.



Do not leave children, unreliable adults, or pets unattended in your vehicle.

Seating and Safety Restraints

Child booster seats

Children outgrow a typical convertible or toddler seat when they weigh 40 pounds and are around 4 years of age. Although the lap/shoulder belt will provide some protection, these children are still too small for lap/shoulder belts to fit properly, which could increase the risk of serious injury.

To improve the fit of both the lap and shoulder belt on children who have outgrown child safety seats, Ford Motor Company recommends use of a belt-positioning booster.

Booster seats position a child so that safety belts fit better. They lift the child up so that the lap belt rests low across the hips and the knees bend comfortably. Booster seats also make the shoulder belt fit better and more comfortably for growing children.

When children should use booster seats

Children need to use booster seats from the time they outgrow the toddler seat until they are big enough for the vehicle seat and lap/shoulder belt to fit properly. Generally this is when they weigh about 80 lbs (about 8 to 12 years old).

Booster seats should be used until you can answer YES to ALL of these questions:

- Can the child sit all the way back against the vehicle seat back with knees bent comfortably at the edge of the seat without slouching?
- Does the lap belt rest low across the hips?
- Is the shoulder belt centered on the shoulder and chest?
- Can the child stay seated like this for the whole trip?

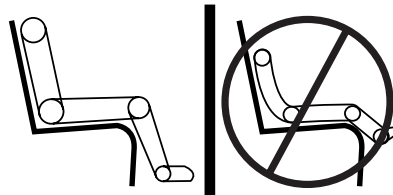

Seating and Safety Restraints

Types of booster seats

There are two types of belt-positioning booster seats:

- Those that are backless.

If your backless booster seat has a removable shield, remove the shield and use the lap/shoulder belt. If a seating position has a low seat back and no head restraint, a backless booster seat may place your child's head (top of ear level) above the top of the seat. In this case, move the backless booster to another seating position with a higher seat back and lap/shoulder belts.



- Those with a high back.

If, with a backless booster seat, you cannot find a seating position that adequately supports your child's head, a high back booster seat would be a better choice.



Both can be used in any vehicle in a seating position equipped with lap/shoulder belts if your child is over 40 lbs.

The shoulder belt should cross the chest, resting snugly on the center of the shoulder. The lap belt should rest low and snug across the hips, never up high across the stomach.

If the booster seat slides on the vehicle seat, placing a rubberized mesh sold as shelf or carpet liner under the booster seat may improve this condition.

The importance of shoulder belts

Using a booster without a shoulder belt increases the risk of a child's head hitting a hard surface in a collision. For this reason, you should never use a booster seat with a lap belt only. It is best to use a booster seat with lap/shoulder belts in the back seat- the safest place for children to ride.

Seating and Safety Restraints



Follow all instructions provided by the manufacturer of the booster seat.



Never put the shoulder belt under a child's arm or behind the back because it eliminates the protection for the upper part of the body and may increase the risk of injury or death in a collision.



Never use pillows, books, or towels to boost a child. They can slide around and increase the likelihood of injury or death in a collision.

SAFETY SEATS FOR CHILDREN



Child and infant or child safety seats

Use a safety seat that is recommended for the size and weight of the child. Carefully follow all of the manufacturer's instructions with the safety seat you put in your vehicle. If you do not install and use the safety seat properly, the child may be injured in a sudden stop or collision.

Seating and Safety Restraints

When installing a child safety seat:

- Review and follow the information presented in the *Air Bag Supplemental Restraint System* section in this chapter.
- Use the correct safety belt buckle for that seating position.
- Insert the belt tongue into the proper buckle until you hear a snap and feel it latch. Make sure the tongue is securely fastened in the buckle.
- Keep the buckle release button pointing up and away from the safety seat, with the tongue between the child seat and the release button, to prevent accidental unbuckling.
- Place seat back in upright position.
- Put the safety belt in the automatic locking mode. Refer to *Automatic locking mode*.

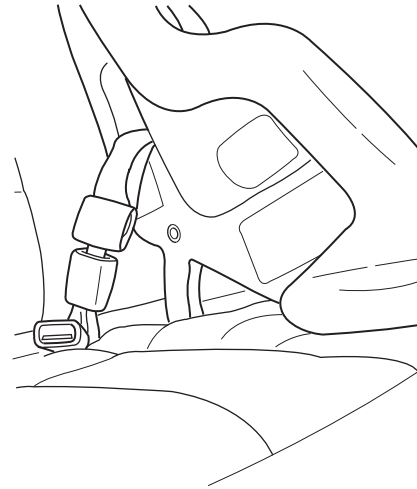

Ford recommends the use of a child safety seat having a top tether strap. Install the child safety seat in a seating position which is capable of providing a tether anchorage. For more information on top tether straps, refer to *Attaching safety seats with tether straps* in this chapter.



Carefully follow all of the manufacturer's instructions included with the safety seat you put in your vehicle. If you do not install and use the safety seat properly, the child may be injured in a sudden stop or collision.

Installing child safety seats in combination lap and shoulder belt seating positions



Air bags can kill or injure a child in a child seat. **NEVER** place a rear-facing child seat in front of an active air bag. If you must use a forward-facing child seat in the front seat, move the seat all the way back and turn the passenger air bags OFF.

Seating and Safety Restraints

1. Position the child safety seat in a seat with a combination lap and shoulder belt.

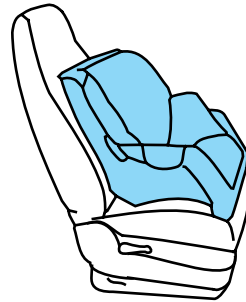

2. Pull down on the shoulder belt and then grasp the shoulder belt and lap belt together.

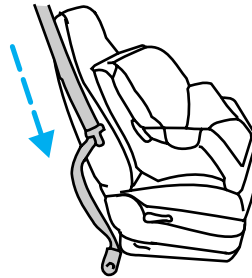

3. While holding the shoulder and lap belt portions together, route the tongue through the child seat according to the child seat manufacturer's instructions. Be sure the belt webbing is not twisted.

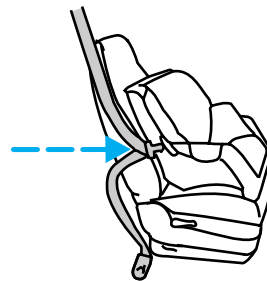

Seating and Safety Restraints

4. Insert the belt tongue into the proper buckle (the buckle closest to the direction the tongue is coming from) for that seating position until you hear a snap and feel the latch engage. Make sure the tongue is latched securely by pulling on it.

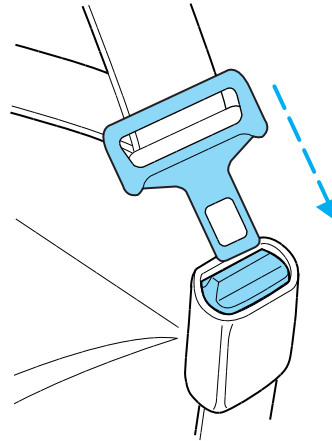

5. To put the retractor in the automatic locking mode, grasp the shoulder portion of the belt and pull downward until all of the belt is extracted and a click is heard.

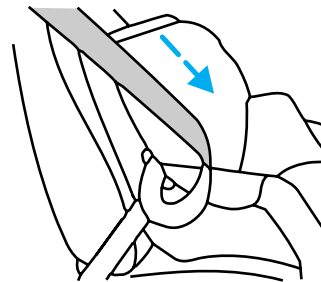

6. Allow the belt to retract. The belt will click as it retracts to indicate it is in the automatic locking mode.

7. Pull the lap belt portion across the child seat toward the buckle and pull up on the shoulder belt while pushing down with your knee on the child seat.

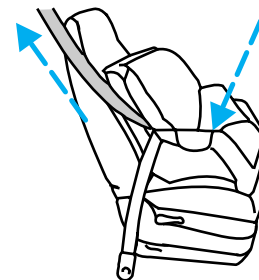

Seating and Safety Restraints

8. Allow the safety belt to retract to remove any slack in the belt.

9. Before placing the child in the seat, forcibly move the seat forward and back to make sure the seat is securely held in place. To check this, grab the seat at the belt path and attempt to move it side to side and forward. There should be no more than one inch of movement for proper installation.

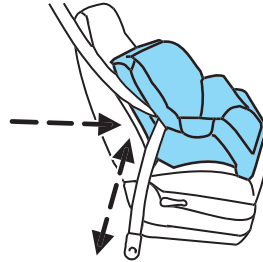

10. Try to pull the belt out of the retractor to make sure the retractor is in the automatic locking mode (you should not be able to pull more belt out). If the retractor is not locked, unbuckle the belt and repeat steps two through nine.

Check to make sure the child seat is properly secured before each use.

Attaching child safety seats with tether straps

Most new forward-facing child safety seats include a tether strap which goes over the back of the seat and hooks to an anchoring point. Tether straps are available as an accessory for many older safety seats. Contact the manufacturer of your child seat for information about ordering a tether strap.

The tether strap anchors in your vehicle are in the following positions (shown from top view):

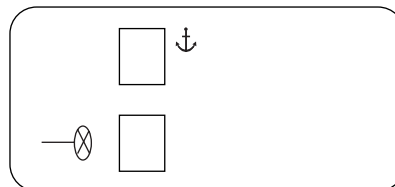

Attach the tether strap only to the appropriate tether anchor as shown. The tether strap may not work properly if attached somewhere other than the correct tether anchor.

1. Position the child safety seat on the passenger seat cushion.

Seating and Safety Restraints

2. Locate the tether anchor at the bottom back of the passenger seat.

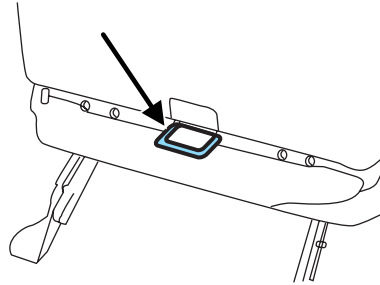

3. Route the child safety seat tether strap under the head restraint and over the back of the seat.

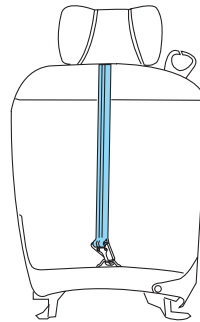

4. Grasp the tether strap and position it to the seat frame.

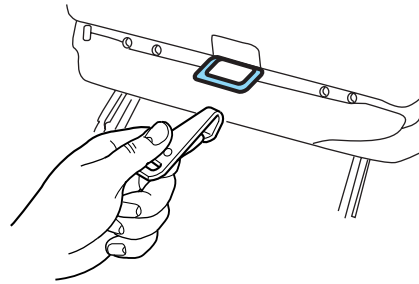

Seating and Safety Restraints

5. Rotate the tether strap.

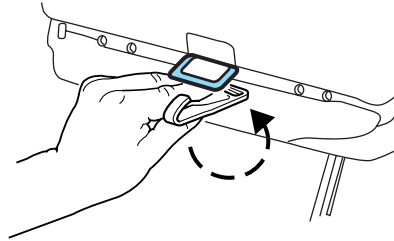

6. Clip the tether strap to the anchor on the seat frame.

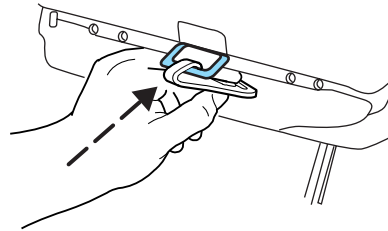

7. Rotate the tether strap clip.

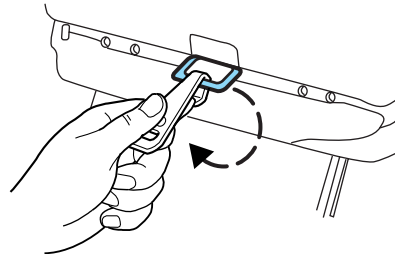

Seating and Safety Restraints

8. Tighten the child safety seat tether strap according to the manufacturer's instructions.

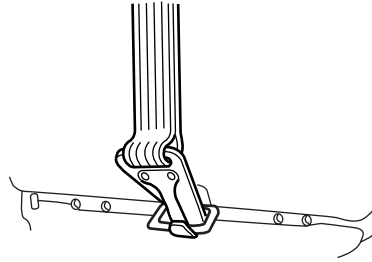

Attaching child safety seats with Lower Anchor and Tethers for Children (LATCH) attachments for child seat anchors

Some child safety seats are labeled as LATCH or LATCH-compatible child seats. These seats include two rigid or webbing mounted attachments that connect to two anchors at specific seating positions in your vehicle. This type of child seat eliminates the need to use safety belts to attach the child seat. For forward-facing child seats, the tether strap must also be attached to the proper tether anchor point. For information on using tether straps with the child safety seats, refer to *Passenger front and side air bag ON/OFF switch* and *Attaching child safety seats with tether straps* in this chapter.

A LATCH system for child seat installation has been provided in your vehicle at the following location:

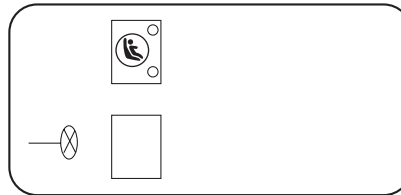

Seating and Safety Restraints

The lower anchors for child seat installation are located at the rear section (as viewed from the front of the seat) of the passenger seat between the cushion and seat back.

Follow the child seat manufacturer's instructions to properly install safety seats with LATCH lower anchors and LATCH-compatible attachments.

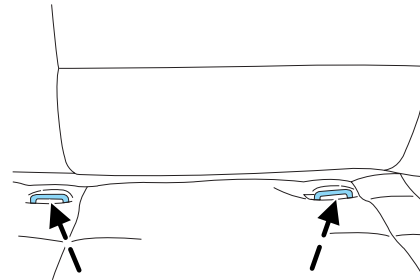

 Attach the lower anchors for child seat installation or lower anchor for child seat installation-compatible child seat only to the appropriate location shown.

If you install a child seat with rigid LATCH attachments, do not tighten the tether strap enough to lift the child seat off the seat when the child is seated in it. Keep the tether strap just snug without raising the front of the child seat. Keeping the child seat just touching the front of the vehicle seat gives the best protection in a severe crash. Once you have installed the lower anchors for child seat installation safety seat, assure that the seat is properly attached to the lower anchors for child seat installation and tether anchors. Also, test the safety seat before you place the child in it. Tilt the seat from side to side. Also try to tug the seat forward. Check to see if the anchors hold the seat in place.

 If the safety seat is not anchored properly, the risk of a child being injured in a collision greatly increases.

STARTING

Positions of the ignition

1. LOCK, locks the gearshift lever and allows key removal. (The steering wheel will not lock after key removal.)
2. OFF, shuts off the engine and all accessories except the radio, convertible top control and the power windows if accessory delay is active. This position also allows the automatic transmission shift lever to be moved from the P (Park) position without the brake pedal being depressed.

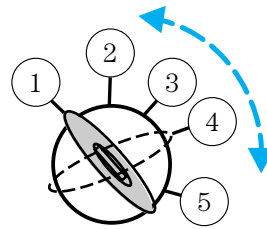

 When the key is in the ignition OFF position, the automatic transmission shift lever can be moved from the P (Park) position without the brake pedal depressed. To avoid unwanted vehicle movement, always set the parking brake.

3. ACCESSORY, allows the electrical accessories such as the radio to operate while the engine is not running.
4. RUN, all electrical circuits operational. Warning lights illuminated. Key position when driving.
5. START, cranks the engine. Release the key as soon as the engine starts.

Preparing to start your vehicle

Engine starting is controlled by the powertrain control system. This system meets all Canadian Interference-Causing Equipment standard requirements regulating the impulse electrical field strength of radio noise.

When starting a fuel-injected engine, avoid pressing the accelerator before or during starting. Only use the accelerator when you have difficulty starting the engine. For more information on starting the vehicle, refer to *Starting the engine* in this chapter.

Driving

 Extended idling at high engine speeds can produce very high temperatures in the engine and exhaust system, creating the risk of fire or other damage.

 Do not park, idle, or drive your vehicle in dry grass or other dry ground cover. The emission system heats up the engine compartment and exhaust system, which can start a fire.

 Do not start your vehicle in a closed garage or in other enclosed areas. Exhaust fumes can be toxic. Always open the garage door before you start the engine. See *Guarding against exhaust fumes* in this chapter for more instructions.

 If you smell exhaust fumes inside your vehicle, have your dealer inspect your vehicle immediately. Do not drive if you smell exhaust fumes.

Important safety precautions

A computer system controls the engine's idle revolutions per minute (RPM). When the engine starts, the idle RPM runs higher than normal in order to warm the engine. If the engine idle speed does not slow down automatically, have the vehicle checked. Do not allow the vehicle to idle for more than 10 minutes at high engine RPM.

Before starting the vehicle:

1. Make sure all vehicle occupants have buckled their safety belts. For more information on safety belts and their proper usage, refer to the *Seating and safety restraints* chapter.
2. Make sure the headlamps and vehicle accessories are off.
3. Make sure the parking brake is set.
4. Make sure the gearshift is in P (Park).

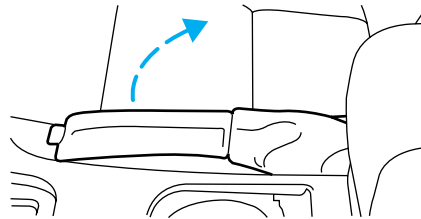

Driving

5. Turn the key to 4 (RUN) without turning the key to 5 (START).

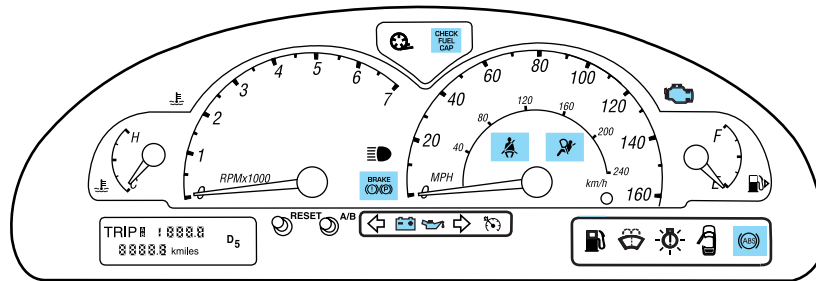
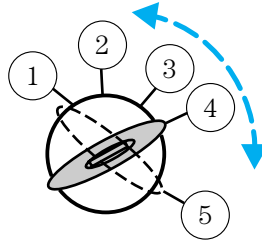

Make sure the corresponding lights illuminate or illuminate briefly. If a light fails to illuminate, have the vehicle serviced.

- If the driver's safety belt is fastened, the  light may not illuminate.

Starting the engine

Note: Whenever you start your vehicle, release the key as soon as the engine starts. Excessive cranking could damage the starter.

1. Turn the key to 5 (START) without pressing the accelerator pedal and release as soon as the engine starts. The key will return to 4 (RUN).

2. If the temperature is above -12°C (10°F) and the engine does not start within five seconds on the first try, turn the key to OFF, wait 10 seconds and try again.

3. If the temperature is below -12°C (10°F) and the engine does not start in 15 seconds on the first try, turn the key OFF and wait 10 seconds and try again. If the engine does not start in two attempts, press the accelerator pedal all the way to floor and hold. Turn the key to START position.

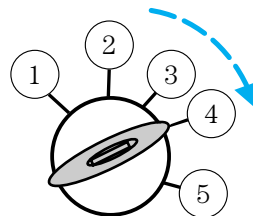

Driving

4. When the engine starts, release the key, then release the accelerator pedal gradually as the engine speeds up.
5. After idling for a few seconds, apply the brake, shift into gear and drive.

Using the engine block heater (if equipped)

An engine block heater warms the engine coolant, which improves starting, warms up the engine faster and allows the heater-defroster system to respond quickly. Use of an engine block heater is strongly recommended if you live in a region where temperatures reach -23°C (-10°F) or below.

For best results, plug the heater in at least three hours before starting the vehicle. Using the heater for longer than three hours will not harm the engine, so the heater can be plugged in the night before starting the vehicle.



To prevent electrical shock, do not use your heater with ungrounded electrical systems or two-pronged (cheater) adapters.

Guarding against exhaust fumes

Although odorless and colorless, carbon monoxide is present in exhaust fumes. Take precautions to avoid its dangerous effects.



If you ever smell exhaust fumes of any kind inside your vehicle, have your dealer inspect and fix your vehicle immediately. Do not drive if you smell exhaust fumes. These fumes are harmful and could kill you.

Have the exhaust and body ventilation systems checked whenever:

- the vehicle is raised for service.
- the sound of the exhaust system changes.
- the vehicle has been damaged in a collision.



WARNING: Engine exhaust, some of its constituents, and certain vehicle components contain or emit chemicals known to the State of California to cause cancer and birth defects or other reproductive harm. In addition, certain fluids contained in vehicles and certain products of component wear contain or emit chemicals known to the State of California to cause cancer and birth defects or other reproductive harm.

Important ventilating information

If the engine is idling while the vehicle is stopped in an open area for long periods of time, open the windows at least 2.5 cm (one inch).

Adjust the heating or air conditioning (if equipped) to bring in fresh air.

Improve vehicle ventilation by keeping all air inlet vents clear of snow, leaves and other debris.

BRAKES

Your service brakes are self-adjusting. Refer to the scheduled maintenance guide for scheduled maintenance.

Occasional brake noise is normal and often does not indicate a performance concern with the vehicle's brake system. In normal operation, automotive brake systems may emit occasional or intermittent squeal or groan noises when the brakes are applied. Such noises are usually heard during the first few brake applications in the morning; however, they may be heard at any time while braking and can be aggravated by environmental conditions such as cold, heat, moisture, road dust, salt or mud. If a "metal-to-metal," "continuous grinding" or "continuous squeal" sound is present while braking, the brake linings may be worn-out and should be inspected by a qualified service technician.



If you are driving down a long or steep hill, shift to a lower gear. Do not apply your brakes continuously, as they may overheat and become less effective.

Anti-lock brake system (ABS)

On vehicles equipped with an anti-lock braking system (ABS), a noise from the hydraulic pump motor and pulsation in the pedal may be observed during ABS braking events. Pedal pulsation coupled with noise while braking under panic conditions or on loose gravel, bumps, wet or snowy roads is normal and indicates proper functioning of the vehicle's anti-lock brake system. The ABS performs a self-check after you start the engine and begin to drive away. A brief mechanical noise may be heard during this test. This is normal. If a malfunction is found, the ABS warning light will come on. If the vehicle has continuous vibration or shudder in the steering wheel while braking, the vehicle should be inspected by a qualified service technician.

Driving

The ABS operates by detecting the onset of wheel lockup during brake applications and compensates for this tendency. The wheels are prevented from locking even when the brakes are firmly applied. The accompanying illustration depicts the advantage of an ABS equipped vehicle (on bottom) to a non-ABS equipped vehicle (on top) during hard braking with loss of front braking traction.

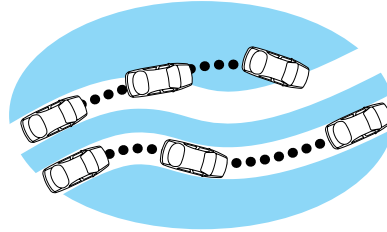

ABS warning lamp

The  warning lamp in the instrument cluster momentarily illuminates when the ignition is turned to the RUN position. If the light does not illuminate momentarily at start up, remains on or continues to flash, the ABS needs to be serviced.

With the ABS light on, the anti-lock brake system is disabled and normal braking is still effective unless the brake warning light also remains illuminated with parking brake

released. (If your brake warning lamp illuminates, have your vehicle serviced immediately.)

BRAKE

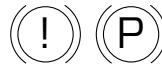

Using ABS

- In an emergency or when maximum efficiency from the four-wheel ABS is required, apply continuous force on the brake. The four wheel ABS will be activated immediately, thus allowing you to retain full steering control of your vehicle and, providing there is sufficient space, will enable you to avoid obstacles and bring the vehicle to a controlled stop.
- The anti-lock system does not reduce stopping distance. Always leave enough room between your vehicle and the vehicle in front of you to stop.
- We recommend that you familiarize yourself with this braking technique. However, avoid taking any unnecessary risks.

Parking brake (P)

Apply the parking brake whenever the vehicle is parked. To set the parking brake, apply the brake pedal and pull the handle up as far as possible.

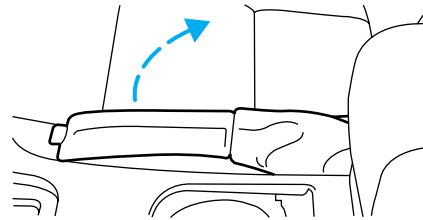

The BRAKE warning lamp in the instrument cluster illuminates and remains illuminated (when the ignition is turned to the RUN position) until the parking brake is released.



The parking brake is not recommended to stop a moving vehicle. However, if the normal brakes fail, the parking brake can be used to stop your vehicle in an emergency. Since the parking brake applies only the rear brakes, the vehicle's stopping distance will increase greatly and the handling of your vehicle will be adversely affected.



Always set the parking brake fully and make sure that the gearshift is securely latched in P (Park).

Your brake handle may need to be pulled up slightly to release pressure before pushing in the button.

Push the button on the end of the parking brake and push the handle down as far as possible to release the brake. Driving with the parking brake on will cause the brakes to wear out quickly and reduce fuel economy.

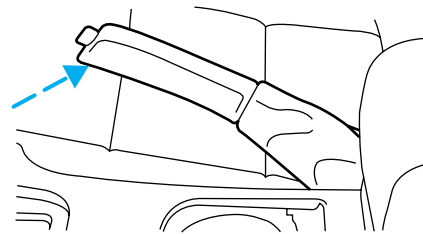

TRACTION CONTROL™ (IF EQUIPPED)

The Traction Control™ system helps maintain the stability and steerability of your vehicle. It is especially useful on slippery and/or hilly road surfaces. The system operates at all speeds by detecting and

Driving

controlling wheel spin. The system borrows many of the electronic and mechanical elements already present in the anti-lock braking system (ABS).

Wheel-speed sensors allow excess rear wheel spin to be detected by the Traction Control[™] portion of the ABS computer. Any excessive wheel spin is controlled by automatically applying and releasing the rear brakes in conjunction with engine torque reductions. Engine torque reduction is realized via the fully electronic spark and fuel injection systems. This process is very sensitive to driving conditions and very fast acting. The rear wheels “search” for optimum traction several times a second and adjustments are made accordingly.

The Traction Control[™] system will allow your vehicle to make better use of available traction on slippery surfaces. The system is a driver aid which makes your vehicle easier to handle primarily on snow and ice covered roads. This is especially evident if wheel spin-up should occur while turning.

During Traction Control[™] operation you may hear an electric motor type of sound coming from the engine compartment and the engine will not “rev-up” when you push further on the accelerator. This is normal system behavior.

If you should become stuck in snow or on a very slippery road surface, try switching the Traction Control[™] system off using the traction control switch located on the left-hand side of the instrument panel. This may allow excess wheel spin to “dig” the vehicle out or enable a successful “rocking” maneuver.

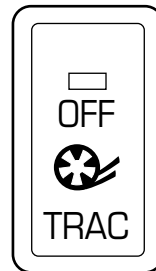

If the Traction Control[™] system is cycled excessively, the brake portion of the system will shut down to prevent the rear brakes from overheating. A limited Traction Control[™] function using only engine torque reduction will still help control wheels from over-spinning. When the rear brakes have cooled down, the system will again function normally. Anti-lock braking is not affected by this condition and will function normally during the cool down period.

Driving



Aggressive driving in any road conditions can cause you to lose control of your vehicle increasing the risk of severe personal injury or property damage. The occurrence of a Traction Control[™] event is an indication that at least some of the tires have exceeded their ability to grip the road; this may lead to an increased risk of loss of vehicle control, vehicle rollover, personal injury and death. If you experience a severe road event, SLOW DOWN.

STEERING

Your vehicle is equipped with power steering. Power steering uses energy from the engine to decrease the driver's effort in steering the vehicle.

To prevent damage to the power steering pump:

- Never hold the steering wheel to the extreme right or the extreme left for more than a few seconds when the engine is running.
- Do not operate the vehicle with the power steering pump fluid level below the MIN mark on the reservoir.

If the power steering system breaks down (or if the engine is turned off), you can steer the vehicle manually, but it takes more effort.

If the steering wanders or pulls, check for:

- Underinflated tire(s) on any wheel(s)
- Uneven vehicle loading
- High crown in center of road
- High crosswinds
- Wheels out of alignment
- Loose or worn suspension components

Speed sensitive steering

The steering in your vehicle is speed sensitive. At high speeds, steering assist will decrease to improve steering feel. At lower speeds, maneuverability will be increased.

If the amount of effort required to steer your vehicle changes while driving at a constant vehicle speed, have the power steering system checked by your dealer or a qualified service technician.

AUTOMATIC TRANSMISSION OPERATION

Brake-shift interlock

This vehicle is equipped with a brake-shift interlock feature that prevents the gearshift lever from being moved from P (Park) when the ignition is in the RUN position unless brake pedal is depressed.

Driving

If you cannot move the gearshift lever out of P (Park) with ignition in the RUN position and the brake pedal depressed:

1. Apply the parking brake, turn ignition key to LOCK, then remove the key.
2. Insert the key and turn it to OFF. **Apply the brake pedal and shift to N (Neutral).**



When the key is in the ignition OFF position, the automatic transmission shift lever can be moved from the P (Park) position without the brake pedal depressed. To avoid unwanted vehicle movement, always set the parking brake.

3. Start the vehicle.

If it is necessary to use the above procedure to move the gearshift lever, it is possible that a fuse has blown or the vehicle's brakelamps are not operating properly. Refer to *Fuses and relays* in the *Roadside emergencies* chapter.



Do not drive your vehicle until you verify that the brakelamps are working.

If your vehicle gets stuck in mud or snow it may be rocked out by shifting from forward and reverse gears, stopping between shifts, in a steady pattern. Press lightly on the accelerator in each gear.

Do not rock the vehicle if the engine is not at normal operating temperature or damage to the transmission may occur.

Do not rock the vehicle for more than a few minutes or damage to the transmission and tires may occur or the engine may overheat.



Always set the parking brake fully and make sure the gearshift is latched in P (Park). Turn the ignition to the LOCK position and remove the key whenever you leave your vehicle.



If the parking brake is fully released, but the brake warning lamp remains illuminated, the brakes may not be working properly. See your dealer or a qualified service technician.

Driving with a 5-speed automatic transmission

Your automatic transmission electronically controls the shift feel by using an adaptive learning strategy. This feature is designed to increase

Driving

durability, and provide consistent shift feel over the life of the vehicle. It is normal for a new transmission to shift firmly. This operation is considered normal and will not affect function durability of the transmission. Once the vehicle is at operating temperature it may take several shifts at the same operating condition for the transmission to properly adapt. Over time the adaptive learning process will fully update transmission operation. The more varied the driving habits, speed and torque, the longer it may take to adapt but the more complete the process will be.

When the battery is disconnected or a new battery installed, the transmission must learn its adaptive strategy. As a result of this, the transmission may shift firmly. This operation is considered normal and will fully update transmission operation to its optimum shift feel.

Understanding gearshift positions

Pull the gearshift lever towards you and downward to the desired gear. The gearshift positions are displayed on the floor console next to the gearshift lever and on the instrument cluster.

 Hold the brake pedal down while you move the gearshift lever from P (Park) to another position. If you do not hold the brake pedal down, your vehicle may move unexpectedly and injure someone.

P (Park)

Always come to a complete stop before shifting into P (Park). Make sure the gearshift lever is securely latched in P (Park). This position locks the transmission and prevents the rear wheels from turning.

 Always set the parking brake fully and make sure the gearshift lever is latched in P (Park). Turn off the ignition whenever you leave your vehicle.

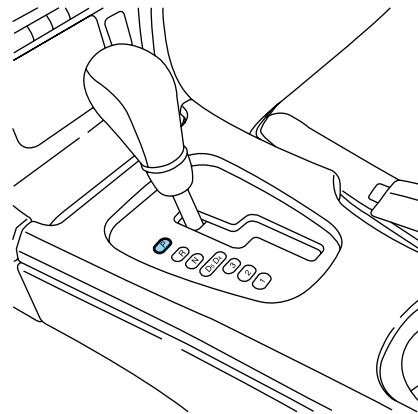

Driving

R (Reverse)

With the gearshift lever in R (Reverse), the vehicle will move backward. Always come to a complete stop before shifting into and out of R (Reverse).

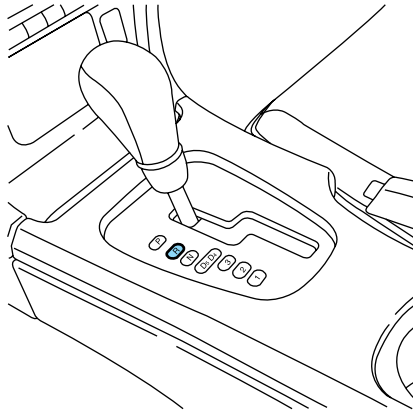

N (Neutral)

With the gearshift lever in N (Neutral), the vehicle can be started and is free to roll. Hold the brake pedal down while in this gear.

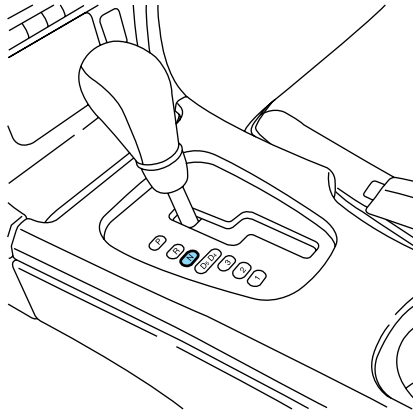

Drive 5 (Overdrive)

The normal driving position for the best fuel economy. Transmission operates in gears One through Five.

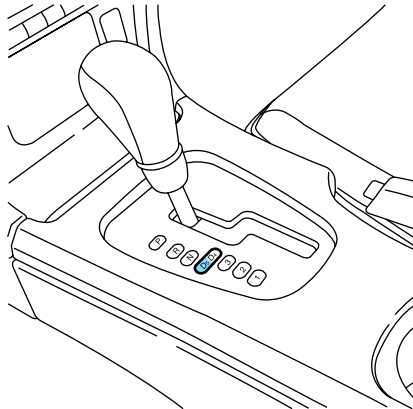

Drive 4 (Drive)

Transmission operates in gears One through Four. Drive 4 (Drive) provides engine braking in 4th gear and is useful when:

- driving with a heavy load.
- towing a trailer up or down steep hills.
- additional engine downhill braking is desired. If towing a trailer, refer to *Driving while you tow* in the *Trailer Towing* section of this chapter.

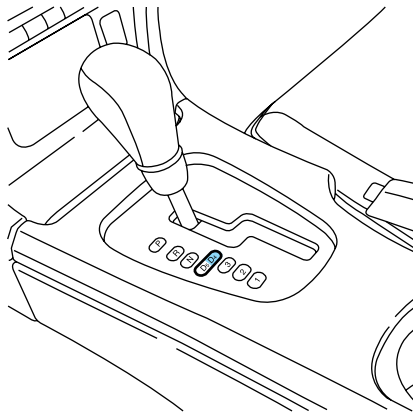

Upshifts into Overdrive can be made by shifting to D5. Selecting 4

(Drive) at higher speeds causes the transmission to shift to 4th gear. Selecting D4 from lower speeds will cause the transmission to upshift at the proper speed.

Driving

3 (Third)

Transmission operates in third gear only. Selecting 3 (Third) provides engine braking.

Upshifts can be made by shifting to 4 (Drive) or 5 (Overdrive). Selecting 3 (Third) at higher speeds causes the transmission to shift to a lower gear, and will shift to 3 (Third) after vehicle decelerates to the proper speed.

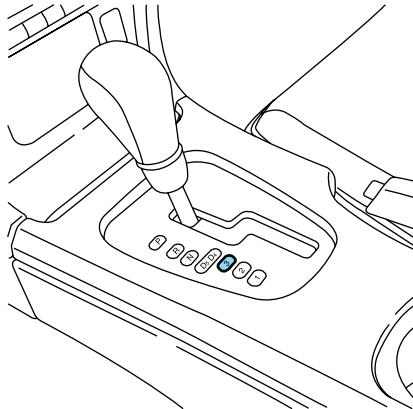

2 (Second)

Use 2 (Second) to start-up on slippery roads or to provide additional engine braking on downgrades.

Upshifts can be made by shifting to 3 (Third), 4 (Drive) or 5 (Overdrive). Selecting 2 (Second) at higher speeds causes the transmission to shift to a lower gear, and will shift to 2 (Second) after vehicle decelerates to the proper speed.

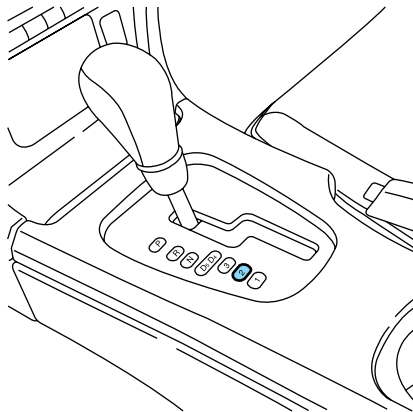

1 (First)

Use 1 (Low) to provide maximum engine braking on steep downgrades.

Upshifts can be made by shifting to 2 (Second), 3 (Third), 4 (Drive) or 5 (Overdrive). Selecting 1 (Low) at higher speeds causes the transmission to shift to a lower gear, and will shift to 1 (Low) after vehicle decelerates to the proper speed.

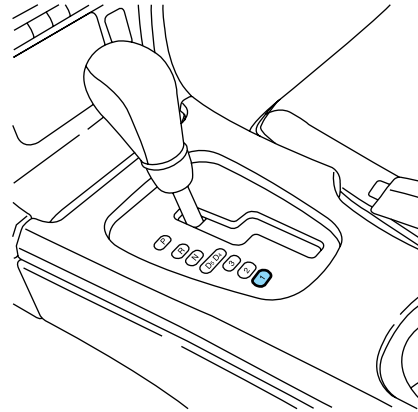

DRIVING THROUGH WATER

Do not drive quickly through standing water, especially if the depth is unknown. Traction or brake capability may be limited and if the ignition system gets wet, your engine may stall. Water may also enter your engine's air intake and severely damage your engine.

If driving through deep or standing water is unavoidable, proceed very slowly. Never drive through water that is higher than the bottom of the hubs (for trucks) or the bottom of the wheel rims (for cars).

Once through the water, always try the brakes. Wet brakes do not stop the vehicle as effectively as dry brakes. Drying can be improved by moving your vehicle slowly while applying light pressure on the brake pedal.

Driving through deep water where the transmission vent tube is submerged may allow water into the transmission and cause internal transmission damage. Have the fluid checked and, if water is found, replace the fluid.

VEHICLE LOADING

Before loading a vehicle, familiarize yourself with the following terms:

- **Base Curb Weight:** Weight of the vehicle including any standard equipment, fluids, lubricants, etc. It does not include occupants or aftermarket equipment.
- **Payload:** Combined maximum allowable weight of cargo, occupants and optional equipment. The payload equals the gross vehicle weight rating minus base curb weight.

Driving

- **GVW (Gross Vehicle Weight):** Base curb weight plus payload weight. The GVW is not a limit or a specification.
- **GVWR (Gross Vehicle Weight Rating):** Maximum permissible total weight of the base vehicle, occupants, optional equipment and cargo. The GVWR is specific to each vehicle and is listed on the Safety Certification Label on the driver's door pillar.
- **GAWR (Gross Axle Weight Rating):** Carrying capacity for each axle system. The GAWR is specific to each vehicle and is listed on the Safety Certification Label on the driver's door pillar.
- **GCW (Gross Combined Weight):** The combined weight of the towing vehicle (including occupants and cargo) and the loaded trailer.
- **GCWR (Gross Combined Weight Rating):** Maximum permissible combined weight of towing vehicle (including occupants and cargo) and the loaded trailer
- **Maximum Trailer Weight Rating:** Maximum weight of a trailer the vehicle is permitted to tow. The maximum trailer weight rating is determined by subtracting the vehicle curb weight for each engine/transmission combination, any required option weight for trailer towing and the weight of the driver from the GCWR for the towing vehicle.
- **Maximum Trailer Weight:** Maximum weight of a trailer the loaded vehicle (including occupants and cargo) is permitted to tow. It is determined by subtracting the weight of the loaded trailer towing vehicle from the GCWR for the towing vehicle.
- **Trailer Weight Range:** Specified weight range that the trailer must fall within that ranges from zero to the maximum trailer weight rating.

Remember to figure in the tongue load of your loaded trailer when figuring the total weight.



Do not exceed the GVWR or the GAWR specified on the certification label.

Do not use replacement tires with lower load carrying capacities than the originals because they may lower the vehicle's GVWR and GAWR limitations. Replacement tires with a higher limit than the originals do not increase the GVWR and GAWR limitations.

The Safety Certification Label, found on the driver's door pillar, lists several important vehicle weight rating limitations. Before adding any additional equipment, refer to these limitations. If you are adding weight to the front of your vehicle, (potentially including weight added to the

Driving

cab), the weight added should not exceed the front axle reserve capacity (FARC). Additional frontal weight may be added to the front axle reserve capacity provided you limit your payload in other ways (i.e. restrict the number of occupants or amount of cargo carried).

Always ensure that the weight of occupants, cargo and equipment being carried is within the weight limitations that have been established for your vehicle including both gross vehicle weight and front and rear gross axle weight rating limits. Under no circumstance should these limitations be exceeded.



Exceeding any vehicle weight rating limitation could result in serious damage to the vehicle loss of vehicle control, vehicle rollover, and/or personal injury.

TRAILER TOWING

Trailer towing with your vehicle may require the use of a trailer tow option package. To ensure that the electrical system is not damaged, your vehicle will require a trailer tow package which includes a trailer tow module and the necessary wiring to connect the trailer tow module to the electrical system and to the trailer. This option is available through your dealer or through Ford Customer Service Division. Please refer to *Preparing to tow* for further information.

Trailer towing puts additional loads on your vehicle's engine, transmission, axle, brakes, tires, and suspension. For your safety and to maximize vehicle performance, be sure to use the proper equipment while towing.

Follow these guidelines to ensure safe towing procedure:

- Stay within your vehicle's load limits. If exceeded, cargo should be removed from the trailer and/or the vehicle until all weights are within specified limits.
- Thoroughly prepare your vehicle for towing. Refer to *Preparing to tow* in this chapter.
- Use extra caution when driving while trailer towing. Refer to *Driving while you tow* in this chapter.
- Service your vehicle more frequently if you tow a trailer. Refer to the severe duty schedule in the scheduled maintenance guide.
- Do not tow a trailer until your vehicle has been driven at least 800 km (500 miles).
- Refer to the instructions included with towing accessories for the proper installation and adjustment specifications.

Driving

Do not exceed the maximum loads listed on the Certification label. For load specification terms found on the label, refer to *Vehicle loading* in this chapter. Remember to figure in the tongue load of your loaded trailer when figuring the total weight.

Engine - 3.9L	Kg (Lbs.)
Maximum GCWR	2472 (5331)
Maximum trailer weight rating	454 (1000)
Maximum trailer tongue weight	45 (100)



Towing trailers beyond the maximum recommended gross trailer weight exceeds the limit of the vehicle and could result in engine damage, transmission damage, structural damage, loss of control and personal injury.

Preparing to tow

Use the proper equipment for towing a trailer and make sure it is properly attached to your vehicle. See your dealer or a reliable trailer dealer if you require assistance.

Hitches

Do not use hitches that clamp onto the vehicle bumper. Use a load carrying hitch. You must distribute the load in your trailer so that 10–15% of the total weight of the trailer is on the tongue.

Safety chains

Always connect the trailer's safety chains to the frame or hook retainers of the vehicle hitch. To connect the trailer's safety chains, cross the chains under the trailer tongue and allow slack for turning corners.

If you use a rental trailer, follow the instructions that the rental agency gives to you.

Do not attach safety chains to the bumper.

Trailer brakes

Electric brakes and manual, automatic or surge-type trailer brakes are safe if installed properly and adjusted to the manufacturer's specifications. The trailer brakes must meet local and Federal regulations.



Do not connect a trailer's hydraulic brake system directly to your vehicle's brake system. Your vehicle may not have enough braking power and your chances of having a collision greatly increase.

The braking system of the tow vehicle is rated for operation at the GVWR not GCWR.

Trailer lamps

Trailer lamps are required on most towed vehicles. Make sure your trailer lamps conform to local and Federal regulations. See your dealer or trailer rental agency for proper instructions and equipment for hooking up trailer lamps.

Driving while you tow

When towing a trailer:

- Turn off the speed control. The speed control may shut off automatically when you are towing on long, steep grades.
- Consult your local motor vehicle speed regulations for towing a trailer.
- Shift out of D5 (Overdrive) and into D4 (Drive) or a lower gear when towing up or down steep hills. This will eliminate excessive downshifting and upshifting for optimum fuel economy and transmission cooling.
- Anticipate stops and brake gradually.

Servicing after towing

If you tow a trailer for long distances, your vehicle will require more frequent service intervals. Refer to your scheduled maintenance guide for more information.

Trailer towing tips

- Practice turning, stopping and backing up before starting on a trip to get the feel of the vehicle trailer combination. When turning, make wider turns so the trailer wheels will clear curbs and other obstacles.
- Allow more distance for stopping with a trailer attached.
- If you are driving down a long or steep hill, shift to a lower gear. Do not apply the brakes continuously, as they may overheat and become less effective.
- The trailer tongue weight should be 10–15% of the loaded trailer weight.
- After you have traveled 80 km (50 miles), thoroughly check your hitch, electrical connections and trailer wheel lug nuts.
- To aid in engine/transmission cooling and A/C efficiency during hot weather while stopped in traffic, place the gearshift lever in P (Park).
- Vehicles with trailers should not be parked on a grade. If you must park on a grade, place wheel chocks under the trailer's wheels.

Driving

Launching or retrieving a boat

Disconnect the wiring to the trailer before backing the trailer into the water. Reconnect the wiring to the trailer after the trailer is removed from the water.

When backing down a ramp during boat launching or retrieval:

- do not allow the static water level to rise above the bottom edge of the rear bumper.
- do not allow waves to break higher than 15 cm (6 inches) above the bottom edge of the rear bumper.

Exceeding these limits may allow water to enter vehicle components:

- causing internal damage to the components.
- affecting driveability, emissions and reliability.

Replace the rear axle lubricant any time the axle has been submerged in water. Rear axle lubricant quantities are not to be checked or changed unless a leak is suspected or repair required.

RECREATIONAL TOWING (ALL WHEELS ON THE GROUND)

Follow these guidelines for your specific powertrain combination to tow your vehicle with all four wheels on the ground (such as behind a recreational vehicle).

These guidelines are designed to ensure that your transmission is not damaged due to insufficient lubrication.

All Rear Wheel Drive (RWD) vehicles:

This applies to all cars and 4x2 trucks/sport utilities with rear wheel drive capability.

- Place the transmission in N (Neutral)
- Maximum speed is 56 km/h (35 mph)
- Maximum distance is 80 km (50 miles)

If a distance of 80 km (50 miles) or a speed of 56 km/h (35 mph) must be exceeded, you must disconnect the driveshaft. Ford recommends the driveshaft be removed/installed only by a qualified technician. See your local dealer for driveshaft removal/installation.

Improper removal/installation of the driveshaft can cause transmission fluid loss, damage to the driveshaft and internal transmission components.

Roadside Emergencies

GETTING ROADSIDE ASSISTANCE

To fully assist you should you have a vehicle concern, Ford Motor Company offers a complimentary roadside assistance program. This program is separate from the New Vehicle Limited Warranty. The service is available:

- 24-hours, seven days a week
- for the New Vehicle Limited Warranty period of three years or 60,000 km (36,000 miles), whichever occurs first on Ford and Mercury vehicles, and four years or 80,000 km (50,000 miles) on Lincoln vehicles.

Roadside assistance will cover:

- changing a flat tire
- jump-starts
- lock-out assistance
- limited fuel delivery
- towing of your disabled vehicle to the nearest Ford Motor Company dealership, or your selling dealer if within 56.3 km (35 miles) of the nearest Ford Motor Company dealership (one tow per disablement). Even non-warranty related tows, like accidents or getting stuck in the mud or snow, are covered (some exclusions apply, such as impound towing or repossession).

Canadian customers refer to your Owner Information Guide for information on:

- coverage period
- exact fuel amounts
- towing of your disabled vehicle
- emergency travel expense reimbursement
- travel planning benefits

Using roadside assistance

Complete the roadside assistance identification card and place it in your wallet for quick reference. In the United States, this card is found in the Owner Guide portfolio in the glove compartment in Ford vehicles and is mailed to you if you own a Mercury or Lincoln. In Canada, the card is found in the Owner Information Guide in the glove compartment.

U.S. Ford or Mercury vehicle customers who require roadside assistance, call 1-800-241-3673; Lincoln vehicle customers call 1-800-521-4140.

Roadside Emergencies

Canadian customers who require roadside assistance, call 1-800-665-2006.

If you need to arrange roadside assistance for yourself, Ford Motor Company will reimburse a reasonable amount. To obtain reimbursement information, U.S. Ford or Mercury vehicles customers call 1-800-241-3673; Lincoln vehicle customers call 1-800-521-4140.

Canadian customers who need to obtain reimbursement information, call 1-800-665-2006.

Roadside coverage beyond basic warranty

In the United States, you may purchase additional roadside assistance coverage beyond this period through the Ford Auto Club by contacting your Ford or Lincoln Mercury dealer.

Similarly in Canada, for uninterrupted Roadside Assistance coverage, you may purchase extended coverage prior to your Basic Warranty's Roadside Assistance expiring. For more information and enrollment, contact 1-877-294-2582 or visit our website at www.ford.ca.

HAZARD FLASHER

Use only in an emergency to warn traffic of vehicle breakdown, approaching danger, etc. The hazard flashers can be operated when the ignition is off.

- The hazard lights control is located on top of the steering column.
- Depress hazard lights control to activate all hazard flashers simultaneously.
- Depress control again to turn the flashers off.

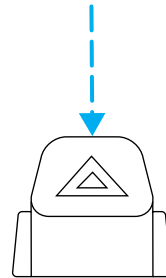

FUEL PUMP SHUT-OFF SWITCH

The fuel pump shut-off switch is a device intended to stop the electric fuel pump when your vehicle has been involved in a substantial jolt.

After a collision, if the engine cranks but does not start, the fuel pump shut-off switch may have been activated.

Roadside Emergencies

The fuel pump shut-off switch is located in the driver's foot well, behind the kick panel. The reset button (RED) for the fuel pump shut-off switch is accessible through an opening in the kick panel.

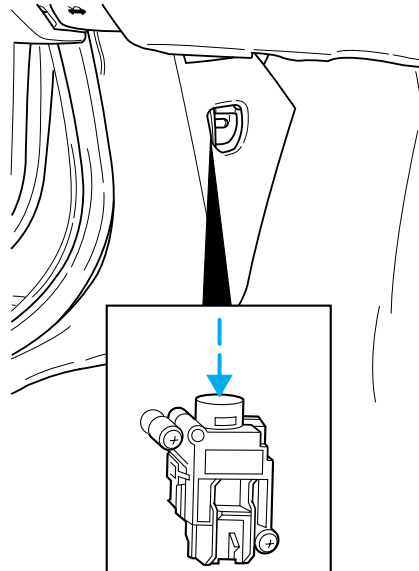

Use the following procedure to reset the fuel pump shut-off switch.

1. Turn the ignition to the OFF position.
2. Check the fuel system for leaks.
3. If no fuel leak is apparent, reset the fuel pump shut-off switch by pushing in on the reset button.
4. Turn the ignition to the RUN position. Pause for a few seconds and return the key to the OFF position.
5. Make a further check for leaks in the fuel system.

FUSES AND RELAYS

Fuses

If electrical components in the vehicle are not working, a fuse may have blown. Blown fuses are identified by a broken wire within the fuse. Check the appropriate fuses before replacing any electrical components.

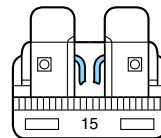

Roadside Emergencies

Note: Always replace a fuse with one that has the specified amperage rating. Using a fuse with a higher amperage rating can cause severe wire damage and could start a fire.

Standard fuse amperage rating and color

COLOR					
Fuse rating	Mini fuses	Standard fuses	Maxi fuses	Cartridge maxi fuses	Fuse link cartridge
2A	Grey	Grey	—	—	—
3A	Violet	Violet	—	—	—
4A	Pink	Pink	—	—	—
5A	Tan	Tan	—	—	—
7.5A	Brown	Brown	—	—	—
10A	Red	Red	—	—	—
15A	Blue	Blue	—	—	—
20A	Yellow	Yellow	Yellow	Blue	Blue
25A	Natural	Natural	—	—	—
30A	Green	Green	Green	Pink	Pink
40A	—	—	Orange	Green	Green
50A	—	—	Red	Red	Red
60A	—	—	Blue	—	Yellow
70A	—	—	Tan	—	Brown
80A	—	—	Natural	—	Black

Passenger compartment fuse panel

The fuse panel is located on the right-hand side kick panel. Remove the panel cover to access the fuses.

To remove a fuse use the fuse puller tool provided on the fuse panel cover.

Roadside Emergencies

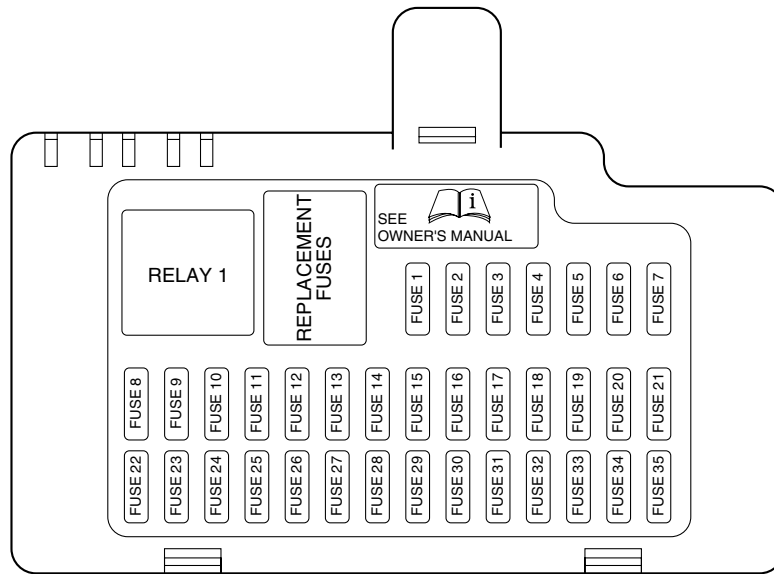

The fuses are coded as follows.

Fuse/Relay Location	Fuse Amp Rating	Passenger Compartment Fuse Panel Description
1	5A	Starter relay coil
2	5A	Radio start signal
3	5A	ABS module
4	5A	PCM coil, Cluster and fuel pump relay
5	5A	Autolamp system, FEM, T/A switch
6	10A	OBD II
7	5A	PCM, RKE, Sunload sensor
8	5A	Right-hand turn/park/side marker
9	15A	Right-hand headlamp
10	5A	Left-hand turn/park/side marker
11	15A	Left-hand headlamp
12	10A	Pad switch

Roadside Emergencies

Fuse/Relay Location	Fuse Amp Rating	Passenger Compartment Fuse Panel Description
13	5A	Cluster
14	10A	Air bag, Vehicle ID
15	5A	Not used (spare)
16	5A	Not used (spare)
17	5A	Alternator and air bag warning
18	20A	Radio
19	20A	Tilt/Tele motors
20	10A	FEM, DATC, Cluster
21	10A	Not used (spare)
22	10A	Not used (spare)
23	10A	Not used (spare)
24	5A	PATS transceiver
25	10A	Washer pump
26	3A	Windshield wiper relay
27	10A	Radio, Cellphone
28	10A	Not used (spare)
29	5A	DATC
30	5A	FEM VBATT2
31	10A	Map lamps, Interior lighting, S/JB
32	20A	Cigar lighter
33	10A	FEM, Ill M.
34	5A	Outside mirror
35	5A	DGB brake pedal switch, Stoplamp switch

Roadside Emergencies

Front power distribution box

The front power distribution box is located in the engine compartment. The power distribution box contains high-current fuses that protect your vehicle's main electrical systems from overloads.

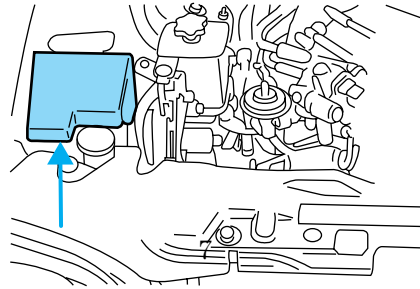

Always disconnect the battery before servicing high current fuses.



To reduce risk of electrical shock, always replace the cover to the Power Distribution Box before reconnecting the battery or refilling fluid reservoirs.

If the battery has been disconnected and reconnected, refer to the *Battery* section of the *Maintenance and specifications* chapter.

Roadside Emergencies

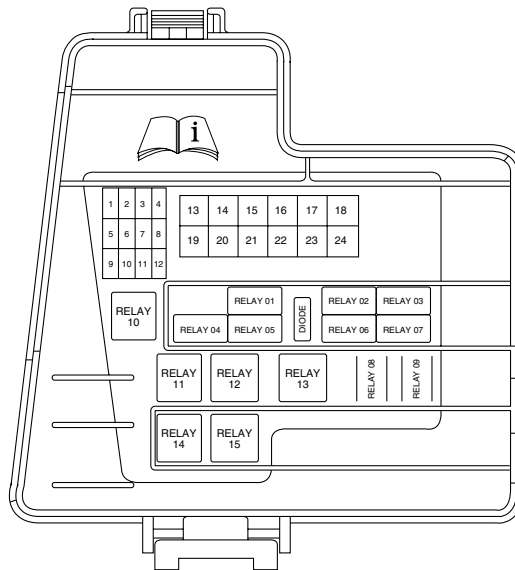

The high-current fuses are coded as follows.

Fuse/Relay Location	Fuse Amp Rating	Power Distribution Box Description
1	10A*	A/C clutch
2	15A*	Heated wiper park
3	10A*	Park lamp
4	15A*	Horn
5	20A*	Fuel injectors
6	15A*	Transmission solenoid
7	—	Not used
8	20A*	Power point
9	—	Not used
10	15A*	IAC solenoid
11	15A*	HEGO's
12	10A*	Coil-on-plug
13	—	Not used

Roadside Emergencies

Fuse/Relay Location	Fuse Amp Rating	Power Distribution Box Description
14	30A**	ABS module power
15	—	Not used
16	30A**	Blower motor
17	—	Not used
18	40A**	PCM
19	—	Not used
20	—	Not used
21	30A**	Starter solenoid
22	30A**	ABS motor
23	—	Not used (fuse plug)
24	30A**	Wiper relay
Relay 01	Mini Relay	Wiper HI/LO
Relay 02	Mini Relay	Wiper park
Relay 03	Mini Relay	Coil-on-plug and HEGOs
Relay 04	Mini Relay	Heated wiper park relay
Relay 05	Mini Relay	Auxiliary coolant pump (V8 engines)
Relay 06	Mini Relay	Horns
Relay 07	—	Not used
Relay 08	Mini Relay	A/C clutch
Relay 09	—	Not used
Relay 10	Standard Relay	Blower motor
Relay 11	Standard Relay	Wipers
Relay 12	—	Not used
Relay 13	—	Not used
Relay 14	Standard Relay	PCM
Relay 15	Standard Relay	Starter motor
Diode	—	Not used
*Mini fuses **Cartridge fuses		

Roadside Emergencies

Rear power distribution box

The rear power distribution box is located in the luggage compartment under the spare tire well cover. The power distribution box contains high-current fuses that protect your vehicle's main electrical systems from overloads.

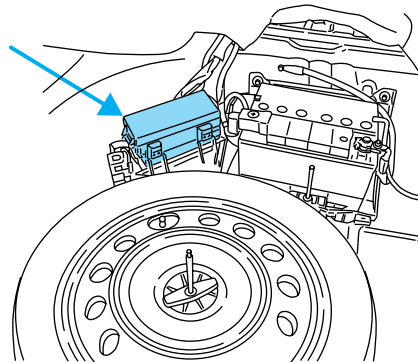

Always disconnect the battery before servicing high current fuses.



To reduce risk of electrical shock, always replace the cover to the Power Distribution Box before reconnecting the battery or refilling fluid reservoirs.

If the battery has been disconnected and reconnected, refer to the *Battery* section of the *Maintenance and specifications* chapter.

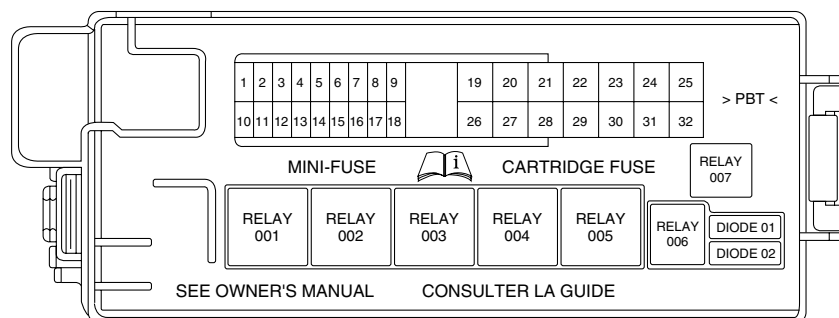

Roadside Emergencies

The high-current fuses are coded as follows.

Fuse/Relay Location	Fuse Amp Rating	Power Distribution Box Description
1	15A*	Decklid solenoid
2	5A*	License plate lamp
3	10A*	Left rear turn and stop lamp
4	10A*	Luggage compartment lamp
5	—	Not used
6	10A*	Back-up lamps
7	10A*	Right rear turn and stop lamp
8	5A*	Center high-mounted stop lamp
9	—	Not used
10	—	Not used
11	—	Not used
12	5A*	REM logic (if equipped)
13	—	Not used
14	5A*	Convertible top relay coil
15	5A*	Alternator sense
16	—	Not used
17	15A*	Fuel pump
18	20A*	Subwoofer amplifier
19	30A**	Driver power seat
20	30A**	FEM - Left front window
21	—	Not used
22	20A**	Ignition switch
23	30A**	SSP4
24	30A**	SSP3
25	40A**	P-J/B
26	30A**	Passenger power seat
27	30A**	SSP1
28	30A**	REM -Right front window
29	30A**	Rear defroster
30	—	Not used

Roadside Emergencies

Fuse/Relay Location	Fuse Amp Rating	Power Distribution Box Description
31	—	Not used
32	30A**	SSP2
Relay 001	Full ISO	SSP1
Relay 002	Full ISO	SSP4
Relay 003	Full ISO	Rear defroster
Relay 004	Full ISO	SSP3
Relay 005	Full ISO	SSP2
Relay 006	—	Not used
Relay 007	1/2 ISO	Fuel pump
Diode 01	—	Not used
Diode 02	1A	Fuel pump motor

*Mini fuses **Maxi fuses

CHANGING THE TIRES

If you get a flat tire while driving, do not apply the brake heavily. Instead, gradually decrease your speed. Hold the steering wheel firmly and slowly move to a safe place on the side of the road.



The use of tire sealants is not recommended and may compromise the integrity of your tires.

Temporary spare tire information

Your vehicle may have a temporary or full-size spare tire. The temporary spare tire for your vehicle is labeled as such. It is smaller than a regular tire and is designed for emergency use only. Drive cautiously and replace the temporary spare tire as soon as possible.



If you use the temporary spare tire continuously or do not follow these precautions, the tire could fail, causing you to lose control of the vehicle, possibly injuring yourself or others.

When driving with the temporary spare tire **do not:**

- exceed 80 km/h (50 mph)
- load the vehicle beyond maximum vehicle load rating listed on the Safety Compliance Label

Roadside Emergencies

- tow a trailer
- use tire chains
- drive through an automatic car wash, because of the vehicle's reduced ground clearance
- try to repair the temporary spare tire or remove it from its wheel
- drive for long distances when the temporary-use spare is on
- use the wheel for any other type of vehicle
- use more than one temporary spare tire at a time

Use of a temporary spare tire at any one wheel location can lead to impairment of the following:

- Handling, stability and braking performance
- Comfort and noise
- Ground clearance and parking at curbs
- Winter driving capability

Tire change procedure



To prevent the vehicle from moving when you change a tire, be sure the parking brake is set, then block (in both directions) the wheel that is diagonally opposite (other side and end of the vehicle) to the tire being changed.



If the vehicle slips off the jack, you or someone else could be seriously injured.

1. Park on a level surface, activate hazard flashers and set parking brake.
2. Place gearshift lever in P (Park), turn engine OFF, and block the diagonally opposite wheel.

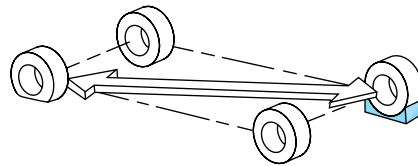

Roadside Emergencies

3. Lift the trunk cargo cover and remove the spare tire, jack and **tool bag with lug wrench.**

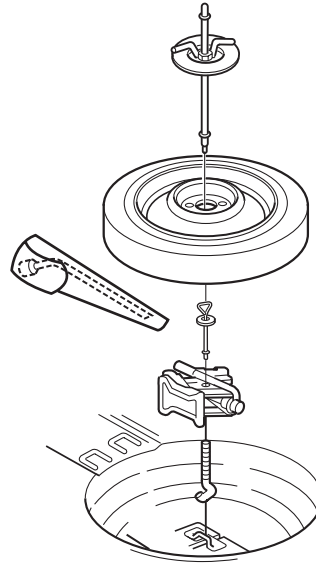

4. Loosen each wheel lug nut one-half turn counterclockwise but do not remove them until the wheel is raised off the ground.

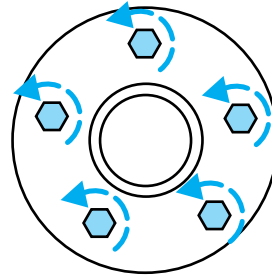

Roadside Emergencies

5. Put the jack in the jack notch next to the tire you are changing. Turn the jack handle clockwise until the wheel is completely off the ground.

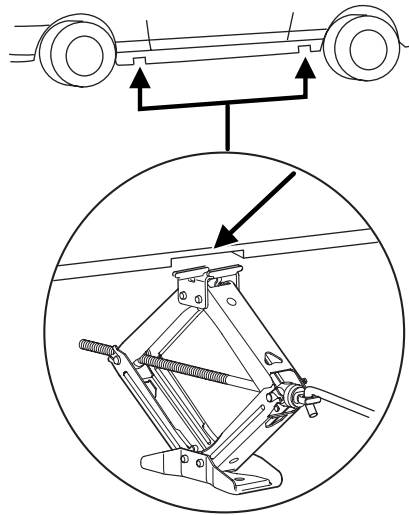

Never use the rear differential as a jacking point.

 To lessen the risk of personal injury, do not put any part of your body under the vehicle while changing a tire. Do not start the engine when your vehicle is on the jack. The jack is only meant for changing the tire.

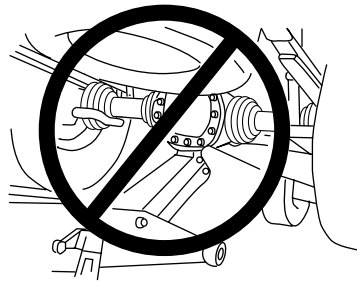

6. Remove the lug nuts with the lug wrench.
7. Replace the flat tire with the spare tire, making sure the valve stem is facing outward. Reinstall lug nuts until the wheel is snug against the hub. Do not fully tighten the lug nuts until the wheel has been lowered. If you are using the temporary tire, the lug nut washers will not appear to be flush with the rim. This is normal only when using the temporary spare tire.
8. Lower the wheel by turning the jack handle counterclockwise.

Roadside Emergencies

9. Remove the jack and fully tighten the lug nuts in the order shown.

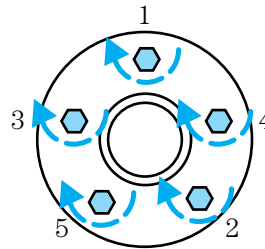

Note: The jack cannot be properly stowed when a full size tire is placed here. Secure the jack and the temporary spare tire as shown after the flat tire has been fixed.

10. Put flat tire, jack away. Stow the lug wrench in the bag along side of the tire. Make sure jack is fastened so it does not rattle when you drive.

11. Unblock the wheels.

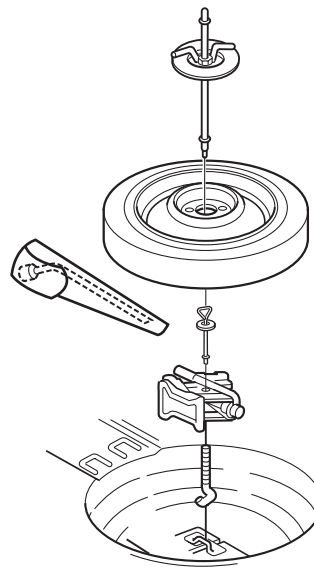

Anti-theft lug nuts (if equipped)

If your vehicle is equipped with this feature, one of the lug nuts on each wheel must be removed and replaced with a special key. The key and registration card are attached to the lug wrench and stored with the spare tire. If you lose the key, send the registration card to the manufacturer (not the dealer) to get a replacement key. If the lug wrench/lug nut key assembly is lost, see your nearest Ford or Lincoln Mercury dealer who has access to the master set of keys. **Do not use an impact wrench with the anti-theft key.**

Roadside Emergencies

To remove the anti-theft lug nut:

1. Insert the key over the locking lug nut. Make sure you hold the key square to the lug nut. If you hold the key at an angle, you could damage the key and the lug nut.

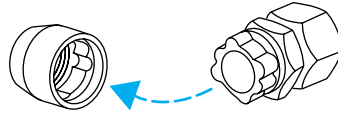

2. Place the lug nut wrench over the lug nut key and apply pressure on the key with the wrench.
3. Turn the wrench in a counterclockwise direction to remove the lug nut.

To install the anti-theft lug nut:

1. Insert the key over the locking lug nut.
2. Place the lug nut wrench over the lug nut key and apply pressure on the key with the wrench.
3. Install the lug nut by turning the wrench clockwise.

JUMP STARTING YOUR VEHICLE



The gases around the battery can explode if exposed to flames, sparks, or lit cigarettes. An explosion could result in injury or vehicle damage.



Batteries contain sulfuric acid which can burn skin, eyes and clothing, if contacted.

Do not attempt to push-start your vehicle. Automatic transmissions do not have push-start capability; also, the catalytic converter may become damaged.

Preparing your vehicle

Your battery is located in the trunk of your vehicle.

When the battery is disconnected or a new battery is installed, the transmission must relearn its shift strategy. As a result, the transmission may have firm and/or soft shifts. This operation is considered normal and will not affect function or durability of the transmission. Over time, the adaptive learning process will fully update transmission operation.

1. **Use only a 12-volt supply to start your vehicle.**
2. Do not disconnect the battery of your disabled vehicle as this could damage the vehicle's electrical system. Keep the battery vent hose attached at all times.

Roadside Emergencies

3. Park the booster vehicle close to the trunk of your disabled vehicle making sure the two vehicles **do not** touch. Set the parking brake on both vehicles and stay clear of the engine cooling fan and other moving parts.
4. Check all battery terminals and remove any excessive corrosion before you attach the battery cables. Ensure the vent caps are tight and level.
5. Turn the heater fan on in both vehicles to protect any electrical surges. Turn all other accessories off.

Connecting the jumper cables

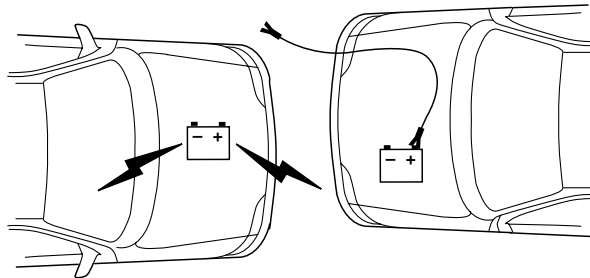

1. Connect the positive (+) booster cable to the positive (+) terminal of the discharged battery.

Note: In the illustrations, *lightning bolts* are used to designate the assisting (boosting) battery.

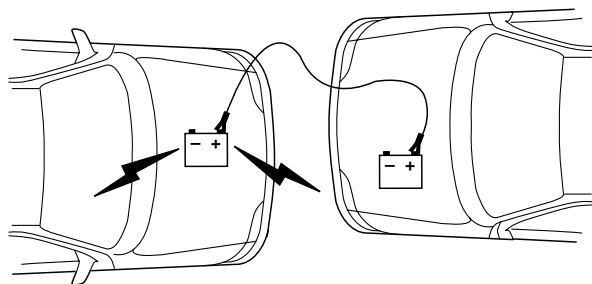

2. Connect the other end of the positive (+) cable to the positive (+) terminal of the assisting battery.

Roadside Emergencies

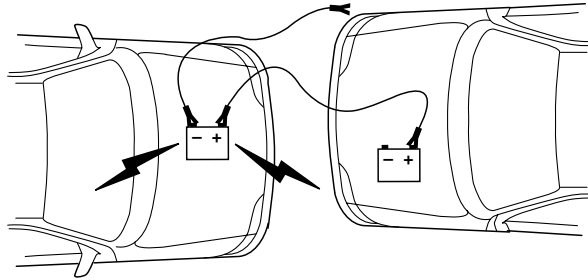

3. Connect the negative (-) cable to the negative (-) terminal of the assisting battery.

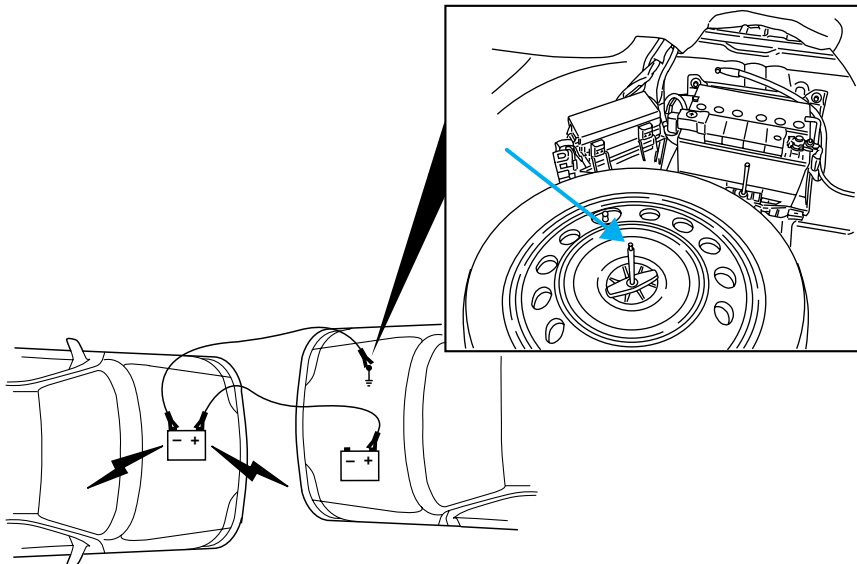

4. Make the final connection of the negative (-) cable to the spare tire tie-down stud. (Your vehicle may be equipped with a plastic cap on top of the tire tie-down stud. This cap must be removed prior to attaching the cable to the stud.)

Roadside Emergencies

 Do not connect the end of the second cable to the negative (-) terminal of the battery to be jumped. A spark may cause an explosion of the gases that surround the battery.

5. Ensure that the cables are clear of fan blades, belts, moving parts of both engines, or any fuel delivery system parts.

Jump starting

1. Start the engine of the booster vehicle and run the engine at moderately increased speed.
2. Start the engine of the disabled vehicle.
3. Once the disabled vehicle has been started, run both engines for an additional three minutes before disconnecting the jumper cables.

Removing the jumper cables

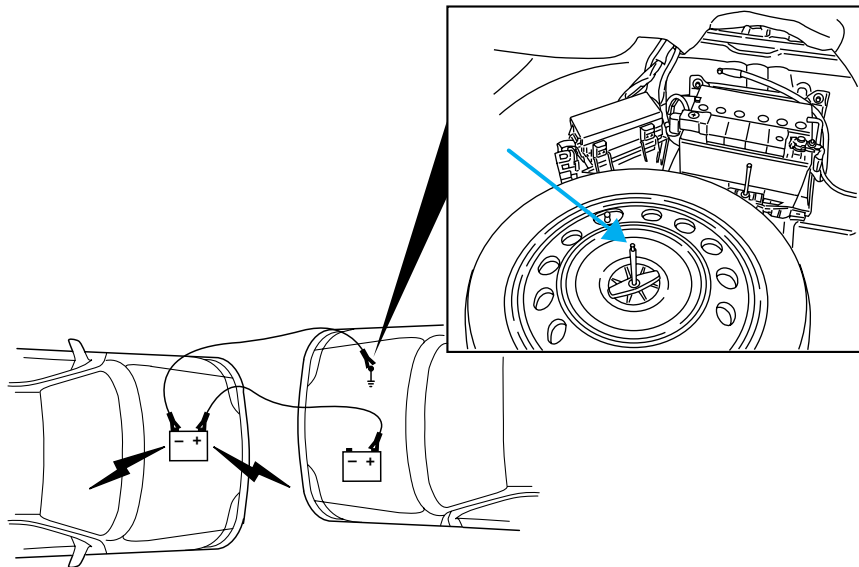

Remove the jumper cables in the reverse order that they were connected.

1. Remove the jumper cable from the spare tire tie-down stud.

Roadside Emergencies

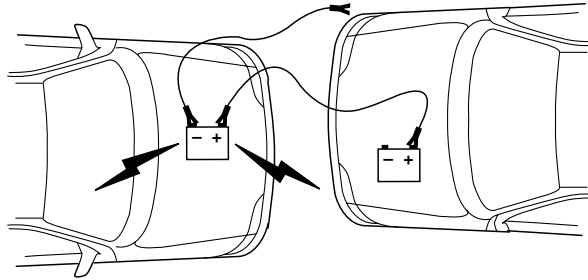

2. Remove the jumper cable on the negative (-) connection of the booster vehicle's battery.

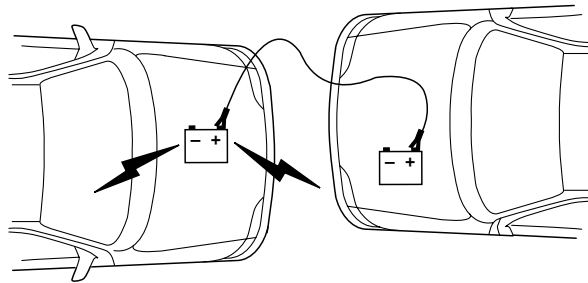

3. Remove the jumper cable from the positive (+) terminal of the booster vehicle's battery.

Roadside Emergencies

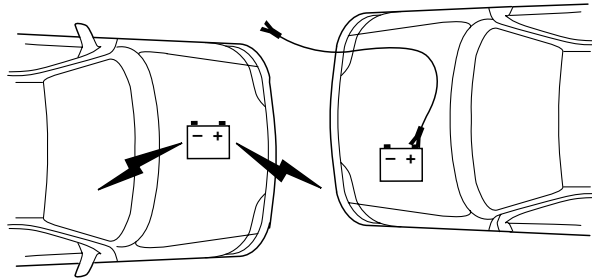

4. Remove the jumper cable from the positive (+) terminal of the disabled vehicle's battery.

After the disabled vehicle has been started and the jumper cables removed, allow it to idle for several minutes so the engine computer can *relearn* its idle conditions.

Roadside Emergencies

WRECKER TOWING

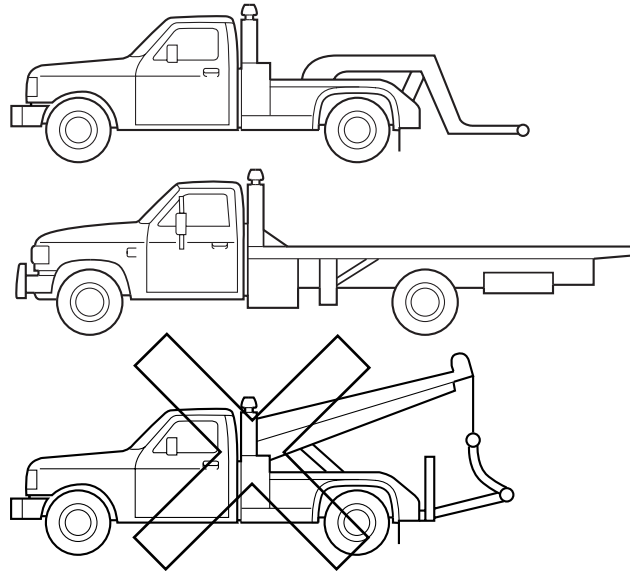

If you need to have your vehicle towed, contact a professional towing service or, if you are a member of a roadside assistance program, your roadside assistance service provider.

It is recommended that your vehicle be towed with a wheel lift or flatbed equipment. Do not tow with a slingbelt. Ford Motor Company has not approved a slingbelt towing procedure.

If the vehicle is towed by other means or incorrectly, vehicle damage may occur.

Ford Motor Company produces a towing manual for all authorized tow truck operators. Have your tow truck operator refer to this manual for proper hook-up and towing procedures for your vehicle.

Customer Assistance

GETTING THE SERVICES YOU NEED

At home

Ford Motor Company and Ford of Canada have authorized dealerships to service your vehicle. It is preferred that you return to the authorized dealer where your vehicle was purchased when warranty repairs are needed. However, you may also take your vehicle to another Ford Motor Company or Ford of Canada dealership authorized for warranty repairs. Certain warranty repairs require special training though, so not all dealers are authorized to perform all warranty repairs. That means that depending on the warranty repair needed, the vehicle may need to be taken to another dealer. If a particular dealership cannot assist you, then contact the Customer Relationship Center.

If you have questions or concerns, or are unsatisfied with the service you are receiving, follow these steps:

1. Contact your Sales Representative or Service Advisor at your selling/servicing dealership.
2. If your inquiry or concern remains unresolved, contact the Sales Manager or Service Manager at the dealership.
3. If the inquiry or concern cannot be resolved at the dealership level, please contact the Ford Customer Relationship Center.

Away from home

If you own a Ford or Mercury vehicle and are away from home when your vehicle needs service, or if you need more help than the dealership could provide, after following the steps described above, contact the Ford Customer Relationship Center to find an authorized dealership to help you.

In the United States:

Ford Motor Company
Customer Relationship Center
16800 Executive Plaza Drive
P.O. Box 6248
Dearborn, Michigan 48121
1-800-392-3673 (FORD)
(TDD for the hearing impaired: 1-800-232-5952)
www.ford.com

Customer Assistance

In Canada:
Customer Relationship Centre
Ford Motor Company of Canada, Limited
P.O. Box 2000
Oakville, Ontario L6J 5E4
1-800-565-3673 (FORD)
www.ford.ca

If you own a Lincoln vehicle and are away from home when your vehicle needs service, or if you need more help than the dealership could provide, after following the steps described above, contact the Ford Customer Relationship Center to find an authorized dealership to help you.

In the United States:
Ford Motor Company
Customer Relationship Center
16800 Executive Plaza Drive
P.O. Box 6248
Dearborn, Michigan 48121
1-800-521-4140
(TDD for the hearing impaired: 1-800-232-5952)
www.ford.com

In Canada:
Customer Relationship Centre
Ford Motor Company of Canada, Limited
P.O. Box 2000
Oakville, Ontario L6J 5E4
1-800-565-3673 (FORD)
www.ford.ca

In order to help you service your Ford or Lincoln Mercury vehicle, please have the following information available when contacting a Customer Relationship Center:

- Your telephone number (home and business)
- The name of the dealer and the city where the dealership is located
- The year and make of your vehicle
- The date of vehicle purchase
- The current odometer reading
- The vehicle identification number (VIN)

If you still have a complaint involving a warranty dispute, you may wish to contact the Dispute Settlement Board (U.S.).

Customer Assistance

In some states (in the U.S.) you must directly notify Ford in writing before pursuing remedies under your state's warranty laws. Ford is also allowed a final repair attempt in some states.

In the United States, a warranty dispute must be submitted to the Dispute Settlement Board before taking action under the Magnuson-Moss Warranty Act, or to the extent allowed by state law, before pursuing replacement or repurchase remedies provided by certain state laws. This dispute handling procedure is not required prior to enforcing state created rights or other rights which are independent of the Magnuson-Moss Warranty Act or state replacement or repurchase laws.

FORD EXTENDED SERVICE PLAN

You can get more protection for your new car or light truck by purchasing Ford Extended Service Plan (Ford ESP) coverage. Ford ESP is an optional service contract which is backed by Ford Motor Company or Ford Motor Service Company (in the U.S.) and Ford of Canada (in Canada). It provides the following:

- Benefits during the warranty period depending on the plan you purchase (such as: reimbursement for rentals; coverage for certain maintenance and wear items).
- Protection against covered repair costs after your Bumper-to-Bumper Warranty expires.

You may purchase Ford ESP from any participating Ford and Lincoln Mercury and Ford of Canada dealer. There are several plans available in various time, distance and deductible combinations which can be tailored to fit your own driving needs. Ford ESP also offers reimbursement benefits for towing and rental coverage.

When you buy Ford ESP, you receive Peace-of-Mind protection throughout the United States and Canada, provided by a network of more than 5,000 participating Ford or Lincoln Mercury and Ford of Canada dealers.

If you did not take advantage of the Ford Extended Service Plan at the time of purchasing your vehicle, you may still be eligible. Since this information is subject to change, please ask your dealer for complete details about Ford Extended Service Plan coverage options, or visit the Ford ESP website at www.ford-esp.com.

Customer Assistance

THE DISPUTE SETTLEMENT BOARD (U.S. ONLY)

The Dispute Settlement Board is:

- an independent, third-party arbitration program for warranty disputes.
- available free to owners and lessees of qualifying Ford Motor Company vehicles.

The Dispute Settlement Board may not be available in all states. Ford Motor Company reserves the right to change eligibility limitations, modify procedures and/or to discontinue this service without notice and without incurring obligations per applicable state law.

What kinds of cases does the Board review?

Unresolved warranty repair concerns or vehicle performance concerns as on Ford and Lincoln Mercury cars and Ford and Lincoln Mercury light trucks which are within the terms of any applicable written new vehicle warranty are eligible for review, except those involving:

- a non-Ford product
- a non-Ford dealership
- sales disputes between customer and dealer except those associated with warranty repairs or concerns with the vehicle's performance as designed
- a request for reimbursement of consequential expenses unless a service or product concern is being reviewed
- items not covered by the New Vehicle Limited Warranty (including maintenance and wear items)
- alleged personal injury/property damage claims
- cases currently in litigation
- vehicles not used primarily for family, personal or household purposes (except in states where the Dispute Settlement Board is required to review commercial vehicles)
- vehicles with non-U.S. warranties

Concerns are ineligible for review if the New Vehicle Limited Warranty has expired at receipt of your application and, in certain states eligibility is dependent upon the customer's possession of the vehicle.

Eligibility may differ according to state law. For example, see the unique brochures for California, West Virginia, Georgia and Wisconsin purchasers/lessees.

Customer Assistance

Board membership

The Board consists of:

- Three consumer representatives
- A Ford or Lincoln Mercury dealership representative

Consumer candidates for Board membership are recruited and trained by an independent consulting firm. The dealership Board member is chosen from Ford and Lincoln Mercury dealership management, recognized for their business leadership qualities.

What the Board needs

To have your case reviewed you must complete the application in the DSB brochure and mail it to the address provided on the application form. Some states will require you to use certified mail, with return receipt requested.

Your application is reviewed and, if it is determined to be eligible, you will receive an acknowledgment indicating:

- The file number assigned to your application.
- The toll-free phone number of the DSB's independent administrator.

Your dealership and a Ford Motor Company representative will then be asked to submit statements.

To properly review your case, the Board needs the following information:

- Legible copies of all documents and maintenance or repair orders relevant to the case.
- The year, make, model, and Vehicle Identification Number (VIN) listed on your vehicle ownership license.
- The date of repair(s) and mileage at the time of occurrence(s).
- The current mileage.
- The name of the dealer(s) who sold or serviced the vehicle.
- A brief description of your unresolved concern.
- A brief summary of the action taken by the dealer(s) and Ford Motor Company.
- The names (if known) of all the people you contacted at the dealership(s).
- A description of the action you expect to resolve your concern.

You will receive a letter of explanation if your application does not qualify for Board review.

Customer Assistance

Oral presentations

If you would like to make an oral presentation, indicate YES to question 6 on the application. While it is your right to make an oral presentation before the Board, this is not a requirement and the Board will decide the case whether or not an oral presentation is made. An oral presentation may be requested by the Board as well.

Making a decision

Board members review all available information related to each complaint, including oral presentations, and arrive at a fair and impartial decision. Board review may be terminated at any time by either party.

Every effort is made to decide the case within 40 days of the date that all requested information is received by the Board. Since the Board generally meets once a month, it may take longer for the Board to consider some cases.

After a case is reviewed, the Board mails you a decision letter and a form on which to accept or reject the Board's decision. The decisions of the Board are binding on Ford (and, in some cases, on the dealer) but not on consumers who are free to pursue other remedies available to them under state or federal law.

To request a DSB Brochure/Application

For a brochure/application, speak to your dealer or write/call to the Board at the following address/phone number:

Dispute Settlement Board
P.O. Box 5120
Southfield, MI 48086-5120
1-800-428-3718

You may also contact the North American Customer Relationship Center at 1-800-392-3673 (Ford), TDD for the hearing impaired: 1-800-232-5952 or by writing to the Center at the following address:

Ford Motor Company
Customer Relationship Center
16800 Executive Plaza Drive
P.O. Box 6248
Dearborn, Michigan 48121

Customer Assistance

UTILIZING THE MEDIATION/ARBITRATION PROGRAM (CANADA ONLY)

In those cases where you continue to feel that the efforts by Ford and the dealer to resolve a factory-related vehicle service concern have been unsatisfactory, Ford of Canada participates in an impartial third party mediation/arbitration program administered by the Canadian Motor Vehicle Arbitration Plan (CAMVAP).

The CAMVAP program is a straight-forward and relatively speedy alternative to resolve a disagreement when all other efforts to produce a settlement have failed. This procedure is without cost to you and is designed to eliminate the need for lengthy and expensive legal proceedings.

In the CAMVAP program, impartial third-party arbitrators conduct hearings at mutually convenient times and places in an informal environment. These impartial arbitrators review the positions of the parties, make decisions and, when appropriate, render awards to resolve disputes. CAMVAP decisions are fast, fair, and final; the arbitrator's award is binding both to you and Ford of Canada.

CAMVAP services are available in all territories and provinces. For more information, without charge or obligation, call your CAMVAP Provincial Administrator directly at 1-800-207-0685.

GETTING ASSISTANCE OUTSIDE THE U.S. AND CANADA

Before exporting your vehicle to a foreign country, contact the appropriate foreign embassy or consulate. These officials can inform you of local vehicle registration regulations and where to find unleaded fuel.

If you cannot find unleaded fuel or can only get fuel with an anti-knock index lower than is recommended for your vehicle, contact a district or owner relations/customer relationship office.

The use of leaded fuel in your vehicle without proper conversion may damage the effectiveness of your emission control system and may cause engine knocking or serious engine damage. Ford Motor Company/Ford of Canada is not responsible for any damage caused by use of improper fuel.

In the United States, using leaded fuel may also result in difficulty importing your vehicle back into the U.S.

Customer Assistance

If your vehicle must be serviced while you are traveling or living in Central or South America, the Caribbean, or the Middle East, contact the nearest Ford dealership. If the dealership cannot help you, write or call:

FORD MOTOR COMPANY
WORLDWIDE DIRECT MARKET OPERATIONS
1555 Fairlane Drive
Fairlane Business Park #3
Allen Park, Michigan 48101
U.S.A.
Telephone: (313) 594-4857
FAX: (313) 390-0804

If you are in another foreign country, contact the nearest Ford dealership. If the dealership employees cannot help you, they can direct you to the nearest Ford affiliate office.

If you buy your vehicle in North America and then relocate outside of the U.S. or Canada, register your vehicle identification number (VIN) and new address with Ford Motor Company Worldwide Direct Market Operations.

ORDERING ADDITIONAL OWNER'S LITERATURE

To order the publications in this portfolio, contact Helm, Incorporated at:
HELM, INCORPORATED
P.O. Box 07150
Detroit, Michigan 48207

Or call:

For a free publication catalog, order toll free: 1-800-782-4356

Monday-Friday 8:00 a.m. - 6:00 p.m. EST

Helm, Incorporated can also be reached by their website:
www.helminc.com.

(Items in this catalog may be purchased by credit card, check or money order.)

Obtaining a French owner's guide

French Owner's Guides can be obtained from your dealer or by writing to Ford Motor Company of Canada, Limited, Service Publications, P.O. Box 1580, Station B, Mississauga, Ontario L4Y 4G3.

Customer Assistance

IN CALIFORNIA (U.S. ONLY)

California Civil Code Section 1793.2(d) requires that, if a manufacturer or its representative is unable to repair a motor vehicle to conform to the vehicle's applicable express warranty after a reasonable number of attempts, the manufacturer shall be required to either replace the vehicle with one substantially identical or repurchase the vehicle and reimburse the buyer in an amount equal to the actual price paid or payable by the consumer (less a reasonable allowance for consumer use). The consumer has the right to choose whether to receive a refund or replacement vehicle.

California Civil Code Section 1793.22(b) presumes that the manufacturer has had a reasonable number of attempts to conform the vehicle to its applicable express warranties if, within the first 18 months of ownership of a new vehicle or the first 29,000 km (18,000 miles), whichever occurs first:

1. Two or more repair attempts are made on the same nonconformity likely to cause death or serious bodily injury OR
2. Four or more repair attempts are made on the same nonconformity (a defect or condition that substantially impairs the use, value or safety of the vehicle) OR
3. The vehicle is out of service for repair of nonconformities for a total of more than 30 calendar days (not necessarily all at one time)

In the case of 1 or 2 above, the consumer must also notify the manufacturer of the need for the repair of the nonconformity at the following address:

Ford Motor Company
16800 Executive Plaza Drive
Mail Drop 3NE-B
Dearborn, MI 48126

Customer Assistance

REPORTING SAFETY DEFECTS (U.S. ONLY)

If you believe that your vehicle has a defect which could cause a crash or could cause injury or death, you should immediately inform the National Highway Traffic Safety Administration (NHTSA) in addition to notifying Ford Motor Company.

Ford Motor Company

If NHTSA receives similar complaints, it may open an investigation, and if it finds that a safety defect exists in a group of vehicles, it may order a recall and remedy campaign. However, NHTSA cannot become involved in individual problems between you, your dealer, or Ford Motor Company.

To contact NHTSA, you may either call the Auto Safety Hotline toll-free at 1-800-424-9393 (or 366-0123 in the Washington D.C. area) or write to:

NHTSA
U.S. Department of Transportation
Washington, D.C. 20590

You can also obtain other information about motor vehicle safety from the Hotline.

Cleaning

WASHING THE EXTERIOR

Wash your vehicle regularly with cool or lukewarm water and a neutral Ph shampoo, such as Motorcraft Detail Wash (ZC-3-A), which is available from your dealer.

- Never use strong household detergents or soap, such as dish washing or laundry liquid. These products can discolor and spot painted surfaces.
- Never wash a vehicle that is “hot to the touch” or during exposure to strong, direct sunlight.
- Always use a clean sponge or carwash mitt with plenty of water for best results.
- Dry the vehicle with a chamois or soft terry cloth towel in order to eliminate water spotting.
- It is especially important to wash the vehicle regularly during the winter months, as dirt and road salt are difficult to remove and cause damage to the vehicle.
- Immediately remove items such as gasoline, diesel fuel, bird droppings and insect deposits because they can cause damage to the vehicle’s paintwork and trim over time.
- Remove any exterior accessories, such as antennas, before entering a car wash.
- **Suntan lotions and insect repellents can damage any painted surface; if these substances come in contact with your vehicle, wash off as soon as possible.**

WAXING

Applying a polymer paint sealant to your vehicle every six months will assist in reducing minor scratches and paint damage.

- Wash the vehicle first.
- Do not use waxes that contain abrasives.
- Do not allow paint sealant to come in contact with any non-body (low-gloss black) colored trim, such as grained door handles, roof racks, bumpers, side moldings, mirror housings or the windshield cowl area. The paint sealant will “gray” or stain the parts over time.

PAINT CHIPS

Your dealer has touch-up paint and sprays to match your vehicle's color. Take your color code (printed on a sticker in the driver's door jam) to your dealer to ensure you get the correct color.

- Remove particles such as bird droppings, tree sap, insect deposits, tar spots, road salt and industrial fallout before repairing paint chips.
- Always read the instructions before using the products.

ALUMINUM WHEELS AND WHEEL COVERS

Aluminum wheels and wheel covers are coated with a clearcoat paint finish. In order to maintain their shine:

- Clean weekly with Motorcraft Wheel and Tire Cleaner (ZC-37-A), which is available from your dealer. Heavy dirt and brake dust accumulation may require agitation with a sponge. Rinse thoroughly with a strong stream of water.
- Never apply any cleaning chemical to hot or warm wheel rims or covers.
- Some automatic car washes may cause damage to the finish on your wheel rims or covers. Chemical-strength cleaners, or cleaning chemicals, in combination with brush agitation to remove brake dust and dirt, could wear away the clearcoat finish over time.
- Do not use hydrofluoric acid-based or high caustic-based wheel cleaners, steel wool, fuels or strong household detergent.
- To remove tar and grease, use Ford Extra Strength Tar and Road Oil Removal (B7A-19520-AA), available from your dealer.

ENGINE

Engines are more efficient when they are clean because grease and dirt buildup keep the engine warmer than normal. When washing:

- Take care when using a power washer to clean the engine. The high-pressure fluid could penetrate the sealed parts and cause damage.
- Do not spray a hot engine with cold water to avoid cracking the engine block or other engine components.
- Spray Motorcraft Engine Shampoo and Degreaser (ZC-20) on all parts that require cleaning and pressure rinse clean.

Cleaning

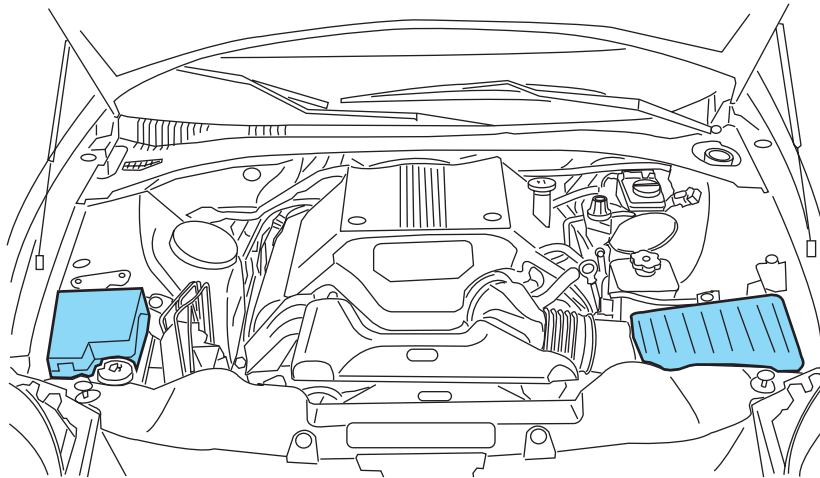

- Cover the highlighted areas to prevent water damage when cleaning the engine.
- Never wash or rinse the engine while it is running; water in the running engine may cause internal damage.

PLASTIC (NON-PAINTED) EXTERIOR PARTS

Use only approved products to clean plastic parts. These products are available from your dealer.

- For routine cleaning, use Motorcraft Detail Wash (ZC-3-A).
- If tar or grease spots are present, use Ford Extra Strength Tar and Road Oil Removal (B7A-19520-AA).

WINDOWS AND WIPER BLADES

The windshield, rear window and wiper blades should be cleaned regularly. If the wiper does not wipe properly, substances on the windshield, rear window or the wiper blades may be the cause. These may include hot wax treatments used by commercial car washes, tree sap, or other organic contamination. To clean these items, please follow these tips:

- The windshield or rear window may be cleaned with a non-abrasive cleaner such as Motorcraft Ultra Clear Spray Glass Cleaner (ZC-23), available from your dealer.

Cleaning

- Do not use abrasives, as they may cause scratches.
- Do not use fuel, kerosene, or paint thinner to clean any parts.
- Wiper blades can be cleaned with isopropyl (rubbing) alcohol or windshield washer solution. Be sure to replace wiper blades when they appear worn or do not function properly.

INSTRUMENT PANEL AND CLUSTER LENS

Clean the instrument panel with a damp cloth, then dry with a dry cloth.

- Avoid cleaners or polish that increase the gloss of the upper portion of the instrument panel. The dull finish in this area helps protect the driver from undesirable windshield reflection.



Do not use chemical solvents or strong detergents when cleaning the steering wheel or instrument panel to avoid contamination of the air bag system.

- Be certain to wash or wipe your hands clean if you have been in contact with certain products such as insect repellent and suntan lotion in order to avoid possible damage to the painted surfaces.

CONVERTIBLE TOP AND PADDED MOLDING

Wash with Motorcraft Triple Clean (ZC-13), which is available from your dealer.

- Do not use stiff bristle brushes or abrasive materials or cleaners.
- Hot waxes applied by commercial car washes can affect the cleanability of vinyl material.
- Using high water pressure or wand-type car washes against the convertible top and windows may cause water leaks and possible seal damage.

CLEANING SEATS EQUIPPED WITH SIDE AIR BAGS

Remove dust and loose dirt with a vacuum cleaner. In order to remove stains and soil, clean with Extra Strength Upholstery Cleaner (E8AZ-19523-AA).

Never saturate the seat covers with any cleaning solution.



Do not use chemical solvents or strong detergents when cleaning the seat where the side air bag is mounted. Such products could contaminate the side air bag system and affect performance of the side air bag in a collision. The air bag may not function correctly and not provide injury reduction benefits.

Cleaning

INTERIOR

For fabric, carpets, cloth seats, safety belts and seats equipped with side air bags:

- Remove dust and loose dirt with a vacuum cleaner.
- Remove light stains and soil with Ford Extra Strength Upholstery Cleaner (E8AZ-19523-AA).
- If grease or tar is present on the material, spot-clean the area first with Motorcraft Spot and Stain Remover (ZC-14).
- Never saturate the seat covers with cleaning solution.
- Do not use household cleaning products or glass cleaners, which can stain and discolor the fabric and affect the flame retardant abilities of the seat materials.



Do not use cleaning solvents, bleach or dye on the vehicle's safety belts, as these actions may weaken the belt webbing.

LEATHER SEATS

Your leather seating surfaces have a clear, protective coating over the leather.

- To clean, use a soft cloth with Motorcraft Deluxe Leather and Vinyl Cleaner (ZC-11-A). Dry the area with a soft cloth.
- To help maintain its resiliency and color, use the Motorcraft Deluxe Leather Care Kit (ZC-11-D), available from your authorized dealer.
- Do not use household cleaning products, alcohol solutions, solvents or cleaners intended for rubber, vinyl and plastics, or oil/petroleum-based leather conditioners. These products may cause premature wearing of the clear, protective coating.

UNDERBODY

Flush the complete underside of your vehicle frequently. Keep body and door drain holes free from packed dirt.

FORD, LINCOLN AND MERCURY CAR CARE PRODUCTS

Your Ford, Lincoln or Mercury dealer has many quality products available to clean your vehicle and protect its finishes. These quality products have been specifically engineered to fulfill your automotive needs; they are custom designed to complement the style and appearance of your vehicle. Each product is made from high quality materials that meet or exceed rigid specifications. For best results, use the following products or products of equivalent quality:

Motorcraft Custom Clearcoat Polish (ZC-8-A)

Ford Custom Vinyl Protectant* (not available in Canada)
(F2AZ-19530-A)

Motorcraft Vinyl Cleaner (Canada only) (CXC-93)

Motorcraft Vinyl Conditioner (Canada only) (CXC-94)

Motorcraft Deluxe Leather and Vinyl Cleaner (not available in Canada)
(ZC-11-A)

Ford Extra Strength Tar and Road Oil Remover* (not available in Canada)
(B7A-19520-AA)

Ford Extra Strength Upholstery Cleaner (not available in Canada)
(E8AZ-19523-AA)

Motorcraft Custom Bright Metal Cleaner (ZC-15)

Motorcraft Wheel and Tire Cleaner (ZC-37-A)

Motorcraft Dash and Vinyl Cleaner (ZC-38-A)

Motorcraft Car Care Kit (ZC-26)

Ford Premium Car Wash Concentrate (F2SZ-19523-WC)

Motorcraft Carlite Glass Cleaner (Canada only) (CXC-100)

Motorcraft Spot and Stain Remover (ZC-14)

Motorcraft Detail Wash (ZC-3-A)

Motorcraft Tire Detailer (ZC-28)

Motorcraft Triple Clean (ZC-13)

Motorcraft Ultra-Clear Spray Glass Cleaner (not available in Canada)
(ZC-23)

Motorcraft Engine Shampoo and Degreaser (ZC-20)

* May be sold with the Motorcraft name

Maintenance and Specifications

SERVICE RECOMMENDATIONS

To help you service your vehicle:

- We highlight do-it-yourself items in the engine compartment for easy location.
- We provide a scheduled maintenance guide which makes tracking routine service easy.

If your vehicle requires professional service, your dealership can provide the necessary parts and service. Check your *Warranty Guide/Owner Information Guide* to find out which parts and services are covered.

Use only recommended fuels, lubricants, fluids and service parts conforming to specifications. Motorcraft parts are designed and built to provide the best performance in your vehicle.

PRECAUTIONS WHEN SERVICING YOUR VEHICLE

Be especially careful when inspecting or servicing your vehicle.

- Do not work on a hot engine.
- When the engine is running, keep loose clothing, jewelry or long hair away from moving parts.
- Do not work on a vehicle with the engine running in an enclosed space, unless you are sure you have enough ventilation.
- Keep all lit cigarettes, open flames and other lit material away from the battery and all fuel related parts.

If you disconnect the battery, the engine must “relearn” its idle conditions before your vehicle will drive properly, as explained in the *Battery* section in this chapter.

Working with the engine off

1. Set the parking brake and ensure the gearshift is securely latched in P (Park).
2. Turn off the engine and remove the key.
3. Block the wheels to prevent the vehicle from moving unexpectedly.

Maintenance and Specifications

Working with the engine on

1. Set the parking brake and ensure the gearshift is securely latched in P (Park).
2. Block the wheels to prevent the vehicle from moving unexpectedly.

Note: Do not start your engine with the air cleaner removed and do not remove it while the engine is running.

OPENING THE HOOD

1. Inside the vehicle, pull the hood release handle located at the bottom left of the instrument panel.
2. Go to the front of the vehicle and release the auxiliary latch that is located under the front center of the hood by pushing the handle toward the passenger side of the vehicle.
3. Lift the hood until the lift cylinders hold it open.

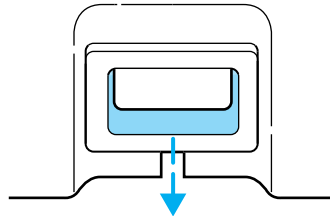

Maintenance and Specifications

IDENTIFYING COMPONENTS IN THE ENGINE COMPARTMENT

3.9L-4V V8 engine

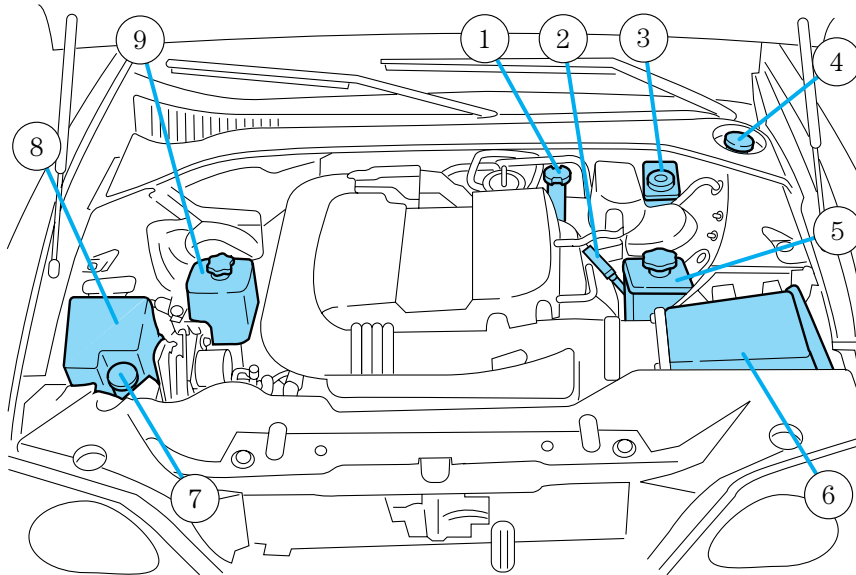

1. Engine oil filler cap
2. Engine oil dipstick
3. Brake fluid reservoir
4. Engine coolant reservoir
5. Power steering fluid reservoir
6. Air filter assembly
7. Windshield washer fluid reservoir
8. Power distribution box

Maintenance and Specifications

Check the washer fluid whenever you stop for fuel. The reservoir is highlighted with a  symbol.

Add fluid to fill the reservoir if the level is low. In very cold weather, do not fill the reservoir completely.

Only use a washer fluid that meets Ford specification ESR-M17P5-A . Refer to *Lubricant specifications* in this chapter.



State or local regulations on volatile organic compounds may restrict the use of methanol, a common windshield washer antifreeze additive. Washer fluids containing non-methanol antifreeze agents should be used only if they provide cold weather protection without damaging the vehicle's paint finish, wiper blades or washer system.

 If you operate your vehicle in temperatures below 4.5° C (40° F), use washer fluid with antifreeze protection. Failure to use washer fluid with antifreeze protection in cold weather could result in impaired windshield vision and increase the risk of injury or accident.

Note: Do not put washer fluid in the engine coolant reservoir. Washer fluid placed in the cooling system may harm engine and cooling system components.

ENGINE OIL

Checking the engine oil

Refer to the scheduled maintenance guide for the appropriate intervals for checking the engine oil.

1. Make sure the vehicle is on level ground.
2. Turn the engine off and wait a few minutes for the oil to drain into the oil pan.
3. Set the parking brake and ensure the gearshift is securely latched in P (Park).
4. Open the hood. Protect yourself from engine heat.

Maintenance and Specifications

5. Locate and carefully remove the engine oil level indicator (dipstick).

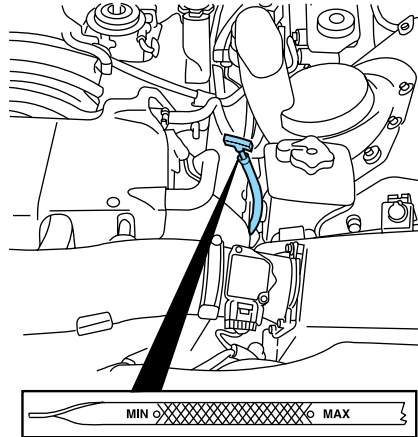

6. Wipe the indicator clean. Insert the indicator fully, then remove it again.

- If the oil level is **between the MIN and MAX marks**, the oil level is acceptable. **DO NOT ADD OIL.**
- If the oil level is below the MIN mark, add enough oil to raise the level within the MIN-MAX range.

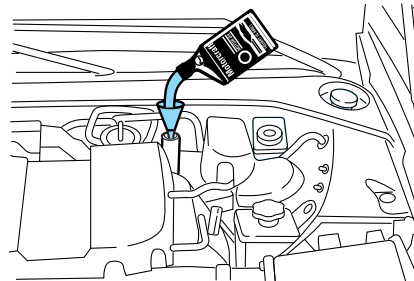

- Oil levels above the MAX mark may cause engine damage. Some oil must be removed from the engine by a service technician.

7. Put the indicator back in and ensure it is fully seated.

Adding engine oil

1. Check the engine oil. For instructions, refer to *Checking the engine oil* in this chapter.

Maintenance and Specifications

2. If the engine oil level is not within the normal range, add only certified engine oil of the recommended viscosity. Remove the engine oil filler cap and use a funnel to pour the engine oil into the opening.
3. Recheck the engine oil level. Make sure the oil level is not above the MAX mark on the engine oil level indicator (dipstick).
4. Install the indicator and ensure it is fully seated.
5. Fully install the engine oil filler cap by turning the filler cap clockwise tightly until clicks are heard, or until it is snug.

To avoid possible oil loss, DO NOT operate the vehicle with the engine oil level indicator and/or the engine oil filler cap removed.

Engine oil and filter recommendations

Look for this certification trademark.

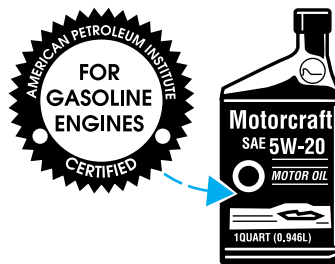

SAE 5W-20 engine oil is recommended.

Only use oils “Certified For Gasoline Engines” by the American Petroleum Institute (API). Use Motorcraft or an equivalent oil meeting Ford specification WSS-M2C153-H. **SAE 5W-20 oil provides optimum fuel economy and durability performance meeting all requirements for your vehicle’s engine.**

Do not use supplemental engine oil additives, oil treatments or engine treatments. They are unnecessary and could, under certain conditions, lead to engine damage which is not covered by your warranty.

Change your engine oil and filter according to the appropriate schedule listed in the scheduled maintenance guide.

Ford production and aftermarket (Motorcraft) oil filters are designed for added engine protection and long life. If a replacement oil filter is used that does not meet Ford material and design specifications, start-up engine noises or knock may be experienced.

It is recommended you use the appropriate Motorcraft oil filter (or another brand meeting Ford specifications) for your engine application.

Maintenance and Specifications

BATTERY

Your vehicle is equipped with a Motorcraft maintenance-free battery which is located in the luggage compartment, next to the spare tire.

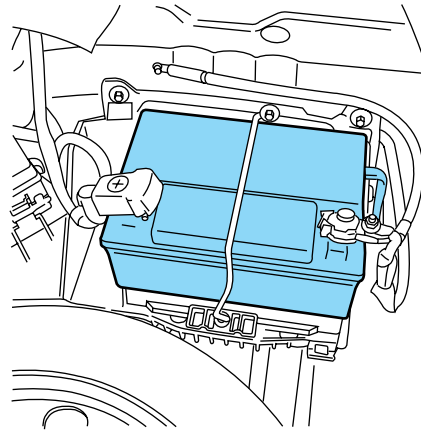

Your battery is designed to purge any battery gases to the outside of the vehicle by means of a vent hose. This vent hose **MUST** be attached at all times. Replacement batteries must be of the same vented design.

If your battery has a cover/shield, make sure it is reinstalled after the battery has been cleaned or replaced.

Your battery normally does not require additional water during its life of service. For longer, trouble-free operation, keep the top of the battery clean and dry. Make certain that the vent hose is attached. Also, make certain the battery cables are always tightly fastened to the battery terminals.

If you see any corrosion on the battery or terminals, remove the cables from the terminals and clean with a wire brush. You can neutralize the acid with a solution of baking soda and water.



Batteries normally produce explosive gases which can cause personal injury. Therefore, do not allow flames, sparks or lighted substances to come near the battery. When working near the battery, always shield your face and protect your eyes. Always provide proper ventilation.

Maintenance and Specifications



When lifting a plastic-cased battery, excessive pressure on the end walls could cause acid to flow through the vent caps, resulting in personal injury and/or damage to the vehicle or battery. Lift the battery with a battery carrier or with your hands on opposite corners.



Keep batteries out of reach of children. Batteries contain sulfuric acid. Avoid contact with skin, eyes or clothing. Shield your eyes when working near the battery to protect against possible splashing of acid solution. In case of acid contact with skin or eyes, flush immediately with water for a minimum of 15 minutes and get prompt medical attention. If acid is swallowed, call a physician immediately.



Battery posts, terminals and related accessories contain lead and lead compounds. **Wash hands after handling.**

Because your vehicle's engine is electronically controlled by a computer, some control conditions are maintained by power from the battery. When the battery is disconnected or a new battery is installed, the engine must relearn its idle and fuel trim strategy for optimum driveability and performance. To begin this process:

1. With the vehicle at a complete stop, set the parking brake.
 2. Put the gearshift in P (Park), turn off all accessories and start the engine.
 3. Run the engine until it reaches normal operating temperature.
 4. Allow the engine to idle for at least one minute.
 5. Turn the A/C on and allow the engine to idle for at least one minute.
 6. Drive the vehicle to complete the relearning process.
- The vehicle may need to be driven to relearn the idle and fuel trim strategy.
 - **If you do not allow the engine to relearn its idle trim, the idle quality of your vehicle may be adversely affected until the idle trim is eventually relearned.**

When the battery is disconnected or a new battery installed, the transmission must relearn its adaptive strategy. As a result of this, the transmission may shift firmly. This operation is considered normal and will not affect function or durability of the transmission. Over time the adaptive learning process will fully update transmission operation to its optimum shift feel.

Maintenance and Specifications

If the battery has been disconnected or a new battery has been installed, the short drop glass, clock and the preset radio stations must be reset once the battery is reconnected.

- Always dispose of automotive batteries in a responsible manner. Follow your local authorized standards for disposal. Call your local authorized recycling center to find out more about recycling automotive batteries.

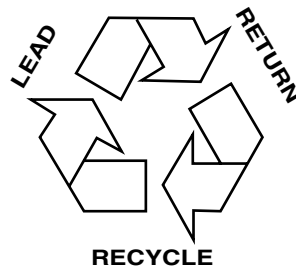

ENGINE COOLANT

Checking engine coolant

The concentration and level of engine coolant should be checked at the mileage intervals listed in the scheduled maintenance guide. The coolant concentration should be maintained at 50/50 coolant and distilled water, which equates to a freeze point of -36°C (-34°F). Coolant concentration testing is possible with a hydrometer or antifreeze tester (such as the Rotunda Battery and Antifreeze Tester, 014-R1060). The level of coolant should be maintained at the “cold full” or “cold fill range” level in the coolant reservoir. If the level falls below, add coolant per the instructions in the *Adding engine coolant* section.

Your vehicle was factory-filled with a 50/50 engine coolant and water concentration. If the concentration of coolant falls below 40% or above 60%, the engine parts could become damaged or not work properly. **A 50–50 mixture of coolant and water provides the following:**

- **Freeze protection down to -36°C (-34°F).**
- **Boiling protection up to 129°C (265°F).**
- **Protection against rust and other forms of corrosion.**
- **Enables calibrated gauges to work properly.**

Maintenance and Specifications

When the engine is cold, check the level of the engine coolant in the reservoir.



- The engine coolant should be at the “cold fill level” or within the “cold fill range” as listed on the engine coolant reservoir (depending upon application).
- Refer to the Scheduled Maintenance Guide for service interval schedules.
- Be sure to read and understand *Precautions when servicing your vehicle* in this chapter.

If the engine coolant has not been checked at the recommended interval, the engine coolant reservoir may become low or empty. If the reservoir is low or empty, add engine coolant to the reservoir. Refer to *Adding engine coolant* in this chapter.

Note: Automotive fluids are not interchangeable; do not use engine coolant, antifreeze or windshield washer fluid outside of its specified function and vehicle location.

Adding engine coolant

When adding coolant, make sure it is a 50/50 mixture of engine coolant and distilled water. Add the mixture to the coolant reservoir, **when the engine is cool**, until the appropriate fill level is obtained.

Maintenance and Specifications



Do not add engine coolant when the engine is hot. Steam and scalding liquids released from a hot cooling system can burn you badly. Also, you can be burned if you spill coolant on hot engine parts.



Do not put engine coolant in the windshield washer fluid container. If sprayed on the windshield, engine coolant could make it difficult to see through the windshield.

The cooling system in your vehicle is filled with either green-colored Motorcraft Premium Engine Coolant meeting Ford specification ESE-M97B44-A or yellow-colored Motorcraft Premium Gold Engine Coolant meeting Ford Specification WSS-M97B51-A1. To determine your vehicle's coolant type (color), check your coolant reservoir.

- **Add Motorcraft Premium Engine Coolant (green-colored), VC-4-A (U.S.) or CXC-10 (Canada) or Motorcraft Premium Gold Engine Coolant (yellow-colored), VC-7-A (VC-7-B in Oregon), depending on the type of coolant originally equipped in your vehicle.** If you are unsure which type of coolant your vehicle requires, check your coolant reservoir or contact your local dealer.

Note: Use of Motorcraft Cooling System Stop Leak Pellets, VC-6, darkens the color of Motorcraft Premium Gold Engine Coolant from yellow to golden tan.

- **Do not add/mix an orange-colored, extended life coolant such as Motorcraft Speciality Orange Engine Coolant, VC-2 (US) or CXC-209 (Canada), meeting Ford specification WSS-M97B44-D with the factory-filled coolant.** Mixing Motorcraft Speciality Orange Engine Coolant or any orange-colored extended life product with your factory filled coolant can result in degraded corrosion protection.
- A large amount of water without engine coolant may be added, in case of emergency, to reach a vehicle service location. In this instance, the cooling system must be drained and refilled with a 50/50 mixture of engine coolant and distilled water as soon as possible. Water alone (without engine coolant) can cause engine damage from corrosion, overheating or freezing.
- **Do not use alcohol, methanol, brine or any engine coolants mixed with alcohol or methanol antifreeze (coolant).** Alcohol and other liquids can cause engine damage from overheating or freezing.

Maintenance and Specifications

- **Do not add extra inhibitors or additives to the coolant.** These can be harmful and compromise the corrosion protection of the engine coolant.
- **Do not mix with recycled coolant unless from a Ford-approved recycling process (see *Use of Recycled engine coolant* section).**

For vehicles with overflow coolant systems with a non-pressurized cap on the coolant recovery system, add coolant to the coolant recovery reservoir when the engine is cool. Add the proper mixture of coolant and water to the “cold full” level. For all other vehicles, which have a coolant degas system with a pressurized cap, or if it is necessary to remove the coolant pressure relief cap on the radiator of a vehicle with an overflow system, follow these steps to add engine coolant.



To reduce the risk of personal injury, make sure the engine is cool before unscrewing the coolant pressure relief cap. The cooling system is under pressure; steam and hot liquid can come out forcefully when the cap is loosened slightly.

1. Before you begin, turn the engine off and let it cool.
2. When the engine is cool, wrap a thick cloth around the coolant pressure relief cap on the coolant reservoir (an opaque plastic bottle). Slowly turn cap counterclockwise (left) until pressure begins to release.
3. Step back while the pressure releases.
4. When you are sure that all the pressure has been released, use the cloth to turn it counterclockwise and remove the cap.
5. Fill the coolant reservoir slowly with the proper coolant mixture (see above), to within the “cold fill range” or the “cold full” level on the reservoir. If you removed the radiator cap in an overflow system, fill the radiator until the coolant is visible and radiator is almost full.
6. Replace the cap. Turn until tightly installed. (Cap must be tightly installed to prevent coolant loss.)

After any coolant has been added, check the coolant concentration, refer to *Checking Engine Coolant* section. If the concentration is not 50/50 (protection to $-34^{\circ}\text{F}/-36^{\circ}\text{C}$), drain some coolant and adjust the concentration. It may take several drains and additions to obtain a 50/50 coolant concentration.

Whenever coolant has been added, the coolant level in the coolant reservoir should be checked the next few times you drive the vehicle. If necessary, add enough 50/50 concentration of engine coolant and distilled water to bring the liquid level to the proper level.

Maintenance and Specifications

If you have to add more than 1.0 liter (1.0 quart) of engine coolant per month, have your dealer check the engine cooling system. Your cooling system may have a leak. Operating an engine with a low level of coolant can result in engine overheating and possible engine damage.

Recycled engine coolant

Ford Motor Company recommends the use of a recycled engine coolant produced by Ford-approved processes in vehicles originally equipped with Motorcraft Premium Engine Coolant (green-colored). However, not all coolant recycling processes produce coolant that meets Ford specification ESE-M97B44-A. Use of such coolant may harm the engine and cooling system components.

Ford Motor Company does NOT recommend the use of recycled engine coolant in vehicles originally equipped with Motorcraft Premium Gold Engine Coolant since a Ford-approved recycling process is not yet available.



Used engine coolant should be disposed of in an appropriate manner. Follow your community's regulations and standards for recycling and disposing of automotive fluids.

Coolant refill capacity

To find out how much fluid your vehicle's cooling system can hold, refer to *Refill capacities* in this chapter.

Fill your engine coolant reservoir as outlined in *Adding engine coolant* in this chapter.

Severe climates

If you drive in extremely cold climates (less than -36°C [-34°F]), it may be necessary to increase the coolant concentration above 50%.

Refer to the chart on the coolant container to ensure the coolant concentration in your vehicle will provide adequate freeze protection.

Never increase the engine coolant concentration above 60% (protection to -60°F). At a level over 60%, your engine could overheat and become damaged.

If you drive in extremely hot climates, it is still necessary to maintain the coolant concentration at 50/50 coolant and water. **Do not allow the coolant concentration to fall below 40% coolant.** At a concentration less than 40%, the corrosion protection to your engine and cooling components may be compromised and permanent damage may result.



Maintenance and Specifications

What you should know about fail-safe cooling

If the engine coolant supply is depleted, this feature allows the vehicle to be driven temporarily before incremental component damage is incurred. The “fail-safe” distance depends on ambient temperatures, vehicle load and terrain.

How fail-safe cooling works

If the engine begins to overheat:

- The engine coolant temperature gauge will move to the H (hot) area.
- The  symbol will illuminate.
- The  symbol will illuminate.
- The  symbol will illuminate.



If the engine reaches a preset over-temperature condition, the engine will automatically switch to alternating cylinder operation. Each disabled cylinder acts as an air pump and cools the engine.

When this occurs the vehicle will still operate. However:

- The engine power will be limited.
- The air conditioning system will be disabled.

Continued operation will increase the engine temperature and the engine will completely shut down, causing steering and braking effort to increase.

Once the engine temperature cools, the engine can be re-started. Take your vehicle to a service facility as soon as possible to minimize engine damage.

When fail-safe mode is activated

You have limited engine power when in the fail-safe mode, so drive the vehicle with caution. The vehicle will not be able to maintain high-speed operation and the engine will run rough. Remember that the engine is capable of completely shutting down automatically to prevent engine damage, therefore:

1. Pull off the road as soon as safely possible and turn off the engine.
2. Arrange for the vehicle to be taken to a service facility.
3. If this is not possible, wait a short period for the engine to cool.

Maintenance and Specifications

4. Check the coolant level and replenish if low.



Never remove the coolant reservoir cap while the engine is running or hot.

5. Re-start the engine and take your vehicle to a service facility.

Driving the vehicle without repairing the engine problem increases the chance of engine damage. Take your vehicle to a service facility as soon as possible.

Checking and adding engine cooling fan hydraulic fluid

Check the engine cooling fan hydraulic fluid. Refer to the scheduled maintenance guide for the service interval schedules. If adding fluid is necessary, use only MERCON® ATF.

Check the fluid level when it is at ambient temperature (-7° to 25° C [20° to 80° F]):

1. Check the fluid level in the reservoir. It should be between the MIN and MAX lines. Do not add fluid if the level is in this range.
2. If the fluid is low, add fluid in small amounts, continuously checking the level until it reaches the range between the MIN and MAX lines. Be sure to put the cap back on the reservoir.

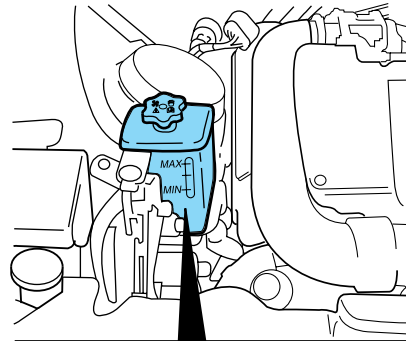

Maintenance and Specifications

WHAT YOU SHOULD KNOW ABOUT AUTOMOTIVE FUELS

Important safety precautions



Do not overfill the fuel tank. The pressure in an overfilled tank may cause leakage and lead to fuel spray and fire.



The fuel system may be under pressure. If the fuel filler cap is venting vapor or if you hear a hissing sound, wait until it stops before completely removing the fuel filler cap. Otherwise, fuel may spray out and injure you or others.



If you do not use the proper fuel filler cap, excessive pressure or vacuum in the fuel tank may damage the fuel system or cause the fuel cap to disengage in a collision, which may result in possible personal injury.



Automotive fuels can cause serious injury or death if misused or mishandled.



Gasoline may contain benzene, which is a cancer-causing agent.

Observe the following guidelines when handling automotive fuel:

- Extinguish all smoking materials and any open flames before fueling your vehicle.
- Always turn off the vehicle before fueling.
- Automotive fuels can be harmful or fatal if swallowed. Fuel such as gasoline is highly toxic and if swallowed can cause death or permanent injury. If fuel is swallowed, call a physician immediately, even if no symptoms are immediately apparent. The toxic effects of fuel may not be visible for hours.
- Avoid inhaling fuel vapors. Inhaling too much fuel vapor of any kind can lead to eye and respiratory tract irritation. In severe cases, excessive or prolonged breathing of fuel vapor can cause serious illness and permanent injury.



Maintenance and Specifications

- Avoid getting fuel liquid in your eyes. If fuel is splashed in the eyes, remove contact lenses (if worn), flush with water for 15 minutes and seek medical attention. Failure to seek proper medical attention could lead to permanent injury.
- Fuels can also be harmful if absorbed through the skin. If fuel is splashed on the skin and/or clothing, promptly remove contaminated clothing and wash skin thoroughly with soap and water. Repeated or prolonged skin contact with fuel liquid or vapor causes skin irritation.
- Be particularly careful if you are taking “Antabuse” or other forms of disulfiram for the treatment of alcoholism. Breathing gasoline vapors, or skin contact could cause an adverse reaction. In sensitive individuals, serious personal injury or sickness may result. If fuel is splashed on the skin, promptly wash skin thoroughly with soap and water. Consult a physician immediately if you experience an adverse reaction.



When refueling always shut the engine off and never allow sparks or open flames near the filler neck. Never smoke while refueling. Fuel vapor is extremely hazardous under certain conditions. Care should be taken to avoid inhaling excess fumes.



The flow of fuel through a fuel pump nozzle can produce static electricity, which can cause a fire if fuel is pumped into an ungrounded fuel container.

Use the following guidelines to avoid static build-up when filling an ungrounded fuel container:

- Place approved fuel container on the ground.
- DO NOT fill a fuel container while it is in the vehicle (including the cargo area).
- Keep the fuel pump nozzle in contact with the fuel container while filling.
- DO NOT use a device that would hold the fuel pump handle in the fill position.

Maintenance and Specifications

Fuel Filler Cap

Your fuel tank filler cap has an indexed design with a 1/8 turn on/off feature.

When fueling your vehicle:

1. Turn the engine off.
2. Carefully turn the filler cap counterclockwise 1/8 of a turn until it stops.
3. Pull to remove the cap from the fuel filler pipe.
4. To install the cap, align the tabs on the cap with the notches on the filler pipe.
5. Turn the filler cap clockwise 1/8 of a turn until it stops.

If the “Check Fuel Cap” indicator comes on and stays on after you start the engine, the fuel filler cap may not be properly installed. Turn off the engine, remove the fuel filler cap, align the cap properly and reinstall it.

If you must replace the fuel filler cap, replace it with a fuel filler cap that is designed for your vehicle. The customer warranty may be void for any damage to the fuel tank or fuel system if the correct genuine Ford or Motorcraft fuel filler cap is not used.



The fuel system may be under pressure. If the fuel filler cap is venting vapor or if you hear a hissing sound, wait until it stops before completely removing the fuel filler cap. Otherwise, fuel may spray out and injure you or others.



If you do not use the proper fuel filler cap, excessive pressure or vacuum in the fuel tank may damage the fuel system or cause the fuel cap to disengage in a collision, which may result in possible personal injury.

Choosing the right fuel

Use only UNLEADED FUEL. The use of leaded fuel is prohibited by law and could damage your vehicle.

Do not use fuel containing methanol. It can damage critical fuel system components.

Your vehicle was not designed to use fuel or fuel additives with metallic compounds, including manganese-based compounds containing MMT.

Repairs to correct the effects of using a fuel for which your vehicle was not designed may not be covered by your warranty.

Maintenance and Specifications

Octane recommendations

Your vehicle is designed to use “Premium” unleaded gasoline with an (R+M)/2 octane rating of 91 or higher for optimum performance.

The use of gasolines with lower octane ratings may degrade performance. We do not recommend the use of gasolines labeled as “Premium” in high altitude areas that are sold with octane ratings of less than 91.

Do not be concerned if your engine sometimes knocks lightly. However, if it knocks heavily under most driving conditions while you are using fuel with the recommended octane rating, see your dealer or a qualified service technician to prevent any engine damage.

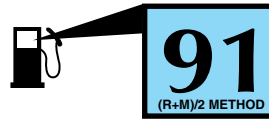

Fuel quality

If you are experiencing starting, rough idle or hesitation driveability problems during a cold start, try a different brand of “Premium” unleaded gasoline. If the problems persist, see your dealer or a qualified service technician.

It should not be necessary to add any aftermarket products to your fuel tank if you continue to use high quality fuel of the recommended octane rating. Aftermarket products could cause damage to the fuel system. Repairs to correct the effects of using an aftermarket product in your fuel may not be covered by your warranty.

Many of the world’s automakers issued the World-wide Fuel Charter that recommends gasoline specifications to provide improved performance and emission control system protection for your vehicle. Gasolines that meet the World-wide Fuel Charter should be used when available. Ask your fuel supplier about gasolines that meet the World-wide Fuel Charter. In Canada, look for fuels that display the **Auto Makers’ Choice**[™] logo.

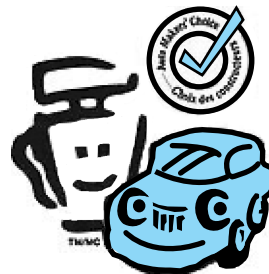

Cleaner air

Ford endorses the use of reformulated “cleaner-burning” gasolines to improve air quality.

Maintenance and Specifications

Running out of fuel

Avoid running out of fuel because this situation may have an adverse affect on powertrain components.

If you have run out of fuel:

- You may need to cycle the ignition from OFF to ON several times after refueling, to allow the fuel system to pump the fuel from the tank to the engine.
- Your “Check Engine” indicator may come on. For more information on the “Check Engine” indicator, refer to the *Instrument Cluster* chapter.

Fuel Filter

For fuel filter replacement, see your dealer or a qualified service technician. Refer to the scheduled maintenance guide for the appropriate intervals for changing the fuel filter.

Replace the fuel filter with an authorized Motorcraft part. The customer warranty may be void for any damage to the fuel system if an authorized Motorcraft fuel filter is not used.

ESSENTIALS OF GOOD FUEL ECONOMY

Measuring techniques

Your best source of information about actual fuel economy is you, the driver. You must gather information as accurately and consistently as possible. Fuel expense, frequency of fill-ups or fuel gauge readings are NOT accurate as a measure of fuel economy. We do not recommend taking fuel economy measurements during the first 1,600 km (1,000 miles) of driving (engine break-in period). You will get a more accurate measurement after 3,000 km–5,000 km (2,000 miles–3,000 miles).

Filling the tank

The advertised fuel capacity of the fuel tank on your vehicle is equal to the rated refill capacity of the fuel tank as listed in the *Refill capacities* section of this chapter.

The advertised capacity is the amount of the indicated capacity and the empty reserve combined. Indicated capacity is the difference in the amount of fuel in a full tank and a tank when the fuel gauge indicates empty. Empty reserve is the small amount of fuel remaining in the fuel tank after the fuel gauge indicates empty.

Maintenance and Specifications

The amount of usable fuel in the empty reserve varies and should not be relied upon to increase driving range. When refueling your vehicle after the fuel gauge indicates empty, you might not be able to refuel the full amount of the advertised capacity of the fuel tank due to the empty reserve still present in the tank.

For consistent results when filling the fuel tank:

- Turn the engine/ignition switch to the off position prior to refueling, an error in the reading will result if the engine is left running.
- Use the same filling rate setting (low — medium — high) each time the tank is filled.
- Allow no more than 2 automatic click-offs when filling.
- Always use fuel with the recommended octane rating.
- Use a known quality gasoline, preferably a national brand.
- Use the same side of the same pump and have the vehicle facing the same direction each time you fill up.
- Have the vehicle loading and distribution the same every time.

Your results will be most accurate if your filling method is consistent.

Calculating fuel economy

1. Fill the fuel tank completely and record the initial odometer reading (in kilometers or miles).
2. Each time you fill the tank, record the amount of fuel added (in liters or gallons).
3. After at least three to five tank fill-ups, fill the fuel tank and record the current odometer reading.
4. Subtract your initial odometer reading from the current odometer reading.
5. Follow one of the simple calculations in order to determine fuel economy:

Calculation 1: **Multiply liters used by 100, then divide by total kilometers traveled.**

Calculation 2: **Divide total miles traveled by total gallons used.**

Keep a record for at least one month and record the type of driving (city or highway). This will provide an accurate estimate of the vehicle's fuel economy under current driving conditions. Additionally, keeping records during summer and winter will show how temperature impacts fuel economy. In general, lower temperatures give lower fuel economy.

Maintenance and Specifications

Driving style — good driving and fuel economy habits

Give consideration to the lists that follow and you may be able to change a number of variables and improve your fuel economy.

Habits

- Smooth, moderate operation can yield up to 10% savings in fuel.
- Steady speeds without stopping will usually give the best fuel economy.
- Idling for long periods of time (greater than one minute) may waste fuel.
- Anticipate stopping; slowing down may eliminate the need to stop.
- Sudden or hard accelerations may reduce fuel economy.
- Slow down gradually.
- Driving at reasonable speeds (traveling at 88 km/h [55 mph] uses 15% less fuel than traveling at 105 km/h [65 mph]).
- Revving the engine before turning it off may reduce fuel economy.
- Using the air conditioner or defroster may reduce fuel economy.
- You may want to turn off the speed control in hilly terrain if unnecessary shifting between fourth and fifth gear occurs. Unnecessary shifting of this type could result in reduced fuel economy.
- Warming up a vehicle on cold mornings is not required and may reduce fuel economy.
- Resting your foot on the brake pedal while driving may reduce fuel economy.
- Combine errands and minimize stop-and-go driving.

Maintenance

- Keep tires properly inflated and use only recommended size.
- Operating a vehicle with the wheels out of alignment will reduce fuel economy.
- Use recommended engine oil. Refer to *Lubricant specifications* in this chapter.
- Perform all regularly scheduled maintenance items. Follow the recommended maintenance schedule and owner maintenance checks found in your vehicle scheduled maintenance guide.

Maintenance and Specifications

Conditions

- Heavily loading a vehicle or towing a trailer may reduce fuel economy at any speed.
- Carrying unnecessary weight may reduce fuel economy (approximately 0.4 km/L [1 mpg] is lost for every 180 kg [400 lb] of weight carried).
- Adding certain accessories to your vehicle (for example bug deflectors, rollbars/light bars, running boards, ski/luggage racks) may reduce fuel economy.
- Using fuel blended with alcohol may lower fuel economy.
- Fuel economy may decrease with lower temperatures during the first 12–16 km (8–10 miles) of driving.
- Driving on flat terrain offers improved fuel economy as compared to driving on hilly terrain.
- Transmissions give their best fuel economy when operated in the top cruise gear and with steady pressure on the gas pedal.
- Four-wheel-drive operation (if equipped) is less fuel efficient than two-wheel-drive operation.
- Close windows for high speed driving.

EPA window sticker

Every new vehicle should have the EPA window sticker. Contact your dealer if the window sticker is not supplied with your vehicle. The EPA window sticker should be your guide for the fuel economy comparisons with other vehicles.

It is important to note the box in the lower left corner of the window sticker. These numbers represent the Range of L/100 km (MPG) expected on the vehicle under optimum conditions. Your fuel economy may vary depending upon the method of operation and conditions.

EMISSION CONTROL SYSTEM

Your vehicle is equipped with various emission control components and a catalytic converter which will enable your vehicle to comply with applicable exhaust emission standards. To make sure that the catalytic converter and other emission control components continue to work properly:

- Use only the specified fuel listed.
- Avoid running out of fuel.

Maintenance and Specifications

- Do not turn off the ignition while your vehicle is moving, especially at high speeds.
- Have the items listed in your scheduled maintenance guide performed according to the specified schedule.

The scheduled maintenance items listed in the scheduled maintenance guide are essential to the life and performance of your vehicle and to its emissions system.

If other than Ford, Motorcraft or Ford-authorized parts are used for maintenance replacements or for service of components affecting emission control, such non-Ford parts should be equivalent to genuine Ford Motor Company parts in performance and durability.



Do not park, idle, or drive your vehicle in dry grass or other dry ground cover. The emission system heats up the engine compartment and exhaust system, which can start a fire.

Illumination of the “Check Engine” light, charging system warning light or the temperature warning light, fluid leaks, strange odors, smoke or loss of engine power, could indicate that the emission control system is not working properly.



Exhaust leaks may result in entry of harmful and potentially lethal fumes into the passenger compartment.

Do not make any unauthorized changes to your vehicle or engine. By law, vehicle owners and anyone who manufactures, repairs, services, sells, leases, trades vehicles, or supervises a fleet of vehicles are not permitted to intentionally remove an emission control device or prevent it from working. Information about your vehicle’s emission system is on the Vehicle Emission Control Information Decal located on or near the engine. This decal identifies engine displacement and gives some tune up specifications.

Please consult your *Warranty Guide* for complete emission warranty information.

Readiness for Inspection/Maintenance (I/M) testing

In some localities, it may be a legal requirement to pass an I/M test of the on-board diagnostics system. If your “Check Engine/Service Engine Soon” light is on, refer to the description in the *Warning lights and chimes* section of the *Instrument cluster* chapter. Your vehicle may not pass the I/M test with the “Check Engine/Service Engine Soon” light on.

Maintenance and Specifications

If the vehicle's powertrain system or its battery has just been serviced, the on-board diagnostics system is reset to a "not ready for I/M test" condition. To ready the on-board diagnostics system for I/M testing, a minimum of 30 minutes of city and highway driving is necessary as described below:

- First, at least 10 minutes of driving on an expressway or highway.
- Next, at least 20 minutes driving in stop-and-go, city-type traffic with at least four idle periods.

Allow the vehicle to sit for at least eight hours without starting the engine. Then, start the engine and complete the above driving cycle. The engine must warm up to its normal operating temperature. Once started, do not turn off the engine until the above driving cycle is complete.

POWER STEERING FLUID

Refer to the scheduled maintenance guide for the service interval schedules. If adding fluid is necessary, use only MERCON® ATF.

1. Start the engine and let it run until it reaches normal operating temperature (the engine coolant temperature gauge indicator will be near the center of the normal area between H and C).
2. While the engine idles, turn the steering wheel left and right several times.
3. Turn the engine off.
4. Check the fluid level in the reservoir. It should be between the MIN and MAX lines. Do not add fluid if the level is in this range.
5. If the fluid is low, add fluid in small amounts, continuously checking the level until it reaches the range between the MIN and MAX lines. Be sure to put the cap back on the reservoir.

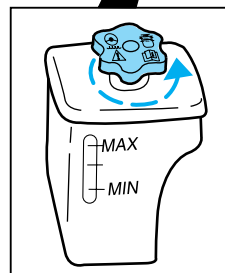
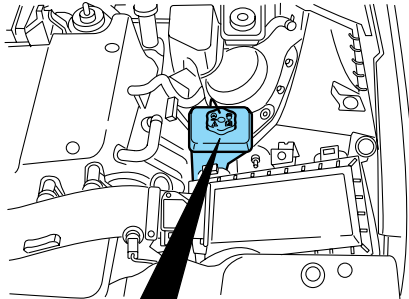

Maintenance and Specifications

BRAKE FLUID

Checking and adding brake fluid

Brake fluid should be checked and refilled as needed. Refer to the scheduled maintenance guide for the service interval schedules.

1. Clean the reservoir cap before removal to prevent dirt or water from entering the reservoir.

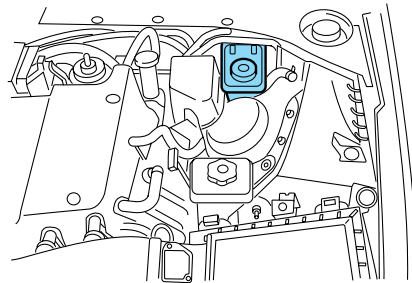

2. Visually inspect the fluid level.

3. If necessary, add brake fluid from a clean un-opened container until the level reaches MAX. Do not fill above this line.

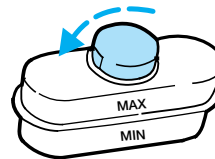

4. Use only brake fluids certified to meet Ford specification ESA-M6C25-A. Refer to *Lubricant specifications* in this chapter. DOT 3 fluid is recommended. However, if DOT 3 is not available, DOT 4 fluid can be used.



Brake fluid is toxic. If brake fluid contacts the eyes, flush eyes with running water for 15 minutes. Seek medical attention if irritation persists. If taken internally, drink water and induce vomiting. Seek medical attention immediately.



If you use DOT 5 or any other brake fluid that is not DOT 3 or DOT 4, you will cause permanent damage to your brakes.



Do not let the fluid level in the reservoir for the master cylinder fall below the MIN mark. If master cylinder runs dry, this may cause the brakes to fail.

Maintenance and Specifications

TRANSMISSION FLUID

Checking automatic transmission fluid

The 5R55N transmission does not have a transmission fluid dipstick.

Refer to your scheduled maintenance guide for scheduled intervals for fluid checks and changes. Your transmission does not consume fluid. However, the fluid level should be checked if the transmission is not working properly, i.e., if the transmission slips or shifts slowly or if you notice some sign of fluid leakage.

Transmission fluid should be checked and, if required, fluid should be added by a qualified technician.

Before adding any fluid, make sure the correct type is used. Use only MERCON® V automatic transmission fluid. The type of fluid used is indicated on the transmission fluid pan, extension housing and also in the *Lubricant specifications* section in this chapter.

Use of a non-approved automatic transmission fluid may cause internal transmission component damage and void the warranty.

Do not use supplemental transmission fluid additives, treatments or cleaning agents. The use of these materials may affect transmission operation and result in damage to internal transmission components.

AIR FILTER MAINTENANCE

Refer to the scheduled maintenance guide for the appropriate intervals for changing the air filter element.

When changing the air filter element, use only the Motorcraft air filter element listed. Refer to *Motorcraft Part Numbers*.

Note: Do not start your engine with the air cleaner removed and do not remove it while the engine is running.

Maintenance and Specifications

Changing the air filter element

1. Loosen the hose clamp on the outlet tube at the air filter housing.

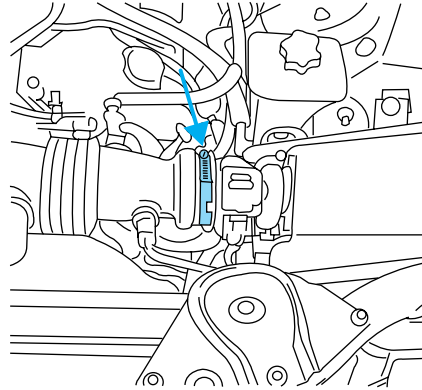

2. Release the two clamps that secure the cover to the air filter housing and place the cover aside.

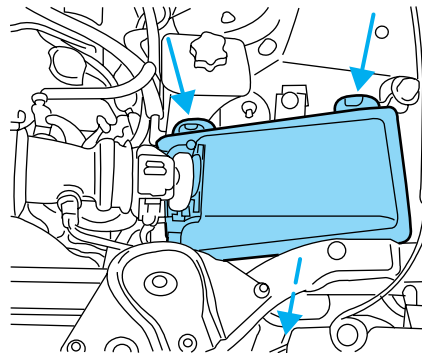

Maintenance and Specifications

3. Remove the air filter element from the air filter housing.

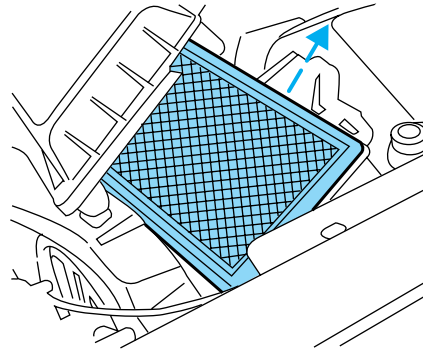

4. Wipe the air filter housing and cover clean to remove any dirt or debris and to ensure good sealing.

5. Install a new air filter element. Be careful not to crimp the filter element edges between the air filter housing and cover. This could cause filter damage and allow unmetered air to enter the engine if not properly seated.

6. Replace the air filter housing cover and secure the clamps.

INFORMATION ABOUT UNIFORM TIRE QUALITY GRADING

New vehicles are fitted with tires that have a rating on them called Tire Quality Grades. The Quality grades can be found where applicable on the tire sidewall between tread shoulder and maximum section width. For example:

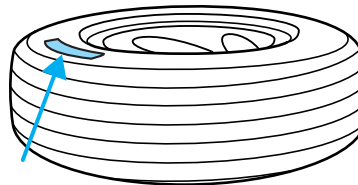

- **Treadwear 200 Traction AA Temperature A**

These Tire Quality Grades are determined by standards that the United States Department of Transportation has set.

Tire Quality Grades apply to new pneumatic tires for use on passenger cars. They do not apply to deep tread, winter-type snow tires, space-saver or temporary use spare tires, tires with nominal rim diameters of 10 to 12 inches or limited production tires as defined in Title 49 Code of Federal Regulations Part 575.104(c)(2).

U.S. Department of Transportation-Tire quality grades: The U.S. Department of Transportation requires Ford to give you the following information about tire grades exactly as the government has written it.

Maintenance and Specifications

Treadwear

The treadwear grade is a comparative rating based on the wear rate of the tire when tested under controlled conditions on a specified government test course. For example, a tire graded 150 would wear one and one-half (1 1/2) times as well on the government course as a tire graded 100. The relative performance of tires depends upon the actual conditions of their use, however, and may depart significantly from the norm due to variations in driving habits, service practices, and differences in road characteristics and climate.

Traction AA A B C

The traction grades, from highest to lowest are AA, A, B, and C. The grades represent the tire's ability to stop on wet pavement as measured under controlled conditions on specified government test surfaces of asphalt and concrete. A tire marked C may have poor traction performance.



The traction grade assigned to this tire is based on straight-ahead braking traction tests, and does not include acceleration, cornering, hydroplaning or peak traction characteristics.

Temperature A B C

The temperature grades are A (the highest), B and C, representing the tire's resistance to the generation of heat and its ability to dissipate heat when tested under controlled conditions on a specified indoor laboratory test wheel. Sustained high temperature can cause the material of the tire to degenerate and reduce tire life, and excessive temperature can lead to sudden tire failure. The grade C corresponds to a level of performance which all passenger car tires must meet under the Federal Motor Vehicle Safety Standard No. 109. Grades B and A represent higher levels of performance on the laboratory test wheel than the minimum required by law.



The temperature grade for this tire is established for a tire that is properly inflated and not overloaded. Excessive speed, underinflation, or excessive loading, either separately or in combination, can cause heat buildup and possible tire failure.

Maintenance and Specifications

SERVICING YOUR TIRES

Checking the tire pressure

- Use an accurate tire pressure gauge.
- Check the tire pressure when tires are cold, after the vehicle has been parked for at least one hour or has been driven less than 5 km (3 miles).
- Adjust tire pressure to recommended specifications found on the tire inflation placard located on the passenger side door.



Improperly inflated tires can affect vehicle handling and can fail suddenly, possibly resulting in loss of vehicle control, vehicle rollover and/or personal injury.

Tire rotation

Because your vehicle's tires perform different jobs, they often wear differently. To make sure your tires wear evenly and last longer, rotate them as indicated in the scheduled maintenance guide. If you notice that the tires wear unevenly, have them checked.

- Four tire rotation

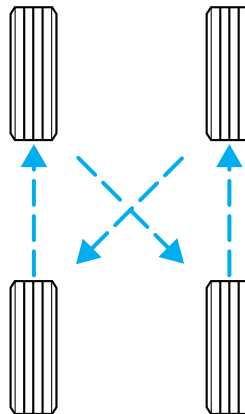



Maintenance and Specifications

Replacing the tires

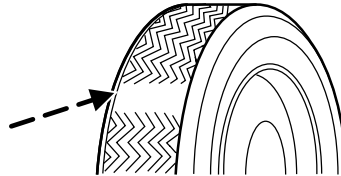
Replace the tires when the wear band is visible through the tire treads.



 When replacing full size tires, never mix radial bias-belted, or bias-type tires. Use only the tire sizes that are listed on the Certification or Tire Label. Make sure that all tires are the same size, speed rating, and load-carrying capacity. Use only the tire combinations recommended on the label. If you do not follow these precautions, your vehicle may not drive properly and safely.

 Make sure that all replacement tires are of the same size, type, load-carrying capacity and tread design (e.g., “All Terrain”, “Touring”, etc.), as originally offered by Ford.

 Failure to follow these precautions may adversely affect the handling of the vehicle, and increase the risk of loss of vehicle control, vehicle rollover and/or personal injury.

Tires that are larger or smaller than your vehicle’s original tires may also affect the accuracy of your speedometer.

SNOW TIRES AND CHAINS

 Driving too fast for conditions creates the possibility of loss of vehicle control.

 Snow tires must be the same size and grade as the tires you currently have on your vehicle.

Driving at very high speeds for extended periods of time may result in damage to vehicle components.

The tires on your vehicle have all-weather treads that provide traction in rain or snow.

Maintenance and Specifications

The use of snow cables is not recommended for this vehicle, as damage to your vehicle may occur under extreme handling or rough road conditions. However, if you choose to operate the vehicle with snow cables, avoid these conditions and follow the manufacturer's recommendations.

Do not use any type of tire chains, as this will likely cause damage to your vehicle.

MOTORCRAFT PART NUMBERS

Component	3.9L-4V V8 engine
Air filter element	FA-1679
Fuel filter	FG-986
Battery	BXT-66-650
Oil filter	FL-2008
PCV valve	N/A
Spark plugs*	AGSP-32F

* Refer to Vehicle Emissions Control Information (VECI) decal for spark plug information.

REFILL CAPACITIES

Fluid	Ford Part Name	Application	Capacity
Brake fluid	High Performance DOT 3 Motor Vehicle Brake Fluid ¹	All	Fill to MAX line on reservoir
Engine oil (includes filter change)	Motorcraft SAE 5W-20 Premium Synthetic Blend Motor Oil	3.9L-4V V8 engine	5.7L (6.0 quarts)

Maintenance and Specifications

Fluid	Ford Part Name	Application	Capacity
Engine coolant ²	Motorcraft Premium Engine Coolant (green-colored) or Motorcraft Premium Gold Engine Coolant (yellow-colored)	3.9L-4V V8 engine	11.3L (11.9 quarts)
Power steering fluid	Motorcraft MERCON® ATF	All	Fill to MAX line on reservoir
Engine cooling fan fluid	Motorcraft MERCON® ATF	All	Fill to MAX line on reservoir
Rear axle ³	Motorcraft SAE 75W-140 High Performance Synthetic Rear Axle Lubricant	All	1.4L (2.9-3.0 pints)
Fuel tank	N/A	All	68.2L (18.0 gallons)
Transmission fluid ⁴	Motorcraft MERCON®V ATF	Automatic (5R55N)	11.2L (11.9 quarts) ⁵
Windshield washer fluid	Ultra-Clear Windshield Washer Concentrate	All	Fill to line on reservoir

¹Use only brake fluids certified to meet Ford specifications. Refer to *Lubricant Specifications* in this chapter. DOT 3 fluid is recommended. However, if DOT 3 is not available, DOT 4 fluid can be used.

²Add the coolant type originally equipped in your vehicle.

³Your vehicle's rear axle is filled with a synthetic rear axle lubricant and is considered lubricated for life. These lubricants do not need to be checked or changed unless a leak is suspected, service is required or the axle assembly has been submerged in water. The axle lubricant should

Maintenance and Specifications

be changed any time the rear axle has been submerged in water. Fill 6 mm to 14 mm (1/4 inch to 9/16 inch) below bottom of fill hole.

⁴Ensure the correct automatic transmission fluid is used. MERCON® and MERCON® V are not interchangeable. DO NOT MIX MERCON® and MERCON® V. Refer to the scheduled maintenance guide to determine the correct service interval.

⁵Approximate dry capacity, includes cooler and tubes. Fluid level should be checked by a qualified service technician.

LUBRICANT SPECIFICATIONS

Item	Ford part name	Ford part number	Ford specification
Brake fluid	Motorcraft High Performance DOT 3 Motor Vehicle Brake Fluid ¹	PM-1	ESA-M6C25-A and DOT 3
Door weatherstrips	Silicone Lubricant	F5AZ-19553-AA	ESR-M13P4-A
Door latch, hood latch, auxiliary hood latch, door hinges, striker plates, seat tracks and fuel filler door hinge	Multi-Purpose Grease	XL-4 or XL-5	ESB-M1C93-B or ESR-M1C159-A
Engine coolant	Motorcraft Premium Engine Coolant (green-colored)	VC-4-A (US) or CXC-10 (Canada)	ESE-M97B44-A
	Motorcraft Premium Gold Engine Coolant (yellow-colored)	VC-7-A (VC-7-B in Oregon)	WSS-M97B51-A1

Maintenance and Specifications

Item	Ford part name	Ford part number	Ford specification
Engine oil	Motorcraft SAE 5W-20 Premium Synthetic Blend Motor Oil	XO-5W20-QSP	WSS-M2C153-H with API Certification Mark
Lock cylinders	Motorcraft Penetrating and Lock Lubricant	XL-1	none
Power steering and engine cooling fan fluid	Motorcraft MERCON® ATF	XT-2-QDX	MERCON®
Rear Axle Lubricant	Motorcraft SAE 75W-140 High Performance Synthetic Rear Axle Lubricant ²	XY-75W140-QL	WSL-M2C192-A
Automatic transmission fluid	Motorcraft MERCON®V ATF ³	XT-5-QM	MERCON®V
Windshield washer fluid	Motorcraft Premium Windshield Washer Concentrate	ZC-32-A	WSB-M8B16-A2

¹Use only brake fluids certified to meet Ford specifications. DOT 3 fluid is recommended. However, if DOT 3 is not available, DOT 4 fluid can be used.

²Ford design rear axles contain a synthetic lubricant that does not require changing unless the axle has been submerged in water.

³Ensure the correct automatic transmission fluid is used. MERCON® and MERCON® V are not interchangeable. DO NOT MIX MERCON® and MERCON® V. Refer to the scheduled maintenance guide to determine the correct service interval.

Maintenance and Specifications

ENGINE DATA

Engine	3.9L-4V V8 engine
Displacement	3 949 cc (241 cid)
Required fuel	91 octane
Firing order	1-5-4-2-6-3-7-8
Spark plug gap	0.99-1.09 mm (0.039-0.043 inch)
Ignition system	Coil on plug
Compression ratio	10.55:1

VEHICLE DIMENSIONS

Vehicle dimensions	mm (in)
(1) Overall length	4732mm (186.3 in)
(2) Overall width	1829mm (72.0 in)
(3) Overall height	1323 mm (52.1 in)
(4) Wheelbase	2722 mm (107.2 in)
(5) Track - Front	1537 mm (60.5 in)
(5) Track - Rear	1529 mm (60.2 in)

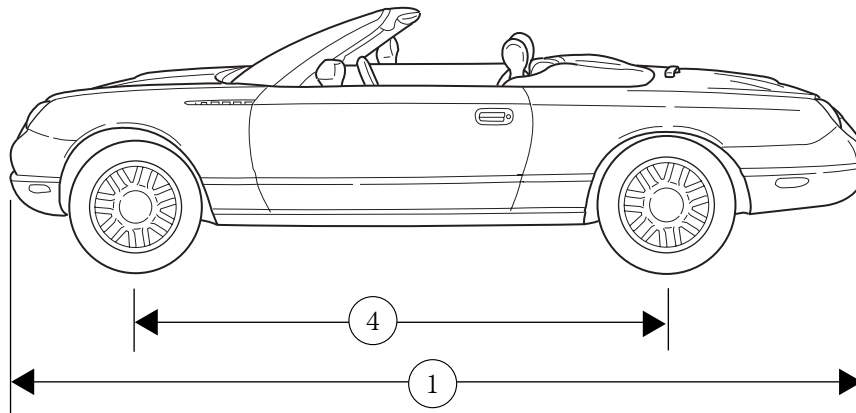

Maintenance and Specifications

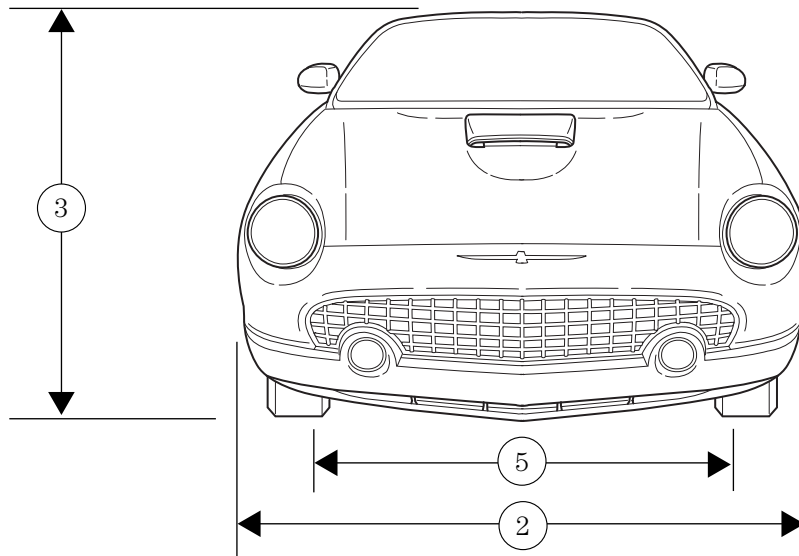

IDENTIFYING YOUR VEHICLE

Certification label

The National Highway Traffic Safety Administration Regulations require that a Certification label be affixed to a vehicle and prescribe where the Certification label may be located. The Certification label is located on the front door latch pillar on the driver's side.

MFD. BY FORD MOTOR CO. IN U.S.A.			
DATE: XXXXX	GVWR:XXXXXXXXXXXX		
FRONT GAWR: XXXXXXX/XXXXXXXX			
REAR GAWR: XXXXXXX/XXXXXXXX			
THIS VEHICLE CONFORMS TO ALL APPLICABLE FEDERAL MOTOR VEHICLE SAFETY, BUMPER, AND THEFT PREVENTION STANDARDS IN EFFECT ON THE DATE OF MANUFACTURE SHOWN ABOVE.			
VIN: XXXXXXXXXXXXXXXXXXXX		XXXXX	
TYPE: XXXXXXXXXXXXXXXX		XXXXX	
			
EXT PNT: XXXXX XXXXX	JRC: XX	DSD: XXXX	
BAR INT TR TP/PS TR AXLE TR SPR			
X XX XXX X XX X XXXX			
UPC VF85B-1520472-AB			

FORD ACCESSORIES FOR YOUR VEHICLE

A wide selection of genuine Ford accessories are available for your vehicle through your local authorized Ford, Lincoln, Mercury or Ford of Canada dealer. These quality accessories have been specifically engineered to fulfill your automotive needs; they are custom designed to complement the style and aerodynamic appearance of your vehicle. In addition, each accessory is made from high quality materials and meets or exceeds Ford's rigorous engineering and safety specifications. Ford Motor Company will repair or replace any properly dealer-installed Ford accessory found to be defective in factory-supplied materials or workmanship during the warranty period, as well as any component damaged by the defective accessory. The accessory will be warranted for whichever provides you the greatest benefit:

- 12 months or 20,000 km (12,000 miles) (whichever occurs first), or
- the remainder of your new vehicle limited warranty.

This means that genuine Ford accessories purchased along with your new vehicle and installed by the dealer are covered for the full length of your New Vehicle's Limited Warranty — 3 years or 60,000 km (36,000 miles) (whichever occurs first). Contact your dealer for details and a copy of the warranty.

Not all accessories are available for all models.

Vehicle Security

Non decorative wheel locks
Vehicle security systems

Comfort and convenience

Cargo nets
Engine block heaters
Remote start system

Protection and appearance equipment

Air bag anti-theft locks
All weather floor mats
Ash cup
Car covers
Cargo liners, interior

Accessories

Carpet floor mats

First aid kit

Front end cover

Highway safety kit

Locking gas cap

For maximum vehicle performance, keep the following information in mind when adding accessories or equipment to your vehicle:

- When adding accessories, equipment, passengers and luggage to your vehicle, do not exceed the total weight capacity of the vehicle or of the front or rear axle (GVWR or GAWR as indicated on the Safety compliance certification label). Consult your dealer for specific weight information.
- The Federal Communications Commission (FCC) and Canadian Radio Telecommunications Commission (CRTC) regulate the use of mobile communications systems - such as two-way radios, telephones and theft alarms - that are equipped with radio transmitters. Any such equipment installed in your vehicle should comply with FCC or CRTC regulations and should be installed only by a qualified service technician.
- Mobile communications systems may harm the operation of your vehicle, particularly if they are not properly designed for automotive use or are not properly installed. When operated, such systems may cause the engine to stumble or stall. In addition, such systems may be damaged or their performance may be affected by operating your vehicle. If you intend on fitting a mobile radio such as a citizens band radio (CB), please refer to your local dealer for Ford recommended installation guidelines. Ask you dealer to reference the "Ford Mobile Radio Installation Guidelines." (Citizens band [CB] transceivers, garage door openers and other transmitters with outputs of five watts or less will not ordinarily affect your vehicle's operation.)
- Ford cannot assume responsibility for any adverse effects or damage that may result from the use of such equipment.

Index

A

- ABS (see Brakes)129
- Accessory delay57
- Air bag supplemental restraint system100–101, 109
 - and child safety seats102
 - description101, 109
 - disposal113
 - driver air bag102, 111
 - indicator light10, 104, 112
 - operation102, 111
 - passenger air bag102, 111
 - passenger deactivation switch105
 - side air bag109
- Air cleaner filter210–211, 216
- Air conditioning30
- Air filter, cabin42
- Antifreeze (see Engine coolant)192
- Anti-lock brake system (see Brakes)129–130
- Anti-theft system85
 - arming the system85–86
 - disarming a triggered system86
- Audio system (see Radio)16
- Automatic transmission
 - driving an automatic overdrive134
 - fluid, adding210
 - fluid, checking210
 - fluid, refill capacities216
 - fluid, specification220
- Auxiliary power point56

Axle

- lubricant
- specifications218, 220
- refill capacities216

B

- Battery190
 - acid, treating emergencies190
 - charging system warning light11
 - jumping a disabled battery161
 - maintenance-free190
 - replacement, specifications ...216
 - servicing190
- BeltMinder96
- Brakes129
 - anti-lock129–130
 - anti-lock brake system (ABS) warning light10, 130
 - brake warning light9
 - fluid, checking and adding209
 - fluid, refill capacities216
 - fluid, specifications218, 220
 - lubricant specifications218, 220
 - parking131
 - shift interlock133
- Break-in period5
- Bulbs46

C

- Capacities for refilling fluids216
- Cassette tape player16
- Certification Label221
- Changing a tire156
- Child safety restraints113
 - child safety belts113
- Child safety seats116

Index

- attaching with tether
 - straps120
 - in front seat117
 - in rear seat117
 - LATCH123
 - Cleaning your vehicle
 - engine compartment179
 - instrument panel181
 - interior181–182
 - plastic parts180
 - washing178
 - waxing178
 - wheels179
 - wiper blades180
 - Clock27
 - Console75
 - Controls
 - power seat88
 - steering column63
 - Convertible64
 - cleaning68, 181
 - installation of the boot65
 - lowering the convertible top ...64
 - raising the convertible top66
 - Coolant
 - checking and adding192
 - coolant temperature light11
 - refill capacities196, 216
 - specifications218, 220
 - Cruise control
 - (see Speed control)59
 - Customer Assistance145
 - Ford accessories for your vehicle183
 - Ford Extended Service Plan170
 - Getting assistance outside the U.S. and Canada174
 - Getting roadside assistance ...145
 - Getting the service you need168
 - Ordering additional owner's literature175
 - The Dispute Settlement Board171
 - Utilizing the Mediation/Arbitration Program174
- ### D
- Daytime running lamps
 - (see Lamps)43
 - Defrost
 - rear window42
 - Dipstick
 - automatic transmission fluid210
 - engine oil187
 - Doors
 - door ajar warning13
 - lubricant specifications218
 - Driving under special conditions
 - through water139
 - Dual automatic temperature control (DATC)30
- ### E
- Emergencies, roadside
 - jump-starting161
 - Emission control system206
 - Engine220
 - check engine/service engine soon light8
 - cleaning179
 - coolant192
 - fail-safe coolant197

Index

- idle speed control190
- lubrication
 - specifications218, 220
 - refill capacities216
 - service points186
 - starting after a collision146
- Engine block heater128
- Engine fan198
- Engine oil187
 - checking and adding187
 - dipstick187
 - filter, specifications189, 216
 - recommendations189
 - refill capacities216
 - specifications218, 220
- Exhaust fumes128
- F**
- Fail safe cooling197
- Floor mats75
- Fluid capacities216
- Fuel199
 - calculating fuel economy203
 - cap9, 201
 - capacity216
 - choosing the right fuel201
 - comparisons with EPA fuel economy estimates206
 - detergent in fuel202
 - filling your vehicle with fuel199, 201, 203
 - filter, specifications203, 216
 - fuel pump shut-off switch146
 - gauge15
 - improving fuel economy203
 - low fuel warning light12
 - octane rating202, 220
 - quality202
 - running out of fuel203
 - safety information relating to automotive fuels199
- Fuses147–148
- G**
- Gas cap (see Fuel cap)9, 201
- Gas mileage (see Fuel economy)203
- Gauges14
 - engine coolant temperature gauge14
 - fuel gauge15
 - odometer15
 - speedometer15
 - tachometer15
 - trip odometer15
- GAWR (Gross Axle Weight Rating)139
 - definition139
 - driving with a heavy load139
 - location139
- GVWR (Gross Vehicle Weight Rating)139
 - calculating139
 - definition139
 - driving with a heavy load139
 - location139
- H**
- Hazard flashers146
- Head restraints87
- Headlamps43
 - aiming45
 - autolamp system43
 - bulb specifications47
 - daytime running lights43
 - flash to pass44
 - high beam12

Index

- replacing bulbs48
 - turning on and off43
 - warning chime13
 - Heating
 - heating and air conditioning system30
 - Hood185
 - I**
 - Ignition125, 220
 - Infant seats
(see Safety seats)116
 - Inspection/maintenance (I/M)
testing207
 - Instrument panel
 - cleaning181
 - cluster8
 - lighting up panel and interior44
 - J**
 - Jack156
 - positioning156
 - storage156
 - Jump-starting your vehicle161
 - K**
 - Keyless entry system
 - autolock81
 - Keys82–84
 - key in ignition chime13
 - positions of the ignition125
 - L**
 - Lamps
 - autolamp system43
 - bulb replacement
 - specifications chart47
 - cargo lamps44
 - daytime running light43
 - headlamps43
 - headlamps, flash to pass44
 - instrument panel, dimming44
 - interior lamps46–47
 - replacing bulbs46, 48, 50–53
- Lane change indicator
(see Turn signal)46
 - Lights, warning and indicator8
 - air bag10
 - anti-lock brakes (ABS)10, 130
 - brake9
 - bulb warning12
 - charging system11
 - check engine8
 - cruise indicator12
 - door ajar13
 - fuel cap light9
 - high beam12
 - low coolant11
 - low fuel12
 - low washer fluid12
 - oil pressure11
 - safety belt11
 - speed control63
 - traction control active11
 - transmission PRNDL
 - indicator10
 - turn signal indicator12
 - Load limits139
 - GAWR139
 - GVWR139
 - trailer towing139
 - Locks
 - autolock81
 - doors76
 - Lubricant specifications ...218, 220
 - Lug nuts, anti-theft160

Index

- Lumbar support, seats88
- M**
- Manual transmission
fluid capacities216
lubricant specifications220
- Master lighting switch43
- Mirrors
side view mirrors (power)58
- Motorcraft parts203, 216
- O**
- Octane rating202
- Odometer15
- Oil (see Engine oil)187
- P**
- Panic alarm feature, remote
entry system79
- Parking brake131
- Parts (see Motorcraft parts)216
- Power distribution box
(see Fuses)151, 154
- Power door locks76, 81
- Power mirrors58
- Power point56
- Power steering133
fluid, checking and adding208
fluid, refill capacity216
fluid, specifications218, 220
- Power Windows56
- R**
- Radio16
- Radio reception28–29
- Rear window defroster42
- Relays147
- Remote entry system77, 79
illuminated entry81
locking/unlocking
doors76, 78–79
opening the trunk79
panic alarm79
replacement/additional
transmitters80
replacing the batteries80
- Roadside assistance145
- S**
- Safety belts (see Safety
restraints)13, 90–94
- Safety defects, reporting177
- Safety restraints90–95
belt minder96
cleaning the safety belts99
extension assembly99
for adults91–94
for children113
warning light and
chime11, 13, 95–96
- Safety seats for children116
- Seat belts
(see Safety restraints)90
- Seats87
child safety seats116
cleaning181
- SecuriLock passive anti-theft
system82–84
- Servicing your vehicle184
- Spare tire (see Changing the
Tire)156

Index

- Spark plugs, specifications216, 220
- Specification chart, lubricants218, 220
- Speed control59
- Speedometer15
- Starting your vehicle125–127
 - jump starting161
- Steering
 - speed sensitive133
- Steering wheel
 - controls55, 59, 63
 - tilting55
- T**
- Tachometer15
- Tires156, 212–214
 - changing156–157
 - checking the pressure214
 - replacing215
 - rotating214
 - snow tires and chains215
 - tire grades213
 - treadwear213
- Towing141
 - recreational towing144
 - trailer towing141
 - wrecker167
- Traction control131
 - active light11
- Transmission10, 133
 - fluid, checking and adding (automatic)210
 - fluid, refill capacities216
 - lubricant specifications218, 220
 - manual operation10
- Trip odometer15
- Trunk76
 - remote release59, 79
- Turn signal12–13, 46
- V**
- Vehicle dimensions220
- Vehicle Identification Number (VIN)222
- Vehicle loading139
- Ventilating your vehicle129
- W**
- Warning chimes13
- Warning lights (see Lights)8
- Water, Driving through139
- Windows
 - power56
- Windshield washer fluid and wipers
 - checking and cleaning54
 - operation54
 - replacing wiper blades55
- Wrecker towing167

Free Manuals Download Website

<http://myh66.com>

<http://usermanuals.us>

<http://www.somanuals.com>

<http://www.4manuals.cc>

<http://www.manual-lib.com>

<http://www.404manual.com>

<http://www.luxmanual.com>

<http://aubethermostatmanual.com>

Golf course search by state

<http://golfingnear.com>

Email search by domain

<http://emailbydomain.com>

Auto manuals search

<http://auto.somanuals.com>

TV manuals search

<http://tv.somanuals.com>