



INSTALL GUIDE

**FortiGate-50A/50B,
FortiWiFi-50B and
FortiGate-100
FortiOS 3.0 MR4**

FORTINET™

www.fortinet.com

FortiGate-50A/50B, FortiWiFi-50B and FortiGate-100 Install Guide
FortiOS 3.0 MR4
31 August 2007
01-30004-0265-20070831

© Copyright 2007 Fortinet, Inc. All rights reserved. No part of this publication including text, examples, diagrams or illustrations may be reproduced, transmitted, or translated in any form or by any means, electronic, mechanical, manual, optical or otherwise, for any purpose, without prior written permission of Fortinet, Inc.

Trademarks

Dynamic Threat Prevention System (DTPS), APSecure, FortiASIC, FortiBIOS, FortiBridge, FortiClient, FortiGate, FortiGate Unified Threat Management System, FortiGuard, FortiGuard-Antispam, FortiGuard-Antivirus, FortiGuard-Intrusion, FortiGuard-Web, FortiLog, FortiAnalyzer, FortiManager, Fortinet, FortiOS, FortiPartner, FortiProtect, FortiReporter, FortiResponse, FortiShield, FortiVoIP, and FortiWiFi are trademarks of Fortinet, Inc. in the United States and/or other countries. The names of actual companies and products mentioned herein may be the trademarks of their respective owners.

Regulatory compliance

FCC Class A Part 15 CSA/CUS



Caution: Risk of Explosion if Battery is replaced by an Incorrect Type.
Dispose of Used Batteries According to the Instructions.

Contents

Contents	3
Introduction	7
About the FortiGate unit	7
FortiGate-50A.....	7
FortiGate-50B.....	8
FortiWiFi-50B	8
FortiGate-100	8
Register your FortiGate unit	8
Fortinet Family Products	9
FortiGuard Subscription Services	9
FortiClient.....	9
FortiMail	9
FortiAnalyzer	10
FortiReporter	10
FortiBridge.....	10
FortiManager.....	10
About this document	10
Document conventions.....	11
Typographic conventions.....	11
Fortinet documentation	12
Fortinet Tools and Documentation CD.....	13
Fortinet Knowledge Center	13
Comments on Fortinet technical documentation	13
Customer service and technical support	13
Installing the FortiGate unit	15
Package Contents	15
FortiGate-50A.....	15
FortiGate-50B.....	16
FortiWiFi-50B	17
FortiGate-100	17
Warnings	18
Mounting	19
Powering on the FortiGate unit	19
Power over Ethernet	20
Powering off the FortiGate unit	21

Connecting to the FortiGate unit	21
Web-based manager	21
Command line interface	21
Connecting to the web-based manager	21
Command line interface	23
Connecting to the CLI	23
Quick installation using factory defaults	24
Factory defaults	27
Factory default DHCP server configuration	28
Factory default NAT/Route mode network configuration	28
Factory default Transparent mode network configuration	29
Factory default firewall configuration	29
Factory default protection profiles	30
Restoring the default settings	31
Restoring the default settings using the web-based manager	31
Restoring the default settings using the CLI	31
Configuring the FortiGate unit.....	33
Planning the FortiGate configuration	33
NAT/Route mode	33
NAT/Route mode with multiple external network connections	34
Transparent mode.....	35
Preventing the public interface from responding to ping requests	35
NAT/Route mode installation	36
Preparing to configure the FortiGate unit in NAT/Route mode	36
DHCP or PPPoE configuration	37
Using the web-based manager	37
Configuring basic settings	37
Adding a default route	38
Verifying the web-based manager configuration	39
Verify the connection	39
Using the command line interface.....	39
Configuring the FortiGate unit to operate in NAT/Route mode.....	39
Adding a default route	41
Connecting the FortiGate unit to the network(s)	42
Configuring the networks	42
Transparent mode installation	43
Preparing to configure Transparent mode	43
Using the web-based manager	43
Using the command line interface.....	44
Connecting the FortiGate unit to your network	45

Next steps	46
Set the date and time	46
Updating antivirus and IPS signatures	47
Updating antivirus and IPS signatures from the web-based manager .	47
Updating the IPS signatures from the CLI	48
Scheduling antivirus and IPS updates	48
Adding an override server	49
Configuring the modem interface	51
Connecting a modem to the FortiGate-50A	51
Selecting a modem mode	52
Redundant mode configuration	52
Stand alone mode configuration	52
Configuring the modem for the FortiGate-50A	53
Adding a Ping Server	55
Dead gateway detection	55
Adding firewall policies for modem connections.....	56
Using a wireless network	57
Setting up a wireless network	57
Positioning an Access Point.....	58
Radio Frequency interface	58
Using multiple access points.....	59
Wireless Security.....	60
Wireless Equivalent Privacy (WEP)	60
Wi-Fi Protected Access (WPA)	60
Additional security measures	61
MAC address filtering	61
Service Set Identifier	61
FortiWiFi-50B operation modes	61
Access Point mode	61
Client mode	62
Changing the operating mode	63
Setting up the FortiWiFi-50B as an Access Point	63
Set the DHCP settings	63
Set the security options.....	64
Configure the firewall policies	64
FortiGate Firmware	65
Upgrading to a new firmware version	65
Upgrading the firmware using the web-based manager	65
Upgrading the firmware using the CLI	66

Reverting to a previous firmware version.....	67
Reverting to a previous firmware version using the web-based manager ..	67
Reverting to a previous firmware version using the CLI	68
Installing firmware images from a system reboot using the CLI.....	70
Restoring the previous configuration	72
The FortiUSB key.....	73
Backup and Restore from the FortiUSB key	73
Using the USB Auto-Install feature	74
Additional CLI commands for the FortiUSB key.....	75
Testing a new firmware image before installing it	75
Installing and using a backup firmware image.....	77
Installing a backup firmware image.....	77
Index.....	81

Introduction

Welcome and thank you for selecting Fortinet products for your real-time network protection.

FortiGate™ Unified Threat Management System improves network security, reduces network misuse and abuse, and helps you use communications resources more efficiently without compromising the performance of your network. FortiGate Unified Threat Management Systems are ICASA-certified for firewall, IPSec, and antivirus services.

The FortiGate Unified Threat Management System is a dedicated, easily managed security device that delivers a full suite of capabilities, which include:

- application-level services such as virus protection and content filtering
- network-level services such as firewall, intrusion detection, VPN and traffic shaping

The FortiGate Unified Threat Management System uses Fortinet's Dynamic Threat Prevention System (DTPS™) technology, which leverages breakthroughs in chip design, networking, security and content analysis. The unique ASIC-based architecture analyzes content and behavior in real-time, enabling key applications to be deployed right at the network edge where they are most effective at protecting your networks.

About the FortiGate unit

The FortiGate-50A/50B, FortiWiFi-50B and FortiGate-100 appliances are designed for SOHO and SMB offices, to deliver the same enterprise-class network-based antivirus, content filtering, firewall, VPN, and network-based intrusion detection/prevention featured in all FortiGate units.

FortiGate-50A

The FortiGate-50A is designed for telecommuters and small remote offices with 10 or fewer employees. The FortiGate-50A unit includes an external modem port that can be used as a backup or stand alone connection to the Internet.

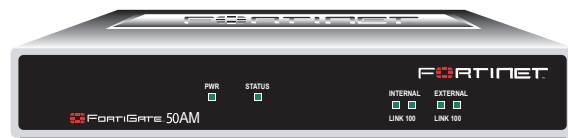

FortiGate-50B

The FortiGate-50B is designed for telecommuters and small remote offices with 10 to 50 employees. The FortiGate-50B unit includes two WAN ports for a redundant connection to the Internet. It also features a 3-port switch for connecting additional network connections and supports HA configurations with additional FortiGate-50B units.

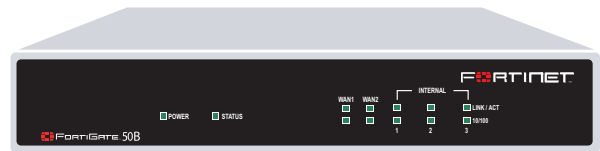

FortiWiFi-50B

The FortiWiFi-50B is designed for telecommuters and small remote offices with 10 to 50 employees. The FortiWiFi-50B unit includes two WAN ports for a redundant connection to the Internet. It also features a 3-port switch for connecting additional network connections and supports HA configurations with additional FortiWiFi-50B units. The FortiWiFi-50B includes Power over Ethernet (PoE) capabilities as a Powered Device through the WAN1 port.

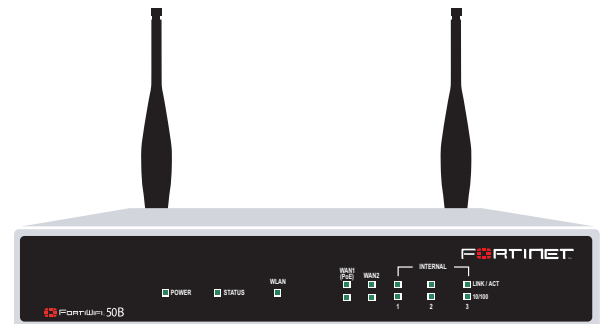

FortiGate-100

The FortiGate-100 unit is designed for SOHO, SMB and branch office applications.

The FortiGate-100 supports advanced features such as 802.1Q VLAN, virtual domains, high availability (HA), and the RIP and OSPF routing protocols.

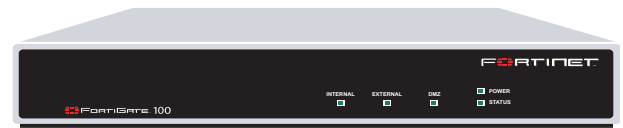

Register your FortiGate unit

Register your FortiGate unit by visiting <http://support.fortinet.com> and selecting Product Registration.

To register, enter your contact information and the serial numbers of the FortiGate units that you or your organization have purchased. You can register multiple FortiGate units in a single session without re-entering your contact information.

By registering your FortiGate unit, you will receive updates to threat detection and prevention databases (Antivirus, Intrusion Detection, etc.) and will also ensure your access to technical support.

Fortinet Family Products

Fortinet offers a family of products that includes both software and hardware appliances for a complete network security solution including mail, logging, reporting, network management, and security along with FortiGate Unified Threat Management Systems. For more information on the Fortinet product family, go to www.fortinet.com/products.

FortiGuard Subscription Services

FortiGuard Subscription Services are security services created, updated and managed by a global team of Fortinet security professionals. They ensure the latest attacks are detected and blocked before harming your corporate resources or infecting your end-user computing devices. These services are created with the latest security technology and designed to operate with the lowest possible operational costs.

FortiGuard Subscription Services includes:

- FortiGuard Antivirus Service
- FortiGuard Intrusion Prevention subscription services (IPS)
- FortiGuard Web Filtering
- FortiGuard Antispam Service
- FortiGuard Premier Service

An online virus scanner and virus encyclopedia is also available for your reference.

FortiClient

FortiClient™ Host Security software provides a secure computing environment for both desktop and laptop users running the most popular Microsoft Windows operating systems. FortiClient offers many features including:

- creating VPN connections to remote networks
- configuring real-time protection against viruses
- guarding against modification of the Windows registry
- virus scanning

FortiClient also offers a silent installation feature, enabling an administrator to efficiently distribute FortiClient to several users' computers with preconfigured settings.

FortiMail

FortiMail™ Secure Messaging Platform provides powerful, flexible heuristic scanning and reporting capabilities to incoming and outgoing email traffic. The FortiMail unit has reliable, high performance features for detecting and blocking malicious attachments such as Distributed Checksum Clearinghouse (DCC) scanning and Bayesian scanning. Built on Fortinet's award winning FortiOS and FortiASIC technology, FortiMail antivirus technology extends full content inspection capabilities to detect the most advanced email threats.

FortiAnalyzer

FortiAnalyzer™ provides network administrators with the information they need to enable the best protection and security for their networks and monitor against attacks and vulnerabilities. The FortiAnalyzer unit features include:

- collecting logs from FortiGate, FortiManager, FortiMail devices and syslog devices
- generating reports on network use, vulnerabilities, and traffic patterns.
- storing quarantined files from a FortiGate unit and archived content from email and IM conversations.

The FortiAnalyzer unit can also be configured as a network analyzer to capture real-time traffic on areas of your network where firewalls are not employed. You can also use the unit as a storage device where users can access and share files, including the reports and logs that are saved on the FortiAnalyzer hard disk.

FortiReporter

FortiReporter™ Security Analyzer software generates easy-to-understand reports and can collect logs from any FortiGate unit, as well as over 30 network and security devices from third-party vendors. FortiReporter reveals network abuse, manages bandwidth requirements, monitors web usage, and ensures employees are using the office network appropriately. FortiReporter allows IT administrators to identify and respond to attacks, including identifying ways to proactively secure their networks before security threats arise.

FortiBridge

FortiBridge™ products are designed to provide enterprise organizations with continuous network traffic flow in the event of a power outage or a FortiGate system failure. The FortiBridge unit bypasses the FortiGate unit to ensure that the network can continue processing traffic. FortiBridge products are easy to use and deploy, and you can customize the actions a FortiBridge unit takes when a power failure or a FortiGate system failure occurs.

FortiManager

The FortiManager™ system is designed to meet the needs of large enterprises (including managed security service providers) responsible for establishing and maintaining security policies across many dispersed FortiGate installations. With this system, you can configure multiple FortiGate devices and monitor their status. You can also view real-time and historical logs for the FortiGate devices, including updating firmware images of managed FortiGate devices. The FortiManager System emphasizes ease of use, including easy integration with third party systems.

About this document

This document explains how to install and configure your FortiGate unit onto your network. This document also includes how to install and upgrade new firmware versions on your FortiGate unit.

This document contains the following chapters:

- [Installing the FortiGate unit](#) – Describes unpacking, setting up, and powering on a FortiGate unit.
- [Factory defaults](#) – Provides the factory default settings for the FortiGate unit
- [Configuring the FortiGate unit](#) – Provides an overview of the operating modes of the FortiGate unit and how to integrate the FortiGate unit into your network.
- [Configuring the modem interface](#) – Describes how to configure and use a modem with the FortiGate-50A and FortiGate-50AM units.
- [Using a wireless network](#) – Describes configuring a wireless network and positioning the FortiWiFi-50B unit for best reception.
- [FortiGate Firmware](#) – Describes how to install, update, restore and test the firmware for the FortiGate device.



Note: This guide covers information on four FortiGate units; the FortiGate-50A, FortiGate-50B, FortiWiFi-50B and FortiGate-100. While most of the content applies to all the units, where information is specific to a certain model, an icon like the ones below will appear next to the content.



Document conventions

The following document conventions are used in this guide:

- In the examples, private IP addresses are used for both private and public IP addresses.
- Notes and Cautions are used to provide important information:



Note: Highlights useful additional information.



Caution: Warns you about commands or procedures that could have unexpected or undesirable results including loss of data or damage to equipment.

Typographic conventions

FortiGate documentation uses the following typographical conventions:

Convention	Example
Keyboard input	In the Gateway Name field, type a name for the remote VPN peer or client (for example, <code>Central_Office_1</code>).
Code examples	<pre>config sys global set ips-open enable end</pre>
CLI command syntax	<pre>config firewall policy edit id_integer set http_retry_count <retry_integer> set natip <address_ipv4mask> end</pre>
Document names	<i>FortiGate Administration Guide</i>
Menu commands	Go to VPN > IPSEC > Phase 1 and select Create New.
Program output	Welcome!
Variables	<address_ipv4>

Fortinet documentation

The most up-to-date publications and previous releases of Fortinet product documentation are available from the Fortinet Technical Documentation web site at <http://docs.forticare.com>.

The following [FortiGate product documentation](#) is available:

- *FortiGate QuickStart Guide*
Provides basic information about connecting and installing a FortiGate unit.
- *FortiGate Install Guide*
Describes how to install a FortiGate unit. Includes a hardware reference, default configuration information, installation procedures, connection procedures, and basic configuration procedures. Choose the guide for your product model number.
- *FortiGate Administration Guide*
Provides basic information about how to configure a FortiGate unit, including how to define FortiGate protection profiles and firewall policies; how to apply intrusion prevention, antivirus protection, web content filtering, and spam filtering; and how to configure a VPN.
- *FortiGate online help*
Provides a context-sensitive and searchable version of the *Administration Guide* in HTML format. You can access online help from the web-based manager as you work.
- *FortiGate CLI Reference*
Describes how to use the FortiGate CLI and contains a reference to all FortiGate CLI commands.
- [FortiGate Log Message Reference](#)
Available exclusively from the [Fortinet Knowledge Center](#), the FortiGate Log Message Reference describes the structure of FortiGate log messages and provides information about the log messages that are generated by FortiGate units.

- *FortiGate High Availability User Guide*
Contains in-depth information about the FortiGate high availability feature and the FortiGate clustering protocol.
- *FortiGate IPS User Guide*
Describes how to configure the FortiGate Intrusion Prevention System settings and how the FortiGate IPS deals with some common attacks.
- *FortiGate IPsec VPN User Guide*
Provides step-by-step instructions for configuring IPsec VPNs using the web-based manager.
- *FortiGate SSL VPN User Guide*
Compares FortiGate IPsec VPN and FortiGate SSL VPN technology, and describes how to configure web-only mode and tunnel-mode SSL VPN access for remote users through the web-based manager.
- *FortiGate PPTP VPN User Guide*
Explains how to configure a PPTP VPN using the web-based manager.
- *FortiGate Certificate Management User Guide*
Contains procedures for managing digital certificates including generating certificate requests, installing signed certificates, importing CA root certificates and certificate revocation lists, and backing up and restoring installed certificates and private keys.
- *FortiGate VLANs and VDOMs User Guide*
Describes how to configure VLANs and VDOMs in both NAT/Route and Transparent mode. Includes detailed examples.

Fortinet Tools and Documentation CD

All Fortinet documentation is available from the Fortinet Tools and Documentation CD shipped with your Fortinet product. The documents on this CD are current at shipping time. For up-to-date versions of Fortinet documentation see the Fortinet Technical Documentation web site at <http://docs.forticare.com>.

Fortinet Knowledge Center

Additional Fortinet technical documentation is available from the Fortinet Knowledge Center. The knowledge center contains troubleshooting and how-to articles, FAQs, technical notes, and more. Visit the Fortinet Knowledge Center at <http://kc.forticare.com>.

Comments on Fortinet technical documentation

Please send information about any errors or omissions in this document, or any Fortinet technical documentation, to techdoc@fortinet.com.

Customer service and technical support

Fortinet Technical Support provides services designed to make sure that your Fortinet systems install quickly, configure easily, and operate reliably in your network.

Please visit the Fortinet Technical Support web site at <http://support.fortinet.com> to learn about the technical support services that Fortinet provides.



Installing the FortiGate unit

This section provides information on installing and setting up the FortiGate unit on your network. This chapter includes the following sections:

- [Package Contents](#)
- [Mounting](#)
- [Powering on the FortiGate unit](#)
- [Connecting to the FortiGate unit](#)

Package Contents

Review the contents of your FortiGate package to ensure all components were included.

FortiGate-50A

The FortiGate-50A package contains the following items:

- FortiGate-50A Unified Threat Management System
- one orange crossover Ethernet cable (Fortinet part number CC300248)
- one gray straight-through Ethernet cable (Fortinet part number CC300249)
- one RJ-45 to DB-9 serial cable (Fortinet part number CC300247)
- one AC adapter and power cable
- FortiGate-50A QuickStart Guide
- Fortinet Tools and Documentation CD

Figure 1: FortiGate-50A package contents

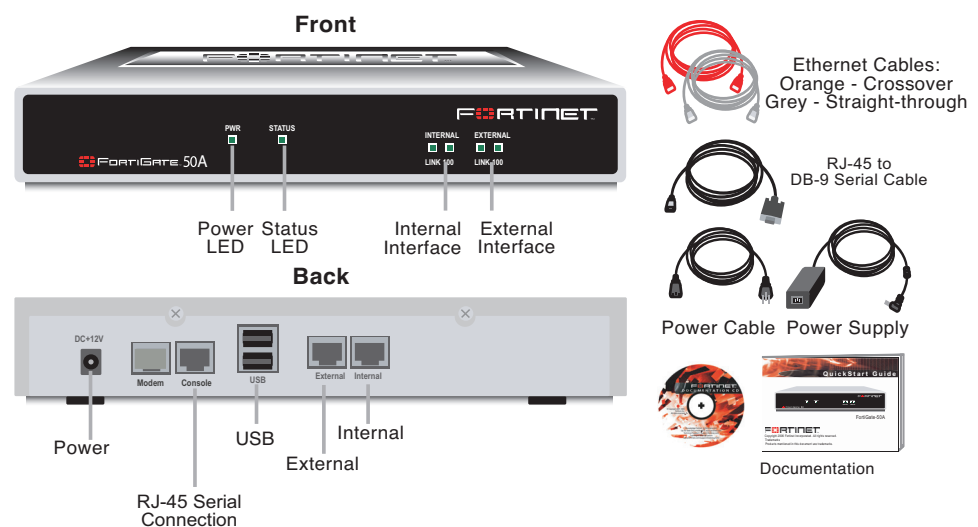

Table 1: Technical Specifications

Dimensions	8.63 x 6.13 x 1.38 in. (21.9 x 15.6 x 3.5 cm)
Weight	1.5 lb. (0.68 kg)
Power Requirements	DC input voltage: 12V DC input current: 3A
Environmental Specifications	Operating temperature: 32 to 104 F (0 to 40 C) Storage temperature: -13 to 158 F (-25 to 70 C) Humidity: 5 to 95% non-condensing

FortiGate-50B

The FortiGate-50B package contains the following items:

- FortiGate-50B Unified Threat Management System
- one gray straight-through Ethernet cable (Fortinet part number CC300249)
- one RJ-45 to DB-9 serial cable (Fortinet part number CC300247)
- one AC adapter and power cable
- FortiGate-50B QuickStart Guide
- Fortinet Tools and Documentation CD

Figure 2: FortiGate-50B package contents

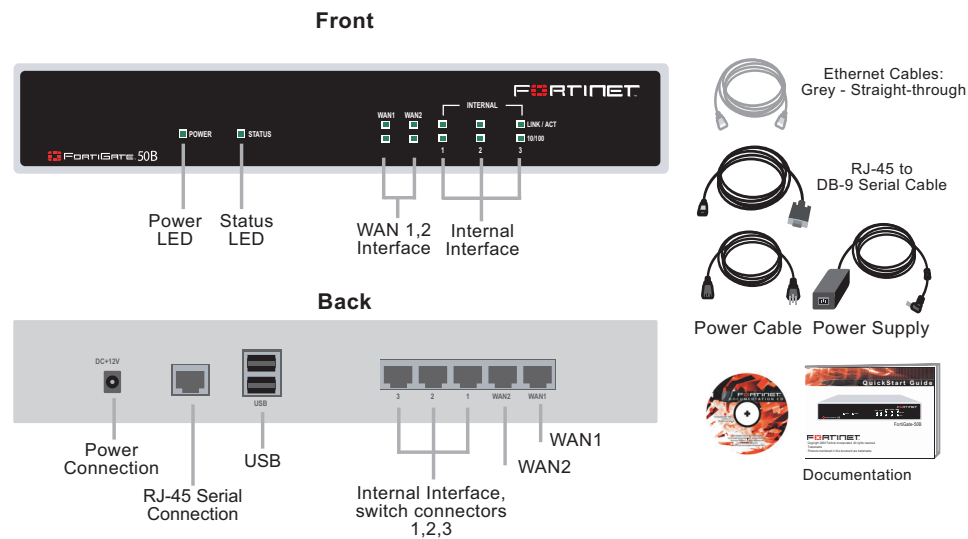

Table 2: Technical Specifications

Dimensions	8.5 x 1.4 x 5.8in. (21.6 x 14.8 x 3.6 cm)
Weight	1.6 lb. (0.73 kg)
Power Requirements	DC input voltage: 12V DC input current: 3A
Environmental Specifications	Operating temperature: 32 to 104 F (0 to 40 C) Storage temperature: -13 to 158 F (-25 to 70 C) Humidity: 5 to 95% non-condensing

FortiWiFi-50B

The FortiWiFi-50B package contains the following items:

- FortiWiFi-50B Unified Threat Management System
- one gray straight-through Ethernet cable (Fortinet part number CC300249)
- one RJ-45 to DB-9 serial cable (Fortinet part number CC300247)
- one AC adapter and power cable
- two mounting brackets
- FortiWiFi-50B QuickStart Guide
- Fortinet Tools and Documentation CD

Figure 3: FortiWiFi-50B package contents

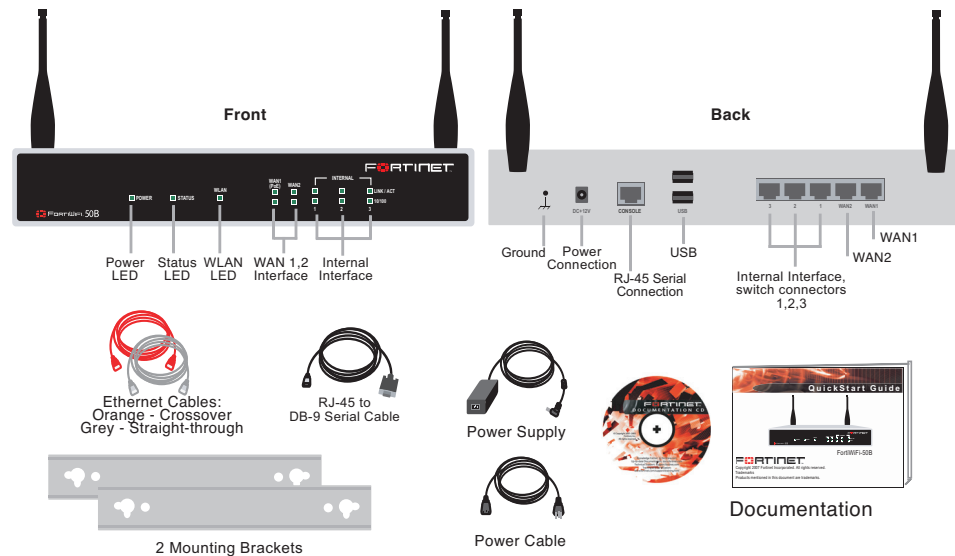

Table 3: Technical Specifications

Dimensions	8.5 x 1.4 x 5.8in. (21.6 x 14.8 x 3.6 cm)
Weight	1.6 lb. (0.73 kg)
Power Requirements	DC input voltage: 12V DC input current: 3A
Environmental Specifications	Operating temperature: 32 to 104 F (0 to 40 C) Storage temperature: -13 to 158 F (-25 to 70 C) Humidity: 5 to 95% non-condensing

FortiGate-100

The FortiGate-100 package contains the following items:

- FortiGate-100 Unified Threat Management System
- one orange crossover Ethernet cable (Fortinet part number CC300248)
- one gray straight-through Ethernet cable (Fortinet part number CC300249)
- one null-modem cable
- one AC adapter and power cable
- FortiGate-100 QuickStart Guide
- Fortinet Tools and Documentation CD

Figure 4: FortiGate-100 package contents

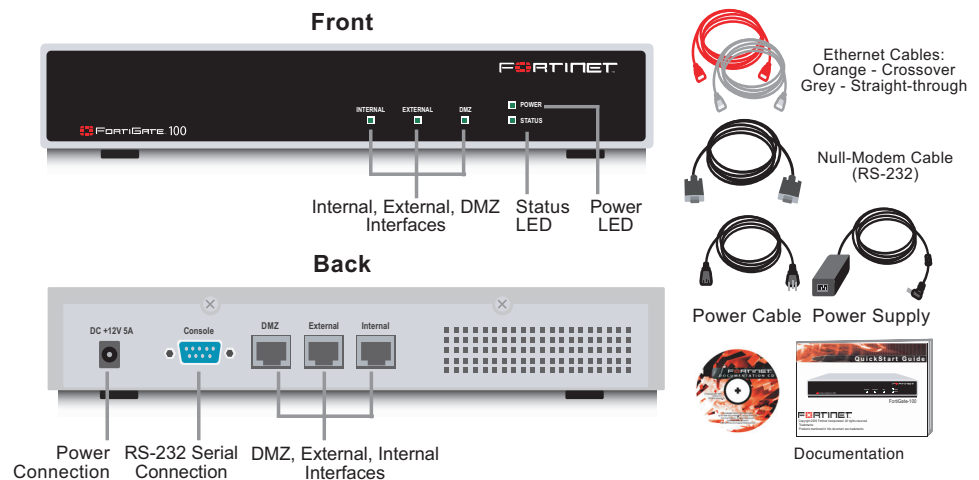

Table 4: Technical Specifications

Dimensions	10.25 x 6.13 x 1.75 in. (26 x 15.6 x 345 cm)
Weight	1.75 lb. (0.8 kg)
Power Requirements	DC input voltage: 12V DC input current: 5A
Environmental Specifications	Operating temperature: 32 to 104 F (0 to 40 C) Storage temperature: -13 to 158 F (-25 to 70 C) Humidity: 5 to 95% non-condensing

Warnings

This device complies with part 15 of the FCC Rules. Operation is subject to the following two conditions:

- (1) This device may not cause harmful interference, and
- (2) This device must accept any interference received, including interference that may cause undesired operation.

This equipment has been tested and found to comply with the limits for a Class B digital device, pursuant to part 15 of the FCC Rules. These limits are designed to provide reasonable protection against harmful interference in a residential installation. This equipment generates, uses and can radiate radio frequency energy and, if not installed and used in accordance with the instructions, may cause harmful interference to radio communications. However, there is no guarantee that interference will not occur in a particular installation. If this equipment does cause harmful interference to radio or television reception, which can be determined by turning the equipment off and on, the user is encouraged to try to correct the interference by one or more of the following measures:

- Reorient or relocate the receiving antenna.
- Increase the separation between the equipment and receiver.
- Connect the equipment into an outlet on a circuit different from that to which the receiver is connected.
- Consult the dealer or an experienced radio/TV technician for help.

The equipment compliance with FCC radiation exposure limit set forth for uncontrolled Environment.

Mounting

Adhere the rubber feet included in the package to the underside of the FortiWiFi unit, near the corners of the device.

Place the FortiGate unit on any flat, stable surface. Ensure the unit has at least 1.5 inches (3.75 cm) of clearance on each side to ensure adequate airflow for cooling.

Alternatively, you can use the mounting brackets to mount the FortiWiFi-50B to a wall. To attach the mounting brackets, place the bracket so that the flat portion is away from the FortiWiFi, and the bracket is supported by the bracket side bars. Use the four screws supplied to attach the bracket to the FortiWiFi unit. Repeat for the other bracket. See the illustration below for how the bracket is attached.

Figure 5: FortiWiFi with attached mounting bracket



To mount to the wall, measure where the holes in the brackets are on the wall, and insert nails or screws. Hang the FortiWiFi on the nails or screws from the brackets.

Powering on the FortiGate unit

The FortiGate unit does not have an on/off switch.

To power on the FortiGate unit

- 1 Connect the AC adapter to the power connection at the back of the FortiGate unit.
- 2 Connect the AC adapter to the power cable.
- 3 Connect the power cable to a power outlet.

The FortiGate unit starts and the Power and Status LEDs light up. The Status LED flashes while the FortiGate unit starts up.

Table 5: FortiGate-50A and FortiGate-100 LED indicators

LED	State	Description
Power	Green	The FortiGate unit is powered on.
	Off	The FortiGate unit is powered off.
Status	Flashing	The FortiGate unit is starting up.
	Off	The FortiGate unit is running normally.
Internal External DMZ (FortiGate-100)	Green	The correct cable is in use, and the connected equipment has power.
	Flashing green	Network activity at this interface.
	Off	No link established.
Internal External DMZ (FortiGate-100) interfaces (back)	Green	The correct cable is in use, and the connected equipment has power.
	Flashing amber	Network activity at this interface.
	Off	No link established.

Table 6: FortiGate-50B and FortiWiFi-50B LED indicators

LED	State	Description
Power	Green	The FortiGate unit is powered on.
	Off	The FortiGate unit is powered off.
Status	Flashing	The FortiGate unit is starting up.
	Off	The FortiGate unit is running normally.
WLAN (WiFi-50B)	Green	Wireless port is up.
	Off	Wireless port is down.
Link/Activity	Green	The correct cable is in use, and the connected equipment has power.
	Flashing green	Network activity at this interface.
	Off	No link established.
10/100	Green	The interface is connected at 100 Mbps.

Power over Ethernet

Power over Ethernet (PoE) is a method of powering Ethernet capable devices using CAT5 Ethernet cable to carry both data and power to a device, eliminating the need for a standard power source.

The FortiWiFi-50B includes the availability for PoE through the WAN1 port. The FortiWiFi-50B supports the IEEE 802.3af standard as a Powered Device (PD) using CAT5 Ethernet cable.

This enables you to place the FortiWiFi-50B in locations where connecting to a standard power source is inconvenient or impractical.



Caution: Attach a grounding cable to the Ground input in the FortiWiFi-50B and connect to a grounding source to avoid potential damage to the device in the event of a power surge.

Powering off the FortiGate unit

Always shut down the FortiGate operating system properly before turning off the power switch to avoid potential hardware problems.

To power off the FortiGate unit

- 1 From the web-based manager, go to **System > Status**.
- 2 In the Unit Operation display, select Shutdown, or from the CLI, enter:

```
execute shutdown
```
- 3 Disconnect the power supply.

Connecting to the FortiGate unit

There are two methods of connecting and configuring the basic FortiGate settings:

- the web-based manager
- the command line interface (CLI)

Web-based manager

You can configure and manage the FortiGate unit using HTTP or a secure HTTPS connection from any computer running Microsoft Internet Explorer or recent browser. The web-based manager supports multiple languages.

Use the web-based manager to configure most FortiGate settings, and monitor the status of the FortiGate unit.

Command line interface

You can access the FortiGate command line interface (CLI) by connecting a management computer serial port to the FortiGate serial console connector. You can also use Telnet or a secure SSH connection to the CLI from any network that is connected to the FortiGate unit, including the Internet.

Connecting to the web-based manager

Use the following procedure to connect to the web-based manager for the first time. Configuration changes made with the web-based manager are effective immediately, without resetting the firewall or interrupting service.

To connect to the web-based manager, you require:

- a computer with an Ethernet connection
- Microsoft Internet Explorer version 6.0 or higher or any recent version of most popular web browser
- a crossover Ethernet cable or an Ethernet hub with two Ethernet cables



Note: Before starting Internet Explorer, (or any recent version of the most popular web browser), ping to your FortiGate unit to see if the connection between the computer and the FortiGate unit is working properly.

To connect to the web-based manager

- 1 Set the IP address of the computer with an Ethernet connection to the static IP address 192.168.1.2 with a netmask of 255.255.255.0.



You can also configure the management computer to obtain an IP address automatically using DHCP. The FortiGate DHCP server assigns the management computer an IP address in the range 192.168.1.1 to 192.168.1.254.

- 2 Using the crossover cable or the Ethernet hub and cables, connect the internal interface of the FortiGate unit to the computer Ethernet connection.
- 3 Start Internet Explorer and browse to the address <https://192.168.1.99>. (remember to include the “s” in https://).

To support a secure HTTPS authentication method, the FortiGate unit ships with a self-signed security certificate, which is offered to remote clients whenever they initiate a HTTPS connection to the FortiGate unit. When you connect, the FortiGate unit displays two security warnings in the browser.

The first warning prompts you to accept and optionally install the FortiGate unit's self-signed security certificate. If you do not accept the certificate, the FortiGate unit refuses the connection. If you accept the certificate, the FortiGate login page appears. The credentials entered are encrypted before they are sent to the FortiGate unit. If you choose to accept the certificate permanently, the warning is not displayed again.

Just before the FortiGate login page is displayed, a second warning informs you that the FortiGate certificate distinguished name differs from the original request. This warning occurs because the FortiGate unit redirects the connection. This is an informational message. Select OK to continue logging in.

Figure 6: FortiGate login

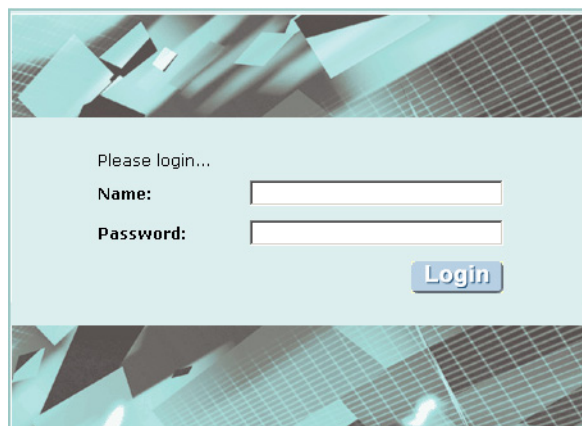

- 4 Type `admin` in the Name field and select Login.

After logging into the web-based manager, the web browser displays the system dashboard. The dashboard provides you with all system status information in one location. For details on the information displayed on the dashboard, see the [FortiGate Administration Guide](#).

Command line interface

You can access the FortiGate command line interface (CLI) by connecting a management computer serial port to the FortiGate serial console connector. You can also use Telnet or a secure SSH connection to connect to the CLI from any network that is connected to the FortiGate unit, including the Internet.

The CLI supports the same configuration and monitoring functionality as the web-based manager. In addition, you can use the CLI for advanced configuration options that are not available from the web-based manager. This guide contains information about basic and advanced CLI commands. For a more complete description about connecting to and using the FortiGate CLI, see the [FortiGate CLI Reference](#).

Connecting to the CLI

As an alternative to the web-based manager, you can install and configure the FortiGate unit using the CLI. Configuration changes made with the CLI are effective immediately, without resetting the firewall or interrupting service.

To connect to the FortiGate CLI you require:

- a computer with an available communications port
- the RJ-45 to DB-9 serial cable or null-modem cable included in your FortiGate package.
- terminal emulation software such as HyperTerminal for Microsoft Windows.



Note: The following procedure uses Microsoft Windows HyperTerminal software. You can apply these steps to any terminal emulation program.

To connect to the CLI

- 1 Connect the RJ-45 to DB-9 serial cable or null-modem cable to the communications port of your computer and to the FortiGate Console port.
- 2 Start HyperTerminal, enter a name for the connection and select OK.
- 3 Configure HyperTerminal to connect directly to the communications port on your computer and select OK.
- 4 Select the following port settings and select OK.

Bits per second	9600
Data bits	8
Parity	None
Stop bits	1
Flow control	None

- 5 Press Enter to connect to the FortiGate CLI.
The login prompt appears.
- 6 Type `admin` and press Enter twice.
The following prompt is displayed:

Welcome!

Type `?` to list available commands. For information about how to use the CLI, see the [FortiGate CLI Reference](#).

Quick installation using factory defaults



You can quickly set up your FortiGate unit for a home or small office using the web-based manager and the factory default FortiGate configuration. All you need to do is set your network computers to obtain an IP address automatically and to obtain DNS server IP addresses automatically (using DHCP), access the web-based manager, and configure the required settings for the FortiGate external interface. You can also configure FortiGate DNS servers and add a FortiGate default route if needed.

The FortiGate internal interface acts as a DHCP server for the internal network, automatically assigning IP addresses to computers (up to 100 computers) in the range of 192.168.1.110 –192.168.1.210.

Figure 7: Quick configuration using default settings

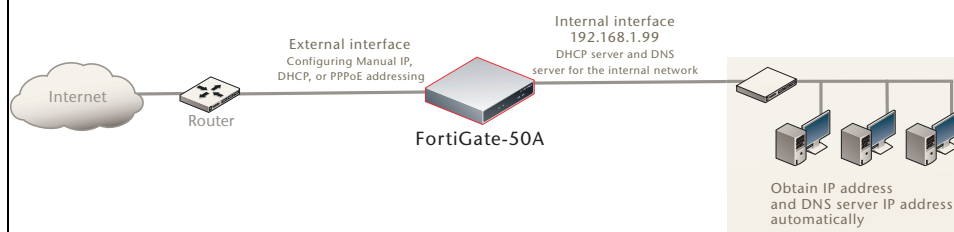

The FortiGate DHCP server also assigns the DNS server IP address 192.168.1.99 to each computer on the internal network. As a result, the FortiGate unit internal interface acts as a DNS server for the internal network. Using DNS forwarding, the FortiGate unit forwards DNS requests received from the internal network to the DNS server IP addresses added to the FortiGate unit configuration and returns lookup results to the internal network.

For more information about default DHCP server settings see [“Factory default DHCP server configuration”](#) on page 28.

The following procedure describes how to configure your internal network and the FortiGate unit to use the FortiGate default settings.

- 1 Connect the FortiGate unit between the internal network and the Internet and turn on the power.
- 2 Set the TCP/IP properties of the network computers to obtain an IP address automatically and a DNS server IP address automatically (using DHCP).
- 3 From the management computer, browse to <https://192.168.1.99>.
- 4 Go to **System > Network > Interface** and select Edit for the External or WAN1 interface.
- 5 Select one of the following Addressing modes
 - Manual: enter a static IP address and netmask, select OK, and go to step 6
 - DHCP: to get an IP address from the Internet Service Provider (ISP) select DHCP and go to step 9
 - PPPoE: to get an IP address from the ISP select PPPoE and go to step 9

- 6 Go to **System > Network > Options**.
- 7 Select one of the following DNS settings
 - Obtain DNS server address automatically: select to get the DNS addresses from the ISP, select Apply
 - Use the following DNS server addresses: select and enter the DNS server addresses given to you by the ISP, select Apply
- 8 Go to **Router > Static**, edit route #1 and change Gateway to the default gateway IP address from the ISP and select OK.
Network configuration is complete. Proceed to [“Next steps” on page 46](#).
- 9 Select Retrieve default gateway from server and Override internal DNS options if your ISP supports them, select OK, and proceed to [“Next steps” on page 46](#).
Go to step 6 if you are not selecting these options.



Factory defaults

The FortiGate unit ships with a factory default configuration. The default configuration enables you to connect to and use the FortiGate web-based manager to configure the FortiGate unit onto the network. To configure the FortiGate unit, you add an administrator password, change network interface IP addresses, add DNS server IP addresses, and, if required, configure basic routing.

If you plan to operate the FortiGate unit in Transparent mode, you can switch to Transparent mode from the factory default configuration and then configure the FortiGate unit onto the network.

Once you complete the network configuration, you can perform additional configuration tasks such as setting system time, configuring virus and attack definition updates, and registering the FortiGate unit.

The factory default firewall configuration includes a single network address translation (NAT) policy that allows users on your internal network to connect to the external network, and stops users on the external network from connecting to the internal network. You can add more firewall policies to provide more control of the network traffic passing through the FortiGate unit.

You can use the factory default protection profiles to apply different levels of antivirus protection, web content filtering, spam filtering, and IPS to the network traffic that is controlled by firewall policies.

This section includes the following topics:

- [Factory default DHCP server configuration](#)
- [Factory default NAT/Route mode network configuration](#)
- [Factory default Transparent mode network configuration](#)
- [Factory default firewall configuration](#)
- [Factory default protection profiles](#)
- [Restoring the default settings](#)

Factory default DHCP server configuration



With the FortiGate-50 series, you can quickly configure the internal network and the FortiGate unit by using the factory default DHCP server settings. See [“Quick installation using factory defaults” on page 24](#)

Table 7: FortiGate DHCP Server default configuration

Name	internal_dhcp_server
Interface	Internal
Default Gateway	192.168.1.99
IP Range	192.168.1.110 – 192.168.1.210
Network Mask	255.255.255.0
Lease Time	7 days
DNS Server 1	192.168.1.99

Factory default NAT/Route mode network configuration

When the FortiGate unit is first powered on, it is running in NAT/Route mode and has the basic network configuration listed in [Table 8 on page 28](#). This configuration enables you to connect to the FortiGate unit web-based manager and establish the configuration required to connect the FortiGate unit to the network. In [Table 8 on page 28](#), HTTPS administrative access means you can connect to the web-based manager using HTTPS protocol through this interface. Ping administrative access means this interface responds to ping requests.

Table 8: Factory default NAT/Route mode network configuration

Administrator account	User name: Password:	admin (none)
Internal interface	IP: Netmask: Administrative Access:	192.168.1.99 255.255.255.0 HTTP, HTTPS, Ping
External interface (FortiGate-50A/100) WAN1 (FortiGate-50B/WiFi-50B)	IP: Netmask: Administrative Access:	192.168.100.99 255.255.255.0 Ping
WAN2 (FortiGate-50B/WiFi-50B)	IP: Netmask: Administrative Access:	192.168.101.99 255.255.255.0 Ping
DMZ interface (FortiGate-50A/100)	IP: Netmask: Administrative Access:	10.10.10.1 255.255.255.0 HTTPS, Ping
WLAN interface (FortiWiFi-50B)	IP: Netmask: Administrative Access:	10.10.80.1 255.255.255.0 Ping

Table 8: Factory default NAT/Route mode network configuration (Continued)

Network Settings	Default Gateway (for default route)	192.168.100.1
	Interface connected to external network (for default route)	external
	Default Route A default route consists of a default gateway and the name of the interface connected to the external network (usually the Internet). The default gateway directs all non-local traffic to this interface and to the external network.	
	Primary DNS Server	65.39.139.53
	Secondary DNS Server	65.39.139.63

Factory default Transparent mode network configuration

In Transparent mode, the FortiGate unit has the default network configuration listed in [Table 9](#).

Table 9: Factory default Transparent mode network configuration

Administrator account	User name:	admin
	Password:	(none)
Management IP	IP:	0.0.0.0
	Netmask:	0.0.0.0
DNS	Primary DNS Server:	65.39.139.53
	Secondary DNS Server:	65.39.139.63
Administrative access	Internal	HTTPS, Ping
	External	Ping
	DMZ	HTTPS, Ping

Factory default firewall configuration

FortiGate firewall policies control how all traffic is processed by the FortiGate unit. Until firewall policies are added, no traffic can pass through the FortiGate unit. The factory default configuration contains one firewall policies to allows all traffic through the FortiGate unit. To allow specific traffic through the FortiGate unit, you can add firewall policies. See the [FortiGate Administration Guide](#) for information about adding firewall policies.

The following firewall configuration settings are included in the default firewall configuration to make it easier to add firewall policies.

Table 10: Factory default firewall configuration

Configuration setting	Name	Description
Firewall policy	Internal -> External	Source: All Destination: All
Firewall address	All	Firewall address matches the source or destination address of any packet.
Pre-defined service	More than 50 predefined services	Select from any of the 50 pre-defined services to control traffic through the FortiGate unit that uses that service.
Recurring schedule	Always	The recurring schedule is valid at any time.
Protection Profiles	Strict, Scan, Web, Unfiltered	Control how the FortiGate unit applies virus scanning, web content filtering, spam filtering, and IPS.

The factory default firewall configuration is the same in NAT/Route mode and Transparent mode.

Factory default protection profiles

Use protection profiles to apply different protection settings for traffic controlled by firewall policies. You can use protection profiles to:

- configure antivirus protection for HTTP, FTP, IMAP, POP3, and SMTP firewall policies
- configure Web filtering for HTTP firewall policies
- configure Web category filtering for HTTP firewall policies
- configure spam filtering for IMAP, POP3, and SMTP firewall policies
- enable the Intrusion Protection System (IPS) for all services
- enable content logging for HTTP, FTP, IMAP, POP3, and SMTP firewall policies

By using protection profiles, you can build protection configurations that can be applied to different types of firewall policies. This allows you to customize types and levels of protection for different firewall policies.

For example, while traffic between internal and external addresses might need strict protection, traffic between trusted internal addresses might need moderate protection. You can configure firewall policies for different traffic services to use the same or different protection profiles.

You can add Protection profiles to NAT/Route mode and Transparent mode firewall policies. The FortiGate unit includes four protection profiles.

Strict	To apply maximum protection to HTTP, FTP, IMAP, POP3, and SMTP traffic. You may not use the strict protection profile under normal circumstances but it is available if you have problems with viruses and require maximum screening.
Scan	To apply antivirus scanning and file quarantining to HTTP, FTP, IMAP, POP3, and SMTP content traffic.
Web	To apply antivirus scanning and web content blocking to HTTP content traffic. You can add this protection profile to firewall policies that control HTTP traffic.
Unfiltered	To apply no scanning, blocking or IPS. Use if you do not want to apply content protection to content traffic. You can add this protection profile to firewall policies for connections between highly trusted or highly secure networks where content does not need to be protected.

Restoring the default settings

You can revert to the factory default settings if you change a network setting and are unable to recover from it.



Caution: This procedure deletes all changes you have made to the FortiGate configuration and reverses the system to its original configuration, including resetting interface addresses.

Restoring the default settings using the web-based manager

To reset the default settings

- 1 Go to **System > Status**.
- 2 In Unit Operation Display, select Reset.

Restoring the default settings using the CLI

To reset the default settings enter the following command:

```
execute factoryreset
```

Configuring the FortiGate unit

This section provides an overview of the operating modes of the FortiGate unit. Before beginning to configure the FortiGate unit, you need to plan how to integrate the unit into your network. Your configuration plan depends on the operating mode you select: NAT/Route mode or Transparent mode.

This section includes the following topics:

- [Planning the FortiGate configuration](#)
- [Preventing the public interface from responding to ping requests](#)
- [NAT/Route mode installation](#)
- [Transparent mode installation](#)
- [Next steps](#)

Planning the FortiGate configuration

Before you configure the FortiGate unit, you need to plan how to integrate the unit into the network. Among other things, you must decide whether you want the unit to be visible to the network, which firewall functions you want it to provide, and how you want it to control the traffic flowing between its interfaces.

Your configuration plan depends on the operating mode you select. You can also configure the FortiGate unit and the network it protects using the default settings.

NAT/Route mode

In NAT/Route mode, the FortiGate unit is visible to the network. Like a router, all its interfaces are on different subnets. The following interfaces are available in NAT/Route mode:

Table 11: NAT/Route mode network segments

FortiGate Unit	Internal Interface	External Interface	Other
FortiGate-50A	Internal	External	Modem
FortiGate-50B	Internal	WAN1	WAN2
FortiWiFi-50B	Internal	WAN1	WAN2
FortiGate-100A	Internal	External	DMZ

Modem is the interface for connecting an external modem to the FortiGate-50A. See [“Configuring the modem for the FortiGate-50A” on page 53](#).

You can add firewall policies to control whether communications through the FortiGate unit operating in NAT or Route mode. Firewall policies control the flow of traffic based on the source address, destination address, and service of each packet. In NAT mode, the FortiGate unit performs network address translation before it sends the packet to the destination network. In Route mode, there is no address translation.

You typically use NAT/Route mode when the FortiGate unit is operating as a gateway between private and public networks. In this configuration, you create NAT mode firewall policies to control traffic flowing between the internal, private network and the external, public network (usually the Internet).

Figure 8: Example NAT/Route mode network configuration for a FortiGate-50A.

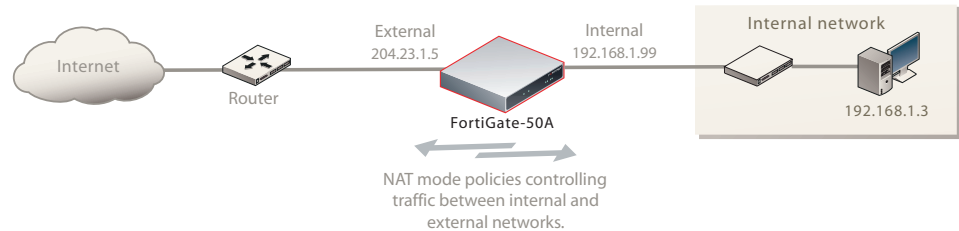

NAT/Route mode with multiple external network connections

In NAT/Route mode, you can configure the FortiGate unit with multiple redundant connections to the external network (usually the Internet).

For example, you could create the following configuration:

- External or WAN1 is the default interface to the external network (usually the Internet)
- Modem is the redundant interface to the external network for the FortiGate-50A
- WAN2 is the redundant interface to the external network on the FortiGate-50B and FortiWiFi-50B.
- DMZ is the redundant interface to the external network on the FortiGate-100
- Internal is the interface to the internal network

You must configure routing to support redundant Internet connections. Routing can automatically redirect connections from an interface if its connection to the external network fails.

Otherwise, security policy configuration is similar to a NAT/Route mode configuration with a single Internet connection. You would create NAT mode firewall policies to control traffic flowing between the internal, private network and the external, public network (usually the Internet).

Figure 9: NAT/Route multiple internet connection configuration for a FortiGate-50A

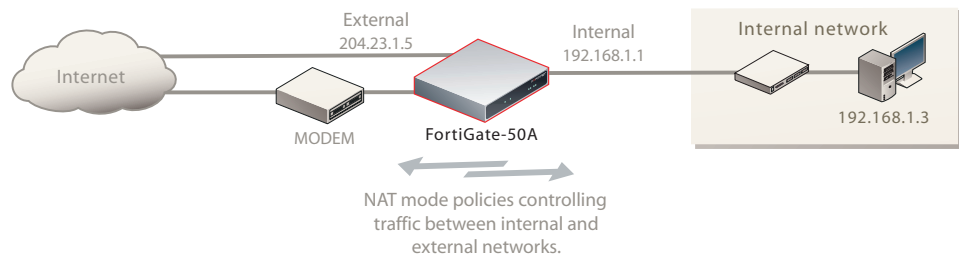

Transparent mode

In Transparent mode, the FortiGate unit is invisible to the network. Similar to a network bridge, all FortiGate interfaces must be on the same subnet. You only have to configure a management IP address so that you can make configuration changes. The management IP address is also used for antivirus and attack definition updates.

You typically use the FortiGate unit in Transparent mode on a private network behind an existing firewall or behind a router. The FortiGate unit performs firewall functions, IPSec VPN, virus scanning, IPS web content filtering, and Spam filtering.

Figure 10: Example Transparent mode network configuration for a FortiGate-100

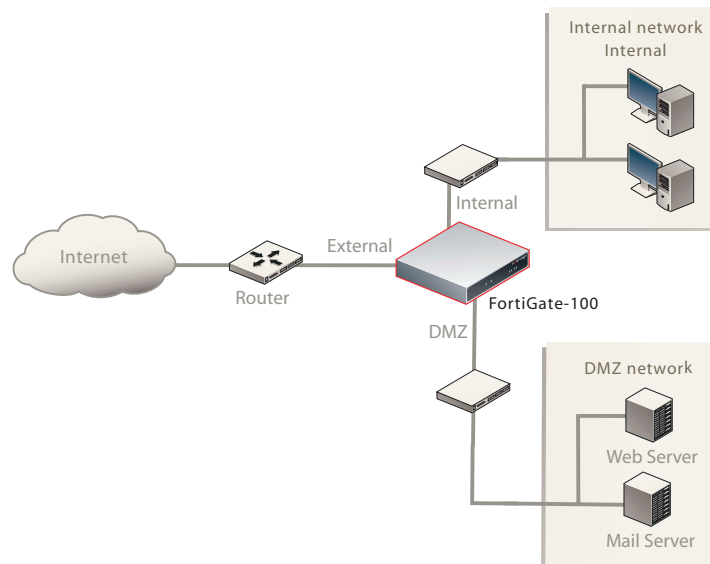

Preventing the public interface from responding to ping requests

The factory default configuration of your FortiGate unit allows the default public interface to respond to ping requests. The default public interface is also called the default external interface, and is the interface of the FortiGate unit that is usually connected to the Internet.

For the most secure operation, you should change the configuration of the external interface so that it does not respond to ping requests. Not responding to ping requests makes it more difficult for a potential attacker to detect your FortiGate unit from the Internet.

A FortiGate unit responds to ping requests if ping administrative access is enabled for that interface. You can use the following procedures to disable ping access for the external interface of a FortiGate unit. You can use the same procedure for any FortiGate interface. You can also use the same procedure in NAT/Route or Transparent mode.

To disable ping administrative access from the web-based manager

- 1 Log into the FortiGate web-based manager.
- 2 Go to **System > Network > Interface**.
- 3 Choose the external interface and select Edit.
- 4 Clear the Ping Administrative Access check box.
- 5 Select OK.

To disable ping administrative access from the FortiGate CLI

- 1 Log into the FortiGate CLI.
- 2 Disable administrative access to the external interface. Enter:

```
config system interface
  edit external
    unset allowaccess
  end
```

NAT/Route mode installation

This section describes how to install the FortiGate unit in NAT/Route mode. This section includes the following topics:

- [Preparing to configure the FortiGate unit in NAT/Route mode](#)
- [DHCP or PPPoE configuration](#)
- [Using the web-based manager](#)
- [Using the command line interface](#)
- [Connecting the FortiGate unit to the network\(s\)](#)
- [Configuring the networks](#)

Preparing to configure the FortiGate unit in NAT/Route mode

Use [Table 12 on page 36](#) to gather the information you need to customize NAT/Route mode settings.

You can configure the FortiGate unit in two ways:

- The web-based manager GUI is a complete interface for configuring most settings. See [“Using the web-based manager” on page 37](#).
- The command line interface (CLI) is a complete text-based interface for configuring all settings. See [“Using the command line interface” on page 39](#).

The method you choose depends on the complexity of the configuration, access and equipment, and the type of interface you are most comfortable using.

Table 12: NAT/Route mode settings

Administrator Password:		
Internal	IP:	____.____.____.____
	Netmask:	____.____.____.____
External/WAN1	IP:	____.____.____.____
	Netmask:	____.____.____.____
DMZ/WAN2	IP:	____.____.____.____
	Netmask:	____.____.____.____
Network settings	Default Gateway:	____.____.____.____
	(Interface connected to external network)	
	A default route consists of a default gateway and the name of the interface connected to the external network (usually the Internet). The default gateway directs all non-local traffic to this interface and to the external network.	
	Primary DNS Server:	____.____.____.____
	Secondary DNS Server:	____.____.____.____

DHCP or PPPoE configuration

You can configure any FortiGate interface to acquire its IP address from a DHCP or PPPoE server. Your Internet Service Provider (ISP) may provide IP addresses using one of these protocols.

To use the FortiGate DHCP server, you need to configure an IP address range and default route for the server. No configuration information is required for interfaces that are configured to use DHCP.

PPPoE requires you to supply a user name and password. In addition, PPPoE unnumbered configurations require you to supply an IP address. Use [Table 13](#) to record the information you require for your PPPoE configuration.

Table 13: PPPoE setting

User name:	
Password:	



Note: The FortiGate-50A includes default DHCP settings.

Using the web-based manager

You can use the web-based manager for the initial configuration of the FortiGate unit and all FortiGate unit settings. For information about connecting to the web-based manager, see [“Connecting to the web-based manager” on page 21](#).

Configuring basic settings

After connecting to the web-based manager, use the following procedures to complete the basic configuration of the FortiGate unit.

To add/change the administrator password

- 1 Go to **System > Admin > Administrators**.
- 2 Select the Change Password icon for the admin administrator.
- 3 Enter the new password and enter it again to confirm.
- 4 Select OK.

To configure interfaces

- 1 Go to **System > Network > Interface**.
- 2 Select the edit icon for an interface.
- 3 Set the addressing mode for the interface.
Choose from manual, DHCP, or PPPoE.
- 4 Complete the addressing configuration.
 - For manual addressing, enter the IP address and netmask for the interface.
 - For DHCP addressing, select DHCP and any required settings.
 - For PPPoE addressing, select PPPoE, and enter the username and password and any other required settings.

For information about how to configure these and other interface settings, see the FortiGate online help or the [FortiGate Administration Guide](#).

- 5 Select OK.
- 6 Repeat this procedure for each interface.



Note: If you change the IP address of the interface you are connecting to, you must connect through a web browser again using the new address. Browse to https:// followed by the new IP address of the interface. If the new IP address of the interface is on a different subnet, you may have to change the IP address of your computer to the same subnet.

To configure DNS server settings

- 1 Go to **System > Network > Options**.
- 2 Enter the IP address of the primary DNS server.
- 3 Enter the IP address of the secondary DNS server.
- 4 Select Apply.

Adding a default route

Add a default route to configure where the FortiGate unit sends traffic destined for an external network (usually the Internet). Adding the default route also defines which interface is connected to an external network. The default route is not required if the interface connected to the external network is configured using DHCP or PPPoE.

To add a default route

- 1 Go to **Router > Static**.
- 2 If the Static Route table contains a default route (IP and Mask set to 0.0.0.0), select the Delete icon to delete this route.
- 3 Select Create New.

- 4 Set Destination IP to 0.0.0.0.
- 5 Set Mask to 0.0.0.0.
- 6 Set Gateway to the default gateway IP address.
- 7 Set Device to the interface connected to the external network.
- 8 Select OK.

Verifying the web-based manager configuration

To verify access settings, go to the interface you want to verify and select the edit icon. The Administrative Access field should have check marks beside the settings you chose in the preceding steps.

Verify the connection

To verify your connection, try the following:

- browse to www.fortinet.com
- retrieve or send email from your email account

If you cannot browse to the web site or retrieve/send email from your account, review the previous steps to ensure all information was entered correctly and try again.

Using the command line interface

You can also configure the FortiGate unit using the command line interface (CLI). For information about connecting to the CLI, see [“Connecting to the CLI” on page 23](#).

Configuring the FortiGate unit to operate in NAT/Route mode

Use the information you gathered in [Table 12 on page 36](#) to complete the following procedures.

To add/change the administrator password

- 1 Log in to the CLI.
- 2 Change the admin administrator password. Enter:

```
config system admin
  edit admin
    set password <psswr>
  end
```

To configure interfaces

- 1 Log in to the CLI.
- 2 Set the IP address and netmask of the internal interface to the internal IP address and netmask you recorded in [Table 12 on page 36](#). Enter:

```

config system interface
  edit <interface>
    set mode static
    set ip <address_ip> <netmask>
  end

```

Example

```

config system interface
  edit internal
    set mode static
    set ip 192.168.120.99 255.255.255.0
  end

```

- 3** Set the IP address and netmask of the external interface to the external IP address and netmask you recorded in [Table 12 on page 36](#).

```

config system interface
  edit <interface>
    set mode static
    set ip <address_ip> <netmask>
  end

```

Example

```

config system interface
  edit external
    set mode static
    set ip 10.10.1.5 255.255.255.0
  end

```

To set the external interface to use DHCP, enter:

```

config system interface
  edit <interface>
    set mode dhcp
  end

```

To set the external interface to use PPPoE, enter:

```

config system interface
  edit <interface>
    set mode pppoe
    set connection enable
    set username <name_str>
    set password <psswr>
  end

```

- 4** Use the same syntax to set the IP address of each FortiGate interface as required.
- 5** Confirm that the addresses are correct. Enter:

```
get system interface
```

The CLI lists the IP address, netmask, and other settings for each of the FortiGate interfaces.

To configure DNS server settings

Set the primary and secondary DNS server IP addresses. Enter

```

config system dns
  set primary <address_ip>
  set secondary <address_ip>
end

```

Example

```

config system dns
  set primary 293.44.75.21
  set secondary 293.44.75.22
end

```

Adding a default route

Add a default route to configure where the FortiGate unit sends traffic that should be sent to an external network (usually the Internet). Adding the default route also defines which interface is connected to an external network. The default route is not required if the interface connected to the external network is configured using DHCP or PPPoE.

To add a default route

Set the default route to the Default Gateway IP address. Enter:

```

config router static
  edit <seq_num>
    set dst <class_ip&net_netmask>
    set gateway <gateway_IP>
    set device <interface>
  end

```



Example

If the default gateway IP is 10.10.1.2 and this gateway is connected to the external interface:

```

config router static
  edit 1
    set dst 0.0.0.0 0.0.0.0
    set gateway 10.10.1.2
    set device external
  end

```

Verify the connection

To verify the connection, try the following:

- ping the FortiGate unit
- browse to the web-based manager GUI
- retrieve or send email from your email account

If you cannot browse to the web site or retrieve/send email from your account, review the previous steps to ensure all information was entered correctly and try again.

You are now finished the initial configuration of the FortiGate unit.

Connecting the FortiGate unit to the network(s)

When you have completed the initial configuration, you can connect the FortiGate unit between your internal network and the Internet.

The following network connections are available on the FortiGate unit:

- Internal for connecting to your internal network
- External or WAN1 for connecting to the Internet



Modem is the interface for connecting an external modem to the FortiGate-50A. You can configure the modem interface as a redundant interface or stand alone interface to the Internet. For details on configuring the modem interface, see [“Configuring the modem for the FortiGate-50A” on page 53.](#)



DMZ for connecting to a DMZ network. You can also connect both the external and DMZ interfaces to different Internet connections to provide a redundant connection to the Internet.

To connect the FortiGate unit

- 1 Connect the Internal interface to the hub or switch connected to your internal network.
- 2 Connect the External or WAN1 interface to the Internet.
Connect to the public switch or router provided by your ISP. If you are a DSL or cable subscriber, connect the External interface to the internal or LAN connection of your DSL or cable modem.
- 3 Optionally connect the DMZ interface to your DMZ network.
You can use a DMZ network to provide access from the Internet to a web server or other server without installing the servers on your internal network.

Configuring the networks

If you are running the FortiGate unit in NAT/Route mode, your networks must be configured to route all Internet traffic to the IP address of the interface where the networks are connected.

- For the internal network, change the default gateway address of all computers and routers connected directly to your internal network to the IP address of the FortiGate internal interface.
- For the DMZ network, change the default gateway address of all computers and routers connected directly to your DMZ network to the IP address of the FortiGate DMZ interface.
- For the external network, route all packets to the FortiGate external interface.

If you are using the FortiGate unit as the DHCP server for your internal network, configure the computers on your internal network for DHCP.

Make sure the connected FortiGate unit is functioning properly by connecting to the Internet from a computer on the internal network. You should be able to connect to any Internet address.

Transparent mode installation

This section describes how to install the FortiGate unit in NAT/Route mode. This section includes the following topics:

- [Preparing to configure Transparent mode](#)
- [Using the web-based manager](#)
- [Using the command line interface](#)
- [Connecting the FortiGate unit to your network](#)

Preparing to configure Transparent mode

Use [Table 14](#) to gather the information you need to customize Transparent mode settings.

You can configure Transparent mode using one of the following methods:

- the web-based manager GUI
- the command line interface (CLI)

The method you choose depends on the complexity of the configuration, access and equipment, and the type of interface you are most comfortable using.

Table 14: Transparent mode settings

Administrator Password:		
Management IP	IP:	_____ . _____ . _____ . _____
	Netmask:	_____ . _____ . _____ . _____
	Default Gateway:	_____ . _____ . _____ . _____
The management IP address and netmask must be valid for the network from which you will manage the FortiGate unit. Add a default gateway if the FortiGate unit must connect to a router to reach the management computer.		
DNS Settings	Primary DNS Server:	_____ . _____ . _____ . _____
	Secondary DNS Server:	_____ . _____ . _____ . _____

Using the web-based manager

You can use the web-based manager to complete the initial configuration of the FortiGate unit. You can continue to use the web-based manager for all FortiGate unit settings.

For information about connecting to the web-based manager, see [“Connecting to the web-based manager” on page 21](#).

The first time you connect to the FortiGate unit, it is configured to run in NAT/Route mode.

To switch to Transparent mode using the web-based manager

- 1 Go to **System > Status**.
- 2 Select Change beside the Operation Mode.
- 3 Select Transparent in the Operation Mode list.
- 4 Type the Management IP/Netmask address and the Default Gateway address you gathered in [Table 14 on page 43](#).
- 5 Select Apply.

You do not have to reconnect to the web-based manager at this time. Once you select Apply, the changes are immediate, and you can go to the system dashboard to verify the FortiGate unit has changed to Transparent mode.

To configure DNS server settings

- 1 Go to **System > Network > Options**.
- 2 Enter the IP address of the primary DNS server.
- 3 Enter the IP address of the secondary DNS server.
- 4 Select Apply.

Using the command line interface

As an alternative to the web-based manager, you can begin the initial configuration of the FortiGate unit using the command line interface (CLI). To connect to the CLI, see [“Connecting to the CLI” on page 23](#). Use the information you gathered in [Table 14 on page 43](#) to complete the following procedures.

To change to Transparent mode using the CLI

- 1 Make sure you are logged into the CLI.
- 2 Switch to Transparent mode. Enter:

```
config system settings
    set opmode transparent
    set manageip <address_ip> <netmask>
    set gateway <address_ip>
end
```

After a few seconds, the following prompt appears:

```
Changing to TP mode
```

- 3 To confirm you have changed to transparent mode, enter the following:

```
get system status
```

The CLI displays the status of the FortiGate unit including the management IP address and netmask:

```
opmode           : transparent
manageip         : <address_ip> <netmask>
```

You should verify the DNS server settings are correct. The DNS settings carry over from NAT/Route mode and may not be correct for your specific Transparent mode configuration.

To verify the DNS server settings

Enter the following commands to verify the FortiGate unit's DNS server settings:

```
show system dns
```

The above command should give you the following DNS server setting information:

```
config system dns
    set primary 293.44.75.21
    set secondary 293.44.75.22
    set fwdirtf internal
end
```

To configure DNS server settings

Set the primary and secondary DNS server IP addresses. Enter:

```
config system dns
  set primary <address_ip>
  set secondary <address_ip>
end
```

Example

```
config system dns
  set primary 293.44.75.21
  set secondary 293.44.75.22
end
```

Reconnecting to the web-based manager

When the FortiGate unit has switched to Transparent mode, you can reconnect to the web-based manager using the new IP address. Browse to <https://> followed by the new IP address. If you connect to the management interface through a router, make sure you have added a default gateway for that route to the management IP default gateway field.

Connecting the FortiGate unit to your network

When you complete the initial configuration, you can connect the FortiGate unit between your internal network and the Internet, and optionally connect an additional network to the other interfaces if applicable.

To connect the FortiGate unit running in Transparent mode:

- 1 Connect the Internal interface to the hub or switch connected to your internal network.
- 2 Connect the External or WAN1 interface to network segment connected to the external firewall or router.
Connect to the public switch or router provided by your ISP.

Verify the connection

To verify the connection, try the following:

- ping the FortiGate unit
- browse to the web-based manager GUI
- retrieve or send email from your email account

If you cannot browse to the web site or retrieve/send email from your account, review the previous steps to ensure all information was entered correctly and try again.

Figure 11: FortiGate-50B Transparent mode connections

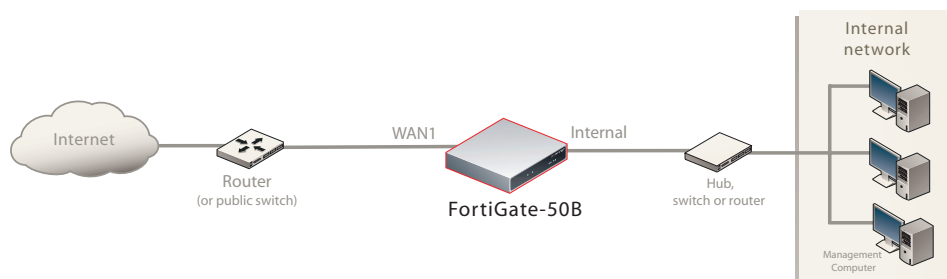

Next steps

Use the following information to configure FortiGate system time, and to configure antivirus and attack definition updates.

Refer to the [FortiGate Administration Guide](#) for complete information on configuring, monitoring, and maintaining your FortiGate unit.

Set the date and time

For effective scheduling and logging, the FortiGate system date and time must be accurate. You can either manually set the system date and time or configure the FortiGate unit to automatically keep its time correct by synchronizing with a Network Time Protocol (NTP) server.

To set the date and time

- 1 Go to **System > Status**.
- 2 Under **System Information > System Time**, select Change.
- 3 Select Refresh to display the current FortiGate system date and time.
- 4 Select your Time Zone from the list.
- 5 Optionally, select Automatically adjust clock for daylight saving changes check box.
- 6 Select Set Time and set the FortiGate system date and time.
- 7 Set the hour, minute, second, month, day, and year as required.
- 8 Select OK.



Note: If you choose the option Automatically adjust clock for daylight saving changes, the system time must be manually adjusted after daylight savings time ends.

To use NTP to set the FortiGate date and time

- 1 Go to **System > Status**.
- 2 Under **System Information > System Time**, select Change.
- 3 Select Synchronize with NTP Server to configure the FortiGate unit to use NTP to automatically set the system time and date.
- 4 Enter the IP address or domain name of the NTP server that the FortiGate unit can use to set its time and date.

- 5 Specify how often the FortiGate unit should synchronize its time with the NTP server.
- 6 Select OK.

Updating antivirus and IPS signatures

Configure the FortiGate unit to connect to the FortiGuard Distribution Network (FDN) to update the antivirus (including grayware), antispam and IPS attack definitions.

The FDN is a world wide network of FortiGuard Distribution Servers (FDS). When the FortiGate unit connects to the FDN, it connects to the nearest FDS. To do this, all FortiGate units are programmed with a list of FDS addresses sorted by nearest time zone according to the time zone configured for the FortiGate unit.

You can update your antivirus and IPS signatures using the web-based manager or the CLI. Before you can begin receiving updates, you must register your FortiGate unit from the Fortinet web page.



Note: Update AV and IPS signatures on a regular basis. If you do not update AV and IPS signatures regularly, the FortiGate unit can become vulnerable to new viruses.

After registering your FortiGate unit, verify the FortiGate unit can connect to the FDN:

- Check that the FortiGate unit's system time is correct.
- From the web-based manager, select refresh from the FortiGuard Center.

If you cannot connect to the FDN, follow the procedure for registering your FortiGate unit and try again or see [“Adding an override server” on page 49](#).

Updating antivirus and IPS signatures from the web-based manager

After you have registered your FortiGate unit, you can update antivirus and IPS signatures using the web-based manager. The FortiGuard Center enables you to receive push updates, allow push update to a specific IP address, and schedule updates for daily, weekly, or hourly intervals.

To update antivirus definitions and IPS signatures

- 1 Go to **System > Maintenance > FortiGuard Center**.
- 2 Select the blue arrow for AntiVirus and IPS Downloads to expand the options.
- 3 Select Update Now to update the antivirus definitions.

If the connection to the FDN is successful, the web-based manager displays a message similar to the following:

```
Your update request has been sent. Your database will
be updated in a few minutes. Please check your update
page for the status of the update.
```

After a few minutes, if an update is available, the System FortiGuard Center page lists new version information for antivirus definitions. The System Status page also displays new dates and version numbers for the antivirus definitions. Messages are recorded to the event log indicating whether the update was successful or not.



Note: Updating antivirus definitions can cause a very short disruption in traffic currently being scanned while the FortiGate unit applies the new signature database. Schedule updates when traffic is light, for example overnight, to minimize any disruption.

Updating the IPS signatures from the CLI

You can update IPS signatures using the CLI. Use the following procedure to update IPS signatures.



Note: You can only update antivirus definitions from the web-based manager.

To update IPS signatures using the CLI

- 1 Log into the CLI.
- 2 Enter the following CLI command:

```
configure system autoupdate ips
  set accept-recommended-settings enable
end
```

Scheduling antivirus and IPS updates

You can schedule regular, automatic updates of antivirus and IPS signatures, either from the web-based manager or the CLI.

To enable schedule updates from the web-based manager

- 1 Go to **System > Maintenance > FortiGuard Center**.
- 2 Select the Scheduled Update check box.
- 3 Select one of the following to check for and download updates

Every	Once every 1 to 23 hours. Select the number of hours and minutes between each update request.
Daily	Once a day. You can specify the time of day to check for updates.
Weekly	Once a week. You can specify the day of the week and time of day to check for updates.

- 4 Select Apply.

The FortiGate unit starts the next scheduled update according to the new update schedule.

Whenever the FortiGate unit runs a scheduled update, the event is recorded in the FortiGate event log.

To enable schedule updates from the CLI

- 1 Log into the CLI.
- 2 Enter the following command:

```
config system autoupdate schedule
  set frequency {every | daily | weekly}
  set status {enable | disable}
  set time <hh:mm>
end
```

Example

```
config system autoupdate schedule
    set update every Sunday
    set frequency weekly
    set status enable
    set time 16:45
end
```

Adding an override server

If you cannot connect to the FDN, or if your organization provides updates using their own FortiGuard server, use the following procedures to add the IP address of an override FortiGuard server in either the web-based manager or the CLI.

To add an override server from the web-based manager

- 1 Go to **System > Maintenance > FortiGuard Center**.
- 2 Select the blue arrow for AntiVirus and IPS Downloads to expand the options.
- 3 Select the Use override server address check box.
- 4 Type the fully qualified domain name or IP address of a FortiGuard server.
- 5 Select Apply.

The FortiGate unit tests the connection to the override server.

If the FDN setting changes to available, the FortiGate unit has successfully connected to the override server.

If the FDN stays set to not available, the FortiGate unit cannot connect to the override server. Check the FortiGate configuration and network configuration for settings that would prevent the FortiGate unit from connecting to the override FortiGuard server.

To add an override server using the CLI

- 1 Log into the CLI.
- 2 Enter the following command:

```
config system autoupdate override
    set address
    set status
end
```



Configuring the modem interface



The modem interface is only available on the FortiGate-50A.

The following sections will cover how to configure the FortiGate-50A modem using the CLI.

The FortiGate-50A supports a redundant or stand alone 56K modem interface in NAT/Route mode.

- In redundant mode, the modem interface automatically takes over from a selected Ethernet interface when that Ethernet interface is unavailable.
- In stand alone mode, the modem interface is the connection from the FortiGate unit to the Internet.

When connecting to an ISP in either configuration, the modem can automatically dial up to three dial-up accounts until the modem connects to an ISP.

This section includes the following topics:

- [Connecting a modem to the FortiGate-50A](#)
- [Selecting a modem mode](#)
- [Configuring the modem for the FortiGate-50A](#)
- [Adding a Ping Server](#)
- [Adding firewall policies for modem connections](#)

Connecting a modem to the FortiGate-50A

The FortiGate-50A can operate with most standard external serial interface modems that support standard Hayes AT commands. To connect, install a USB-to-serial converter between one of the two USB ports on the FortiGate unit and the serial port on the modem. The FortiGate unit does not support a direct USB connection between the two devices.

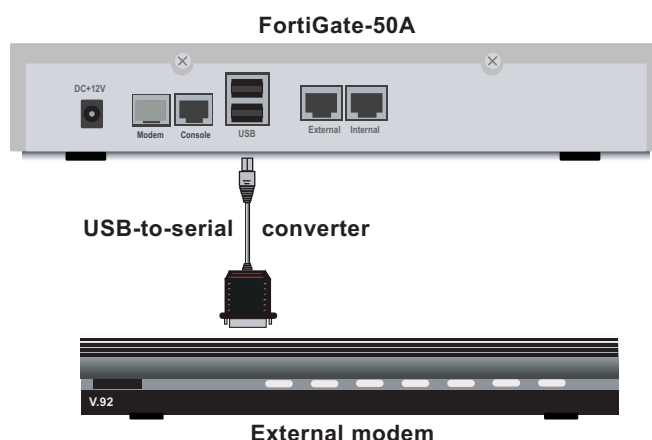
Figure 12: Example modem interface network connection

Selecting a modem mode

The modem interface can work in one of two modes:

- redundant mode
- stand alone mode

Redundant mode configuration

The redundant modem interface serves as a backup to the Ethernet interface. If that Ethernet interface disconnects from its network, the modem automatically dials the configured dial-up account(s). When the modem connects to a dial-up account, the FortiGate unit routes IP packets normally destined for the selected Ethernet interface to the modem interface. During this time, the unit pings the Ethernet connection to check when it is back online.

When the Ethernet interface can connect to its network again, the FortiGate unit disconnects the modem interface and switches back to the Ethernet interface.

For the FortiGate unit to switch from an Ethernet interface to the modem you must select the name of the interface in the modem configuration and configure a ping server for that interface. You must also configure firewall policies for connections between the modem interface and other FortiGate interfaces.

Stand alone mode configuration

In stand alone mode, you manually connect the modem to a dial-up account. The modem interface operates as the primary connection to the Internet. The FortiGate unit routes traffic through the modem interface, which remains permanently connected to the dial-up account.

If the connection to the dial-up account fails, the FortiGate unit modem automatically redials the number. The modem redials the ISP number based on the amount of times specified by the redial limit, or until it connects to a dial-up account.

In stand alone mode the modem interface replaces the external Ethernet interface. You must also configure firewall policies for connections between the modem interface and other FortiGate interfaces.

Configuring the modem for the FortiGate-50A

Configure the modem for the FortiGate-50A using the CLI. The following table of CLI commands are specifically for the FortiGate-50A modem configuration.

Table 15: CLI commands for the FortiGate-50A

Keywords and variables	Description	Default
altmode {enable disable}	Enable for installations using PPP in China.	enable
auto-dial {enable disable}	Enable to dial the modem automatically if the connection is lost, or the FortiGate unit is restarted. dial-on-demand must be disabled. mode must be standalone.	disable
connect_timeout <seconds>	Set the connection completion timeout (30-255 seconds).	90
dial-on-demand {enable disable}	Enable the FortiGate unit to dial the modem when packets are routed to the modem interface. The modem disconnects after it reaches the idle-timer period value if there is no traffic through the modem interface within that time. When traffic occurs on the interface, the FortiGate unit dials the modem again. auto-dial must be disabled when in standalone mode.	disable
holddown-timer <seconds>	Used only when the modem is configured as a backup for an interface. Set the time (1-50B seconds) that the FortiGate unit waits before switching from the modem interface to the primary interface, after the primary interface has been restored. mode must be redundant.	60
idle-timer <minutes>	Set the number of minutes the traffic through the modem connection is idle before it the FortiGate unit disconnects. mode must be standalone.	5
interface <name>	Enter an interface name to associate the modem interface with the Ethernet interface that you want to either back up (backup configuration) or replace (standalone configuration).	No default.
mode <mode>	Enter the required mode: • standalone The modem interface is the connection from the FortiGate unit to the Internet. • redundant The modem interface automatically takes over from a selected Ethernet interface when that Ethernet interface is unavailable.	standalone
passwd1 <password_srt>	Enter the password used to access the specified dialup account.	No default

passwd2 <password_str>	Enter the password used to access the specified dialup account.	No default.
passwd3 <password_str>	Enter the password used to access the specified dial-up account.	No default.

Table 15: CLI commands for the FortiGate-50A

peer_modem1 {actiontec ascendTNT generic}	If the modem at phone1 is Actiontec or AscendTNT, select that type, otherwise leave setting as generic. This setting applies to models 50AM, 60M, and WiFi-50BM only.	generic
peer_modem2 {actiontec ascendTNT generic}	If the modem at phone2 is Actiontec or AscendTNT, select that type, otherwise leave setting as generic. This setting applies to models 50AM, 60M, and WiFi-50BM only.	generic
peer_modem3 {actiontec ascendTNT generic}	If the modem at phone3 is Actiontec or AscendTNT, select that type, otherwise leave setting as generic. This setting applies to models 50AM, 60M, and WiFi-50BM only.	generic
phone1 <phone-number>	Enter the phone number required to connect to the dial-up account. Do not add spaces to the phone number. Make sure to include standard special characters for pauses, country codes, and other functions as required by your modem to connect to your dial-up account.	No default.
phone2 <phone-number>	Enter the phone number required to connect to the dialup account. Do not add spaces to the phone number. Make sure to include standard special characters for pauses, country codes, and other functions as required by your modem to connect to your dialup account.	No default.
phone3 <phone-number>	Enter the phone number required to connect to the dialup account. Do not add spaces to the phone number. Make sure to include standard special characters for pauses, country codes, and other functions as required by your modem to connect to your dialup account.	No default.
redial <tries_interger>	Set the maximum number of times (1-10) the FortiGate unit dials the ISP to restore an active connection on the modem interface. Select <i>none</i> to allow the modem to redial without a limit.	No default.
status {disable enable}	Enable or disable modem support.	disable
username1 <name_str>	Enter the user name used to access the specified dial-up account.	No default.
username2 <name_str>	Enter the user name used to access the specified dialup account.	No default.
username3 <name_str>	Enter the user name used to access the specified dialup account.	No default.

Example

```
config system modem
    set action dial
    set status enable
    set holddown-time 5
    set interface wan1
    set passwd1 acctlpasswd
    set phone1 1234567891
    set redial 10
    set username1 acctluser
end
```

Adding a Ping Server

Adding a ping server is required for routing failover for the modem in redundant mode. A ping server confirms the connectivity to an Ethernet interface. If the Ethernet interface fails, the ping server continually checks to see when the connection has been restored.

To add a ping server to an interface

- 1 Go to **System > Network > Interface**.
- 2 Choose an interface and select Edit.
- 3 Set Ping Server to the IP address of the next hop router on the network connected to the interface.
- 4 Select the Enable check box.
- 5 Select OK to save the changes.

Dead gateway detection

The FortiGate unit uses dead gateway detection to ping the Ping Server IP address to make sure the FortiGate unit can connect to this IP address.

Modify dead gateway detection to control how the FortiGate unit confirms connectivity with a ping server added to an interface configuration. For information about adding a ping server to an interface, above.

To modify the dead gateway detection settings

- 1 Go to **System > Network > Options**.
- 2 For Detection Interval, type a number in seconds to specify how often the FortiGate unit tests the connection to the ping target.
- 3 For Fail-over Detection, type a number of times that the connection test fails before the FortiGate unit assumes the gateway is no longer functioning.
- 4 Select Apply.

Adding firewall policies for modem connections

The modem interface requires firewall addresses and policies. You can add one or more addresses to the modem interface. For information about adding addresses, see the [FortiGate Administration Guide](#). When you add addresses, the modem interface appears on the policy grid.

You can configure firewall policies to control the flow of packets between the modem interface and the other interfaces on the FortiGate unit. For information about adding firewall policies, see the [FortiGate Administration Guide](#).

Using a wireless network



This chapter is specifically for the FortiWiFi-50B.

In a wired network, computers are connected through a series of cables that transfer information. In a wireless network, information is transferred over radio waves. There are factors which affect the transmission of data “on the air” that you must take into account when setting up a wireless network.

This section outlines the considerations for wireless networking and steps you can take to make your wireless network as efficient as possible.

This section includes the following topics:

- [Setting up a wireless network](#)
- [Wireless Security](#)
- [FortiWiFi-50B operation modes](#)
- [Setting up the FortiWiFi-50B as an Access Point](#)

Setting up a wireless network

In its simplest form, a wireless network is an Access Point communicating with one wireless device. An Access Point (AP) is a device that provides a communications hub for a wireless network. The AP and the wireless devices operate on a common radio channel. The FortiWiFi-50B acts as an AP and assigns all wireless users to the same subnet. With the proper firewall policies and routing, wireless users can communicate with users on the internal network or on an external network such as the Internet.

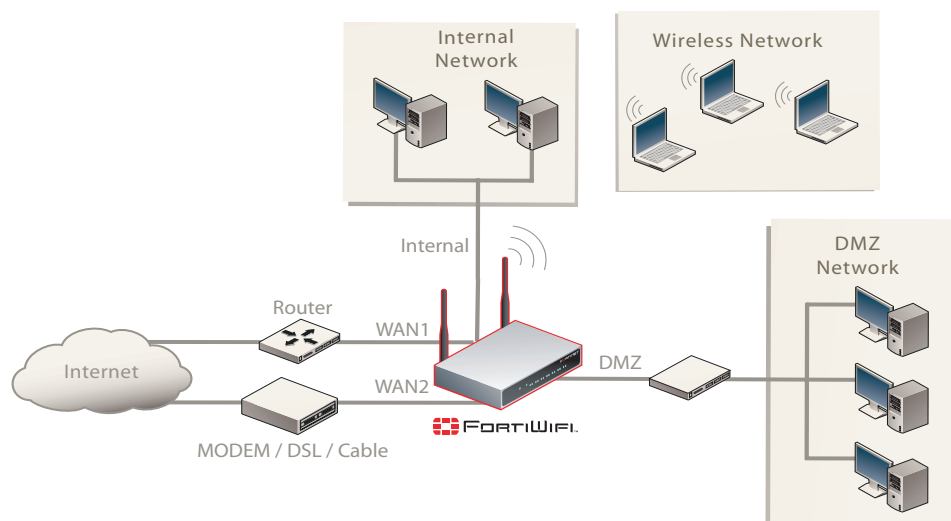
Figure 13: FortiWiFi-50B as an Access Point

Positioning an Access Point

When placing the FortiWiFi-50B AP, your main concern is providing a strong signal to all users. A strong signal ensures a fast connection and the efficient transfer of data. A weaker signal means a greater chance of data transmission errors and the need to re-send information, slowing down data transfer.

Consider the following guidelines when placing the FortiWiFi-50B AP:

- Physical barriers can impede the radio signals. Solid objects such as walls, furniture and people absorb radio waves, weakening the signal. Be aware of the physical barriers in your office space that may reduce a signal. If there is enough physical interference, you may encounter dead spots that receive no signals.
- Ensure the FortiWiFi-50B AP is located in a prominent location within a room for maximum coverage, rather than in a corner.
- Construction materials used in a building can also weaken radio signals. Rooms with walls of concrete or metal can affect the signal strength.

Radio Frequency interface

The 802.11 standard uses a frequency range of 2.4 to 2.483 GHz. Radio frequency (RF) interference occurs when other devices send RF signals during their normal operation that use the same frequency as the FortiWiFi-50B AP. Wireless devices such as 2.4 GHz cordless phones, microwave ovens and Bluetooth devices can interfere with packet transmissions on a wireless network.

To avoid RF interference:

- Remove these devices from the immediate area where users are working. Something as simple as a Bluetooth enabled mouse may cause transmission interruptions.
- Keep the FortiWiFi-50B AP and wireless devices at least 10 feet away from appliances such as microwave ovens and cordless phones.
- If you must have a cordless phone, select one that does not use the 2.4GHz frequency range.
- Consider more FortiWiFi-50B APs to help strengthen the signal. The weaker the signal, the slower the transmission will be as it tries to compete against other wireless devices.
- Set a channel that users and FortiWiFi-50B APs will specifically use can improve signal quality.

Using multiple access points

If you cannot avoid some of these impediments due to the shape of the office or building materials used, you may need to use multiple FortiWiFi-50B APs to help distribute the radio signal around the room. [Figure 14](#) shows how positioning two FortiWiFi-50B APs within a uniquely shaped office space helps to distribute signals around the area.

Figure 14: Using multiple APs to provide a constant strong signal.

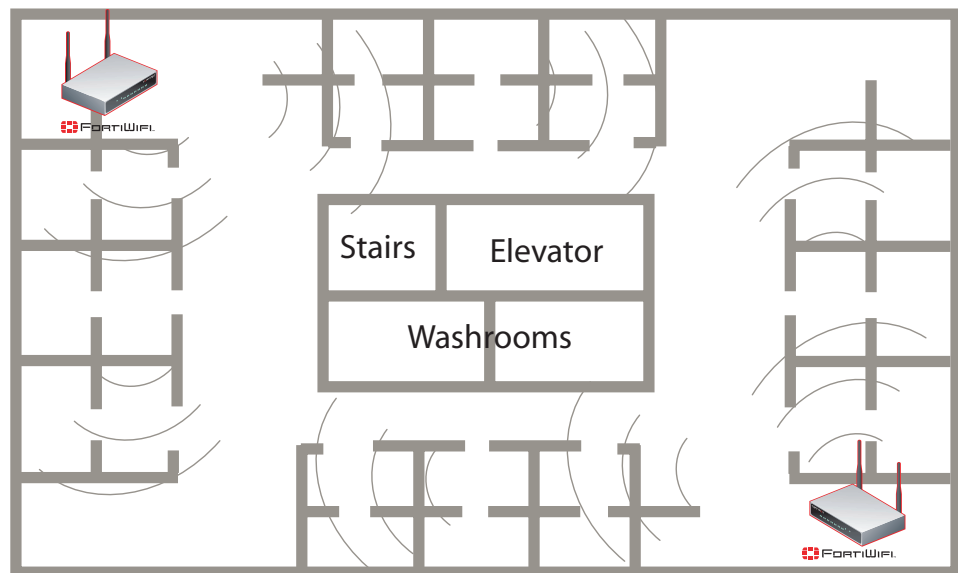

This sample office has washrooms, a stairwell and an elevator shaft in the center of the building, making it impossible to use a single FortiWiFi-50B AP effectively. The elevator shaft and multiple metal stalls in the washrooms can cause signal degradation. However, placing a FortiWiFi-50B AP in opposite corners of the office provides maximum coverage.

When using multiple APs, each FortiWiFi-50B AP should be set to a different channel to avoid interference in areas where signals from both FortiWiFi-50B devices can be received.

Wireless Security

Radio waves transmitted between a wireless device and access points provide the weakest link between the wireless device and network servers. Wireless networking can be risky because information travels on radio waves, which is a public medium. The 802.11 standard includes security options to stop your information from being intercepted by unwanted sources. These are Wireless Equivalent Privacy (WEP) and WiFi Protected Access (WPA) encryption. Wireless encryption is only used between the wireless device and the AP. The AP decrypts the data before sending it along the wired network. The FortiWiFi-50B supports both encryption methods.

Wireless Equivalent Privacy (WEP)

WEP security uses an encryption key between the wireless device and the AP. For WEP security, the wireless device and AP must use the same encryption key, and is manually typed by the wireless user and administrator. When activated, the wireless device encrypts the data with the encryption key for each frame using RSA RC4 ciphers.

There has been criticism of WEP security. WEP keys are static. They must be changed manually and frequently on both the wireless device and the APs. On a small company or network with a few users and APs, this is not a big issue. However, the more users and APs, changing WEP keys regularly can become an administrative headache and potentially error prone. Consequently, keys are rarely changed over months or years, leaving a hacker plenty of time to get the key and gain access to the network.

In small wireless networking environments, activating WEP security will significantly minimize outside infiltrators from getting in your network and is better than no security at all. However, it is still very important that you regularly change the WEP key, at least weekly; or monthly at most.

Wi-Fi Protected Access (WPA)

WPA was developed to replace the WEP standard and provide a higher level of data protection for wireless networks. WPA provides two methods of authentication; through 802.1X authentication or pre-shared keys.

802.1X authenticates users through an EAP authentication server such as a RADIUS server authenticates each user before they can connect to the network. The encryption keys can be changed at varying intervals to minimize the opportunity for hackers to crack the key being used.

In a network setup where a RADIUS server is not a viable option, WPA also provides authentication with preshared keys using Temporal Key Integrity Protocol (TKIP). Using TKIP, the encryption key is continuously re-keyed while the user is connected to the wireless network. This creates a unique key on every data packet. To further ensure data integrity, a Message Integrity Code (MIC also known as Michael) is incorporated into each packet. It uses an 8 byte message integrity code that is encrypted using the MAC addresses and data from each frame to provide a more secure packet transmission.

WPA provides a more robust security between the wireless device and the access point. The FortiWiFi-50B device supports both WPA methods.

Additional security measures

The FortiWiFi-50B includes other security measures you can use to block unwanted users from accessing your wireless network. By setting a few extra options, you can be assured your network and its information is secure.

MAC address filtering

To improve the security of your wireless network, consider enabling MAC address filtering on the FortiWiFi-50B unit. By enabling this feature, you define the wireless devices that can access the network based on their system MAC address. When a user attempts to access the wireless network, the FortiWiFi-60 unit checks the MAC address of the user to the list you created. If the MAC address is on the approved list, the user gains access to the network. If the user is not in the list, the user is rejected. Using MAC address filtering makes it more difficult for a hacker using random MAC addresses or spoofing a MAC address to gain access to your network.

Service Set Identifier

The Service Set Identifier (SSID) is the network name shared by all users on a wireless network. Wireless users should configure their computers to connect to the network that broadcasts this network name. For security reasons, do not leave the default name of "fortinet" as the network name.

Broadcasting enables wireless users to find a network. The FortiWiFi-50B models includes an option not to broadcast the SSID. This provides an extra layer of protection. If you configure all wireless users to the correct SSID, you do not need to enable the broadcasting of the SSID.

To disable SSID

- 1 Go to **System > Wireless > Settings**.
- 2 Select Disable for the SSID Broadcast.
- 3 Select OK.

FortiWiFi-50B operation modes

The FortiWiFi-50B models each have two modes of operation for wireless networking: Access Point and Client.

Access Point mode

When using the FortiWiFi in Access Point mode, the device acts as an access point for wireless users to connect to, send and receive information over a wireless network. It enables multiple wireless network users access to the network without the need to connect to it physically. The FortiWiFi-50B can connect to the internal network and act as a firewall to the Internet. Access Point mode is the default mode.

Figure 15: FortiWiFi in Access Point mode

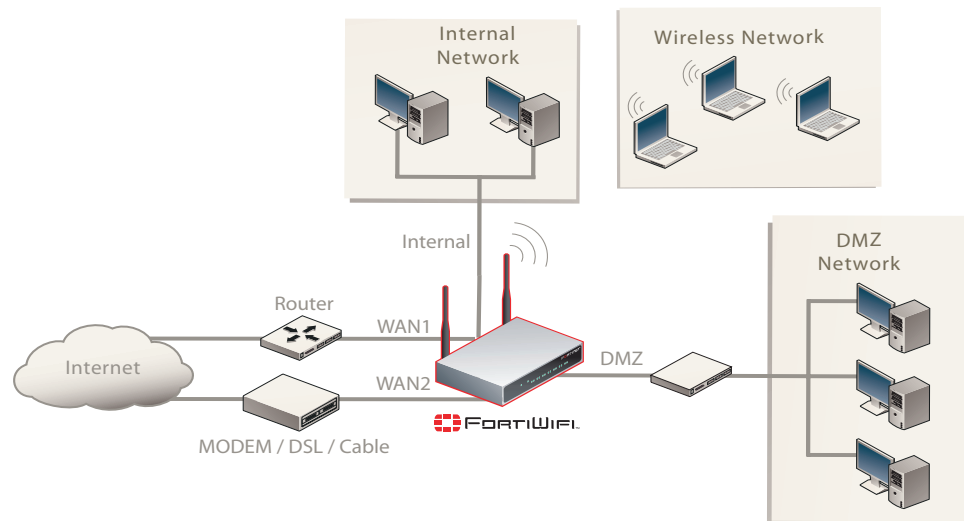

Client mode

When using the FortiWiFi-50B in Client mode, the device is set to receive transmissions from another access point. This enables you to connect remote users to an existing network using wireless protocols from a location that does not have a wired infrastructure.

For example, in a warehouse where shipping and receiving are on opposite sides of the building, running cables is not an option due to the warehouse environment. The FortiWiFi-50B unit can support wired users using its four Ethernet ports and can connect to another Access Point wirelessly as a Client. This connects the wired users to the network using the 802.11 wireless standard as a backbone.

Figure 16: FortiWiFi-50B in Client mode

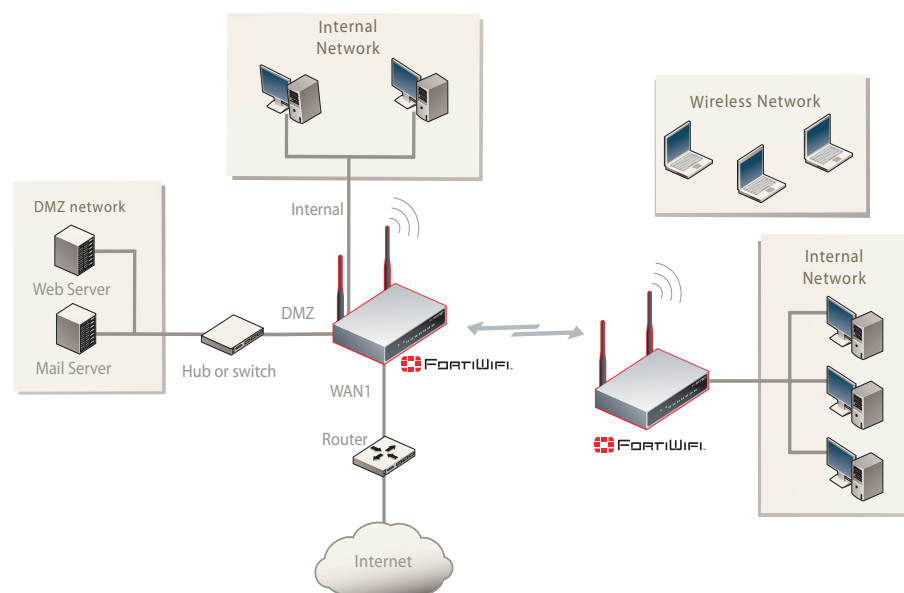

Changing the operating mode

To change the wireless operating mode

- 1 Go to **System > Wireless > Settings**.
- 2 For the Operation mode, select Change
- 3 Select the desired operation mode and select OK.

Setting up the FortiWiFi-50B as an Access Point

This section describes how to quickly configure the FortiWiFi-50B unit as an AP to allow network access for wireless workstations located on the same wireless LAN as the unit. It also describes how to configure firewall policies and wireless security features to provide a secure wireless environment. For initial setup, use a desktop computer on the internal network with TCP/IP set as a DHCP client

This section contains the following steps:

- [Set the DHCP settings](#)
- [Set the security options](#)
- [Configure the firewall policies](#)

Set the DHCP settings

Configure a DHCP server for the FortiWiFi-50B WLAN interface. As a DHCP server, the interface dynamically assigns IP addresses to hosts on the network connected to the WLAN interface.

To configure the FortiWiFi-50B to be a DHCP server

- 1 Go to **System > DHCP > Service**.
- 2 Select the blue triangle to expand the WLAN options.
- 3 Configure the DHCP server settings:

Name:	Enter a name of the DHCP sever. For example, DHCPSever_1.
Enable:	Select to enable the DHCP Server.
Type:	Select regular unless you are configuring for remote clients who will have an IPSec VPN connection to the WLAN interface.
IP Range:	Enter the IP address of the WLAN to configure the IP address range. For example, 10.10.80.1 to 10.10.80.20.
Network Mask:	Enter the network mask you created in Table 12 on page 36 .
Domain:	Enter domain name, for example, www.fortinet.com.
Lease Time:	The expiry date of an IP address. This feature specifies either an unlimited or limited timeframe of an IP address.
Advanced:	Use only to specify several DNS servers. This is the DNS that the wireless clients will use when accessing the Internet.
- 4 Select OK.



Note: The IP range must match the subnet address of the network where the DHCP request was received. Usually this would be the subnet connected to the WLAN interface.

Set the security options

To ensure proper security and protection of your network and its information, set the security options for the FortiWiFi-50B unit.

To set the data security

- 1 Go to **System > Wireless > Settings**.
- 2 Enter an SSID.
- 3 Set the SSID Broadcast to either enable or disable.
- 4 Select a Security mode.
- 5 Enter a key or pre-shared key depending on the Security Mode selected.
- 6 Select the MAC Filter tab.
- 7 Enable MAC filtering if desired.
- 8 Enter the MAC addresses and select to Allow or Deny.



Note: You will need to distribute the information entered in step 2 and step 5 with the wireless users so they can connect to the wireless network. It is highly recommended you do not select "None". Selecting None will leave your wireless network prone to hackers.

Configure the firewall policies

The FortiWiFi-50B provides WAN interfaces for Internet connections. You can configure the Internet connection for both wired networks and the wireless network through the WLAN interface.

You can provide secure Internet access for wireless clients by creating firewall policies from the WLAN interface to the WAN1 or WAN2 interfaces.

The following example creates a policy from the wireless clients (WLAN interface) to the Internet (WAN1 interface) using traffic shaping, firewall authentication and the default Strict content policy.

To create a new wall policy for a secure Internet connection

- 1 Go to **Firewall > Policy**.
- 2 Select the blue arrow for WLAN to WAN1.
- 3 Select Create New.
- 4 Configure the following settings and select OK:

Interface/Zone Source	WLAN
Interface/Zone Destination	WAN1
Address Name Source	All
Address Name Destination	All
Schedule	Always
Service	ANY
Action	ACCEPT
NAT	Enable
Protection Profile	Strict

FortiGate Firmware

Fortinet periodically updates the FortiGate firmware to include enhancements and address issues. After you have registered your FortiGate unit, FortiGate firmware is available for download at <http://support.fortinet.com>.

Only the FortiGate administrators (whose access profiles contain system configuration read and write privileges) and the FortiGate admin user can change the FortiGate firmware.

This section includes the following topics:

- [Upgrading to a new firmware version](#)
- [Reverting to a previous firmware version](#)
- [Installing firmware images from a system reboot using the CLI](#)
- [The FortiUSB key](#)
- [Testing a new firmware image before installing it](#)
- [Installing and using a backup firmware image \(FortiGate-100 only\)](#)



Note: If you have an earlier version of the FortiOS firmware, for example FortiOS v2.50, upgrade to FortiOS v2.80MR11 before upgrading to FortiOS v3.0.

Upgrading to a new firmware version

Use the web-based manager or CLI procedure to upgrade to a new FortiOS firmware version or to a more recent build of the same firmware version.

Upgrading the firmware using the web-based manager

Use the following procedures to upgrade the FortiGate unit to a new firmware version.



Note: Installing firmware replaces your current antivirus and attack definitions, along with the definitions included with the firmware release you are installing. After you install new firmware, make sure that antivirus and attack definitions are up to date. For details see the [FortiGate Administration Guide](#).



Note: To use this procedure, you must log in using the admin administrator account, or an administrator account that has system configuration read and write privileges.

To upgrade the firmware using the web-based manager

- 1 Copy the firmware image file to your management computer.
- 2 Log into the web-based manager as the admin administrative user.
- 3 Go to **System > Status**.
- 4 Under **System Information > Firmware Version**, select Update.

- 5 Type the path and filename of the firmware image file, or select Browse and locate the file.
- 6 Select OK.
The FortiGate unit uploads the firmware image file, upgrades to the new firmware version, restarts, and displays the FortiGate login. This process takes a few minutes.
- 7 Log into the web-based manager.
- 8 Go to **System > Status** and check the Firmware Version to confirm the firmware upgrade is successfully installed.
- 9 Update antivirus and attack definitions. For information about updating antivirus and attack definitions, see the [FortiGate Administration Guide](#).

Upgrading the firmware using the CLI

To use the following procedure, you must have a TFTP server the FortiGate unit can connect to.



Note: Installing firmware replaces your current antivirus and attack definitions, along with the definitions included with the firmware release you are installing. After you install new firmware, use the procedure make sure that antivirus and attack definitions are up to date. You can also use the CLI command `execute update-now` to update the antivirus and attack definitions. For details, see the [FortiGate Administration Guide](#).



Note: To use this procedure, you must log in using the admin administrator account, or an administrator account that has system configuration read and write privileges.

To upgrade the firmware using the CLI

- 1 Make sure the TFTP server is running.
- 2 Copy the new firmware image file to the root directory of the TFTP server.
- 3 Log into the CLI.
- 4 Make sure the FortiGate unit can connect to the TFTP server.

You can use the following command to ping the computer running the TFTP server. For example, if the IP address of the TFTP server is 192.168.1.168:

```
execute ping 192.168.1.168
```

- 5 Enter the following command to copy the firmware image from the TFTP server to the FortiGate unit:

```
execute restore image <name_str> <tftp_ipv4>
```

Where `<name_str>` is the name of the firmware image file and `<tftp_ip>` is the IP address of the TFTP server. For example, if the firmware image file name is `image.out` and the IP address of the TFTP server is 192.168.1.168, enter:

```
execute restore image.out 192.168.1.168
```

The FortiGate unit responds with the message:

```
This operation will replace the current firmware version!  
Do you want to continue? (y/n)
```

- 6 Type `y`.

The FortiGate unit uploads the firmware image file, upgrades to the new firmware version, and restarts. This process takes a few minutes.

7 Reconnect to the CLI.

8 To confirm the new firmware image is successfully installed, enter:

```
get system status
```

9 Update antivirus and attack definitions (see the [FortiGate Administration Guide](#)), or from the CLI, enter:

```
execute update-now
```

Reverting to a previous firmware version

Use the following procedures to revert your FortiGate unit to a previous firmware version.

Use the web-based manager or CLI procedure to revert to a previous firmware version. This procedure reverts the FortiGate unit to its factory default configuration.

Reverting to a previous firmware version using the web-based manager

The following procedures revert the FortiGate unit to its factory default configuration and deletes IPS custom signatures, web content lists, email filtering lists, and changes to replacement messages.

Before beginning this procedure, it is recommended that you:

- back up the FortiGate unit configuration
- back up the IPS custom signatures
- back up web content and email filtering lists

For information, see the [FortiGate Administration Guide](#).

If you are reverting to a previous FortiOS version (for example, reverting from FortiOS v3.0 to FortiOS v2.80), you might not be able to restore the previous configuration from the backup configuration file.



Note: Installing firmware replaces the current antivirus and attack definitions, along with the definitions included with the firmware release you are installing. After you install new firmware, make sure that antivirus and attack definitions are up to date. For details, see the [FortiGate Administration Guide](#).



Note: To use this procedure, you must log in using the admin administrator account, or an administrator account that has system configuration read and write privileges.

To revert to a previous firmware version using the web-based manager

- 1 Copy the firmware image file to the management computer.
- 2 Log into the FortiGate web-based manager.
- 3 Go to **System > Status**.
- 4 Under **System Information > Firmware Version**, select Update.
- 5 Type the path and filename of the firmware image file, or select Browse and locate the file.

6 Select OK.

The FortiGate unit uploads the firmware image file, reverts to the old firmware version, resets the configuration, restarts, and displays the FortiGate login. This process takes a few minutes.

7 Log into the web-based manager.**8** Go to **System > Status** and check the Firmware Version to confirm that the firmware is successfully installed.**9** Restore your configuration.

For information about restoring your configuration, see the [FortiGate Administration Guide](#).

10 Update antivirus and attack definitions.

For information about antivirus and attack definitions, see the [FortiGate Administration Guide](#).

Reverting to a previous firmware version using the CLI

This procedure reverts the FortiGate unit to its factory default configuration and deletes IPS custom signatures, web content lists, email filtering lists, and changes to replacement messages.

Before beginning this procedure you can:

- back up the FortiGate unit system configuration using the command `execute backup config`
- back up the IPS custom signatures using the command `execute backup ipsuserdefsig`
- back up web content and email filtering lists

For information, see the [FortiGate Administration Guide](#).

If you are reverting to a previous FortiOS version (for example, reverting from FortiOS v3.0 to FortiOS v2.80), you might not be able to restore your previous configuration from the backup configuration file.



Note: Installing firmware replaces the current antivirus and attack definitions, along with the definitions included with the firmware release you are installing. After you install new firmware, use the procedure to make sure that antivirus and attack definitions are up to date. For details, see the [FortiGate Administration Guide](#). You can also use the CLI command `execute update-now` to update the antivirus and attack definitions.



Note: To use this procedure, you must log in using the admin administrator account, or an administrator account that has system configuration read and write privileges.

To use the following procedure, you must have a TFTP server the FortiGate unit can connect to.

To revert to a previous firmware version using the CLI

- 1** Make sure the TFTP server is running.
- 2** Copy the firmware image file to the root directory of the TFTP server.
- 3** Log into the FortiGate CLI.

- 4 Make sure the FortiGate unit can connect to the TFTP server.

You can use the following command to ping the computer running the TFTP server. For example, if the TFTP server's IP address is 192.168.1.168:

```
execute ping 192.168.1.168
```

- 5 Enter the following command to copy the firmware image from the TFTP server to the FortiGate unit:

```
execute restore image <name_str> <tftp_ipv4>
```

Where <name_str> is the name of the firmware image file and <tftp_ip> is the IP address of the TFTP server. For example, if the firmware image file name is v2.80image.com and the IP address of the TFTP server is 192.168.1.168, enter:

```
execute restore v2.80image.out 192.168.1.168
```

The FortiGate unit responds with the message:

```
This operation will replace the current firmware version!  
Do you want to continue? (y/n)
```

- 6 Type *y*.

The FortiGate unit uploads the firmware image file. After the file uploads, a message similar to the following is displayed:

```
Get image from tftp server OK.  
Check image OK.  
This operation will downgrade the current firmware version!  
Do you want to continue? (y/n)
```

- 7 Type *y*.

The FortiGate unit reverts to the old firmware version, resets the configuration to factory defaults, and restarts. This process takes a few minutes.

- 8 Reconnect to the CLI.

- 9 To confirm the new firmware image has been loaded, enter:

```
get system status
```

- 10 To restore your previous configuration, if needed, use the command:

```
execute restore config <name_str> <tftp_ipv4>
```

- 11 Update antivirus and attack definitions.

For information, see the [FortiGate Administration Guide](#), or from the CLI, enter:

```
execute update-now
```

Installing firmware images from a system reboot using the CLI

This procedure installs a specified firmware image and resets the FortiGate unit to default settings. You can use this procedure to upgrade to a new firmware version, revert to an older firmware version, or re-install the current firmware version.

Use this procedure to install a new firmware version or revert to a previous firmware version. To use this procedure, you must connect to the CLI using the FortiGate console port and a RJ-45 to DB-9 or null-modem cable. This procedure reverts the FortiGate unit to its factory default configuration.



Note: This procedure varies for different FortiGate BIOS versions. These variations are explained in the procedure steps that are affected. The version of the BIOS running on the FortiGate unit is displayed when you restart the FortiGate unit using the CLI through a console connection.

For this procedure you:

- Access the CLI by connecting to the FortiGate console port using a null-modem cable.
- Install a TFTP server that you can connect to from the FortiGate internal interface. The TFTP server should be on the same subnet as the internal interface.

Before beginning this procedure you can:

- back up the FortiGate unit configuration
- back up the IPS custom signatures
- back up web content and email filtering lists

For information, see the [FortiGate Administration Guide](#).

If you are reverting to a previous FortiOS version (for example, reverting from FortiOS v3.0 to FortiOS v2.80), you might not be able to restore your previous configuration from the backup configuration file.



Note: Installing firmware replaces the current antivirus and attack definitions, along with the definitions included with the firmware release you are installing. After you install new firmware, use the procedure make sure that antivirus and attack definitions are up to date. For information, see the [FortiGate Administration Guide](#).

To install firmware from a system reboot

- 1 Connect to the CLI using the null-modem cable and FortiGate console port.
- 2 Make sure the TFTP server is running.
- 3 Copy the new firmware image file to the root directory of the TFTP server.
- 4 Make sure the internal interface is connected to the same network as the TFTP server.
- 5 To confirm the FortiGate unit can connect to the TFTP server, use the following command to ping the computer running the TFTP server. For example, if the IP address of the TFTP server is 192.168.1.168, enter:

```
execute ping 192.168.1.168
```

- 6 Enter the following command to restart the FortiGate unit:

```
execute reboot
```

The FortiGate unit responds with the following message:

```
This operation will reboot the system !
Do you want to continue? (y/n)
```

- 7 Type `y`.

As the FortiGate units starts, a series of system startup messages is displayed.

When one of the following messages appears:

- FortiGate unit running v2.x BIOS

```
Press Any Key To Download Boot Image.
```

```
...
```

- FortiGate unit running v3.x BIOS

```
Press any key to display configuration menu.....
```

Immediately press any key to interrupt the system startup.



Note: You have only 3 seconds to press any key. If you do not press a key soon enough, the FortiGate unit reboots and you must log in and repeat the `execute reboot` command.

If you successfully interrupt the startup process, one of the following messages appears:

- FortiGate unit running v2.x BIOS

```
Enter TFTP Server Address [192.168.1.168]:
```

Go to step 9.

- FortiGate unit running v3.x BIOS

```
[G]: Get firmware image from TFTP server.
```

```
[F]: Format boot device.
```

```
[Q]: Quit menu and continue to boot with default
firmware.
```

```
[H]: Display this list of options.
```

```
Enter G,F,Q, or H:
```

- 8 Type `G` to get the new firmware image from the TFTP server.

The following message appears:

```
Enter TFTP server address [192.168.1.168]:
```

- 9 Type the address of the TFTP server and press `Enter`.

The following message appears:

```
Enter Local Address [192.168.1.188]:
```

- 10 Type an IP address that can be used by the FortiGate unit to connect to the FTP server.

The IP address can be any IP address that is valid for the network the interface is connected to. Make sure you do not enter the IP address of another device on this network.

The following message appears:

```
Enter File Name [image.out]:
```

- 11 Enter the firmware image filename and press Enter.

The TFTP server uploads the firmware image file to the FortiGate unit and messages similar to the following are displayed:

- FortiGate unit running v2.x BIOS
Do You Want To Save The Image? [Y/n]
Type Y.
- FortiGate unit running v3.x BIOS
Save as Default firmware/Run image without saving:[D/R]
or
Save as Default firmware/Backup firmware/Run image without saving:[D/B/R]

- 12 Type D.

The FortiGate unit installs the new firmware image and restarts. The installation might take a few minutes to complete.

Restoring the previous configuration

Change the internal interface address, if required. You can do this from the CLI using the following command:

```
config system interface
  edit internal
    set ip <address_ipv4mask>
    set allowaccess {ping https ssh telnet http}
  end
```

After changing the interface address, you can access the FortiGate unit from the web-based manager and restore the configuration.

For more information, see the [FortiGate Administration Guide](#).

If you are reverting to a previous firmware version (for example, reverting from FortiOS v3.0 to FortiOS v2.80), you might not be able to restore your previous configuration from the backup up configuration file.

The FortiUSB key



Note: The FortiUSB key requires a USB interface on the FortiGate unit. The FortiGate-50A, FortiGate-50B and FortiWiFi-50B include USB interfaces.

The FortiUSB key provides flexibility and control when you are backing up and restoring configuration files. The FortiUSB key also enables you to have a single, secure location for storing configuration files.

The FortiUSB key is used with the USB Auto-Install feature, automatically installing a configuration file and a firmware image file on a system reboot. The USB Auto-Install feature uses a configuration file and a firmware image file that is on the FortiUSB key, and on a system reboot, checks if these files need to be installed. If they do, the FortiGate unit installs the configuration file and firmware image file directly from the key to the unit.



Note: The FortiUSB key is purchased separately. The FortiGate unit only supports the FortiUSB key, available from Fortinet.

Backup and Restore from the FortiUSB key

Use the FortiUSB key to backup a configuration file or restore a configuration file.

You should always make sure the FortiUSB key is properly installed before proceeding since the FortiGate unit must recognize that the key is installed in its USB port.



Note: You can only save VPN certificates if you encrypt the file. Make sure the configuration encryption is enabled so you can save the VPN certificates with the configuration file. However, an encrypted file is ineffective if selected for the Auto-Install feature.

To backup a FortiGate configuration using the web-based manager

- 1 Go to **System > Maintenance > Backup and Restore**.
- 2 Select USB Disk from the Backup configuration to list.
- 3 Select Backup.

If you want to encrypt the configuration file, select Encrypt configuration file and enter a password, then select Backup. The password is also used when you are restoring the configuration file.

To restore configuration using the web-based manager

- 1 Go to **System > Maintenance > Backup and Restore**.
- 2 Select USB Disk from the Restore configuration from list.
- 3 Select the configuration file you want restored in the Filename list.

If you have a password for the configuration file, enter it in the Password field.

- 4 Select Restore.

To backup configuration using the CLI

- 1 Log into the CLI.
- 2 Enter the following command to backup the configuration files:

```
exec backup config usb <filename>
```

- 3 Enter the following command to verify the configuration files are on the key:

```
exec usb-disk list
```

To restore configuration using the CLI

- 1 Log into the CLI.
- 2 Enter the following command to restore the configuration files:

```
exec restore config usb <filename>
```

The FortiGate unit responds with the following message:

```
This operation will replace the current firmware version!
```

```
Do you want to continue? (y/n)
```

- 3 Type `y`.

Using the USB Auto-Install feature

The USB Auto-Install feature automatically updates the FortiGate configuration file and image file on a system reboot. Also, this feature provides you with an additional backup if you are unable to save your system settings before shutting down or rebooting your FortiGate unit.

The following procedures use both the web-based manager and the CLI. However, it is recommended you use the CLI since the login screen may appear before the installation is complete. The FortiGate unit may reboot twice if installing the firmware image and configuration file.



Note: You need an unencrypted configuration file for this feature. Also the default files, `image.out` and `fgt_system.conf`, must be in the root directory.



Note: Make sure FortiOS 3.0MR1 is installed on the FortiGate unit before installing.

To configure the USB Auto-Install using the web-based manager

- 1 Go to **System > Maintenance > Backup and Restore**.
- 2 Select the blue arrow to expand the Advanced options.
- 3 Select the following:
 - On system restart, automatically update FortiGate configuration file if default file name is available on the USB disk.
 - On system restart, automatically update FortiGate firmware image if default image is available on the USB disk.
- 4 Enter the configuration and image filenames or use the default configuration filename (`fgt_system.conf`) and default image name (`image.out`).
- 5 Select Apply.

To configure the USB Auto-Install using the CLI

- 1 Log into the CLI.
- 2 Enter the following command:

```
config system auto-install
    set default-config-file <filename>
    set auto-install-config <enable/disable>
    set default-image-file <filename>
    set auto-install-image <enable/disable>
end
```

Additional CLI commands for the FortiUSB key

Use the following CLI commands when you want to delete a file from the FortiUSB key, list what files are on the key, including formatting the key or renaming a file:

- `exec usb-disk list`
- `exec usb-disk delete <filename>`
- `exec usb-disk format`
- `exec usb-disk rename <old_filename1> <old_filename2>`



Note: If you are trying to delete a configuration file from the CLI, and the filename contains spaces, you will need quotations around the filename before you can delete the file from the FortiUSB key.

Testing a new firmware image before installing it

You can test a new firmware image by installing the firmware image from a system reboot and saving it to system memory. After completing this procedure, the FortiGate unit operates using the new firmware image with the current configuration. This new firmware image is not permanently installed. The next time the FortiGate unit restarts, it operates with the originally installed firmware image using the current configuration. If the new firmware image operates successfully, you can install it permanently using the procedure [“Upgrading to a new firmware version” on page 65](#).

Use this procedure to test a new firmware image before installing it. To use this procedure, you must connect to the CLI using the FortiGate console port and a RJ-45 to DB-9 or null-modem cable. This procedure temporarily installs a new firmware image using your current configuration.

For this procedure you:

- Access the CLI by connecting to the FortiGate console port using a RJ-45 to DB-9 serial cable or null-modem cable.
- Install a TFTP server that you can connect to from the FortiGate internal interface. The TFTP server should be on the same subnet as the internal interface.

To test a new firmware image

- 1 Connect to the CLI using a RJ-45 to DB-9 serial cable or a null-modem cable and FortiGate console port.
- 2 Make sure the TFTP server is running.
- 3 Copy the new firmware image file to the root directory of the TFTP server.

- 4 Make sure the internal interface is connected to the same network as the TFTP server.

You can use the following command to ping the computer running the TFTP server. For example, if the TFTP server's IP address is 192.168.1.168:

```
execute ping 192.168.1.168
```

- 5 Enter the following command to restart the FortiGate unit:

```
execute reboot
```

- 6 As the FortiGate unit reboots, press any key to interrupt the system startup. As the FortiGate unit starts, a series of system startup messages are displayed.

When one of the following messages appears:

- FortiGate unit running v2.x BIOS
Press Any Key To Download Boot Image.
...
- FortiGate unit running v3.x BIOS
Press any key to display configuration menu.....

- 7 Immediately press any key to interrupt the system startup.



Note: You have only 3 seconds to press any key. If you do not press a key soon enough, the FortiGate unit reboots and you must log in and repeat the `execute reboot` command.

If you successfully interrupt the startup process, one of the following messages appears:

- FortiGate unit running v2.x BIOS
Enter TFTP Server Address [192.168.1.168]:
Go to step 9.
- FortiGate unit running v3.x BIOS
[G]: Get firmware image from TFTP server.
[F]: Format boot device.
[Q]: Quit menu and continue to boot with default firmware.
[H]: Display this list of options.

Enter G, F, Q, or H:

- 8 Type G to get the new firmware image from the TFTP server.

The following message appears:

```
Enter TFTP server address [192.168.1.168]:
```

- 9 Type the address of the TFTP server and press Enter.

The following message appears:

```
Enter Local Address [192.168.1.188]:
```

- 10** Type an IP address that can be used by the FortiGate unit to connect to the FTP server.

The IP address can be any IP address that is valid for the network the interface is connected to. Make sure you do not enter the IP address of another device on this network.

The following message appears:

```
Enter File Name [image.out]:
```

- 11** Enter the firmware image file name and press Enter.

The TFTP server uploads the firmware image file to the FortiGate unit and messages similar to the following appear.

- FortiGate unit running v2.x BIOS

```
Do You Want To Save The Image? [Y/n]
```

Type N.

- FortiGate unit running v3.x BIOS

```
Save as Default firmware/Run image without saving:[D/R]
```

or

```
Save as Default firmware/Backup firmware/Run image without saving:[D/B/R]
```

- 12** Type R.

The FortiGate image is installed to system memory and the FortiGate unit starts running the new firmware image but with its current configuration.

- 13** You can log into the CLI or the web-based manager using any administrative account.

- 14** To confirm the new firmware image has been loaded, from the CLI enter:

```
get system status
```

You can test the new firmware image as required.

Installing and using a backup firmware image

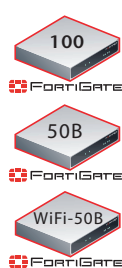

The following procedures are specific to the FortiGate-100, FortiGate-50B and FortiWiFi-50B.

If the FortiGate unit is running BIOS version v3.x, you can install a backup firmware image. Once the backup firmware image is installed you can switch to this backup image when required.

Installing a backup firmware image

To run this procedure you:

- Access the CLI by connecting to the FortiGate console port using a RJ-45 to DB-9 serial cable or null-modem cable.
- Install a TFTP server that you can connect to from the FortiGate as described in the procedure [“Installing firmware images from a system reboot using the CLI” on page 70.](#)

To install a backup firmware image

- 1 Connect to the CLI using a RJ-45 or DB-9 serial cable or a null-modem cable and FortiGate console port.
- 2 Make sure the TFTP server is running.
- 3 Copy the new firmware image file to the root directory of your TFTP server.
- 4 To confirm the FortiGate unit can connect to the TFTP server, use the following command to ping the computer running the TFTP server. For example, if the IP address of the TFTP server is 192.168.1.168:

```
execute ping 192.168.1.168
```

- 5 Enter the following command to restart the FortiGate unit:

```
execute reboot
```

As the FortiGate unit starts, a series of system startup messages are displayed.

When of the following message appears:

```
Press any key to enter configuration menu.....
```

- 6 Immediately press any key to interrupt the system startup.



Note: You have only 3 seconds to press any key. If you do not press a key soon enough, the FortiGate unit reboots and you must log in and repeat the `execute reboot` command.

If you successfully interrupt the startup process, the following message appears:

```
[G]: Get firmware image from TFTP server.
```

```
[F]: Format boot device.
```

```
[Q]: Quit menu and continue to boot with default firmware.
```

```
[H]: Display this list of options.
```

Enter G, F, Q, or H:

- 7 Type G to get the new firmware image from the TFTP server.

The following message appears:

```
Enter TFTP server address [192.168.1.168]:
```

- 8 Type the address of the TFTP server and press Enter.

The following message appears:

```
Enter Local Address [192.168.1.188]:
```

- 9 Type an IP address that can be used by the FortiGate unit to connect to the FTP server.

The IP address can be any IP address that is valid for the network the interface is connected to. Make sure you do not enter the IP address of another device on this network.

The following message appears:

```
Enter File Name [image.out]:
```

- 10 Enter the firmware image file name and press Enter.

The TFTP server uploads the firmware image file to the FortiGate unit and the following message is displayed.

```
Save as Default firmware/Backup firmware/Run image without saving:[D/B/R]
```

- 11 Type B.

The FortiGate unit saves the backup firmware image and restarts. When the FortiGate unit restarts it is running the previously installed firmware version.

Index

A

adding a default route 38, 41

C

CAT5 20

certificate, security 22

CLI

additional CLI commands, FortiUSB 75

connecting 23

upgrading the firmware 66, 68

comments, documentation 13

configuring

redundant mode 52

standalone mode 52

connecting

to the CLI 23

to the web-based manager 21

customer service 13

D

dead gateway detection 55

default

adding a route 38, 41

restoring settings 31

DHCP

configuration 37

documentation

commenting on 13

Fortinet 12

E

Ethernet, Power 20

F

factory defaults

DHCP server configuration 28

firewall configuration 29

NAT/Route mode config 28

protection profiles 30

Transparent mode config 29

firewall policies

modem 56

firmware

backup and restore from FortiUSB key 73

install, backup firmware image 77

installing 70

re-installing current version 70

restoring previous config 72

reverting to an older version 70

testing new firmware 75

upgrading to a new version 65

upgrading using the CLI 66, 68

upgrading using the web-base manager 31, 65, 67

FortiGate documentation

commenting on 13

Fortinet 9

Fortinet customer service 13

Fortinet documentation 12

Fortinet Family Products 9

FortiBridge 10

FortiClient 9

FortiGuard 9

FortiLog 10

FortiMail 9

FortiManager 10

FortiReporter 10

Fortinet Knowledge Center 13

FortiUSB key

additional CLI commands 75

backup and restore 73

USB Auto-Install 74

G

grounding 20

I

IEEE 802.3af 20

installing factory defaults 24

introduction

Fortinet documentation 12

L

LED descriptions 19

M

modem

adding firewall policies 56

redundant mode 51

standalone mode 51, 52

modem CLI commands

altmode 53

auto-dial 53

connect_timeout 53

dial-on-demand 53

holddown-timer 53

idle-timer 53

interface 53

mode 53

passwd1 53

passwd2 54

passwd3 54

peer_modem1 54

peer_modem2 54

phone1 54

phone2 54

phone3 54

redial 54

status 54

username1 54

username2 54

username3 54

mounting 19

N

NAT/Route mode
 settings 36
 using the CLI 39
 using the web-based manager 37
 NTP server 46
 NTP server synchronize 46

P

ping requests, preventing public FortiGate interface
 from responding to 35
 ping server 55
 PoE 20
 Power over Ethernet 20
 PPPoE configuration 37
 products, Fortinet family 9
 protection profiles, default 30

R

reconnecting to the web-based manager 45
 redundant mode
 configuring 52
 modem 51
 registering the FortiGate unit 8
 restoring default settings 31
 restoring previous firmware config 72
 reverting, to an older firmware version 70

S

security certificate 22
 set time 46
 standalone mode

configuring 52
 modem 51, 52
 synchronize with NTP server 46

T

technical support 13
 time zone 46
 Transparent mode
 changing to 44
 settings 43
 using the CLI 44
 using web-based manager 43

U

updating
 adding override server 49
 antivirus and IPS, web-based manager 47
 IPS using CLI 48
 scheduling updates 48
 upgrading
 firmware 65
 firmware using the CLI 66, 68
 firmware using the web-based manager 31, 65, 67
 USB Auto-Install feature 74

V

verifying
 connection 41, 45, 46
 connection, web-based manager 39
 web-based manager connection 39

W

wall mounting 19
 web-based manager, connecting 21



www.fortinet.com



www.fortinet.com

Free Manuals Download Website

<http://myh66.com>

<http://usermanuals.us>

<http://www.somanuals.com>

<http://www.4manuals.cc>

<http://www.manual-lib.com>

<http://www.404manual.com>

<http://www.luxmanual.com>

<http://aubethermostatmanual.com>

Golf course search by state

<http://golfingnear.com>

Email search by domain

<http://emailbydomain.com>

Auto manuals search

<http://auto.somanuals.com>

TV manuals search

<http://tv.somanuals.com>