



**Digital Master Recorder
Model D-20B**

Operation Manual

Fostex

TABLE OF CONTENTS

INTRODUCTION	4
Section 1. OUTLINE OF DAT STANDARD	5
Section 2. FEATURE OVERVIEW	9
Section 3. CONTROLS AND FUNCTIONS	12
Front Panel	-12
Rear Panel	-25
Section 4. SET UP	28
1. Location	-28
2. Connections	-28
3. Setting the Mode Select Digital Switches (rear panel)	-28
Section 5. RECORDING	34
1. Recording Analog Sources	-35
2. Time Code Recording	-36
3. Mute Recording of Audio	-38
4. Recording Digital Sources	-39
5. Punch-in/Punch-out Recording	-39
Section 6. FUNCTION AND OPERATING OF THE KEYS	41
1. Display Counter Messages	-41
2. Display Key Operation	-42
3. Locating by Time	-45
4. Locating by Program Numbers	-47
5. Blank Search	-48
6. Variable Speed Function	-49
7. Cueing	-50
8. Chase Function	-50
9. Internal Time Code Generator	-52
10. Jum Sync Function	-53

Section 7. Set Up Menu 55

1. Set Up Menu -55
2. Set Up Data -56
3. Additional Notes -61

Section 8. Application Examples..... 62

1. Editing System using a VIDEO EDITOR -62
2. Audio Insert from a D-20B to a VTR -64
3. Copying source VTR and D-20B sound to a VTR -66
4. Chase sync between a VTR and a multiple number of D-20Bs -67
5. VTR and D-20B chase system using a Fostex 4030 for auto control -68
6. Producing a soft tape for DAT FRAME SYNC -69
7. Digital connections with other equipments -70
8. Set Up of the 4030 synchronizer -73
9. Set Up of the D-20B -75

Section 9. RS-422A SERIAL PORT 76

1. How to Make Digital Copies -76
2. 9 pin DATA COM Remote Control -79

Section 10. SPECIFICATIONS 81

1. Connector Pin Assignments -81
2. Specifications -82
3. Dimensional Drawings -84

APPENDIX : Signal Format 85

1. Main ID Format of Audio PCM Signal -85
2. Pack Format of Sub Data -87
3. IEC Standard #958 Digital Audio Interface -89

INTRODUCTION

Congratulations on your purchase of the Fostex D-20B. This digital master recorder uses the DAT (Digital Audio Tape system) standard making it compatible with all standard DAT recordings produced on professional as well as home recording equipment (consumer use). While fully realizing the tremendous performance potential of the DAT standard, the D-20B is designed to have the same operating "feel" and features of a conventional reel-to-reel analog master recorder with two stereo tracks and a center track for SMPTE/EBU time code. As with all Fostex products, the D-20B is a rugged, reliable and sophisticated piece of equipment with superior sonic characteristics. The D-20B may also be used as a slave recorder for VCR, etc. when it is combined with a model 4030 synchronizer. We, at Fostex, hope that the D-20B will help you in your creative projects. If you have any questions or comments about this or any other Fostex product, please do not hesitate to call your local Fostex Service Center. We will be glad to assist you in any way we can. Please read this manual carefully before using your D-20B to ensure proper understanding of all of its features. With proper care the D-20B, like all Fostex equipment, will give you many years of outstanding performance.

Digital Audio Tape (DAT) technology is a recent phenomenon of the recording world. Using a variety of concepts from different recording formats, DAT is the perfect recording tool for those studios who demand the highest production standards. DAT employs a rapidly spinning rotary head module to encode and decode digitized information onto a standardized DAT tape cassette. In the D-20B, this format, formalized under the DAT, has been further improved by the inclusion of SMPTE/EBU time code recording. This means that the superior capabilities of digital recording can be synchronized to visual information, i.e., film and television. Not only is the D-20B much less expensive to own and operate than a stationary head digital recorder, the DAT format is inherently superior in terms of tape costs and sonic integrity. DAT is a format that will revolutionize what engineers can do in the studio. While the technology is complex it is, in practice, a very simple format to use. The D-20B has become a workhorse in recording, film, television and animation studios around the world. We at Fostex are proud to be the leaders in the field of professional DAT recorders and wish you the best in your creative efforts.

Section 1.

OUTLINE OF DAT STANDARD

The D-20B is a master recorder for professional use that has been constructed using the standards that are under approval by the IEC. These standards, written in the IEC DAT standard book, cover the following six parts:

- Part 1. Dimensions and characteristics
- Part 2. DAT calibration tape
- Part 3. DAT tape properties
- Part 4. Methods of measurement for DAT recorders
- Part 5. DAT for professional use
- Part 6. SCMS for consumer use of DAT recorders

< Note >

The D-20B meets all applicable standards except Part 6.

DAT Standard

DAT employs a rotary head type mechanism as shown in Figure 1. By using high density tapes and this rotating head, two hours of information can be recorded on a small cassette. The rotary drum is 30 mm in diameter, revolves at 2,000 rpm and has a set of heads consisting of a plus azimuth type and a minus azimuth type placed, 180 degrees from each other. As the wrap around angle on the drum is 90 degrees, the reproduced head output will be intermittent at 7.5 msec as shown in Figure 2. One revolution of the drum is called one frame. Digital signal processing such as error correction is carried out during the head "no output" period.

Figure 1
Rotaryhead and tape

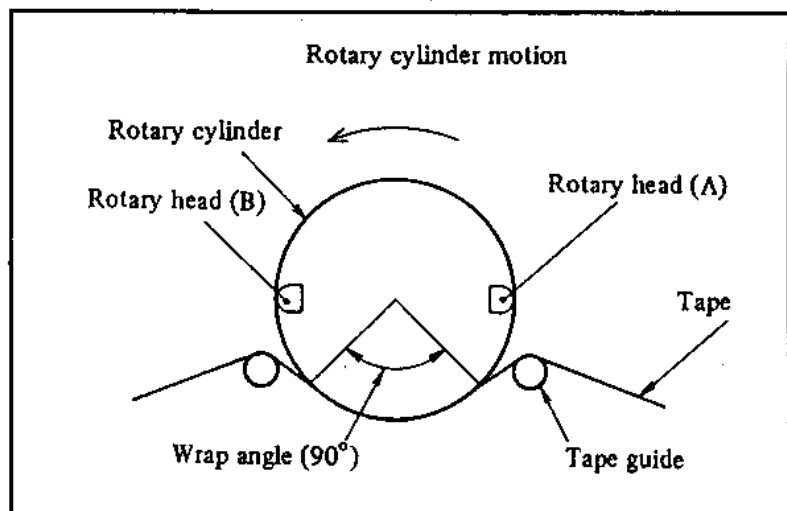

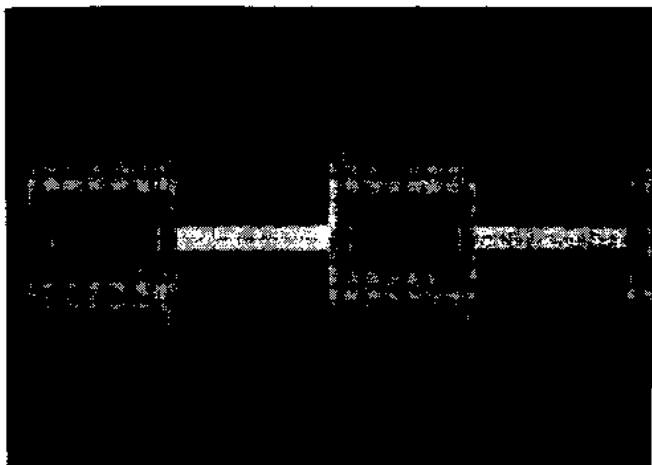

Figure 2
Playback output

Track configuration is shown in Figure 3. Identical to VTR, it employs guard-band-less-azimuth recording. The head track width is about $20 \mu\text{m}$ and track width subsequent to recording is about $13.6 \mu\text{m}$. One track consists of areas for audio PCM, two sub data, two ATF (Automatic Track Finding) and a margin. One track is divided into 196 blocks, the audio PCM area into 128 blocks, sub data area into 8 blocks each and the ATF area are each made up of 5 blocks of data.

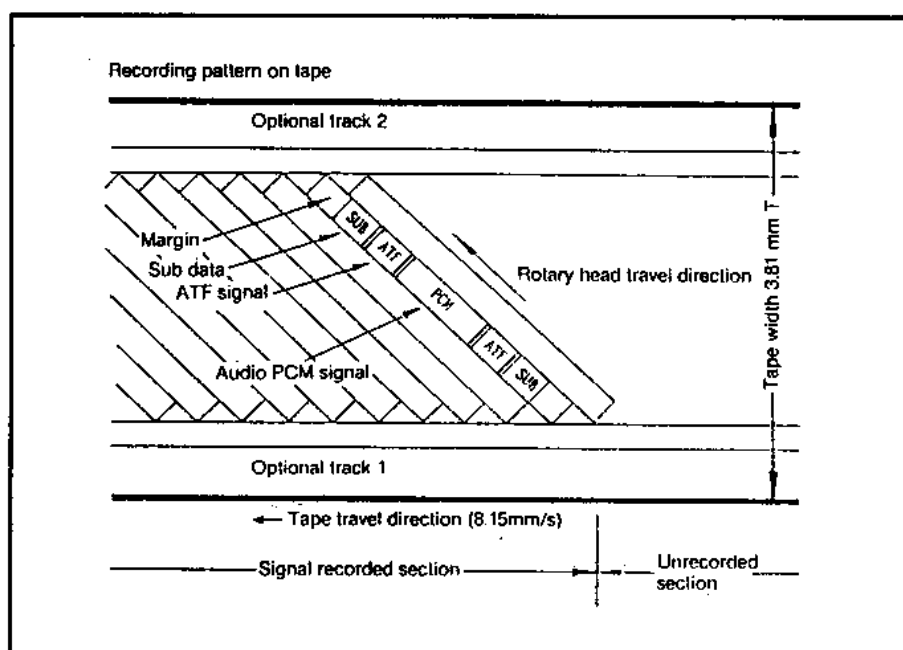

Figure 3
Track format

Audio PCM data area: This area is recorded sound information (music, voice, etc.) digitized by PCM (Pulse Code Modulation) and the error correction data (Double Reed-Solomon Code). Interleave is completed in one frame (two tracks).

A PCM data area of one track is composed of 128 blocks. One block, as shown in Figure 4, consists of synchronized data, main ID* (identification)

which discriminates the audio PCM contents, main ID parity and main data which is made of the audio PCM data and error correction data.

* Please refer to the Appendix for details of main ID.

Figure 4

The block composition of audio PCM data.

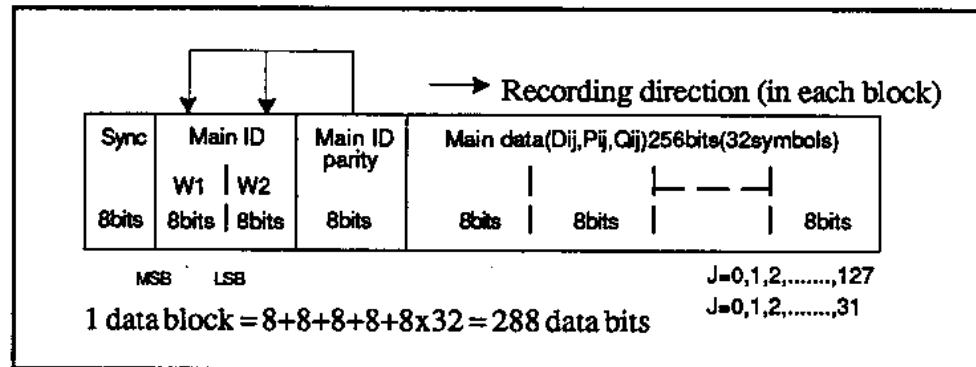

Sub data area: This area is for recording information other than audio PCM data; that is to say, start ID (a flag which indicates the head [start] of a program), program number, A-Time (absolute time; indicates the time from the tape beginning), and program time (indicates the time from a program beginning), etc.

Figure 5

The block composition of sub data.

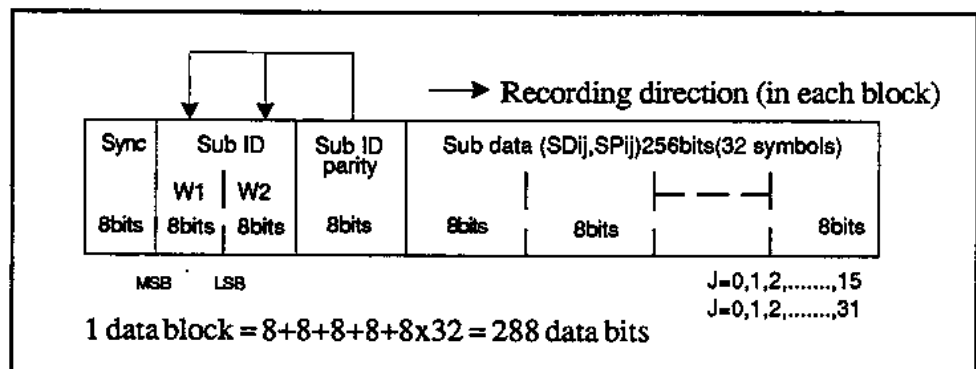

Sub data area, as shown in Figure 5, is the same block composition as audio PCM data area. There are 8 blocks each in sub data areas 1 and 2. Sub data employs the pack system, and consists of 7 packs.

* Please refer to APPENDIX for the detail of Sub ID and Sub data.

The D-20B records A-Time in pack area 1. This is used for locating the tape address. In addition, the D-20B records SMPTE/EBU time code in pack areas 2 and 3. Time code can be rewritten without erasing the other data. In the case of recording a time code on prerecorded tape with another recorder, the information will be recorded in the non-recorded packs. When using a prerecorded tape with more than 6 packs, the time code will be recorded automatically to the pack areas 6 and 7. Therefore, previous data will be erased.

ATF signal area: The ATF area is for recording a tracking signal which is then exactly traced. This enables the recorder to play the previously recorded data accurately. This area is composed of two signals; one signal is 130 kHz pilot signal. The second signal is for distinguishing track location.

Recording: In DAT, one track (audio PCM signal data, sub data, ATF signal data) is recorded simultaneously. Sub data, however, can be rewritten by overwriting. Therefore, the method of operation is slightly different than conventional longitudinal recording in which each channel is completely separated.

For example, in the D-20B NORMAL mode, AUDIO READY and TIME CODE READY (recording in the sub data area) are setup in combination. However, by employment of the four head, independent time code recording is possible by using EDIT mode.

Erasing: Erasing is accomplished by overwriting. Even though it is erased by no-signal recording (audio mute), data will remain on the tape. The DAT system will not correctly reproduce the tape unless these three signals are present. Erasing is accomplished by overwriting. Because of this, the recorder must comprehend the *no recording state* of the tape (virgin tape) from the *no information state* (mute recording, or erasing) as they are two different situations. In other words, if a recording is made even once on the tape, that section is considered to be recorded; even if there is no audio or time code signals on the tape it is no longer "virgin" or blank tape.

Word: The sampling data that is sampled by the sampling frequency shall be called "WORD" in this manual. The word "SYNCHRONIZATION" means that the data is synchronized by a sample unit.

Order of sampling: For consumer use, there are two sampling methods. One is two channels sampled at the same time. The other method is two channels sampled alternately. The D-20B uses the first method, that is, both channels sampled at the same time. However, the D-20B will play back tapes recorded in method two above; there is a possibility of phase difference at about 10 μ sec.

Section 2.

FEATURE OVERVIEW**Four-head Design**

In the D-20B, a four head system is employed, as shown in Figure 6. This allows tape monitoring, seamless punch in/out and the independent recording of time code. The heads are located 90 degrees apart from each other and the heads located 180 degrees apart are used in pairs. By using four heads the above described functions are made possible. The above requirements are achieved by using these leading head pairs (rotary heads A and B) and trailing heads (rotary heads A' and B') for recording or playback. To achieve accurate punch in/out, the difference in height between rotary head A, B pairs and rotary head A', B' pairs are specified at $88.4 \mu\text{m}$ (3.25 frames).

Figure 6
Four-head design

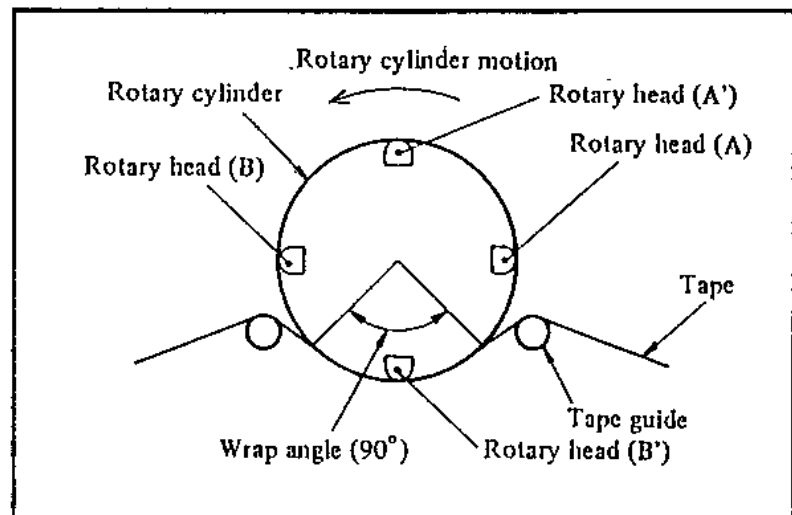

■ Confidence monitor (Off the tape monitoring)

EDIT MODE key in "OFF" (LED will not light) position

Figure 7
Confidence monitor

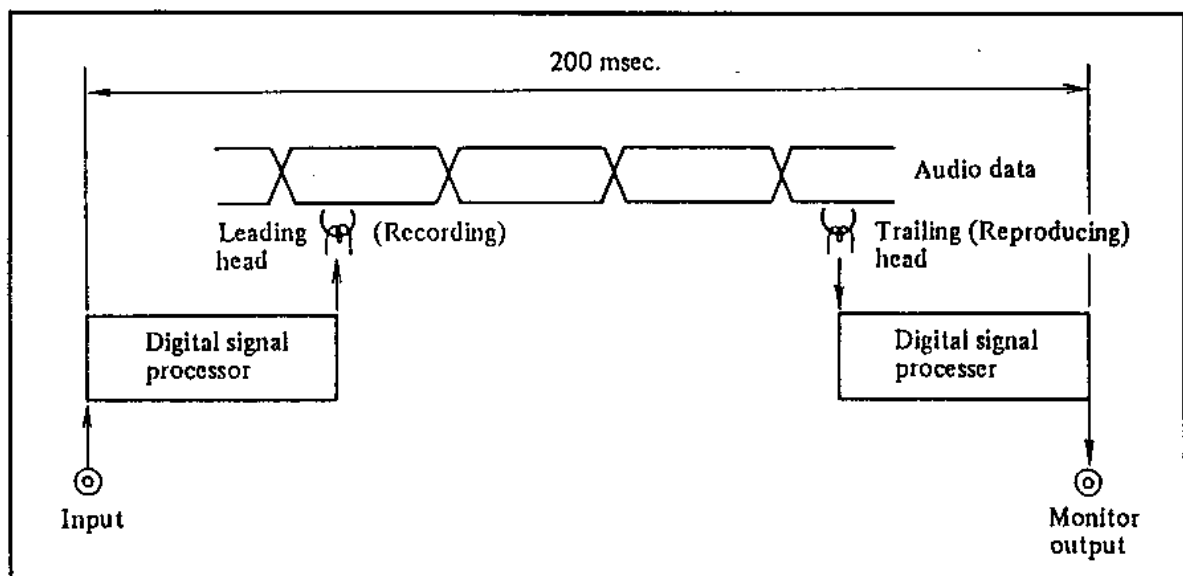

As shown in Figure 7, this is the mode whereby the leading head is used for recording and the trailing head for playback. Recording is made on the assumption that the tape has not been prerecorded. Delay time of the playback monitor is about 200 msec.

■ Punch-in/punch-out recording

EDIT MODE key in "ON" (LED will light) position

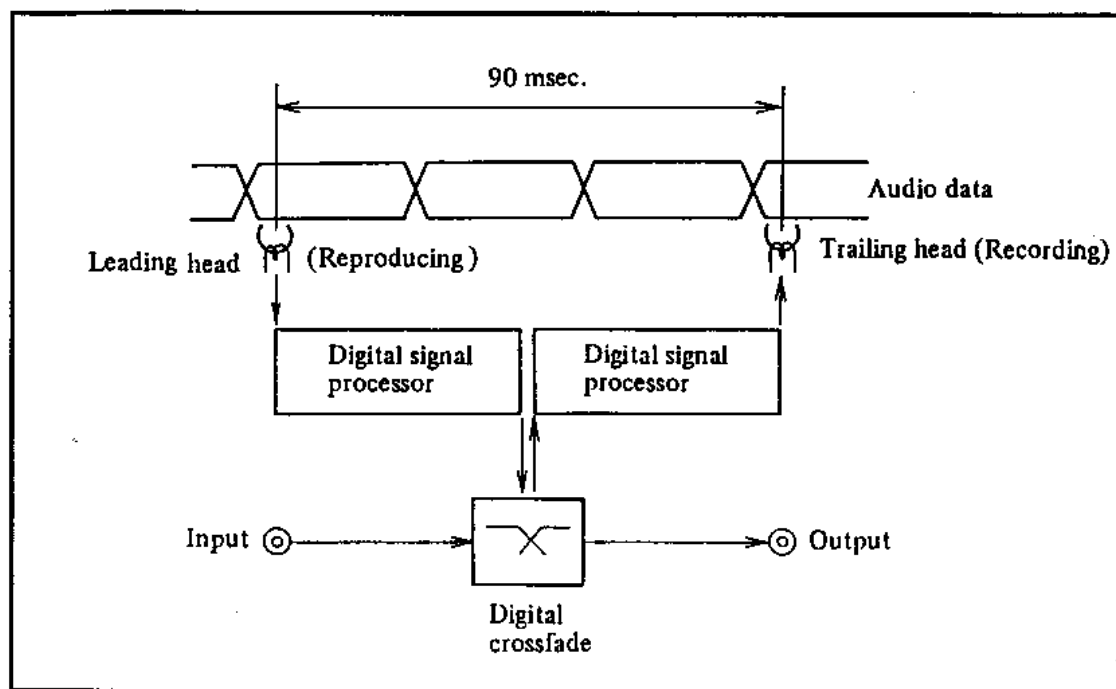

Figure 8
Punch-in/punch-out recording

In this mode, the leading head is used for playback and the trailing head for recording as shown in Figure 8. Accurate punch in/out is conducted by matching the digital signal processing time (about 90 msec.) with the playback head to recording head tape travel time. In this mode recorded track on the tape is traced with the leading playback head by the ATF signal and recorded by the trailing head in exactly the same track pattern. As the pattern will be recorded accurately, the above normal mode is recommended when making a new recording on a prerecorded tape.

Digital crossfade is employed for seamless punch in/out. The crossfade time is 10 msec.

Remote Control

Search and editing of the SUB-ID's is possible by using a Fostex 8320 remote control unit (optional).

Display indication by SMPTE/EBU time code, as well as, setup of locate, chase control, chase offset, and internal time code are possible.

The D-20B DIP switch can be set up remotely. Please refer to the Fostex 8320 owner's manual for details.

RS-422A Remote Control

As this complies with Sony 9 pin protocol, communication by RS-422A (D-sub 9 pin) is possible. The D-20B can be controlled by editors and recorders which employ this protocol.

Digital Copy of All Data

All data that are recorded by the D-20B, including sub data, can be copied. Please refer to Section 9 "How to Make Digital Copies" on page 76 for details.

DAT Frame Synchronization

A DAT frame sync connector has been provided. A multiple number of D-20Bs can be synchronized at less than word clock accuracy by using the D-20B chase sync function. In this way, a multitrack recorder may be created using a number of D-20Bs synchronized together.

D-20B as a master machine when inputting a digital signal

When a digital signal is input, the D-20B usually syncs with the clock of the input signal automatically as a slave machine.

However, when connecting a digital mixer output with a D-20B input, using the D-20B as a master machine might be better.

For this purpose, it is possible to select the input clock signal non sync. mode on the D-20B.

Chase Synchronizer Function

Chase function of offset "0" by independent use of D-20B but chase sync together with offset is possible when it is used in combination with an 8320 or by RS-422A command.

Time Code Generator Function

Two time code functions in the D-20B. The first mode applies force jam against the time code from the EXTERNAL TIME CODE IN input and is then entered into free run. The second mode is jam sync that operates only in the record mode after jam sync is applied against time code previously recorded on the tape. In both of these situations, time code data may be setup from a main unit or with an 8320.

Section 3

CONTROLS AND FUNCTIONS**FRONT PANEL**

Figure 9
Front panel view

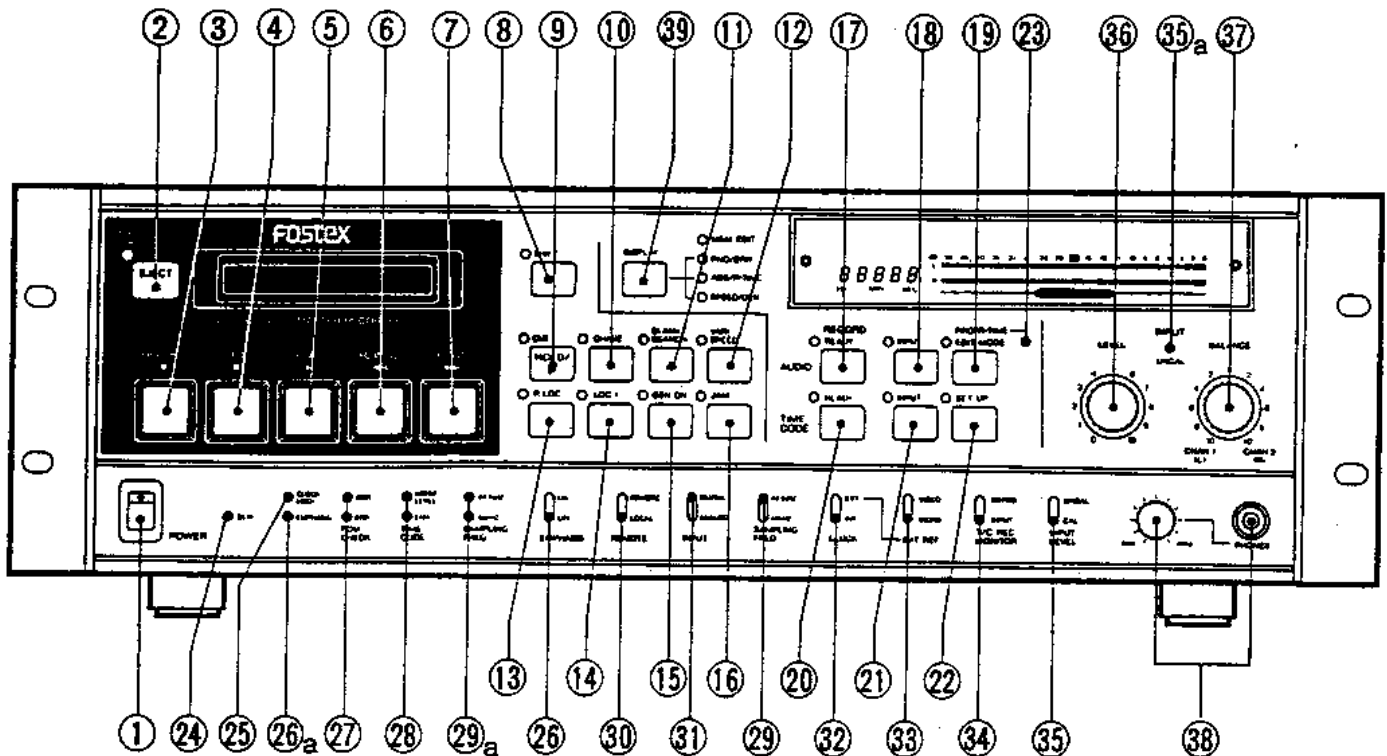
**1. POWER switch****2. EJECT button**

Press to eject the DAT cassette. The **EJECT** button only works in the stop and pause mode. When the tape is being loaded or unloaded by the cassette transport, the **TAPE LOAD LED** will blink. When there is a tape in the machine, this LED will remain lit.

3. RECORD button [●]

When the **AUDIO READY** key or the **TIME CODE READY** key are ON, pressing this button and the **PLAY** button puts the unit in the **RECORD** mode. The **RECORD** button will light red. This key will not function if the cassette "record protect" hole is open. If a recording is to be made, please make sure that the record protect hole is closed.

4. STOP button [■]

The **STOP** button has two steps in its function. Pressing this button once puts the transport into the pause mode. The **STOP** button will light while the **PLAY** button will blink. Pressing this button twice will put the transport into full stop mode. Only the **STOP** button will be lit.

< Note >

The pause mode is incorporated to reduce start up time. However, the transport will enter full stop mode if the pause mode is engaged longer than selected Pause Time. The reason for this is to remove the tape surface from contact with the rotary head drum and protect the tape from premature tape wear. Each push of the **STOP** button will alternate the transport from stop to pause mode.

For further details on:

Set up Menu , page 55 ~ 60.

5. PLAY button [►]

Pressing this button puts the unit in playback mode; the **PLAY** button will light. When pressed with the **RECORD** button it also serves to activate the recording mode. The **PLAY** button also will engage other functions such as repeat and locate play; these will be explained latter.

6. REWIND button [◀◀]

When this button is pressed once, the tape is rewound at five times normal speed and the **PLAY** and **REWIND** buttons are lit. Pressing the button once more will activate high speed winding (100 times normal speed). Only the **REWIND** button will be lit. Each press of the **REWIND** button will cause the machine to alternate between high and low speed rewinding.

7. F FWD button [▶▶]

The **FFWD** button operates in the same manner as the **REWIND** button.

8. SHIFT key

Keys 9 through [14], [17] and [39] have dual functions. Pressing the **SHIFT** key engages these separate functions as will be explained below. The **SHIFT LED** will light when the **SHIFT** key is engaged. Each push of the **SHIFT** key alternates between the shift and non-shift mode.

9. HOLD/CURSOL/CUE key [HOLD/ ►]

Non-shift mode: When this key is pressed, the display counter may be held, the edit point can be moved, and the display number can be set in the setup menu.

Shift mode: When this key is pressed, cue function may be set.

For further details on:

MEM EDIT, please refer to page 42.

Cueing, page 50.

Set Up menu, page 55 ~ 60.

10. DOWN CHASE key [▼]

Non-shift mode: When this key is pressed, the display counter number will be reduced in the MEMEDIT, VARI SPEED and Setup Menu.

Shift mode: When this key is pressed, chase operation is started (CHASE LED blinks), moving towards the reference time code position that is input to the rear panel TIME CODE INPUT [43] or to the reference time code position where it had last stopped. When the reference and tape time code lock are established, CHASE LED will be lit and the tape will travel at standard speed (VARI SPEED = 0).

For further details on:

Chase Mode Operation, please refer to page 50.

Down Key Operation, page 45 ~ 49, 55.

Set Up Menu, page 55 ~ 60.

11. UP/BLANK SEARCH key [▲]

Non-shift mode: When this key is pressed, the display counter number will be increased in the MEM EDIT, VARI SPEED and Setup Menu modes.

Shift mode: When this key is pressed, the blank search function can be set and the BLANK SEARCH LED will be lit.

For further details on:

Up Key Operation, please refer to page 45 ~ 49, 55.

Blank Search Operation, page 48.

Set Up Menu, page 55 ~ 60.

12. VARI SPEED key

Non-shift mode: Reserved.

Shift mode: Pressing the key activates the VARI SPEED mode. The VARI SPEED LED will light up and the display will show the current value in percent with normal speed represented as 00. Tape speed can be varied plus or minus ten percent with the ▲ and ▼ keys.

For details on:

Variable Speed Function, please refer to page 49.

13. PLAY LOCATE key

Non-shift mode: When this key is pressed, the tape is located to the point stored in P.LOC memory where PLAY or REPLAY was last started. When ABS is displayed in the MEM. EDIT mode, the display counter time is stored in P.LOC.

Shift mode: Time stored in P. LOC memory can be displayed by pressing the shift key.

For details on:

Play Locate Operation, please refer to page 45, 46.

14. LOCATE 1 key

Non-shift mode: When this key is pressed, the tape will be located to the point stored in LOC 1. If ABS/R-Time is displayed in the MEM EDIT mode, the display counter time will be stored in LOC. 1. If PROG. NO. is displayed, the tape will locate to this program number.

Shift mode: When this key is pressed, the time point stored in LOC. 1 will be displayed.

For details on:

LOC. 1 operation, please refer to page 45 ~ 47.

15. GENERATOR ON key

This key is the time code generator starting switch for PRO R-Time (IEC format) and cannot be used with the FOSTEX format. This key will force jam the time code generator into sync with the phase of the time code signal input to the main rear panel TIME CODE INPUT [43]. If there is no signal to TIME CODE INPUT, and the generator is temporarily stopped and restarted, the time code generator will free run in continuance to the time when it was stopped.

For details on:

Starting the Generator, please refer to page 52.

16. JAM (Jam) key

This key is used to record time codes continuous to the PRO R-time (IEC format) time code recorded on the tape, and is normally used for assemble editing. This cannot be used in the Fostex format.

For details on:

Jam Sync Operation, please refer to page 53.

17. AUDIO READY (Audio Record Ready) key

Audio ready is switched on and off with this key. It is switched on when the key is pressed once. The READY LED will be lit. In the normal mode (EDIT MODE key 19 = OFF) TIME CODE READY will be simultaneously switched on or off and both AUDIO READY and TIME CODE READY LEDs will be lit. Also, by pressing the SHIFT key [8] and AUDIO READY key [17], audio "0" can be mute recorded. The AUDIO READY LED will blink. To cancel audio record mute, press this key again.

For details on:

Recording, please refer to page 34 ~ 40.

18. AUDIO INPUT key

Audio input or Repro is selected by this key. Each condition is indicated by the INPUT LED lighting status as shown below:

LED	MODE
ON	Input Monitor
OFF	Repro Monitor
BLINK	Cross Fade Input Monitor

The D-20B will alternate between audio input and repro each time this key is pressed. In the CROSS FADE INPUT MONITOR mode, repro monitor will automatically switch to input monitor whenever RECORD or REHEARSAL REC mode is entered.

19. EDIT MODE (Edit Mode) key

This key will switch between NORMAL mode (read after write) and EDIT mode (write after read). Pressing the key toggles the recorder between these two modes; however, it will not switch when in REPRO or REHEARSAL REC. The condition set will be stored even though the power is switched ON/OFF. The D-20B is set to normal when leaving the factory. Each mode is as follows:

NORMAL MODE (LED:OFF)	Normal record/playback mode. Because simultaneous record/playback is possible, the tape can be monitored while recording (Audio and Time code are simultaneously recorded).
EDIT MODE (LED:ON)	In addition to normal assemble recording, Audio/Time code/Sub ID can be separately insert recorded. Assemble/insert editing, as well as, the recording of Time code on previously recorded tape is possible using various editors.

20. TIME CODE READY (Time Code Record Ready) key

Time code ready is switched on or off using this key. In the NORMAL mode, EDIT MODE key = Off, AUDIO READY is simultaneously switched on or off. Both the AUDIO READY and TIME CODE READY LEDs will be lit.

For details on:

Recording, please refer to page 36.

21. TIME CODE INPUT key

Pressing this key will cause the D-20B to switch between Time code input and Repro. Each condition is indicated by the TIME CODE INPUT LED as follows:

LED	MODE
ON	Time Code Input Monitor
OFF	Time Code Repro Monitor
BLINK	Record or Rehearsal Monitor

Switching of TIME CODE INPUT/REPRO alternates with each press of this key.

In the RECORD or REHEARSAL INPUT MONITOR mode, REPRO MONITOR will automatically switch to INPUT MONITOR when TIME

CODE RECORD or REHEARSAL REC is entered.

< Note >

When SETUP mode "E6-01" (Time Code Monitor Select) is set in the generator, TIME CODE OUT if the INPUT LED is lit or blinking, will be the GENERATOR TIME .

22. SET UP (Set Up) key

This key switches on or off the SET UP DATA input mode. Switching on or off alternates with each press of the key.

LED	MODE
OFF	Normal operating mode
BLINK	This is the SET UP DATA mode.
	"E*-***" will appear in the meter display and data check or set is possible by the▲ , ▼ keys.

For details on:

Set Up Menu, please refer to page 55 ~ 60.

< Note >

SET UP mode is alternately entered and exited with each press of the SET UP key. Also, the set up data will be stored even if the power is switched ON/OFF.

23. PRO R-TIME (Pro R-time) LED

This LED will indicate the PRO R-time information as follows:

LED	PRO R-time Status
OFF	PRO R-time is not being recorded. (If Time code is being reproduced, it is a different format).
BLINK	Indicates PRO R-time is being recorded. (If Time code is being reproduced, it is a different format).
ON	Indicates that PRO R-time is selected and that time code is being output.

24. DEW LED

This LED will blink if there is any moisture or condensation on the head drum. If this LED is blinking, a tape cannot be inserted into the D-20B. If there is a tape in the machine and condensation is detected, the LED will blink and all functions will stop until this condensation has evaporated; that is, if the transport is in operation and moisture is detected, the DEW LED will blink and the transport will enter the STOP mode. If this condition is encountered, leave the power on as a built in heater is activated when this LED is lit. When the condensation is evaporated, the LED will extinguish. You may then resume operation.

25. CLOCK LOCK LED

If the D-20B is operating by an external clock (EXT. SYNC. DIGITAL INPUT), whether this clock is being utilized or not is determined and the status is indicated by the CLOCK LOCK LED as below. This LED does not determine whether it is in sync with the external signal. It is lit when the D-20B is operating by the internal clock.

Input mode \ Clock	Clock			Lock Utilized
	Suitable	Unsuitable	No Input	
DIGITAL IN.	ON	Fast BLINK	Fast BLINK	----
EXT. SYNC	ON	Fast BLINK	OFF	Slow BLINK

26. EMPHASIS switch [ON/OFF]

26a. EMPHASIS LED

When recording from the analog input, this switch turns the emphasis circuit on and off. When emphasis is activated, the LED will be lit.

When recording from the digital input and during playback, the position of the switch has no effect. De-emphasis during playback is chosen automatically. If the emphasis condition of the signal differs from the switch condition, the LED will blink..

27. PCM CHECK LEDs [COR/ERR]

This LED monitors the tape playback audio signal and the sub data error status. At simultaneous record/playback in the normal mode, error status of record/playback can also be monitored. The two LEDs will be lit when a blank tape is played back.

LED	Playback Status
All extinguished COR (green) lit	Indicates correct playback. Slight error is occurring but error correction is successfully restoring data.
COR (green), ERR (red) are lit	There is excess error and data is being interpolated or muted. Head cleaning, etc. is needed.

28. TIME CODE LEDs [NORM LEVEL/ERR]

This LED monitors the input or output time code signals. Monitoring is in correlation to the **TIME CODE** input key [21].

LED	Time Code Signal
NORMLEVEL (green) is lit.	Suitable status of the time code signal.
ERR (red) is lit	Time code signal format is unsuitable. It is determining the non-time code sync signal is abnormal.

29. SAMPLING FREQUENCY Switch [44.1kHz]

29a. SAMPLING FREQUENCY LEDs [48kHz]

The **SAMPLING FREQUENCY** switch selects either 44.1 kHz or 48 kHz. The **SAMPLING FREQUENCY** LEDs indicate sampling frequency during playback mode. If the sampling frequency of the signal read from the tape differs from the switch position, the LEDs will blink and no audio signal is output.

Depending on the digital switch settings of the D-20B (for broadcasting, studio or consumer use), the action of the LEDs in the **DIGITAL IN** mode differs.

< Notes >

During digital input (**INPUT** switch [31] = **DIGITAL**), if the input sampling frequency and this switch do not match, the signal, as a rule, will not be accepted (meter display **DIGITAL INPUT** will not be lit). However, even though the digital input and this switch do not match, it often accepts the signal in sync with the input clock. In such a case, the digital interface status will be given priority for AES/EBU and sampling frequency of this unit (D-20B) will be changed. Since the sampling frequency will differ from that of the D-20B switch, the LED will blink. Because the D-20B will not read

the sampling frequency status in the case of consumer use format, it will record in the variable speed mode in accordance to the sampling frequency set by the D-20B's switch. In addition, since the status is not read, the LED will not blink a warning.

30. REMOTE switch [REMOTE/LOCAL]

This switch selects either the control signal from the transport and function keys on the main unit panel, or the control signal from the main unit rear panel RS-422A DATA COM.

Switch	Operation
REMOTE	Control by DATA COM RS-422A and ACCESSORY 1 (20 pin parallel) is possible. All operation from the main unit transport and function keys are not possible (except for the toggle switch). Therefore, this can be used for panel control locking. < Note > Control is possible from both DATA COM RS-422A and the main unit by switching on digital switch B-1.
LOCAL	Panel key control from the D-20B main unit and ACCESSORY 1 is possible (Control by DATA COM RS-422A is not possible. However, request for status only is possible).

31. INPUT switch [DIGITAL/ANALOG]

This switch selects either the DIGITAL or ANALOG input. When the digital input is selected and a correctly chosen digital audio signal is supplied at the input, the indication **DIGITAL INPUT** appears on the meter display. To learn more about the digital audio interface, please refer to Appendix.

32. CLOCK switch [EXT/INT]

This switch selects either the internal clock [INT] or external sync [EXT].

Switch	Operation
EXT	The D-20B will enter external sync. operation. However, should no external sync. signal be input, it automatically changes to internal clock operation and CLOCK LOCK LED [25] will extinguish. In the case of video sync., it requires about two minutes from input of the video signal until the D-20B will synchronize to the clock. During this time, CLOCK LOCK LED [25] will slow blink (upon completing sync., the LED changes to a constant light). When an external signal that is impossible to synchronize is input, the CLOCK LOCK LED [25] will digital inclock is not used, set this switch to EXT. In this case, if no signal is present, it will be digital input in the INT mode. However, the CLOCK LOCK LED will be extinguished.
INT	D-20B will operate with the internal clock. However, if it is switched to DIGITAL INPUT ([31] = DIGITAL), the D-20B will automatically change to digital clock in sync mode.

33. EXT REF Switch [VIDEO/WORD]

When the CLOCK switch [32] is to EXT., either the VIDEO CLOCK sync. or WORD CLOCK sync. may be selected by this switch.

Switch	Rear Panel Input Connector(EXT SYNCconnector)
VIDEO	For VIDEO CLOCK sync. VIDEO INPUT [47] must be selected for the rear panel input connector.
WORD	For WORD CLOCK sync. WORD INPUT [47] must be selected for the rear panel input selector .

< Note >

There are the composite/frame pulse and field pulse type VIDEO CLOCKS. These can be selected by digital switch A. Please refer to the item "Mode Select Digital Switch A" for details.

34. T/C REC MONITOR Switch [REPRO/INPUT]

When recording time code or at rehearsal in the edit mode (EDIT MODE [19] = ON), this switch can select the REPRO MONITOR automatically or, otherwise, to INPUT MONITOR.

Switch	Function
REPRO	It will automatically switch from REPRO to INPUT during record or rehearsal of the time code. The previously recorded time code signal is played back and output to the TIME CODE OUTPUT [44]. This is used to rewrite subsequently recorded time code in sync. with the time code on the tape. The input signal is output to the TIME CODE OUTPUT by pressing the TIME CODE INPUT key [21].
INPUT	During record or rehearsal of the time code, it will automatically switch from REPRO to INPUT.

35. INPUT LEVEL switch [UNCAL/CAL]

35a. INPUT UNCAL LED

This switch selects the level of the analog input signal, calibrated [CAL] or uncalibrated [UNCAL]. When the UNCAL position is chosen the UNCAL LED will light. In the CAL position an input signal level of +4 dBu corresponds to a level meter indication of -18 dB below the full-scale point.

36. INPUT LEVEL control

This control adjusts the analog input signal level when the INPUT LEVEL switch [35] is set to UNCAL. This control changes channel 1 (L) and 2 (R) simultaneously.

37. INPUT BALANCE control

This control adjusts the balance between the two channels when the INPUT LEVEL switch is set to UNCAL.

38. PHONES jack and control

Stereo headphone jack and level control.

39. DISPLAY key

Non-shift mode: By pressing this key, the display counter indication can be switched through program number [PNO], A-time [ABS], and tape speed deviation [SPEED]. During this process, each LED for P NO/ERR, ABS/R-TIME, and SPEED/GEN will be lit.

Shift mode: By pressing this key, the display counter indication may be switched to error flag [ERR], R-time [R-TIME], and generator time [GEN]. During this process, each LED for P NO/ERR, ABS/R-TIME, and SPEED/GEN will blink.

< Notes >

Non shift Press the **DISPLAY** key only.

shift Set the **SHIFT** key [8] ON (LED is lit), then press the **DISPLAY** key.

To exit from the **SHIFT** mode, press **SHIFT** key [8] again, and then the **DISPLAY** key.

Please refer to DISPLAY OPERATION on page 44 ~ 44 for details.

LED	STATE OF LED	CONTENT OF DISPLAY
P NO/ERR	ON	Indicates program number
	BLINK	Displays ERROR flag
ABS/R-Time	ON	Indicates time on A-time
	BLINK	Indicates R-TIME (PRO R-time) or pseudo A-time
SPEED/GEN	ON	Indicates present VARI SPEED
	BLINK	Indicates GENERATOR TIME (PRO R-time)

REAR PANEL**Figure 10**

Rear panel view

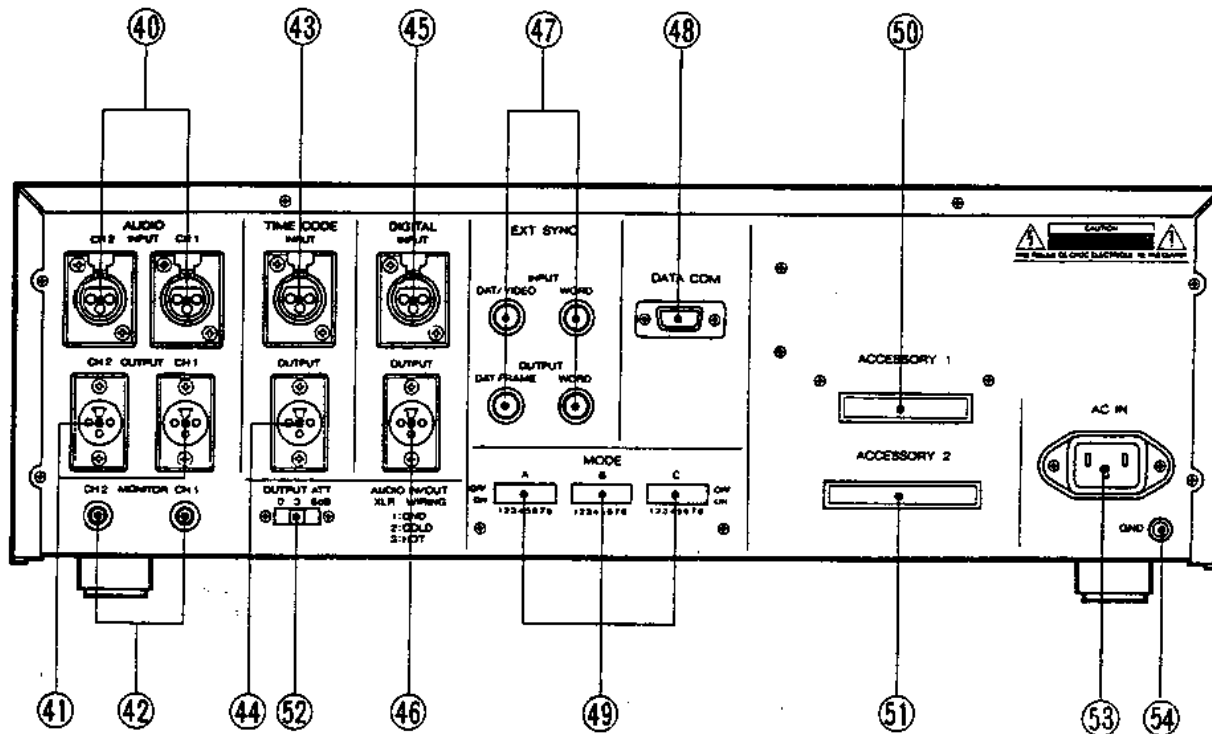
**40. AUDIO INPUT connectors (CH1,CH2)**

Balanced input connectors (XLR 3-31) for analog signal input.

41. AUDIO OUTPUT connectors (CH1,CH2)

Balanced output connectors (XLR 3-32) for analog signal output.

42. MONITOR jacks (CH1,CH2)

Unbalanced output connectors (1/4 inch phone jacks) for analog signal output.

43. TIME CODE INPUT connector

Balanced input connector (XLR 3-31) for input of SMPTE/EBU time code signals.

44. TIME CODE OUTPUT connector

Balanced output connector (XLR 3-32) for output of SMPTE/EBU time code signals.

45. DIGITAL INPUT connector

Balanced input connector (XLR 3-31) for digital signal input.

46. DIGITAL OUTPUT connector

Balanced output connector (XLR 3-32) for digital signal output.

47. EXT SYNC connector

INPUT	DAT/VIDEO	Sync signal (DAT frame, composite video, video frame, video field, etc.) input.
	WORD	WORD SYNC signal is input.
OUTPUT	DAT FRAME	DAT frame signal is output.
	WORD	WORD SYNC is output.

< Note >

When synchronizing two D-20Bs, sync operation of word clock accuracy is made possible by parallel use of DAT frame signal and word sync signal. Please refer to page 62~75.

48. DATA COM connector

9-pin data communication connector (RS-422A) will be corresponded to SONY 9 PIN PROTOCOL.

And also this connector will be used for the FOSTEX 8320 REMOTE CONTROL UNIT.

49. MODE select digital switches

These switches control settings such as the frame frequency and synchronization mode.

Down position is ON and up position is OFF.

The setting of these switches is read only once when the power is switched on. Change these settings while the unit is turned off, or turn the unit off and on again after changing the position of the switch.

For detail on:

Setting the MODE Select Digital Switches, please refer to page 28 ~ 33.

50. ACCESSORY 1 connector

Parallel remote control connector for use with the Fostex 4030 synchronizer.

Please refer to page 62~75.

51. ACCESSORY 2 connector

This is the multi-directional bus used for full digital copy including the sub-code.

Please refer to page 76~78.

52. OUTPUT ATT (Output attenuator)[0,3, 6dB]

Signals at AUDIO OUTPUT (XLR 3-32 OUT) can be attenuated in three steps (0 dB, 3 dB, 6 dB by a switch). Reference output levels are +4 dBu, +1 dBu, and -2 dBu each.

53. AC IN connector

54. GND terminal (Ground terminal)

Summary

We hope the previous section has answered any questions you may have had about the control layout of the D-20B. If you haven't already done so, now would be a good time to install your new machine and power up. The following is written on the assumption that you are operating your D-20B in the configuration for which you purchased it.

Section 4.

SET UP**1. Location**

The D-20B may be either rack mounted using the flanges provided or as a stand alone unit. The main idea in any installation is that there is ample ventilation to the recorder; be sure the top and bottom are unobstructed so that adequate air flow is possible. As with all electric devices, it is important to keep the D-20B away from heat sources, direct sunlight and dampness. The Fostex 8320 REMOTE CONTROL UNIT is also an excellent option if the D-20B is rack mounted at a distance from your console.

2. Connections

The best connections with any recording equipment are those of minimum length using the highest quality cable available. Be sure to route your cables away from AC lines to avoid extraneous hum and noise. Use only high quality audio cable with tightly braided shields, multi-strand center conductors and low internal capacitance. Audio, time code and digital signals to and from the D-20B are handled by XLR cannon connectors. The monitor jacks use standard quarter inch phone plugs for each channel. For sync connection use cables equipped with BNC connectors (TTL level). The data communication cable is a nine-pin cable of the RS-422A standard. For accessory connection (e.g. Fostex 4030 synchronizer, etc.) use the specified flat cables with 20 pin and 30 pin connectors respectively. Make sure all connections are tight and secure before switching on the D-20B.

**3. Setting the Mode Select Digital Switches
(rear panel)**

These switches are set to adjust your D-20B for your own personal requirements. A switch is ON in the down position and OFF in the up position.

The D-20B reads these settings only once during initial "power on" after they have been set. Change the settings when the recorder is off or turn the unit off and on again after changing any settings of the digital switch panel. The factory settings are shown as follows.

100/120 V version

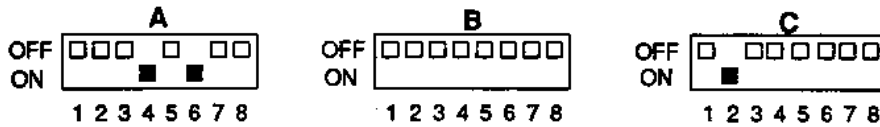

29.97 drop frame composite mode, lock signal of 4030 synchronizer is disregarded.

220/240 V version

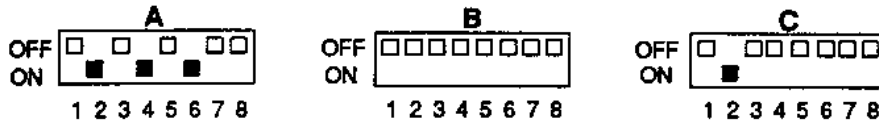

25 frame composite mode, lock signal of 4030 synchronizer is disregarded.

< Note >

Be sure to set the mode select digital switches correctly according to the chart. Correct operation cannot be expected if ON/OFF settings are not as specified.

3-1. Mode select digital switch A

Mode select digital switch A								Function	
Switch number									
1	2	3	4	5	6	7	8		
OFF	OFF						OFF	29.97 drop	Set up the video frame of the time code and external sync frame.
OFF	OFF						ON	29.97 non-drop	
ON	OFF							30	
OFF	ON							25	
ON	ON							24	
		OFF	OFF					Frame sync	Set up the sync signal type of video.
		ON	OFF					Field sync	
		OFF	ON					Compositive sync	
		ON	ON					Unused	
				ON				Model 4030 control mode 1	*1
				OFF				Model 4030 control mode 2	*1
					ON			Model 4030 chase lock mode 1	*1
					OFF			Model 4030 chase lock mode 2	*1
						OFF		Will not sync with DAT frame	*2
						ON		will sync with DAT frame from another D-20B	*2

* 1. When the D-20B is to be used as the slave in combination with a Fostex 4030 synchronizer (clock by external sync mode. **CLOCK** switch at EXT or digital input.), the following operation can be selected by setting digital switches A-5 and A-6.

Function of Digital Switches A-5 and A-6

A-5 : ON (Model 4030 control mode 1)

At word sync and digital input, D-20B can accept the 9.6 kHz control signal from the Fostex 4030 synchronizer and is varispeed controlled by that signal.

When it is being varispeed controlled, the D-20B clock will be by internal clock. Furthermore, during input of digital signals, the audio signal of the recorder is also switched to analog input.

A-5 : OFF (Model 4030 control mode 2)

At word sync and digital input, the D-20B will not accept the 9.6 kHz control signal.

Use this setting for word sync and digital input when not using in combination with a 4030 synchronizer.

A-6 : ON (Model 4030 chase lock mode 2)

During control of the D-20B in varispeed by the 9.6 kHz control signal from the 4030 synchronizer, if the D-20B is being operated by the EXT sync and digital input, it will ignore the lock tally signal received from the 4030 and continue operation in varispeed.

This mode is effective when the time code clock on the tape does not match with that of the audio sample, or if there is an interruption in the sync signal of the master.

A-6 : OFF (Model 4030 chase lock mode 2)

At EXT sync and digital input, the D-20B varispeed operation by the 9.6 kHz control signal is stopped upon receiving the lock tally signal from the 4030 when the D-20B is being controlled in varispeed by the 9.6 kHz control signal from the 4030 synchronizer.

Because of this, jitter (fluctuation of the 9.6 kHz control signal) resulting from phase adjusting after becoming locked, can be prevented.

Setting Example

Example 1: Digital input (INPUT switch selects DIGITAL)

- * Digital switch A-5, A-6: Either ON or OFF is O.K.

This unit operates as the slave. This unit is controlled by the 9.6 kHz control signal and locks to the digital input 0 seconds after receiving the lock tally signal from the 4030. Before locking, this equipment operates by the internal clock.

Example 2: Word sync (INPUT switch selects ANALOG)

- * Set digital switch A-5 to ON, A-6 is OFF.

This operates as the slave in the same way as Example 1.

Example 3: Video sync (INPUT switch selects ANALOG)

- * Set digital switch A-5 to either ON or OFF, A-6 to OFF.

This operates as the slave in the same way as Example 1.

- * Set digital switch A-5 to either ON or OFF, A-6 to ON.

This unit will not accept lock tally even though it is received from the 4030. It is under full control of the 9.6 kHz control signal. Use this mode if there is any danger of instantaneous cutoff of the master video signal, such as from a video disc player.

- * 2. Used for DAT frame sync of two D-20B recorders.

1. DAT frame sync by word clock.

The master side D-20B WORD CLOCK and DAT FRAME outputs are applied to the slave side WORD CLOCK and VIDEO/DAT FRAME signal inputs. Switch on the slave side digital switch A-7, set the front panel CLOCK switch [32] to EXT, and the EXT REF switch [33] to WORD.

2. DAT frame sync by DIGITAL IN.

Connect the master side model D-20B DIGITAL OUT and DAT FRAME outputs to the slave side DIGITAL IN and VIDEO/DAT FRAME signal inputs. Switch on the slave side digital switch A-7 and set the front panel INPUT switch [31] to DIGITAL.

3-2. Mode select digital switch B

Mode select digital switch B								Function
Switch number								
1	2	3	4	5	6	7	8	
OFF								Rem-Con.panel locking
ON								Rem.Con/Main Unit control possible
		OFF						Chase mode 1 *3
		ON						Chase mode 2 *3
			OFF					Always set to OFF
				ON				*4 Consumer use format
				OFF				AES/EBU format
	OFF				OFF			Always set to OFF
						OFF		For adjustment of serbo. Always set to OFF.
							OFF	Always set to OFF.

* 3. Chase mode

Chase Mode 1.

When CHASE ON is entered by the main unit **CHASE** key [10], CHASE will be ended at the moment sync. locks with the reference time code. Therefore, even though lock is disengaged, it will not enter the chase operation again.

Chase Mode 2.

When CHASE ON is entered by the main unit **CHASE** key [10], it will continue to chase even if chase lock is accomplished but later becomes disengaged. To end chase operation, press the **STOP** button [4].

Please refer to page 50.

< Note >

This digital switch setting has no relation to the RS-422A chase control operating mode.

- * 4. At input of a digital signal, the Consumer Use Format and AES/EBU Format are automatically identified. In the case of the consumer format output, even though the signal sampling frequency is 48 kHz, the output signal status sampling frequency bit number is fixed at 44.1 kHz (by nature of the LSI). For this reason, if the receiving end is discriminating the channel status, it may not accept the digital output.

3-3. Mode select digital switch C

Mode select digital switch C								Function
Switch number								
1	2	3	4	5	6	7	8	
OFF		OFF	OFF		OFF	OFF	OFF	Always set to OFF
	ON							SONY 9 PIN PROTOCOL (Always set to ON)
				OFF				SUB CODE COPY SLAVE MODE *5
				ON				SUB CODE COPY MASTER MODE *5

*5. Please refer to page 76 ~ 78.

< Note >

Be careful to set this mode select digital switch in accordance to the list.

Mis-operation or breakdowns could occur if these switches are set incorrectly.

Section 5. RECORDING

The D-20B can be operated in much the same way as a two channel reel-to-reel master recorder with a center track. As with a sophisticated analog master recorder, audio signal confidential (simultaneous) monitor, punch in/out capability, independent time code recording, editing, etc. can all be done on the D-20B. It provides two operational modes: NORMAL mode (leading heads are used for recording and trailing heads for playback), and EDIT mode (head allocation is reversed). The following will explain the purpose of the various modes.

Record Mode	Type of Signal	Objective
Normal Mode	Simultaneous Audio and Time Code	*Simultaneous tape monitor at recording. *Reuse of recorded tape. *Recording on virgin tape.
	Audio	*Assemble insert editing using a video editor, etc.
Edit Mode	Time Code	*After recording and refresh of Time Code.
	Simultaneous Audio and Time Code	*Assemble editing on virgin or recorded tape using a video editor, etc.

Basic connections

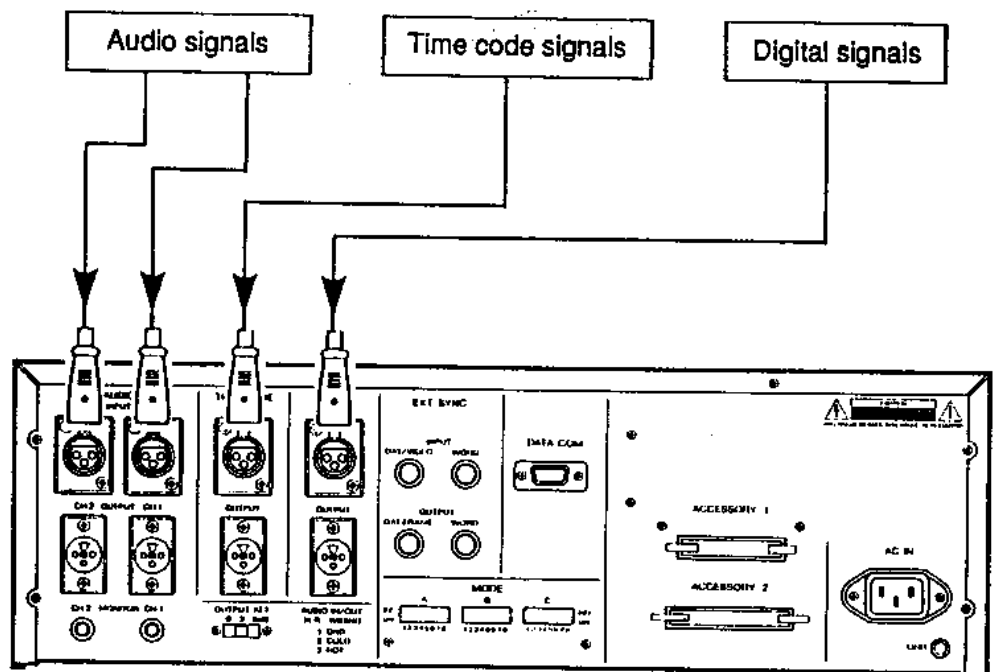

1. Recording Analog Sources

■ Normal Mode

When recording is carried out in the normal mode, all information present on the tape (PCM, sub data and ATF data) is overwritten. Use this mode for recording on blank tape or for reusing a tape which contains unwanted material. Be sure to rewind any used tape to the beginning for recording.

Switch settings :

- **CLOCK** switch [32]* : INT
- **SAMPLING FREQUENCY** Switch [29] : 44.1 or 48 kHz
- **INPUT** switch [31] : ANALOG
- **EMPHASIS** switch [26] : Appropriate setting

* Set the **CLOCK** switch to INT if there is to be no external sync signal.

< Notes >

- When loading the tape, if the tape is loaded in an unrecorded area, the D-20B will automatically search for the end of the prerecorded section.
- In the DAT standard, it recommends recording A-time from the beginning of the tape. If a silent section is necessary before the start of recording, it is recommended to operate mute record in this section.

Operation :

1. Press the **EDIT MODE** key [19] OFF (LED will not light).
2. Press the **AUDIO INPUT** key [18] ON (LED will light) and check the input level. The input level can be monitored this way.
3. Press the **AUDIO READY** key [17] ON (LED will light).
4. Press The **RECORD** [3] and **PLAY** [5] buttons together to start recording. Pressing the **AUDIO INPUT** key [18] ON during recording will allow confidential monitoring (LED will not light).

<Notes>

When playing back a tape on which a copy inhibiting code was recorded, the code is output at the digital audio interface of the consumer use version only.

■ Edit Mode

This is the mode used for doing seamless punch in/punch out recording only audio data. *Please refer to page 39, 40.*

Switch settings :

Settings are the same as for Normal Mode.

Operation :

1. Press the **EDIT MODE** key [19] ON (LED will light).
2. Switch on the **AUDIO INPUT** key [18] and check the input level, etc.
3. Select and set **REC READY** for the following applications:

- **Insert recording for audio data only**

If the audio data only must be rewritten, switch on the **AUDIO READY** key. The **AUDIO READY LED** will light; be sure the **TIME CODE READY LED** is extinguished. During recording in this mode, only audiodata will be recorded, and the sub data will not be recorded. Because of this, simultaneous recording of ID such as a start ID, etc. cannot be done this way.

- **Assemble recording for rewriting all track data**

If it necessary to rewrite all data; audio data, sub data, and ATF, or if you must do patch-in recording, switch on the **AUDIO READY** key, and the **TIME CODE READY** key. Check for the **AUDIO READY** and **TIME CODE LED**'s to light. Although this assemble recording resembles normal mode recording, it allows seamless recording by using the punch-in function. The tape, however, cannot be monitored at the same time.

4. Press the **REC** [3] and **PLAY** [5] buttons together to start recording. (For seamless recording by crossfading, it must be entered beforehand in the **PLAY** mode.)

2. Time Code Recording

■ Normal Mode

Recording principles are the same as for recording from analog sources. The D-20B mode select digital switch A-1 and A-2 must be adjusted to the frame rate of the external time code generator. At the same time, the audio data will be mute recorded automatically.

Switch settings :

- Set the mode select digital switch [49]A-1 ~ A-4 to match the frame rate of the time code. *Please refer to page 29.*
- **TC REC MONITOR** switch [34] : INPUT
- **CLOCK** switch [32]* : EXT

*Set the **CLOCK** switch to INT if there is to be no external sync signal.

Operation :

1. Press the **EDIT MODE** key [19] OFF.
2. Set the **TIME CODE INPUT** key [21] to ON and verify that the green **TIME CODE LED** is lit. If the red LED is lit, check whether the setting of the mode select digital switch A matches the frame rate of the time code.
3. Set the **TIME CODE READY** key [20] to ON. The **TIME CODE READY LED** will light and the **AUDIO READY LED** will light. **AUDIO READY LED** only will blink to indicate the audio mute recording condition.
4. Press the **RECORD** [3] and **PLAY** [5] buttons together to start recording. By setting the **TIME CODE INPUT** key [21] to ON during recording, confidential monitor can be carried out. Also **TIME CODE LED** [28] is entered confidential monitor.

*Please refer to the <Set Up Data> E2-**, E3-**, on page 57.*

■ Edit Mode

Use this mode to add time codes to an existing recording or to partially alter time codes. Pre-recorded sub data will be preserved. The following two cases are possible when recording time codes in the edit mode.

(1) When Time codes are recorded on the tape section which already contains audio information, only the sub data area is rewritten, but Audio data and ATF data remain unchanged.

(2) When Time code data is recorded on previously unused tape or tape section, all data; audio data, sub data and ATF data are rewritten. The audio data is recorded with a digitally muted signal.

Several frames are not recorded during the Interval when the recorder is changing from re-writing sub data to the recording mode for all data. Because of this, there will be a TC and A- time discontinuity.

< Note >

The D-20B distinguishes between these two cases automatically.

Switch settings :

Settings are the same as for Normal Mode.

Operation:

When the **EDIT MODE** key [19] is switched On (LED is lit), the other keys and buttons will operate in the same way as the Normal Mode. However, the **AUDIO READY** LED will be extinguished.

Follow the previous procedures 1 and 2 when simultaneously recording audio and time codes in either the normal or edit mode.

3. Mute Recording of Audio

In either Normal or Edit modes to enter REC MUTE, let the **AUDIO READY** LED blink, then enter the RECORD mode by pressing the **RECORD** [3] and **PLAY** [5] buttons together.

Operation.

Each time the **AUDIO READY** key [17] is pressed, while in the Stop mode, the **AUDIO READY** LED and **TIME CODE READY** LED will alternately switch between On and Off. During this process, to enter REC MUTE, switch On the **SHIFT READY** [8] while the LED is lit, then switch On the **AUDIO READY** key [17] (**AUDIO READY** LED only will blink to indicate the REC MUTE mode).

To enter REC MUTE while in the Record mode, in the same way as above, switch On the **SHIFT** [8] and **AUDIO READY** [17] keys at which time the **AUDIO READY** LED will blink and enter the REC MUTE mode.

While in REC MUTE, press the **AUDIO READY** key [17] again and it will return to normal recording (**AUDIO READY** LED will change from blink to constant light).

4. Recording Digital Sources

The following is for either AES/EBU or consumer use format.

Switch settings :

- **INPUT** switch [31] **DIGITAL***
 - Other settings are the same as Analog Sources Recording.
- * Digital signal input will cause "**DIGITAL INPUT**" to light on the display.

< Note >

Either AES/EBU or consumer use format is selected automatically.

Operation :

Same as for analog sources recording.

5. Punch-in/Punch-out Recording

Punch-in/punch-out recording can be done during playback in the edit mode. The audio signal crossfade time is 10 msec.

Punch-in operation :

1. Press the **EDIT MODE** key [19] ON (EDIT MODE LED will light).
2. For audio punch-in, press the **AUDIO READY** key [17]. For time code punch-in, press the **TIME CODE READY** key [20]. The respective LED will light.
3. Press the **PLAY** button [5]. The **PLAY** button will light. The sound from the tape can be monitored in this way.
4. Pressing the **PLAY** button [5] and the **RECORD** button [3] at the same time during playback sets the D-20B in the record mode (punch-in performed). The **PLAY** and **RECORD** buttons will be lit.

Punch-out operation :

While recording in the above manner, press the **PLAY** button [5] only. This will stop the recording mode (punch-out performed).

Please refer to page 10.

< Note >

The D-20B plays back the signal, processes it for the same amount of time it takes to travel, and rerecords it. This ensures the information is written in the same location as that which has been erased. See illustration below. Punch in/out editing is normally automatically executed by the DES system steps 2 through 4 using a video editor or a Fostex 4030.

Please refer to application examples, page 62 ~ 75.

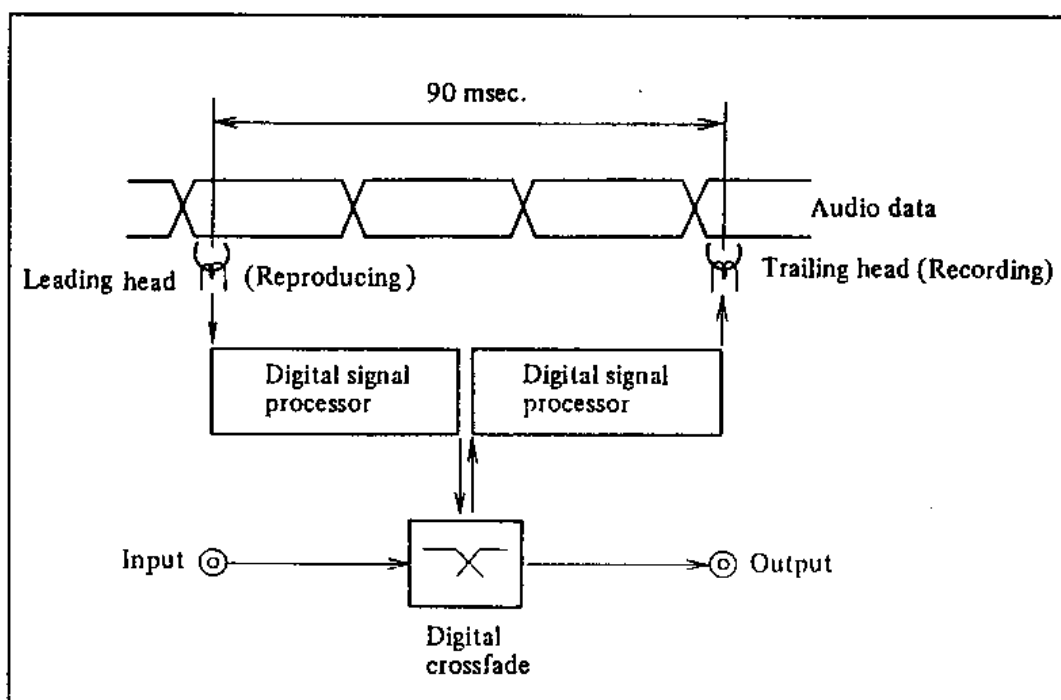
**< Note >**

In order to maintain continuity of PCM, seamless recording is executed by a 10 msec. digital crossfade.

Section 6.

Function and Operating of the Keys**1. Display Counter Messages**

Besides showing program number, time and variable speed information, the numeric counter in the display panel can also show the following three messages:

OPEN	Unit is turned on and cassette was ejected. Currently no tape is inserted.
BE91 n	A virgin cassette was loaded or the tape in the inserted cassette was fully rewound to the beginning.
End	The tape has been fully wound in the forward direction.
En - * *	SYSTEM ERROR is occurring. Should the recorder not return to normal upon switching ON/OFF the power switch, please contact our service department.

A more detailed description of the **DISPLAY** key functions follow below.

2. Display Key Operation

This section will explain information that is shown on the display by switching on the display key [39].

When the **display** key [39] is pressed in the non-shifting mode, displays of P.No, ABS, and SPEED (in that order) will be switched successively with each press of the key. If, during the display of P.No., the **HOLD/CUE** key [9] is pressed, the D-20B will enter PROG NO MEM EDIT. At ABS, it will enter ABS MEM EDIT. Additionally, when the display key is pressed in the shift mode (**SHIFT** key [8] is ON), the DISPLAY LEDs will blink to indicate ERR. FLAG, R-TIME, and GEN TIME. If the **HOLD/CUE** key is pressed at each display, it will enter R-TIME MEM EDIT, and GEN TIME MEM EDIT.

2-1. Display Indications at Non-shift

The ● symbol indicates a lighted LED.

1. Program Number Display (PROG. NO).

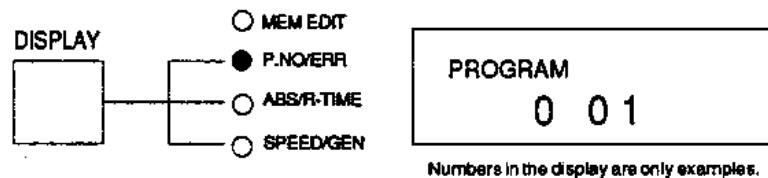

If a tape without a program number is played back, " — — — " will be displayed.

* Program numbers will not be recorded at independent use of this unit. However, 001 will automatically be recorded at the head of the tape.

* If the **HOLD/CUE** key [9] is pressed at the above PNo display, PROG NO MEM EDIT will be displayed as below:

1-1. PROG NO MEM EDIT display (Display edit mode of PROG NO).

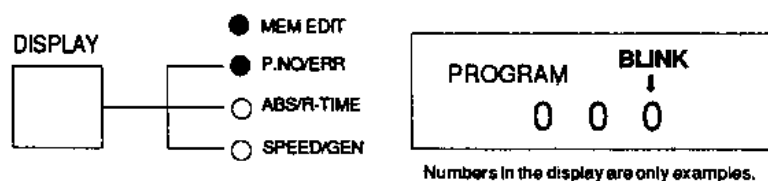

* Blink point on the display alternates with each press of the **HOLD/CUE** key [9].

2. ABS Display (Displays the present tape time).

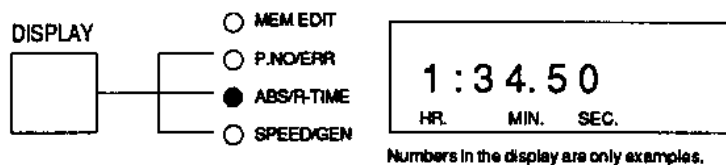

This is based on A-time that is recorded on the tape.

When a tape without an A-time recording is played back, " _ _ _ " will be displayed.

If the HOLD/CUE key [9] is pressed at the ABS display, ABS MEMEDIT will be displayed as follows:

2-1. Display of ABS MEMEDIT (Displays editing status of time).

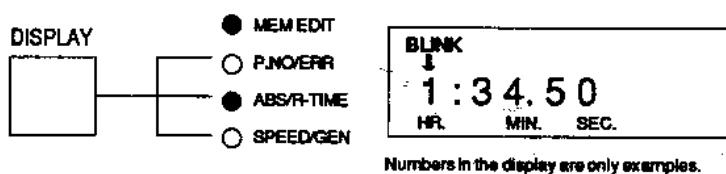

* Blink point on the display alternates with each press of the HOLD/CUE [9] key.

3. Display of SPEED (Present tape speed is referenced to normal speed "0" is indicated in %).

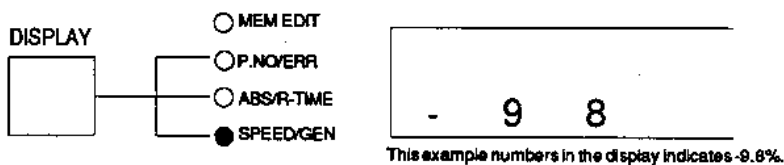

2-2. Display at shift

The ● symbol indicates lighted LEDs, and ○ the blinking LEDs.

1. Display of ERR FLAG (Displays the error flag number).

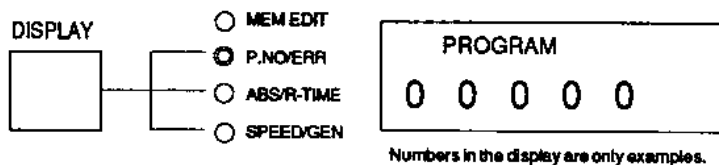

* The error flag is displayed when PNO/ERR of the display select LED is blinking. If PNO/ERR is already lit, change it to blink by pressing the SHIFT key [8] and then the DISPLAY key [39].

The total number of errors in the ERROR FLAG will be:

(C1 SUB 32 errors + C1 MAIN 256 errors) X 8 frames = 2304 errors.

2. Display of PRO R-time (Displays time code of the IEC format).

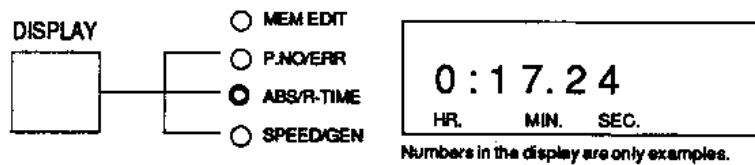

* PRO R-time is displayed when the display select LED is blinking. If PRO R-time is not recorded, pseudo time will be displayed.

* As PRO R-time is the time display before conversion to the IEC time code (SMPTE/EBU), when it is converted to 29.97 non-drop frame, an approximate 4 second difference per hour occurs in the time indication between the time code output and PRO R-time.

* Pseudo time is used to approximate the tape position when both A-time and R-time do not exist in the pre-recorded tape. During this procedure, if the **SHIFT** [8] and **DISPLAY** [39] keys are pressed in this order when the display select LED is lit, it will blink and the display will start operating as the counter with this point being 0hr. 00min. 00sec.

* The PRO R-Time display is from 0 to 23 hours. Therefore, time display longer than 10 hours is alternately shown by X10 hours and X1 hours in one HR digit. The short lighting represents the X10 and the long one the X1 hour.

3. Display of GENERATOR TIME (Displays the generator time code).

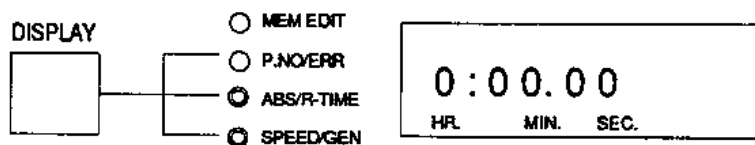

* Generator time code is displayed when the display select LED SPEED/GEN is blinking. If it is already lit, set the LED blinking by pressing the **SHIFT** [8] and **DISPLAY** [39] keys in this order.

* As the GEN display is the time display after conversion to PRO R-time from the IEC time code (SMPTE/EBU), when the 29.97 non-drop frame is being generated, an approximate 4 second difference per hour will occur between indications of the output time code and GEN.

* If the **HOLD/CUE** key [9] is pressed at this time, the display will be GEN TIME MEM EDIT. In this case, the MEM EDIT LED will be lit and the SPEED/GEN LED will blink).

3. Locating by Time

3-1. Locate

Make sure that neither the shift mode nor the MEM EDIT mode are activated (the SHIFT LED and MEM EDIT LED are not lit). Press the **SHIFT** key [8] to cancel the shift mode; press the **DISPLAY** key [39] to cancel the MEMEDIT mode. The table below sums up the various functions of the different locate keys.

<input type="radio"/> LOC 1 <input type="checkbox"/> key ON (LOC 1 LED is lit.)	It will locate to the point entered in memory as LOC 1 and STOP. Upon locating LOC 1 LED is extinguished and the mode cancelled.
<input type="radio"/> P. LOC <input type="checkbox"/> key ON (P. LOC LED is lit.)	It will auto locate to the last point of PLAY/REC or PLAY and STOP. Upon locating, P. LOC LED is extinguished and the mode cancelled.

3-2. Auto Play

Please note that pressing the **PLAY** button [5] before any of the above locate functions will put the D-20B into auto-play. The **PLAY** button will be blinking. Playback will start automatically after the point on the tape has been located. This is an useful feature for a great number of recording and synchronizing situations.

3-3. Changing the Contents of the Locate Memory



Make sure that the shift mode is not activated (see above) and that the display counter is in the time indication mode. Press the **HOLD/ ▶** key [9] to hold the current time indication. The D-20 B will enter the MEM EDIT mode and the MEM EDIT LED will light .

The display will show, for example:

Blink
 ↓
 0 : 3 1 . 5 6
 HR. MIN. SEC.

Pressing the **HOLD** key [9] will cycle the blinking unit from hours >>> minutes >>> seconds. These blinking numbers can be altered using the ▲ key [11] and the ▼ key [10].



Data thus edited can be stored in memory and GEN TIME set as their locate points by pressing the following keys:

<p>○ LOC 1  key ON</p>	<p>The time held is entered in memory as the LOC 1 point and at the same time, the MEM EDIT mode is cancelled (MEM EDIT LED is extinguished).</p>
<p>○ P.LOC  key ON</p>	<p>The time held is entered in memory as the P. LOC point and at the same time, the MEM EDIT LED mode is cancelled. Data, however, will be renewed by entering the REC/PLAY or the PLAY mode.</p>
<p>○ GEN ON  key ON</p>	<p>Time thus held (edited) will be set in the INTERNAL TIME CODE GENERATOR. However, when the GEN ON LED is not lit, if the JAM SYNC LED is blinking by the external time code, the time code input by TAPE JAM is occasionally rewritten. Therefore, data should be set during GEN ON operation.</p>

3-4. Displaying the Contents of the Locate Memory

Press the **SHIFT** key [8] to activate the shift mode. The **SHIFT** LED will light.

Then press one of the keys shown in the table below. Contents will be displayed while the button is held down.

<p>○ LOC 1  key ON</p>	<p>LOC 1 point is indicated.</p>
<p>○ P.LOC  key ON</p>	<p>P. LOC point is indicated.</p>

< Note >

Press the **HOLD** key [9] while in any of the above displays allows alteration of the locate memory contents.

4. Locating by Program Numbers

When the display is in the PROG NO mode, recorded sections on the tape can be located by program number. The D-20B will locate to a spot one second before where the program number is located. This will be verified on the display; the number on the display will be one count lower than the program number located. The D-20B can play back tapes on which program numbers are recorded but it will not record these numbers.

4-1. Locate

Check that the display counter is in the PROG NO mode and that the SHIFT LED is out. Press the LOC 1 key [14]. The program number shown on the display will be located.

4-2. Changing the Displayed Program Number

Check that the display is in the PROG NO mode and that the SHIFT LED is out. Press the HOLD key [9]. This will activate the MEM EDIT mode (MEM EDIT LED lights). The display will show, for example:

If the held program number on the display is...

(Example) This is displayed.

Blinking (Least Significant Digit blinks first.)

PROGRAM

 0 1 5

Pressing the HOLD key [9] in this mode will cycle the blinking digit through ones, tens, hundreds, etc. The blinking number can be increased or decreased using the ▲ [11] and ▼ [10] keys. After changing the program number, press the LOC 1 key [14] to locate the changed program number. Remember, that this function only works with tapes with program numbers that have been prerecorded.

< Note >

Program number cannot be memorized.

5. Blank Search

Any blank portions longer than nine seconds on a partially recorded tape or END-ID will disrupt the A-time (absolute time) information. The blank search function will locate these blank (unrecorded) sections or END-ID. This makes it possible to record on a partially recorded tape while maintaining A-time continuity. For the blank search to work, the unrecorded section must be at least nine seconds long.

5-1. Operation

To find these blank sections, press the **SHIFT** key [8] and then the **BLANK SEARCH** key [11]. The **BLANK SEARCH LED** will light and the D-20B will search for the blank spot using either fast forward or rewind. The D-20B will stop one second before the end of the recorded part of the tape and the **BLANK SEARCH LED** will extinguish.

To cancel the Blank Search mode, press any of the following buttons: **PLAY**, **STOP**, **F. FWD**, **REWIND**.

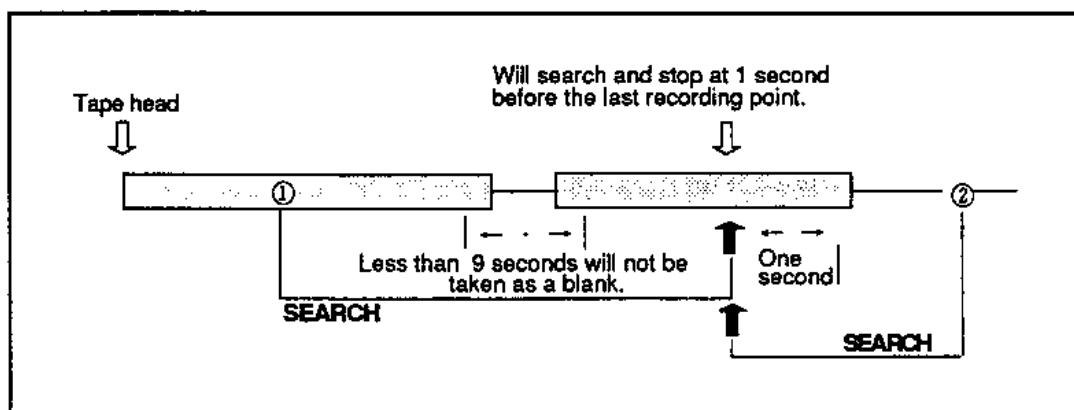

* If blank search was activated in a **recorded section** ①, the D-20B will search in a forward direction and stop at a point one second before the end of the last recorded section.

* If blank search was activated in a **blank section** ②, search will be carried out in a reverse direction until the point one second before the end of the recorded section is located.

* Generally, the blank search function works in a forward direction. That is, once a blank section is recorded, the next blank search operation will always be going in a forward direction.

< Note >

* A recorded section is defined as any section on the tape upon which any

kind of recording (including non signal recording with the rec mute function) was input.

* A blank area is defined as any section on the tape upon which no recording has been input or tape that has been erased by a bulk eraser.

6. Variable Speed Function

The D-20B can vary tape speed, in 0.1% increments, plus or minus ten percent. This is a handy feature for creative effects as well as recording fixed pitch instruments.

6-1. Operation

1. Press the **SHIFT** key [8] (SHIFT LED lights).
2. Press the **VARI SPEED** key [12]. (VARI SPEED LED lights, SHIFT LED is extinguished). The D-20B is now in the varispeed mode. The display will show current speed with "00" being true speed.
3. Press the **▲** key [11] or the **▼** key [10] to change tape speed.
4. To cancel the Vari Speed mode press, first, the **SHIFT** key [8], and then, the **VARI SPEED** key [12]. The display will change to the previous display of Vari Speed mode. The associated LEDs will be extinguished.

< Notes >

* When the speed has been changed, the D-20B memorizes the new setting. It will return to this setting whenever the D-20B is returned to the varispeed mode, even if the main power is turned off. To return to a "00" setting in the varispeed mode, repeat the steps above and set "00" with the **▲** or **▼** keys.

* When the speed is changed during playback, the clock frequency of the digital output also changes. Some equipment may not be able to handle this change correctly.

7. Cueing

During rewind or fast-forward at five times normal playback speed, cueing can be carried out. Cueing is not possible during high speed winding.

7-1. To enter the cueing mode

1. Press the **SHIFT** key [18]. The **SHIFT** LED will light.
2. Press the **CUE/HOLD** key [9]. The **SHIFT** LED will go out and the **CUE** LED will light.
3. To cancel the cueing mode, press the **SHIFT** key [8]. Both LEDs will be lit. Now, press the **CUE/HOLD** key [9]. Both LEDs will go out and you have exited the cue mode.

8. Chase Function

8-1. Operation by the Chase Mode

The D-20B contains the following two chase modes.

Chase Mode 1 Operation

After chase is entered, it is ended at the point where sync is locked once with the time code. Therefore, it will not chase again even though lock is disengaged.

Chase Mode 2 Operation

Even though chase lock is entered once after the Chase Mode is entered, should lock subsequently become disengaged, the D-20B will repeatedly enter the chase mode.

The **STOP** button [4] is pressed to end the chase mode.

< Note >

Using chase lock between different frames such as tape time code (non drop) and reference time code (drop), be careful as the chase operation will become unstable.

Selecting either one of these two chase modes is possible by the main unit rear panel mode select digital switch B-3. Please refer to the list below for setting digital switch B-3.

Set up of Digital Switch	CHASE MODE
Digital Switch B-3 : OFF	CHASE MODE 1
Digital Switch B-3 : ON	CHASE MODE 2

* Refer to the D-20B PROTOCOL for the Chase Mode setting from RS-422A.

8 - 2. Starting Method of Chase Sync

To start chase sync, press the **SHIFT** key [8], and then the **CHASE** key [10]. The **CHASE LED** will blink when the Chase Mode is entered.

8 - 3. Paralell Use of Chase Mode and Sync Play

After completing chase lock, the D-20B will run at standard speed (vari pitch "0"). Therefore, the reference time code and D-20B sampling clock must be synchronized at a certain ratio. If it is not in sync, it will result in a gradual shift in sync from the reference time code. In this case, losing the lock may be held to a minimum by combined use of the set up mode "E5-**" (SYNC PLAY MODE) as "E5-02" (CONTINUOUSLY IN SYNC PLAY) and the Chase Mode. Clock deviation, however, will be within 0.1%. Please refer to Set Up Menu "E5-02".

8 - 4. Method of Ending Chase Sync

To end chase sync, either press the **STOP** button [4] or the **SHIFT** key [8] and **CHASE** key [10] again. The **CHASE LED** will extinguish when the Chase Mode is canceled.

< Note >

Sync accuracy will be within $\pm 300 \mu s$ when chase lock is entered and the **CHASE LED** changes from blinking to constant lighting. Once sync is entered and the **CHASE LED** is lit, it will be extinguished when difference between the reference time code subsequently becomes larger than 10 frames. Therefore, at selection of Chase Mode 2, re-chasing occurs when the difference becomes larger than 10 frames.

Also, when it is switched between the normal and edit mode when it is in lock, it will lock at a difference of about 3 frames.

9. Internal Time Code Generator

The D-20B time code generator may be started using the following methods.

9 - 1. Starting the Internal Time Code Generator

Press the **GEN ON** key [15] while the **GEN ON LED** is extinguished. The **GEN ON LED** will be lit when the generator is started. Also, if the **JAM LED** is blinking, it will also be extinguished.

9 - 2. To Force Jam With the Internal Time Code

When the **GEN ON LED** is extinguished, press the **GEN ON** key [15] while an external time code is input. The **GEN ON LED** will be lit when the generator is started. The **JAM LED** will extinguish if it was blinking.

< Note >

The Force Jam Function.

The Force Jam function reads the time data and timing of the external time code, and when the internal time code generator is once locked to this signal, it will free run accurately even if the external signal is removed.

9 - 3. Stopping the Internal Time Code Generator

Press the **GEN ON** key [15] when the **GEN ON LED** is lit. Because of the jam sync. mode, this will not function if the **JAM LED** is lit.

*** This setting will be stored even if the power is switched off.**

< Note >

When the D-20B is operated by external clock, the generator clock will sync with the external clock. However, phase of the composite signal V-SYNC will not match the generator time code sync signal. Therefore, it cannot be used for recording on time code tracks such as for video, etc.

< Note >

When the vari-pitch and sync play modes are entered, the internal time code speed will also change in proportion as the Model D-20B internal time code generator is synchronized with the **WORD CLOCK**.

10. Jam Sync Function

The Jam Sync function generates a time code successively to the PRO R-time time code written on the tape and records it when the D-20B enters record mode. This is effective mainly in assemble editing using an editor. The following explains the method of starting the Jam Sync contained the D-20B.

10 - 1. Starting Jam Sync

1. Press the **JAM** key [16] once when the **JAM LED** is extinguished. The **JAM LED** will blink if the tape is stopped and will be in the **JAM SYNC READY** state. If the **GEN ON LED** is also on, it will extinguish.

When the tape is played back, the **JAM LED** will blink if **PRO R-Time** is recorded on the tape. The **GEN ON LED** will be lit and the D20-B will enter the playback time code regenerate mode.

2. When **RECORD PLAY** including the recording of **PRO R-Time** is executed, the Jam Sync Time Code generator will operate and both the **JAM** and **GEN ON LED**s will be lit. If the **PRO R-Time** necessary to jam to the tape record starting point is not recorded, generator time of that point will be picked up for count up and be recorded. During the record mode, **GENERATOR TIME PRESET** is possible from the D-20B and through RS-422A.

10 - 2. Ending Jam Sync

Jam sync can be ended by pressing the **JAM** key [16] once when the **JAM LED** is lit or blinking.

*This setting will be stored even if the power is switched off.

(Memo)

Section 7.

SET UP MENU**1. Set up Menu**

The method for setting the Set Up Data upon switching to SET UP mode from the normal operating mode is explained below.

1 - 1. Key Operation for the SET UP Mode

The **SET UP** key [22] is pressed once to switch from the normal mode to the SET UP mode. The extinguished SET UP LED will blink by pressing this key. Using this procedure, the meter display will change to the following indication. The ● symbol indicates the lighted LEDs.

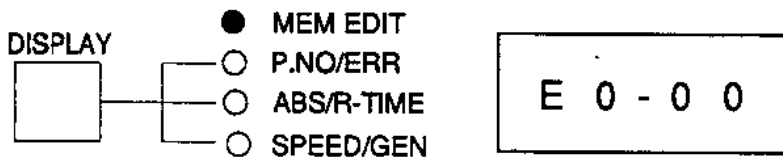
**1 - 2. Setting Up the Set Up Data**

After the above key operation, Set Up Data thus displayed is setup by using the **HOLD/CUE** key [9], **▲**key [11], and the **▼**key [10]. Each key sets the point as shown below.

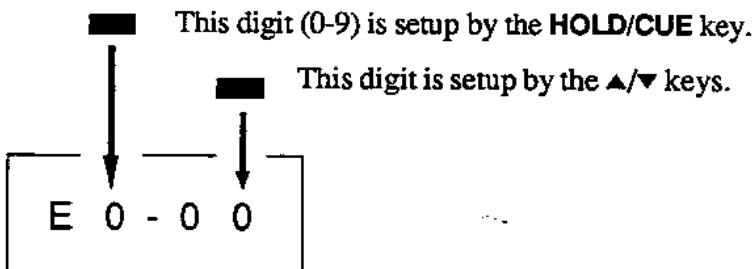
**1 - 3. Exiting the Set Up Mode**

Press the **SET UP** key [22] again to exit the SET UP mode. The SET UP LED will extinguish and the display will change to the previous display of SET UP mode. The setup mode is alternately entered and exited by pressing the **SET UP** key.

*The data stored will be held regardless of power being switched on or off.

< Note >

Please note that operation of this function is not assured if invalid data, i.e., incorrect numbers, are stored.

2. Set Up Data

Details on SET UP Data necessary for using the D-20B is explained in the following. Anyone of the Set Up Data may be setup as needed

This symbol is used to indicate the default option.

2 - 1. E0 - ** : Setting the Editor Type

When connecting to editors and other equipment complying to the SONY 9 PIN PROTOCOL, setup in accordance to the specific type of equipment. In our equipment, the following six types are provided:

Display	Editor type
E0 - 00	RM450, BVU, BVW, BVH, DVR, Model4030
<input type="checkbox"/> E0 - 01	CMX, Grass Valley
E0 - 02	LYNX *1
E0 - 03	BVE - 900, BVE-910, BVE - 9000
E0 - 04	ACE - 25 *2
E0 - 05	Model 4030 (Auxiliary mode) *3

*1. In the FF/REW modes, the D-20B TIME CODE OUT will not output the time code.

*2. Although "E0-04" is the 1 through 16 times speed exclusive AEC-25 mode, when using AEC-25 which can read time code at 100 times speed, set this to "E0-01".

*3. Normally, set this to "E0-00" when using a Fostex 4030 synchronizer. This must, however, be set to "E0-05" if input monitor, and Rehearsal mode from the 4030 cannot be canceled by switches other than REC such as FF/REW.

2 - 2. E1 - ** : Setting the Device Type

This equipment can comply to a wide variety of editors as its emulation mode can be selected from among the following types.

Display	Device type
<input type="checkbox"/> E1 - 00	BVU-800
E1 - 01	FOSTEX DAT *4
E1 - 02	BVH-2000
E1 - 03	BVU-950

*4 DEVICE CODE for FOSTEX DAT are as follows:

h1211F010 : SMPTE

h1211F110 : EBU

2 - 3. E2 - ** : Selecting the time code recording format

Display	FOSTEX format	IEC format
<input type="checkbox"/> E2 - 00	Enable	Enable
E2 - 01	Enable	Disable
E2 - 02	Disable	Enable
E2 - 03	Disable	Disable

2 - 4. E3 - ** : Selecting the playback time code

Display	Time code playback format
<input type="checkbox"/> E3 - 00	PRO R-Time or Fostex format (priority to PRO R-Time)
E3 - 01	Fostex format or PRO R-Time (priority to Fostex format)
E3 - 02	A-time

2 - 5. E4 - ** : Setup of tape length

The pseudo A-time mode uses reel rotation to ascertain the approximate place on the tape. Therefore, it is not as accurate as real time.

Please set the tape range to the type of tape you use.

Please refer to the page 44 for further information on pseudo A-time.

Display	Tape length (minute)
<input type="checkbox"/> E4 - 00	For 120 minute tapes
E4 - 01	For 90 minute tapes
E4 - 02	For 60 minute tapes
E4 - 03	For 46 minute tapes
E4 - 04	For 30 minute tapes

2 - 6. E5 - ** : Setting the sync play function

Setting the sync play function. Sync play is synchronized to external reference time code. The D-20B needs a maximum of five seconds preroll time for synchronization.

Display	Sync play function	
<input type="checkbox"/> E5 - 00	Editor only	*5
E5 - 01	Enters sync play for 5 secs from play	*6
E5 - 02	Continuously in sync play	*7
E5 - 03	OFF	*8

*5 When only a PLAY command from the editor via the RS-422A port (38kbps) is output, the D-20B will sync-play for a maximum of five seconds. When there is no reference time code, the D-20B will synchronize to the current time request command. When there is neither reference time code or current time code request(ex: computer), the D-20B will be unstable. In this case, please set to 2nd mode "E5-03".

*6 All PLAY commands (D-20B, editor, 4030, etc.) will cause the D-20B to enter sync play for a maximum of five seconds. If there is no reference time code, the D-20B cannot entered into sync play mode.

*7 All PLAY command (D-20B, editor, 4030, etc.) will put the D-20B into continuous sync play if there is a reference time code.

*8 The sync play is in OFF mode, when controlling the D-20B by computer via the RS-422A, please set to this mode.

< Note >

After setup to "E5-01" and "E5-02", then entered in the play mode, it will temporarily enter the VARI PITCH mode in some occasion when an external time code is input.

< Note > The reference time code

The reference time code is made by the house sync signal. When sync playing, the D-20B will use only synchronization information of the reference time code. Therefore, the time data are free setting.

2 - 7. E6 - ** : Selecting the time code monitor

The internal TC generator has a Jam Sync function. It functions by reading the time code on the tape and then creates new continuous time code based on this information. This functions only in IEC format.

Select the time code monitor from the list below.

Display	Input monitor
<input type="checkbox"/> E6 - 00	Ext time code monitor
E6 - 01	Internal generator time code monitor

<Note> When in the TIME CODE MONITOR mode under the "E6-01" setting, care must be taken as switching between "NORMAL" and "EDIT" or changing the SAMPLING FREQUENCY mode will result in an error of the GENERATOR TIME CODE output.

2 - 8. E7 - ** : Setting the PAUSE time

Time setting of the releasing time of the pause mode.

Display	Pause mode duration
<input type="checkbox"/> E7 - 00	3 mins
E7 - 01	10 secs
E7 - 02	20 secs
E7 - 03	30 secs
E7 - 04	45 secs
E7 - 05	60 secs
E7 - 06	90 secs
E7 - 07	120 secs
E7 - 08	continuous *9
E7 - 09	150 msec

*9 Care should be exercised when using the continuous setting as excessive stress may be applied to the tape.

2 - 9. E8 - ** : Set Up the Copy Guard Code

Display	Copy Gard
<input type="checkbox"/> E8 - 00	No Copy Gard
E8 - 01	Copy Gard Write
E - 02	1 Time Enable Copy Gard Write *10

* 10. Copy guard code complying to SCMS is recorded. When the tape is played back on a consumer DAT complying to SCMS, it is possible to copy only once.

3. Additional Notes

3-1. If, while ejecting the cassette tape, if the D-20B cannot recognize the reel motor's operation, the display will indicate the error message "En-01" and will stop all operation. To reset the D-20B, turn the power OFF, and then, ON. If, after doing this, the error message does not extinguish, there may be some damage to the recorder. Please contact your nearest Fostex Service Center.

3-2. The D-20B can recognize the ID hole of a cleaning tape cassette. When loading the cleaning tape, the D-20B will not enter the blank search mode. Furthermore, the D-20B cannot be controlled via the 20 pin port (4030) when cleaning the recorder with a standard cleaning tape. If there is no ID hole in the cleaning tape cassette, The D-20B will automatically enter the blank search mode. Please stop the recorder to prevent excessive wear or abuse.

3-3. While recording in the ASSEMBLE mode, when punching out using the PLAY command, the D-20B will use A-time before punching out and entering FREE RUN mode.

When setting the Set Up mode, "E3-02", A-time is the only mode. Setting the T/C REC MONITOR switch to "REPRO" and the TIME CODE INPUT LED will extinguish when this setting is used and the switch has been set thusly. Theremore, the D-20B will output the JAM/SYNC TC from the TC output connector.

3-4. Concerning the Sony BVE-900 etc., when fast searching using the BVE-900 in the 100 times FF or REW mode, time code and data indication of the BVE-900 will occasionally jump. This is not caused by damage to either machine or because of machine trouble. In other words, this is a normal phenomenon. When the BVE-900 controls the D-20B in FF or REW modes, the first few seconds of operation is low speed FF or REW. Afterward, the machines will change to the 100 times speed mode. Please see the following diagram.

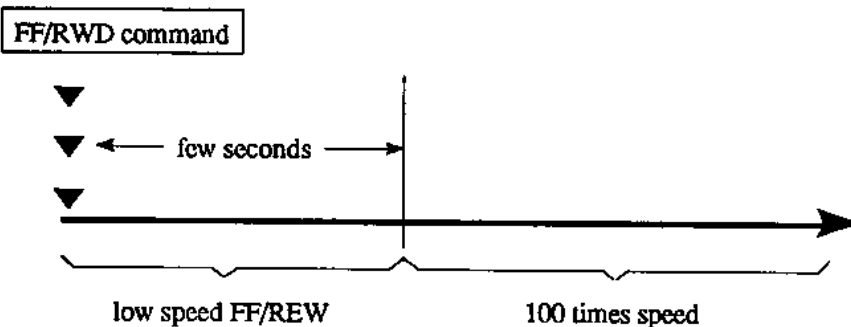

3-5. When in the REHEARSAL mode, INPUT MONITOR canceled mode will be disabled. Only the Fostex 4030 "REC" direct signal and the editor's "EDIT OFF" command can cancel the INPUT MONITOR mode.

Section 8

Application Examples

(Actual examples in using the D-20B are explained here.)

1. Editing System using a VIDEO EDITOR

1-1. D-20B to D-20B Cut Editing (Digital to Digital)

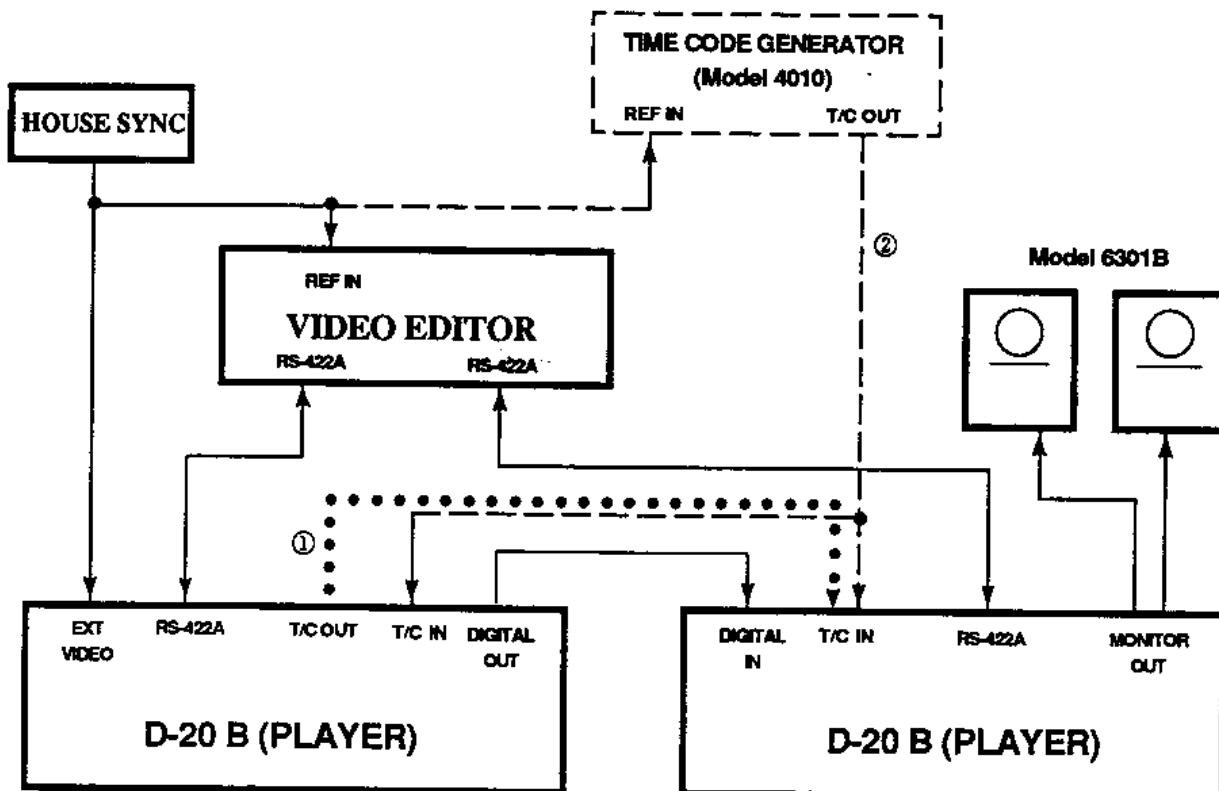

● D-20B (Player) Setup

DIP SW A-1. 2&8	:Set to required frame
DIP SW A-3&4	:OFF,ON(composite)
CLOCK SW	:EXT
EXT REF SW	:VIDEO
REMOTE SW	:REMOTE
E0-**	:Set according to editor type
E1-00	:BVU-800
E3-**	:Required time code format Default is IEC format
E5-00	:Sync play editor only

● D-20B (Recorder) Setup

DIP SW A-1. 2&8	:Set to required frame
CLOCK SW	:INT
REMOTE SW	:REMOTE
INPUT SW	:DIGITAL
EDIT MODE key	:EDIT
JAM key	:ON for assemble editing
E0-**	:Set according to editor type
E1-00	:BVU-800
E2-00 or 02	:For JAM ON
E3-**	:Required time code format E3-00 for JAM ON
E5-00	:Sync play editor only

- To obtain phase modifying accuracy of 1/100 frame, the connections ① and ② in the above schematic input reference time code are recommended. However, it may require a slightly longer lock time than the ① connection. If 1 and 2 are not used as above, accuracy will be about 1/10 of a frame depending on the editor type.

- Any time, minutes and frames may be set for reference time code. However, the phase of SYNC signal must be in sync with the house sync.

1-2. D-20B to D-20B Cut Editing (Analog to Analog)

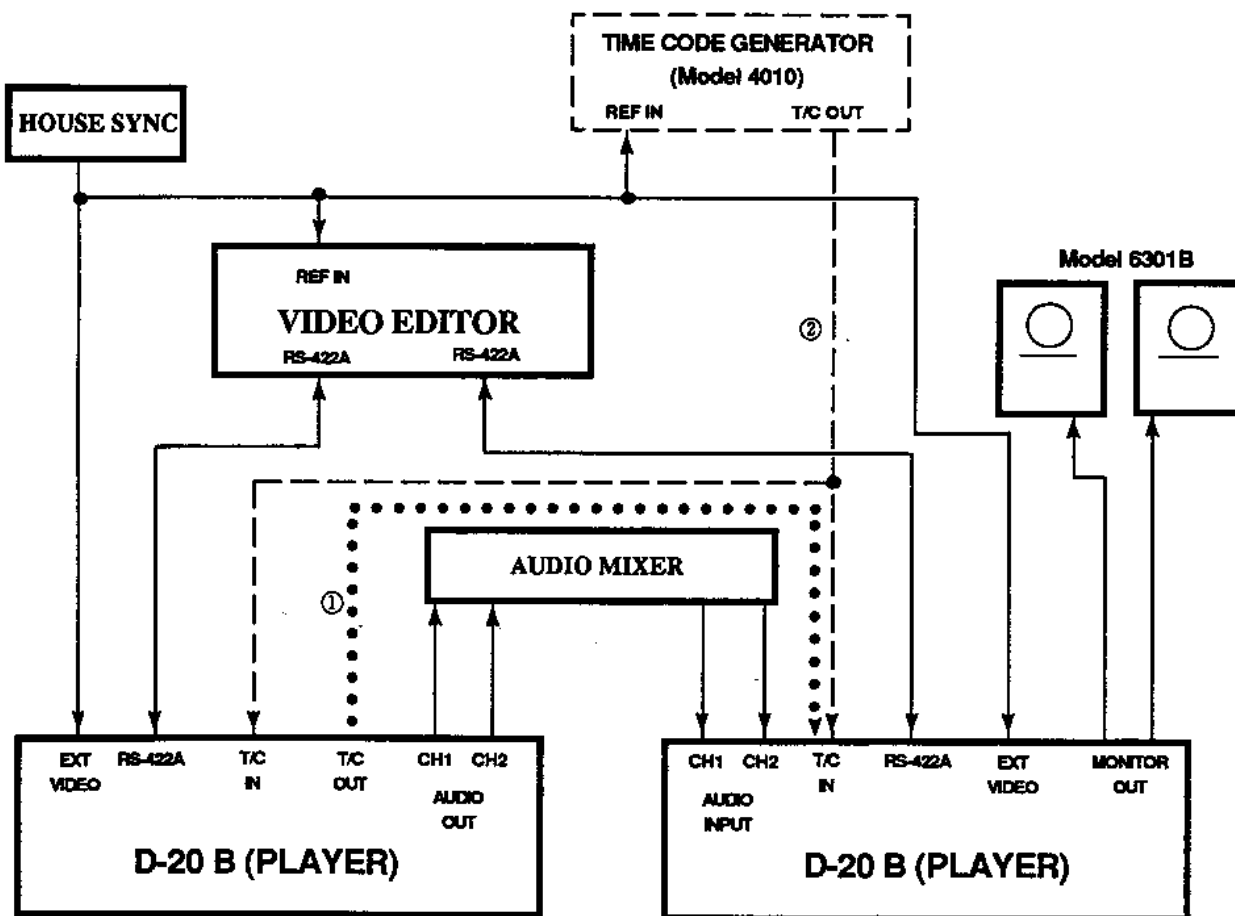

● D-20B (Player) Setup

DIP SW A-1. 2&8	:Set to required frame
DIP SW A-3&4	:OFF, ON (composite)
CLOCK SW	:EXT
EXT REF SW	:VIDEO
REMOTE SW	:REMOTE
E0-**	:Set according to editor type Default is E0-01 CMX-300
E1-00	:BVU-800
E3-**	:Required time code format Default is E3-00 IEC format
E5-00	:Sync play editor only

● D-20B (Recorder) Setup

DIP SW A-1. 2&8	:Set to required frame
DIP SW A-3,4	:OFF, ON(Composite)
CLOCK SW	:EXT
EXT REF SW	:VIDEO
REMOTE SW	:REMOTE
JAM key	:ON for assemble editing
E1-00	:BVU-800
E2-00 or 02	:For JAM ON
E3-**	:Required time code format E3-00 for JAM ON
E5-00	:Sync play editor only

■ To obtain phase modifying accuracy of 1/100 frame, the connections ① and ② in the above schematic input reference time code are recommended. However, it may require a slightly longer lock time than the ① connection. If 1 and 2 are not used as above, accuracy will be about 1/10 of a frame depending on the editor type.

■ Any time, minutes and frames may be set for reference time code. However, the phase of SYNC signal must be in sync with the house sync.

2. Audio Insert from a D-20B to a VTR

2-1. Audio insert from a D-20B to a VTR utilizing the auto edit function of an analog commercial VTR provided with RS-422A.

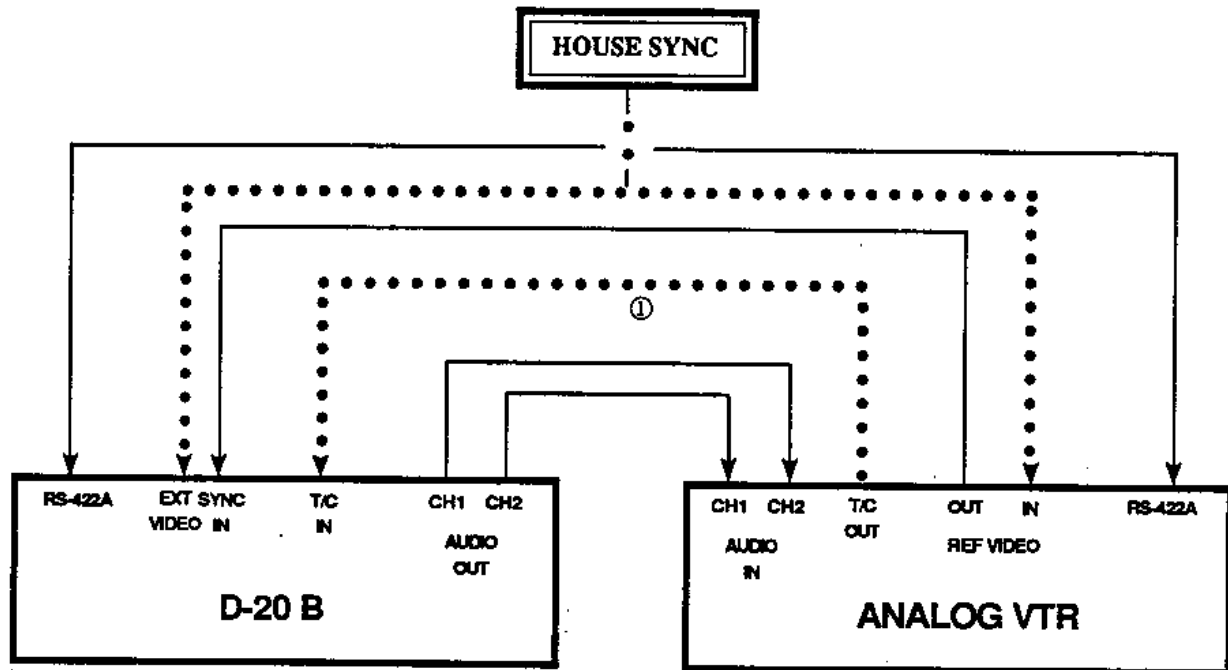

*For details on the AUTO EDIT,
please refer to the operation manual
of the VTR.*

● D-20B Setup

DIP SW A-1, 2&8	:Set to required frame
DIP SW A-3&4	:OFF, ON (composite)
CLOCK SW	:EXT
EXT REF SW	:VIDEO
REMOTE SW	:REMOTE
E0-00	:BVU
E1-00	:BVU-800
E3-**	:Select required time code Default is IEC format
E5-00	:Sync play editor only, or E5-02 all play continue

- To obtain phase modifying accuracy of 1/100 frame, time code input from the VTR ① in the above schematic is recommended. If there is no time code input from ① accuracy will be about 1/10 frame depending on the VTR type.
- If time code recorded in the D-20B and the audio sample clock is not locked at a certain ratio, connect time code ① from the VTR and change setup mode to "E5-02" = All Play Continue.
- Insert to CH3 and CH4 of the Betacam M II is not possible due to its Depth-multiplex recording. Therefore, it is necessary to make the D-20B chase sync with the source side video and simultaneously copy the picture and sound.

2-2. Audio insert from the D-20B to a digital VTR utilizing the auto edit function of the VTR.

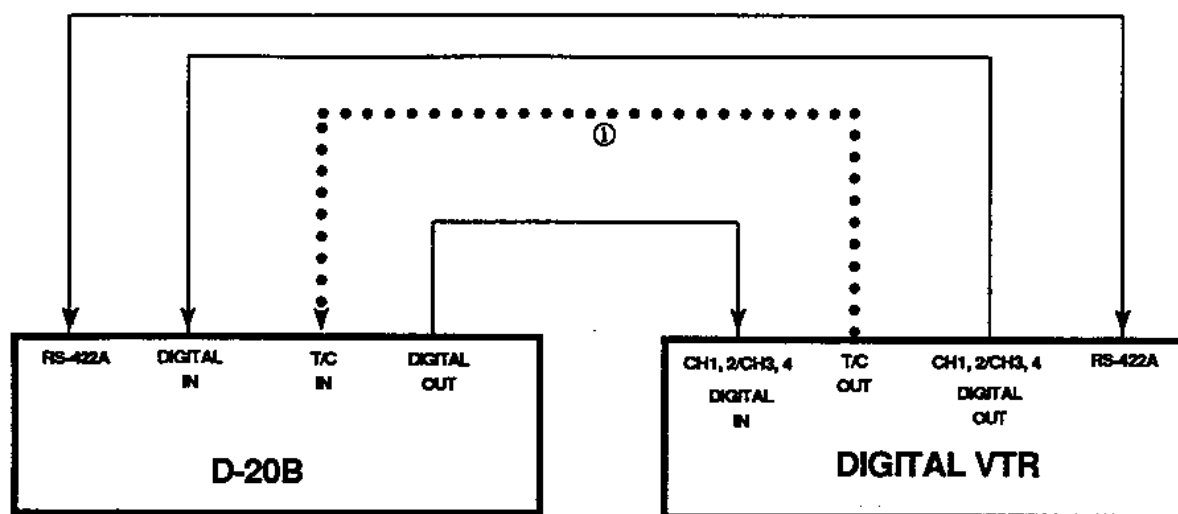

For details on the **AUTO EDIT**, please refer to the operating manual of the VTR.

Insert to Audio **CH1**, **CH2** or **CH3**, **CH4**.

● D-20B Setup

DIP SW A-1, 2&8 :Set to required frame

CLOCK SW :INT

INPUT SW :DIGITAL

REMOTE SW :REMOTE

SAMPLING FREQ :48kHz

SW

E0-00 :DVR, BVU

E1-00 :BVU-800

E3-** :Select required time code
Default is IEC format

E5-00 :Sync play editor only

- To obtain phase modifying accuracy of about 1/100 frame, time code input from the DIGITAL VTR ① in the above schematic is recommended. If there is no time code input from ①, accuracy will be about 1/10 frame depending on the VTR type.
- The digital input of the D-20B is for locking to the DIGITAL VTR WORD CLOCK. In a DIGITAL VTR with WORD CLOCK output, it can also be done by setting the **CLOCK** switch to **EXT** and the **EXT REF** switch to **WORD**.
- A **CRCC ERROR** message will appear in some VTR but this will be no problem if audio can be received.

3. Copying source VTR and D-20B sound to a VTR

In a VTR using Depth-multiplex recording, the last process will be to sync the separate pictures and sound and then dubbing them in the recorder.

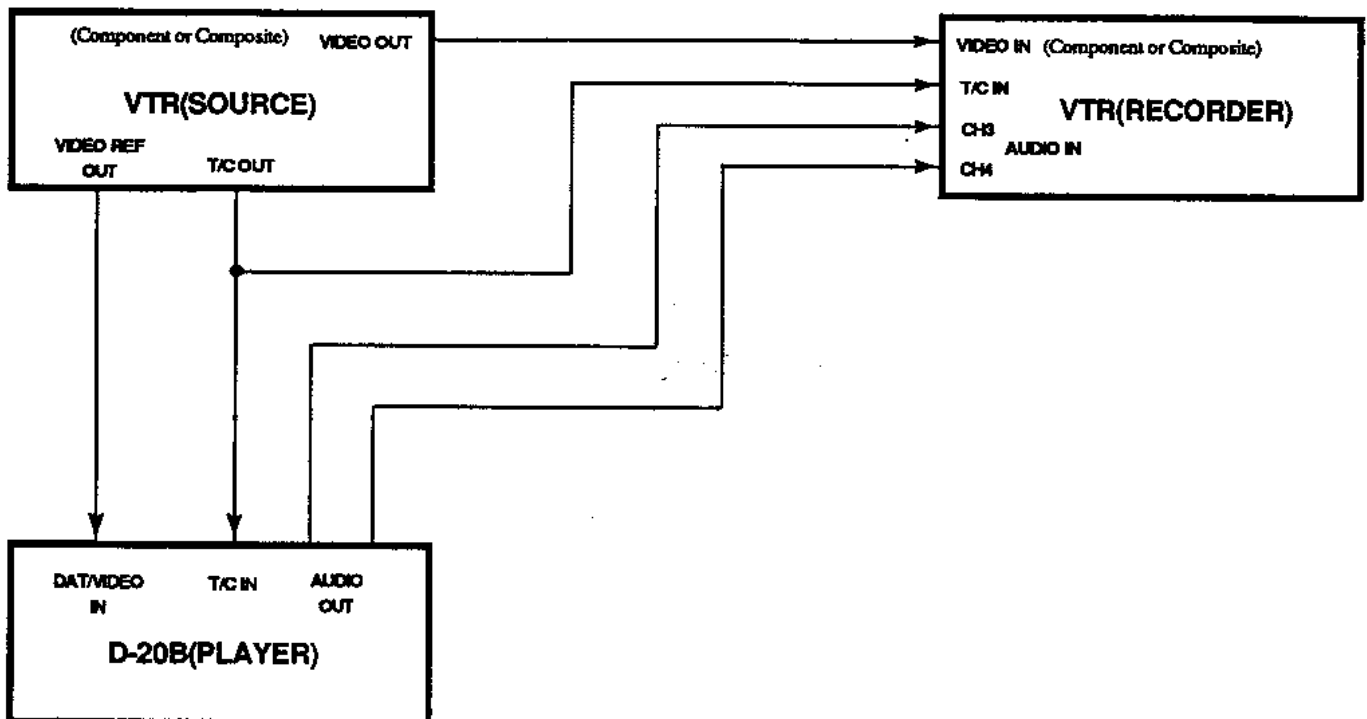

● D-20B Setup

DIP SW A-1, 2&8	:Set to required frame
DIP SW A-3,4	:OFF, ON(Composite)
DIP SW B-3	:ON(Chase mode2)
CLOCK SW	:EXT
EXT REF SW	:VIDEO
E3-**	:Select required time code
E5-02	:Continuously in Sync play
CHASE Key	:ON

- In the above connection example, offset between the source VTR and the D-20B is set to "0". Use a Fostex 8320 controller with the D-20B if offset must be set.
- The D-20B time code reader can read time code only at normal speed in the forward direction. Therefore, either locate the source VTR at its start point or run the source VTR about one second in normal playback and then chase park the D20-B.

4. Chase sync between a VTR and a multiple number of D-20Bs.

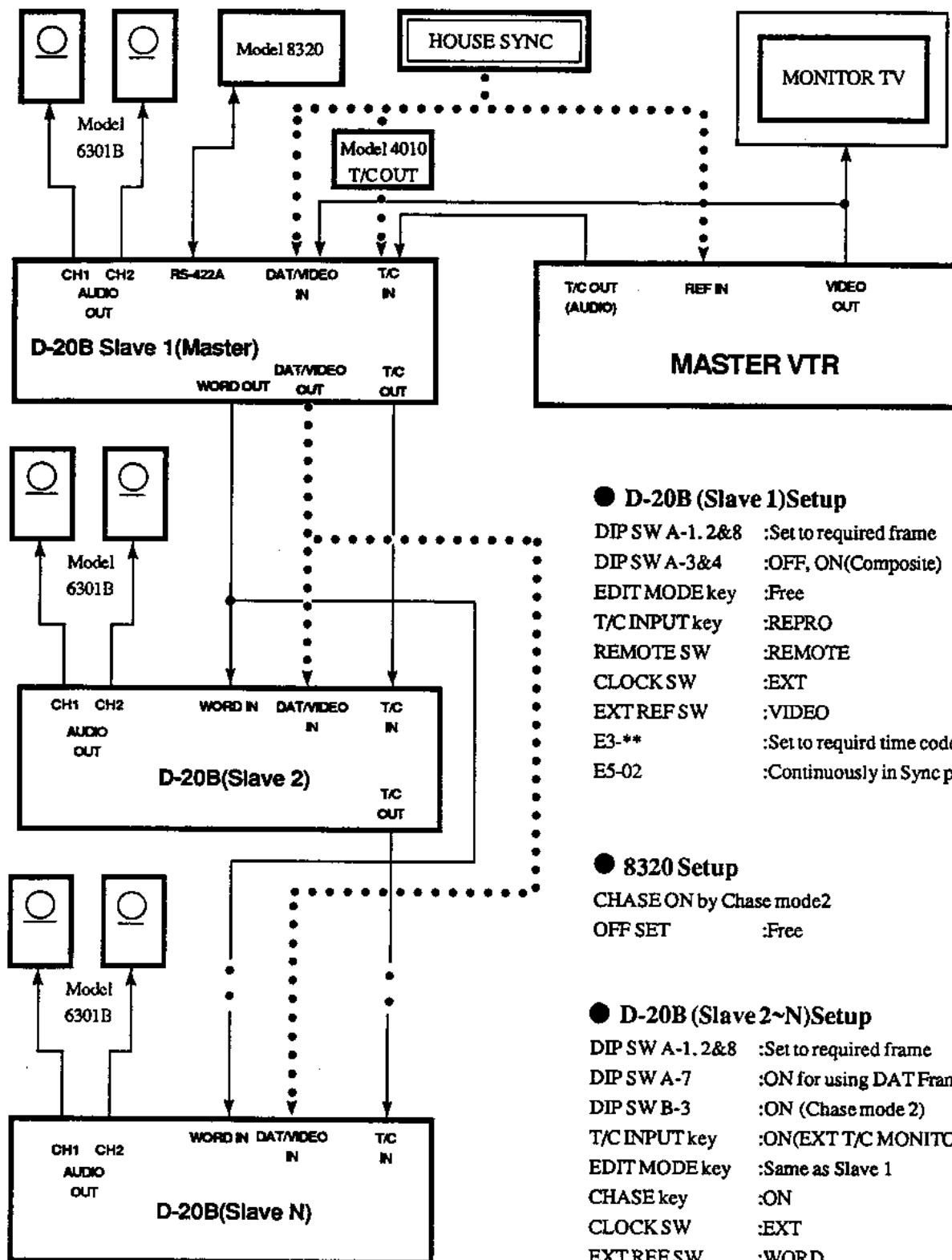

- Offset between the VTR and Slave 1 may be setup with a Fostex 8320. When using the video reference output for input into the D-20B, set to sync play mode E5-02 as the D-20B master clock requires some time to lock.
- Slave 2 through "N" is the mode to lock by setting OFFSET "0" in slave 1. When DAT SYNC is used, it will lock at an accuracy below WORD unit accuracy but a producing SOFT TAPE s in slave 1 through N, it must be done while applying DAT FRAME SYNC lock.

5. VTR and D-20B chase system using a Fostex 4030 for auto control

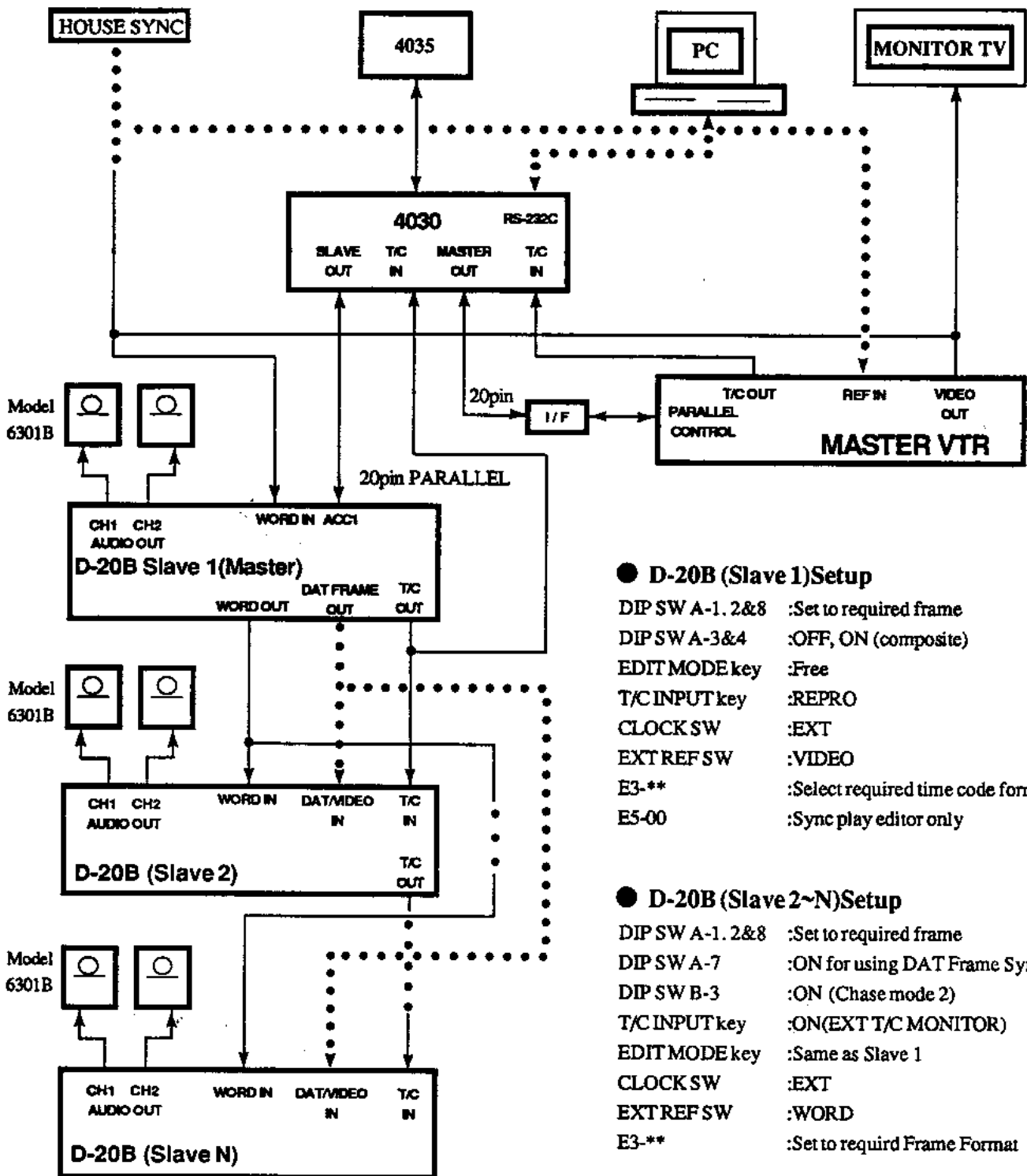

- Control, OFFSET, etc. of the VTR and slave 1 can be done with a Fostex 4030. For details on the 4030, please refer to the Model 4030 section in this manual, as well as, the 4030 operating manual.
- Slave 2 through "N" is the mode to lock by setting OFFSET "0" in Slave 2. It is possible to lock to an accuracy below the WORD unit when DAT FRAME SYNC is used but when producing SOFT TAPES from slave 1 through "N", DAT FRAME SYNC should be applied to record.

6. Producing a soft tape for DAT FRAME SYNC

In order to playback by DAT FRAME SYNC, the multiple number of D20-Bs in DAT FRAME SYNC must simultaneously record the same Time Codes and Audio. The Audio section may be edited after this recording but to assure continuity of the time code, it is recommended that you record a continuous time code up to the end of the tape.

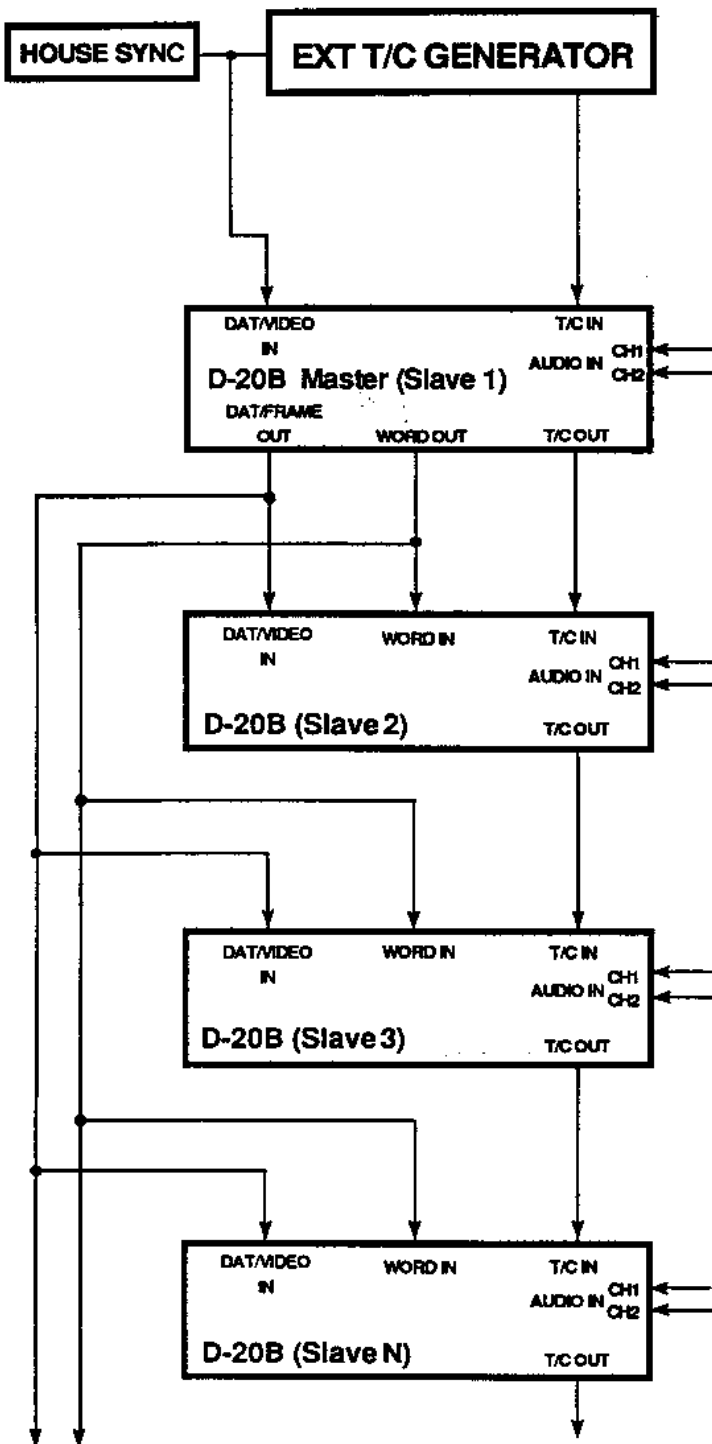

For INTERNAL T/C GENERATOR

● D-20B (Master) Setup

DIP SW A-1, 2&8	:Set to required frame
DIP SW A-3&4	:Set according to requirement
CLOCK SW	: " "
EXT REF SW	: " "
E2-**	:Set to 00 or 02
E3-00	:IEC format
E6-01	:Set to INT. GEN. MONITOR
EDITMODE key	:NORMAL
T/C INPUT key	:ON INPUT MONITOR (GENERATOR OUT)
GEN ON key:	:ON
RECREADY key	:ON

For EXT T/C GENERATOR

● D-20B (Master) Setup

DIP SW A-1, 2&8	:Set to required frame
DIP SW A-3&4	OFF, ON(Composite)
CLOCK SW	:EXT
EXT REF SW	:VIDEO
E2-**	:Required record T/C format
E3-**	: " "
E6-01	:EXT T/C MONITOR
EDITMODE key	:NORMAL
T/C INPUT key	:ON INPUT MONITOR (EXT T/C MONITOR)
GEN ON key	:OFF
RECREADY key	:ON

● D-20B (Slave 2~N) Setup

DIP SW A-1, 2&8	:Set to required frame
DIP SW A-7	:ON for using DAT Frame Sync
CLOCK SW	:EXT
EXT REF SW	:WORD
T/C INPUT key	:ON(INPUT MONITOR)
GEN ON key	:OFF
RECORD READY key	:ON
EDITMODE key	:OFF(Normal)
E2-**	:Same setting as Master
E3-00	:IEC FORMAT
E6-00	:EXT T/C MONITOR

* Simultaneously record by the above connection and setting.

7. Digital connections with other equipments

When making connections with other equipments, the transmitting side normally becomes the master unit. On occasion, however, it may be more convenient if the transmitting side is used as the slave. An example of this is shown below.

7-1. Slave mode by digital audio signal

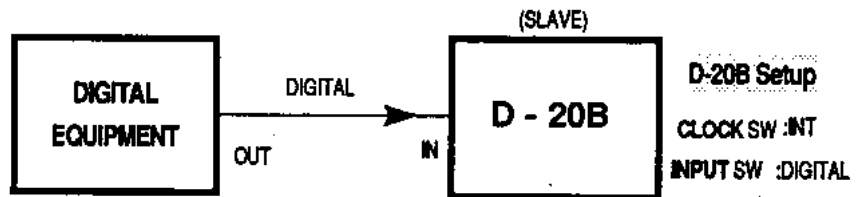

This is an example of normal recording of a digital input. The D-20B synchronizes with the clock in the digital audio signal.

7-2. Slave mode by WORD signal (recording)

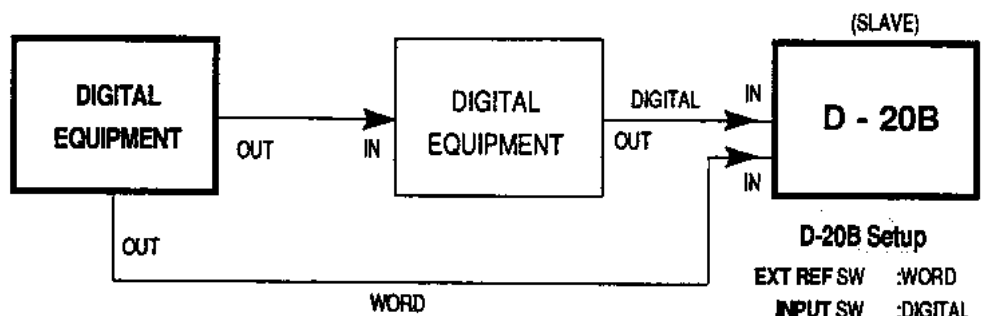

When digital equipment is connected in series, jitter will increase in the clock of the digital audio signal. The connection above shows the mode in which the slave D-20B is synchronized to the clock of the originating digital equipment instead of synchronizing to the clock in the digital audio signal.

7-3. Master mode by digital audio signal

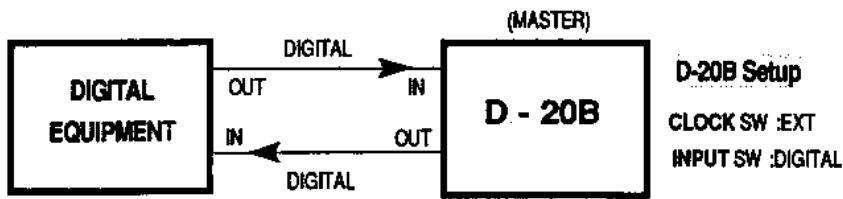

This is the mode for ignoring the digital input clock of the D-20B (master). This is effective when connecting a mixer, D-20B, etc. for the digital equipment. The digital equipment operates by the clock of the master D-20B.

7-4. Master mode by WORD signal

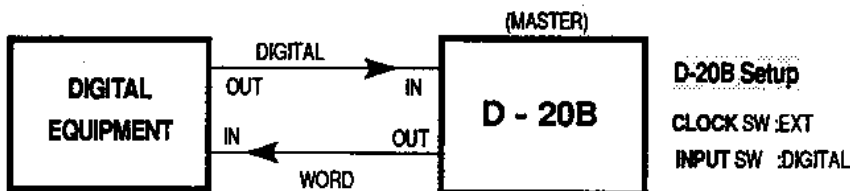

This is the mode for using the D-20B for the master when the digital equipment is a mixer, etc. in which the the clock is not stable.

7-5. Slave mode by WORD signal (playback)

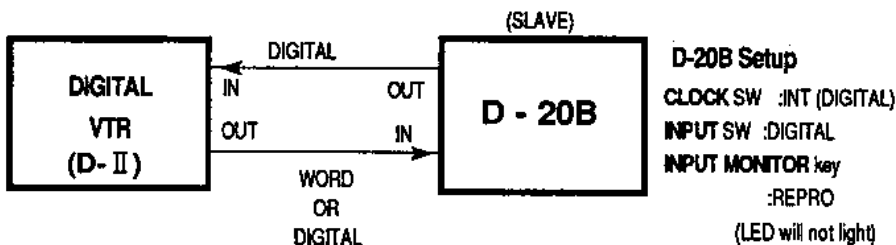

This is the mode to be used for recording the D-20B digital audio signal into a digital VTR, because digital VTR does not have the slave mode controlled by the digital audio signal.

< Note >

Due to the Model D-20B hardware structure, it is not possible to send signals from the SOURCE side to the RECORDER side through the DIGITAL INTERFACE by synchronizing both Model D-20B's to an external VIDEO CLOCK as shown in the schematic below.

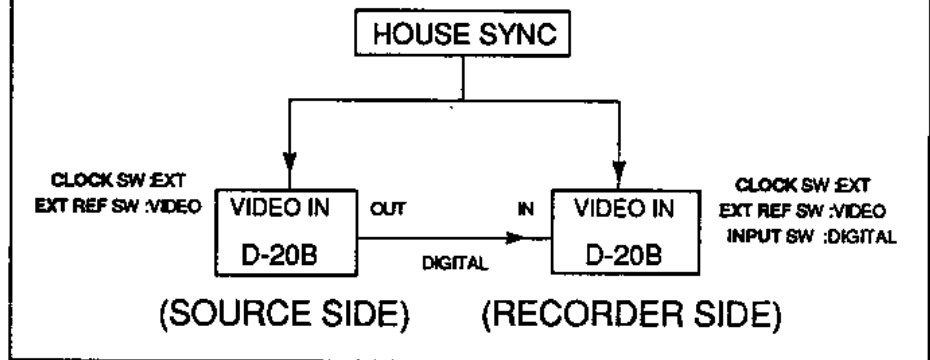

* In regards to application or other information, please contact our business office or service department.

8. Set Up of the 4030 Synchronizer

The 4030 requires Software 3.2 or later to use the D-20B.

Owners of 3.1 or earlier software should contact their authorized Fostex service station. For details on the operation of the 4030, please consult the 4030 owner's manual.

**** After changing the digital switch settings, turn the unit off and then on again.**

- 1 Use a tape on which time codes are recorded.
- 2 Set the 4030 as follows :
 - (1) Use the 4035 and enter "2nd" mode.
 - (2) Press the **TRIM** key to activate the machine mode. Select **MASTER** or **SLAVE** by pressing **READER DISPLAY** key and check the indication shown on the 4035 display. This will be either "Normal", "460", or "D-20" (see below).

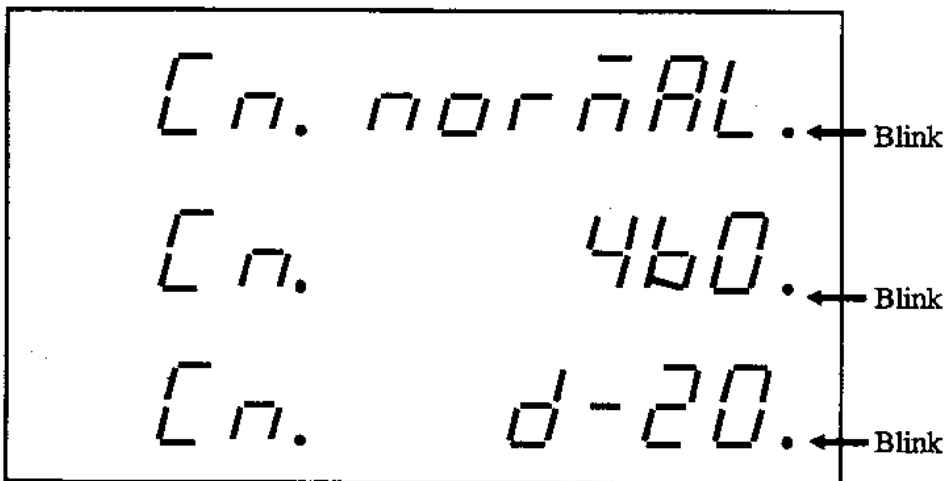

- (3) Use the [+] key to select "D-20".
- (4) Press the [**STO**] key to enter the D-20B mode. The designation on the display (**MASTER** or **SLAVE**) is now set.
- (5) The parameters shown must be set in the 2nd mode. Required settings for other modes may vary depending on how the D-20B is used.

Settings for use as a master recorder

Code only master (2nd, AUTO LOCK).....	1
Code mode (2nd, SYNC LOCK).....	1
Low speed area (2nd, 75).....	1
No tach pulse (2nd, 77).....	1

Settings for use as a slave recorder

Lock damping (2nd, LOCK ENABLE).....	9
Chase window(2nd, 72)	2
Slave code enable (2nd, 76).....	1
Low speed area (2nd, 75).....	1
No tach pulse (2nd, 77).....	1
Slave park point (2nd, CHASE ENABLE).....	Initial setting is 0.*

* Please refer to the 4030 owner's manual.

3. Set the **FREQ - VOLT** switch of the 4030 to **FREQ**.
4. Connect the D-20B to the slave connectors of the 4030 and set the 4035 to 2nd mode and speed display.
5. Set digital switch [8] of the 4030 to **ON** and adjust the servo gain offset for a speed of 1.10 (+10%). After completing the adjustment, set the digital switch to **OFF** again.
6. Set digital switch [7] of the 4030 to **ON** and adjust the servo gain trimmer for a speed of 0.90 (-10%). After completing the adjustment, set the digital switch to **Setup** of the D-20B.

9. Set Up of the D-20B

**** After changing the digital switch settings, turn the unit off and then on again.**

1. Set the mode select digital switches A-1 and A-2 on the rear panel to the position that matches the time code in use.
2. Set the mode select digital switch A-3 and A-4 to the position that matches the input sync signal (frame, field, or composite).
3. Set the mode select digital switch A-6 to ON if there is any possibility that the external or composite sync signal is non-continuous (for example, with laser disc or TV broadcast sources). When a reliable sync signal such as from an in-house generator is available, set this switch to OFF.
4. Set the **CLOCK** switch to **EXT** and **EXT REF** switch to **VIDEO** to enable external or composite synchronization.
5. If synchronization cannot be achieved properly, the **CLOCK LOCK** LED will blink. Check whether all settings are correct and whether the input signal is normal. If the **TIME CODE ERR** LED (red) lights up when time codes are used and the D-20B is set to the **INPUT MONITOR** mode, check all settings from step 1 again.

< Note >

Set the **INPUT** switch of the D-20B to **ANALOG**. If the switch is set to **DIGITAL**, Slave operation is not possible.

Section 9.

RS-422A SERIAL PORT

The RS-422A serial port (D-Sub 9 pin connector) is based on SONY 9 PIN PROTOCOL. Therefore, the new version D-20B may be used with editor or video recorder that uses this protocol.

* It is possible for the digital copy contains all of the data of the original.

1. How to Make Digital Copies**1 - 1. Digital Copy including Sub Code**

(1) Set digital switch C of both Model D-20B as shown below (C1 ~ 4 can be set either way).

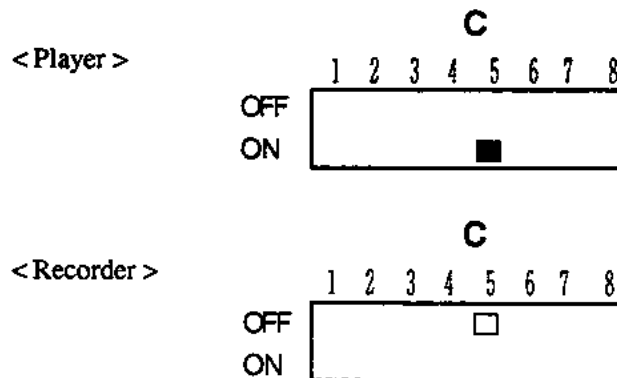
**NOTE 1:**

Be extremely careful not to switch ON the <Recorder> digital switch C-5 as it could cause breakdown of the interface IC.

NOTE 2:

Set 1 ~ 4 of digital switch C, as shown below, on the Model D-20B to which the Model 8320 Remote Control Unit or a SONY 9 PIN PROTOCOL compatible equipment is connected to its DATA COM (D-Sub 9 pin) receptacle.

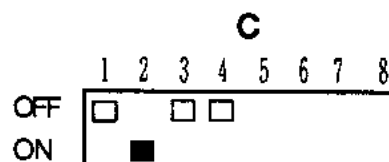

(2) Interconnect the ACCESSORY 2 ports of the <player> and <recorder>, and also between DIGITAL OUT of the <player> and DIGITAL IN of the <recorder> (See drawing below).

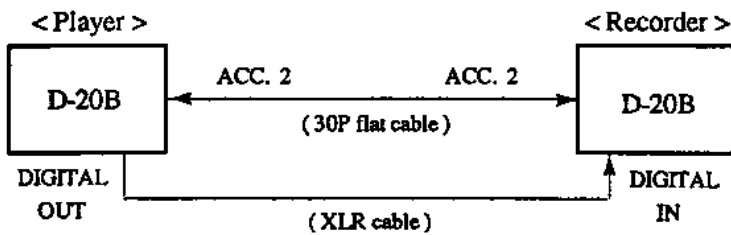

(3) Match the **SAMPLING FREQ** [29] and **EMPHASIS** [26] switches on the <player> and <recorder> with the master tapes configuration.

(4) Set the **AUDIO INPUT** key [18] to OFF(REPRO MONITOR). Be sure to set the **AUDIO READY** key [17] and the **TIME CODE READY** key [20] to OFF.

Next, Set the recorder as follows:

- | | |
|---|---------------|
| <input type="checkbox"/> EDIT MODE key[19] | OFF (LED OFF) |
| <input type="checkbox"/> AUDIO READY key[17] | ON(LED ON) |
| <input type="checkbox"/> TIME CODE READY key[20] | ON(LED ON) |
| <input type="checkbox"/> INPUT switch[31] | DIGITAL |
| <input type="checkbox"/> CLOCK switch[32] | INT |

(5) If a time code different from the master tape is to be recorded, input the time code at the <recorder> TIME CODE INPUT receptacle [43]. A new time code will be recorded on the <recorder> tape (In this process, sub code on the <player> tape will be copied without any change.). In addition, if V-SYNC composite synchronization is to be done, enter the <player> in the external sync mode and apply sync by the same house signal being sent to the time code generator. For the method, please refer to Section 8 "Application Examples" in this manual.

(6) Load master tape on the <player> and a fresh tape on the <recorder>.

(7) Before copying, always check the <recorder> display to see that "DIGITAL INPUT" is lit. (On occasion, it may require some time before DIGITAL INPUT is lit as the vari-pitch mode could be entered temporarily for synchronizing the <player> and <recorder>.)

(8) Start the <player> and <recorder> at the same time. (Simultaneously press the <player> **PLAY** button [5] and <recorder> **REC-PLAY** buttons [3] [5].)

< Note >

- (1) Please note that A-time will not be recorded on the copied tape if no A-time exists on the master tape.
- (2) When the recorder is also operated with GEN ON or JAM SYNC ON, the time code generator will be given priority to write.
*Please refer to related information in Set Up mode E2-**.*

1 - 2. Digital Full Copy Using DAT FRAME SYNC

Accuracy at digital copying can be increased by using the DAT FRAME connector (Refer to "EXT SYNC [47]" in the Controls and Functions section, page 26, for details in regards to the DAT FRAME connector). Next, connect the player DAT FRAME OUT to the recorder DAT/VIDEO IN and be sure to switch on (LED is lit) the player **EDIT MODE** key [19]. In this procedure, offset between the original and the copied tape will be about a constant 5 words and offset between the copies will always be "0" word.

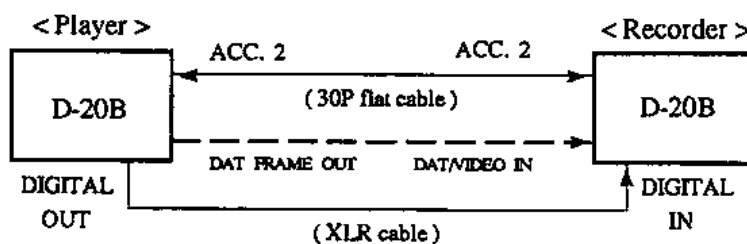

2. 9 pin DATA COM Remote Control

2 - 1. Model 8320

Model D-20B can be remote controlled by connecting the Fostex Remote Control Unit Model 8320. Refer to the Model 8320 Owner's Manual for details.

2 - 2. Editor or commercial use VTR

(SONY 9 PIN PROTOCOL compatible)

As DATA COM connector (D-Sub 9 pin) of Model D-20B employs the SONY 9 PIN PROTOCOL, an editor or commercial use VTR compatible with this protocol, can be used to control the Model D-20B.

2-2-1. Setup for selecting the editor type

Setup the editor type by using the 2nd mode "EO - **". Please refer to "Set Up Menu" for details.

2-2-2. Connection with the editor

The editor is connected to the Model D-20B DATA COM receptacle with the D-SUB 9 pin cable. In LYNX, synchronizing in smaller than frame units will be possible by applying the Model D-20B time code output into the LYNX input.

2-2-3. Increasing synchronizing accuracy by input of the reference time code

Synchronizing accuracy is ± 0.5 frame when Model D-20B is in sync by the composite video signal. If a reference time code (it can be any hour) in sync with the composite video will improve to better than ± 0.03 frame.

2-2-4. Assignment of the editor SAFE/READY

(1) Insert mode

A1 (editor) : CH1, CH2 (D-20B)

A3 (editor) : TIME CODE (D-20B)

Although assignment of the editor are A1:CH1 and A2:CH2, they are controlled by A1 as the recording of CH1 and CH2 cannot be separated in the D-20B. Set the D-20B REC MODE to "EDIT".

(2) Assemble mode

When the editor is entered in the assemble mode, CH1, Ch2 and TIME CODE will change to the "READY" status.

The D-20B REC MODE can be setup using either the "EDIT" or "NORM" mode. However, "Rehearsal" and "Jam Sync" cannot be done in the "NORM" mode.

Summary

The preceding should help you to understand how the controls work on the D-20B. Most of the D-20B recorders sold world-wide are used primarily for production work by professional engineers, although anyone who has operated a basic analog recorder will be happy with how easily it is to convert to digital mastering. If you have any questions or comments, please contact your nearest Fostex Service Center. We will be happy to assist you in any way we can.

Section 10.

SPECIFICATIONS

1. Connector Pin Assignments

Polarity and pin-out assignments for the cannon connectors and the DATA COM connector of the D-20B are shown below.

Cannon Connectors (XLR 3-31, XLR 3-32)

For input and output of analog audio, time code, and the digital signals. Cannon connectors with balanced circuits are used.

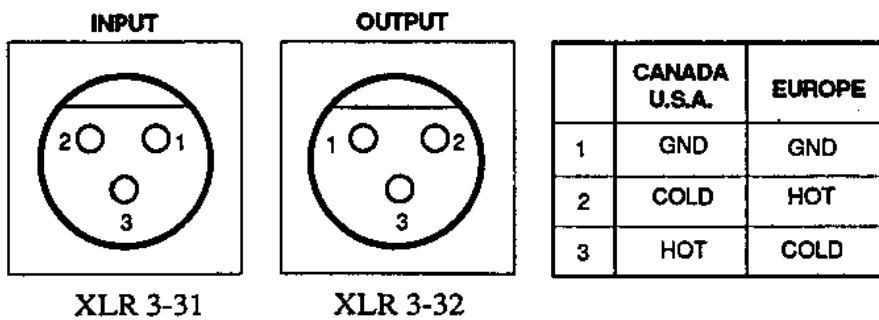

Figure 11
Pin assignments of cannon connectors

* When connecting the output of the D-20B to equipment with unbalanced inputs, use HOT and GND only. Do not connect COLD to GND, as this causes an increase in crosstalk and noise.

* In digital signals, there is no difference between HOT and COLD at the input and output connectors.

DATA COM connector (RS-422A D-SUB 9pin connector)

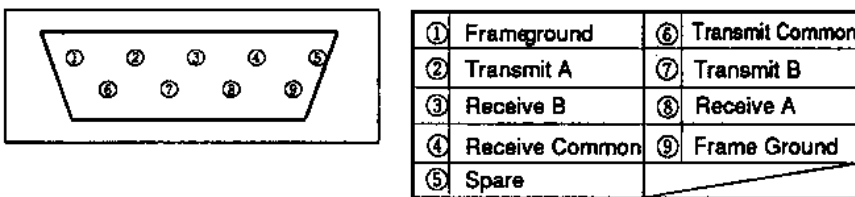
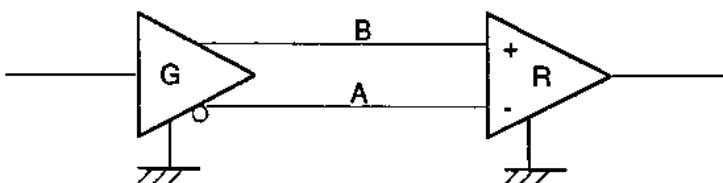

Figure 12
Pin assignments of DAT COM connector

A and B are defined as follows.



A < B - " 1 " (MARK)
A > B - " 0 " (SPACE)

Figure 13
Transmitter and receiver

2. Specifications

Error correction	Double Reed-Solomon code
Tape speed	8.15 mm/sec.
Recording time	Max 120 minutes (with 120 minutes tape)
Fast-forward/rewind time	Approx. 80 seconds (with 120 minute tape)
Cassette tape type	Metal powder DAT cassette
Sampling frequency	48/44.1 kHz (selectable)
Quantization	16 bits linear
Dynamic range	More than 90 dB (1 kHz)
Playback frequency response	20 to 20,000 Hz
T.H.D	Less than 0.05%
Wow-and-flutter	Less than $\pm 0.002\%$ (peak, weighted)
Channel separation	More than 80 dB
Emphasis	Switchable
* Rated Input/Output(Analog)	+4dBu(0dBu=0.775Vrms)
Audio Inputs (CH1, CH2)	
Connector type	XLR 3-31
Rated Input level	+4 dBu (Output is +4 dBu at 18 dB below full scale level)
Input level	+22 dBu
Input Impedance	20 kohms (balanced)
Audio outputs (CH1, CH2)	
Connector type	XLR 3-32
Rated output level	+4 dBu
Suitable load impedance	600 ohms or more (balanced)
Monitor outputs	
Connector type	standard phone jack
Output level	0 dBu
Suitable load impedance	10 kohms or more
Headphone output	
Connector type	standard stereo phone jack
Output level	100 mW (32-ohm load)
Suitable load impedance	8 ohms or more

Digital inputs

Connector type XLR 3-31 (conforming to AES/EBU standard)

Digital outputs

Connector type XLR 3-32 (conforming to AES/EBU standard)

Time code input (SMPTE/EBU)

Connector type XLR 3-31
Rated input level 2 Vp-p (balanced)

Time code output (SMPTE/EBU)

Connector type XLR 3-32
Rated output level 2 Vp-p (balanced)

SYNC Input

Connector type BNC (TTL level)

Accessory 1 connector

Connector type Flat cable 20-pin for parallel interface (model 4030 or similar)

Accessory 2 connector

Connector type Flat cable 30-pin for parallel interface (data I/O)

Data communication connector

Connector type RS-422A (D-SUB 9-pin)

Power requirements

120/220/240VAC, 50/60Hz, 60W

Dimensions

482(W) X 150(H) X 472(D) mm

Weight

Approx. 15 kg (net weight)

Approx. 20 kg (shipping weight)

3. Dimensional Drawings

Figure 14
Dimensional drawing

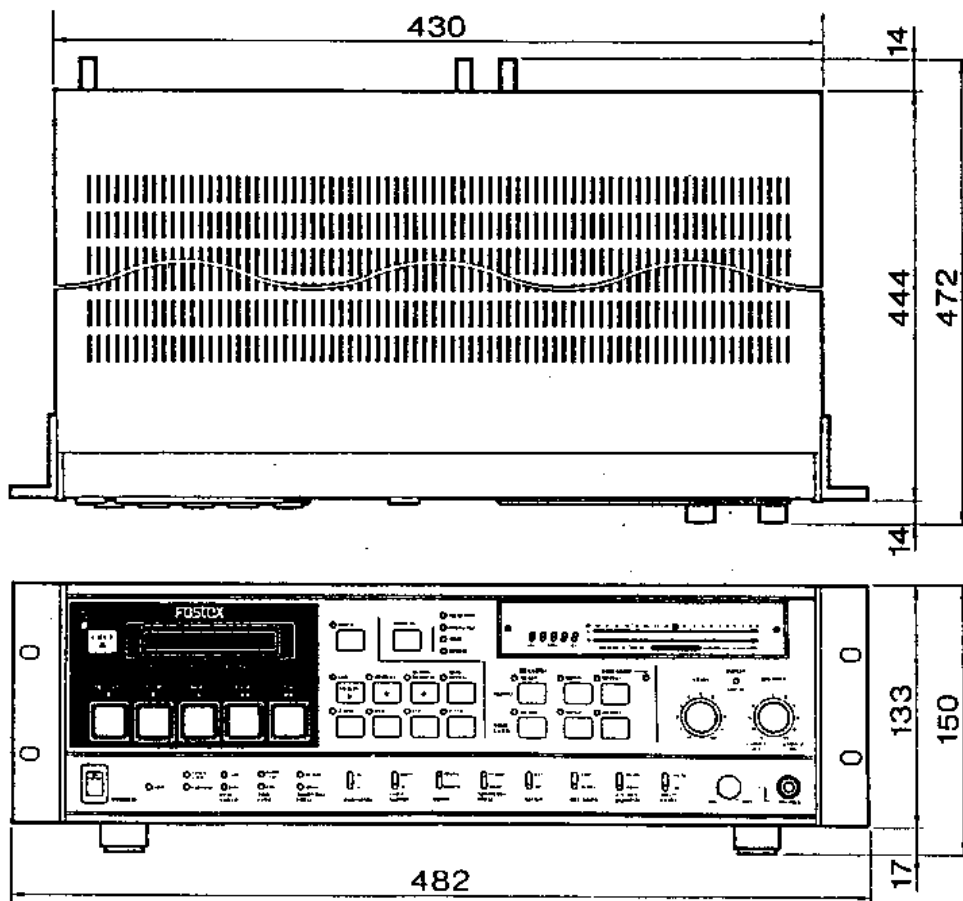

APPENDIX: Signal Format

1. Main ID Format of Audio PCM Signal

Main ID is composed, as shown in Figure 15, of W1 representing the ID and frame address, and W2 representing the block address. Format ID discriminates the recorded signal and "00" is specified for the audio.

Figure 15
Configuration
of main ID

W1 (sub code for main data)								W2 (block address of main data block)								
B7	B6	B5	B4	B3	B2	B1	B0	B7	B6	B5	B4	B3	B2	B1	B0	
Format ID		ID1		Frame address				0	x	x	x	x	0	0	0	
Reserved								0	x	x	x	x	0	0	1	
ID2	ID3		Frame address				0	x	x	x	x	0	1	0		
Reserved								0	x	x	x	x	0	1	1	
ID4	ID5		Frame address				0	x	x	x	x	1	0	0		
Reserved								0	x	x	x	x	1	0	1	
ID6	ID7		Frame address				0	x	x	x	x	1	1	0		
Reserved								0	x	x	x	x	1	1	1	

ID1 through ID7 are ID's for discriminating the audio signal content and is defined as shown in Figure 16. The emphasis characteristic is shown in Figure 17.

Figure 16
Bit assignment
of ID 1 to ID 7

	Usage	Bit assignment
ID1	Emphasis	B5 , B4 0 0: ff 0 1 :50/15 μ sec 1 0 : reserved 1 1 : reserved
ID2	Sampling frequency	B7 , B6 0 0 : 48KHz 0 1 : 44.1KHz 1 0 : 32KHz 1 1 : reserved
ID3	Number of channel	B5 , B4 0 0 :2 channels 0 1 :4 channels 1 0 : reserved 1 1 : reserved
ID4	Quantization	B7 , B6 0 0 : 16 bits uniform 0 1 : 12 bits non-uniform 1 0 : reserved 1 1 : reserved
ID5	Track pitch	B5 , B4 0 0 :normal track mode 0 1 :wide track mode 1 0 : reserved 1 1 : reserved
ID6	Digital copy	B7 , B6 0 0 :permitted 0 1 :reserved 1 0 :prohibited 1 1 :reserved
ID7	Pack	B5 , B4 Pack contents

Figure 17
Emphasis
characteristic

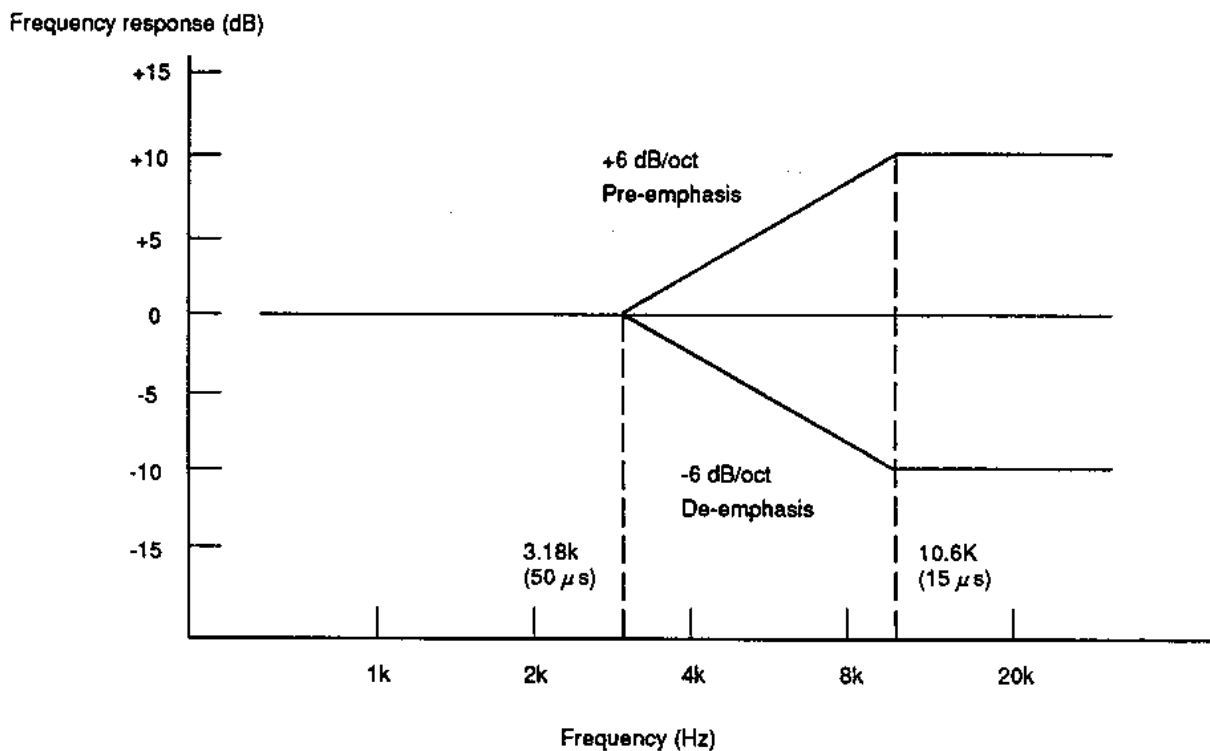

This characteristic is generally employed in digital audio. Track pitch is provided in normal track mode (13.6 μ m) and wide track mode (20.4 μ m). The wide track mode is exclusively for contact printing of music tapes. The D-20B cannot record in this mode but playback is possible. Digital copy prohibiting can be specified. Copy prohibiting can be set by switching the set up Mode to "E8-01". This flag is output only at digital out of the consumer use format.

Although 16 frame addresses are recorded, this is information necessary at data signal processing but are not output externally. The 128 block addresses of W2 indicates the block address in one track. ID of W1 is discriminated by the lower 3 bits.

One word of 16 bits (one audio sample data converted into a specimen and quantized) in the audio PCM signal is split into two parts and processed in 8 bit units. This is called a "symbol". 32 symbols are recorded in one block of the main data.

2. Pack Format of Sub Data

Sub ID in Figure 18 is composed of the control ID, data ID, pack ID and program ID.

Figure 18
Configuration
of sub ID

Sub ID																
SW1								SW2								
Data ID, control ID, pack ID, program number ID (1, 2 and 3)												Address of sub data block				
B7	B6	B5	B4	B3	B2	B1	B0	B7	B6	B5	B4	B3	B2	B1	B0	
Control ID				Data ID 0 0 0 0				1	Pack ID				x	x	x	0
Program number ID2				Program number ID3				1	Program number ID1				x	x	x	1

Control ID, as shown in Figure 19, is defined by the TOC (table of contents) ID, Shortening ID (skipping a section of the program to the next start ID), Start ID (head of program), and Priority ID (program number becomes effective with this flag).

Data ID specifies the content in the sub data area. "0000" indicates that the recorded data are for audio and defines that the later mentioned pack format is employed.

Pack ID indicates the number of packs used.

Program number ID specifies a 3 digit (001-799) program.

Figure 19
Control ID

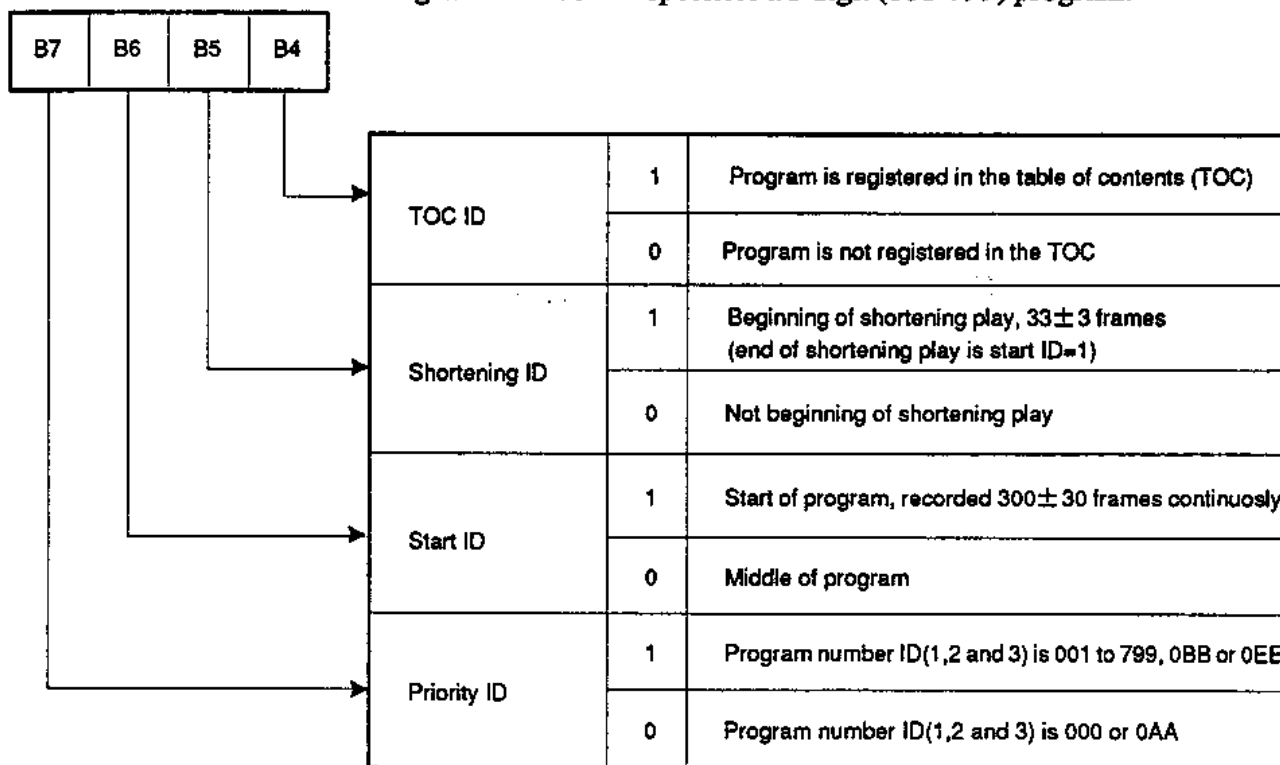

Sub data consists of 32 symbols, as shown in Figure 5 of Section 1, and is divided into four parts of 8 symbols each (64 bits - this is called a pack). The 7 packs data of error correction codes [Reed-Solomon code (32, 28, 5)] contained in two blocks of pack areas 0 through 6 are recorded in pack area 7 (Figure 20). There are 8 sets of this pack group in each track but, as a rule, the same data will be recorded.

Figure 20
Pack location

	SW1		SW2			Sub ID parity	Sub data			
Sync	Control ID	Data ID 0 0 0 0	1	Pack ID	Address x x x 0	Sub ID parity	Pack area 1	Pack area 3	Pack area 5	Pack area 7
Sync	Program number ID2	Program number ID3	1	Program number ID1	Address x x x 1	Sub ID parity	Pack area 2	Pack area 4	Pack area 6	SP parity

Figure 21 shows the pack format. The first 4 bits represent the pack item which discriminates the pack data content; the remaining 52 bits, the pack data and an 8 bit simple parity are located at the end.

Pack item is defined in Figure 22.

	B7	B6	B5	B4	B3	B2	B1	B0	Allocation in sub data
PC1	Pack item								SD i, j
PC2									SD i, j+1
PC3									SD i, j+2
PC4									SD i, j+3
PC5									SD i, j+4
PC6									SD i, j+5
PC7									SD i, j+6
PC8	Pack parity								SD i, j+7

Figure 21
Configuration of pack

$$i=0,2,4,\dots,14 \quad i=1,3,5,\dots,15$$

$$j=0,8,16,24 \quad j=0,8,16$$

Pack parity : $PC8=PC1++PC2++PC3++PC4++PC5++PC6++PC7 \text{ (++: mod2)}$

Pack item	Contents	Remarks
0000	Reserved	
0001	Program time	Program number, index number and continuous time code within a program
0010	Absolute time	Program number, index number and continuous time code on a tape
0011	Running time	PC1,B3=0: specified in this sub-clause for consumer use PC1,B3=1: for professional use
0100	TOC	Table of contents
0101	Data	Year, month, day, the day of the week, hour, minute, second
0110	Catalog number	Catalog number of the cassette
0111	ISRC	The International Standard Recording Code
1000	Pro binary	For professional use
1001	Character	Character information
1010	Reserved	
1011	Reserved	
1100	Reserved	
1101	Reserved	
1110	Reserved	
1111	Reserved	To be defined by pre-recorded tape manufacturers

Figure 22
Assignment of pack item

3. IEC Standard #958 Digital Audio Interface

The digital audio interface is the serial self sync transmission system specifications used at the interconnections between digital audio equipment. This specification is the same as EIAJ standard CP-340, and there is also the broadcasting studio use type (The same as AES/EBU format; this designation will be used throughout this text) and the consumer use type. The channel status format is different between these two types.

This interface, as shown in Figure 23, transmits the 2 channel digital audio data in sync with the sampling frequency.

Figure 23
Frame format

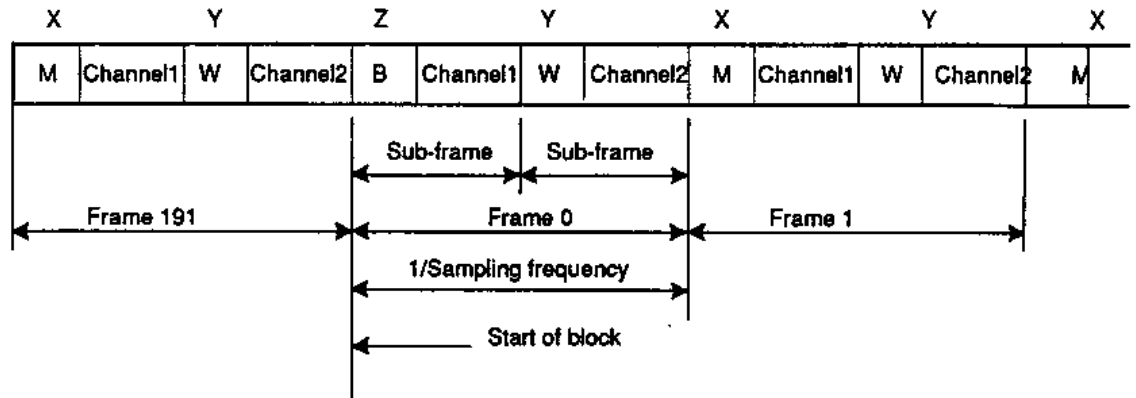

The sub frame is one channel of digital audio data and, as shown in Figure 24, is composed of the sync signal, 24 bit audio data, validity flag, user data, channel status and the parity.

Among these, the channel status bit (one bit) is composed of 192 frames grouped into one status.

Figure 24
Sub frame format

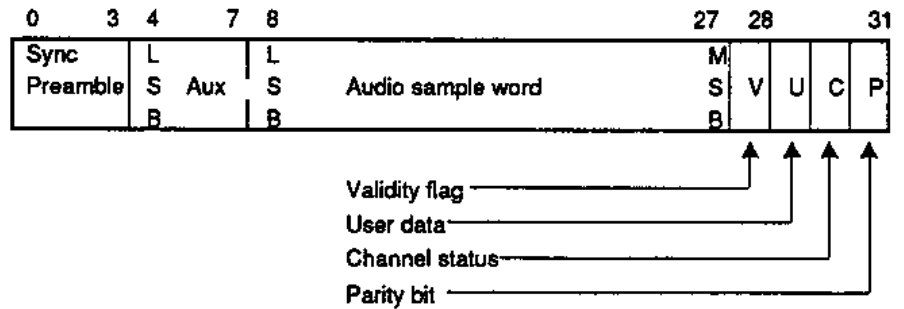

3-1. Channel status of AES/EBU format (Broadcasting studio use)

As shown in Figure 25, this is composed of 192 bits from byte 3 through byte 23. Byte 0 ~ byte 3 is for discriminating audio data, byte 6 ~ byte 13 for alphabet and numerical data, and byte 14-21 for time information. Byte 0 ~ byte 3 are defined as follows:

- a : Difference between AES/EBU format and consumer use - "1"
- b : Audio mode
- c : Emphasis
- d : Lock of source sampling frequency
- e : Specifications of sampling frequency
- f : Number of channels
- g : Management of user bit

- h : Method of using AUX of audio data
- i : Length of source word
- j : For converting to multi channel

In the D-20B, "a" through "f" (bit 3 of byte 0 ... byte 1) are received and sent out.

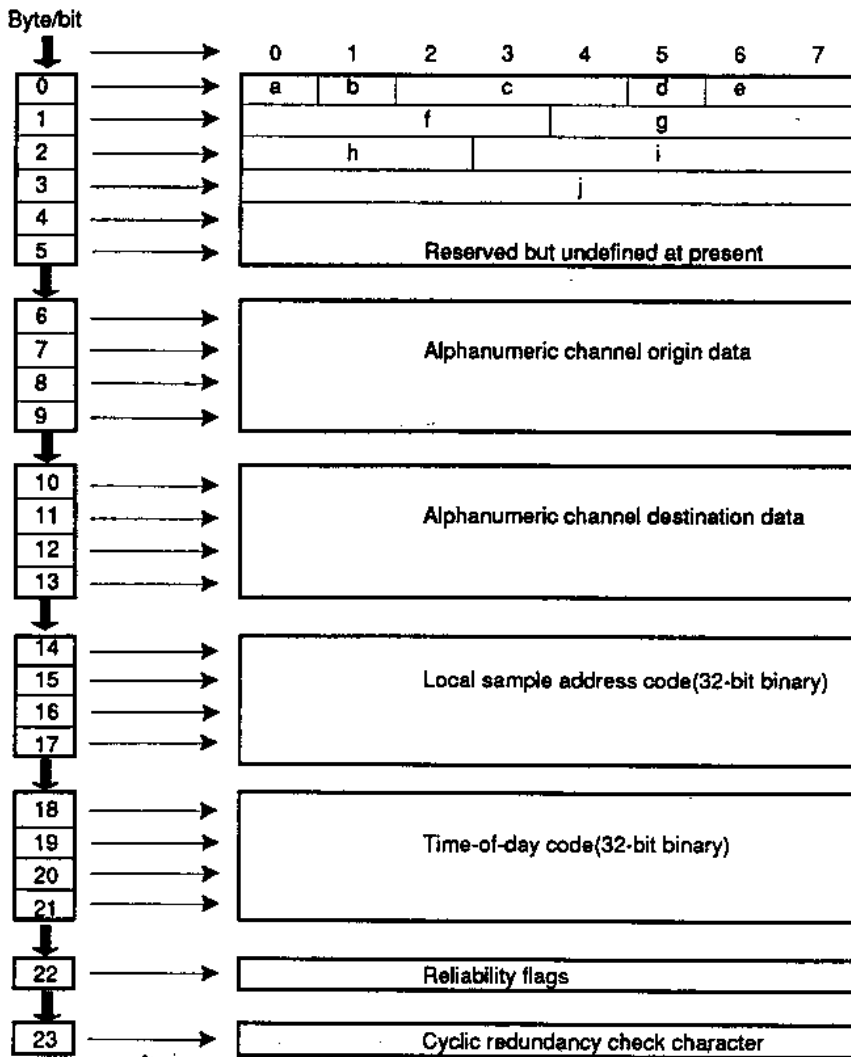

Figure 25
Channel status data format for broadcasting studio use

- a : Use of channel status block "1"
- b : Audio/non-audio mode
- c : Audio signal emphasis
- d : Locking of source sampling frequency
- e : Sampling frequency
- f : Channel mode
- g : User bits management
- h : Use of auxiliary sample bits
- i : Source word length and source encoding history
- j : Future multichannel function description

3-2. Channel status for consumer use

This is composed as shown in Figure 26, and the status up to byte 3 are defined as follows:

Fostex

FOSTEX CORPORATION

3-2-35 Musashino, Akishima-shi, Tokyo, Japan 196

FOSTEX CORPORATION OF AMERICA

15431, Blackburn Ave., Norwalk, CA 90650, U.S.A.

FOSTEX (UK) LTD.

Unit 1 Jackson Way Great Western Industrial Park Southall Middx UB2 4SA U.K.

Free Manuals Download Website

<http://myh66.com>

<http://usermanuals.us>

<http://www.somanuals.com>

<http://www.4manuals.cc>

<http://www.manual-lib.com>

<http://www.404manual.com>

<http://www.luxmanual.com>

<http://aubethermostatmanual.com>

Golf course search by state

<http://golfingnear.com>

Email search by domain

<http://emailbydomain.com>

Auto manuals search

<http://auto.somanuals.com>

TV manuals search

<http://tv.somanuals.com>