

Owner's Manual

Portable Digital Audio Recorder

Model PD-4



Fostex

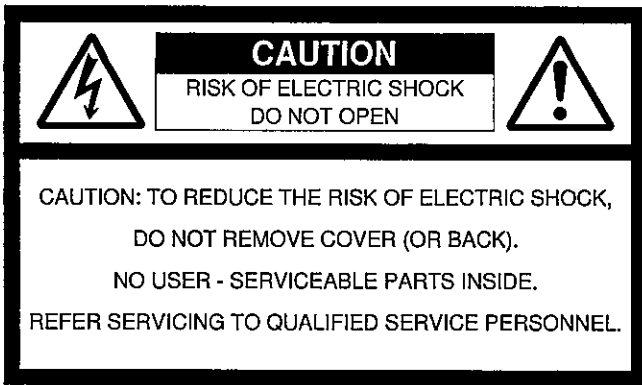

CAUTION:
TO PREVENT ELECTRIC SHOCK, MATCH WIDE BLADE OF PLUG TO WIDE SLOT, FULLY INSERT.

ATTENTION:
POUR ÉVITER LES CHOCS ÉLECTRIQUES, INTRODUIRE LA LAME LA PLUS LARGE DE LA FICHE DANS LA BORNE CORRESPONDANTE DE LA PRISE ET POUSSER JUSQU' AU FOND.



The lightning flash with arrowhead symbol, within an equilateral triangle, is intended to alert the user to the presence of uninsulated "dangerous voltage" within the product's enclosure that may be of sufficient magnitude to constitute a risk of electric shock to persons.



The exclamation point within an equilateral triangle is intended to alert the user to the presence of important operating and maintenance (servicing) instructions in the literature accompanying the appliance.

"WARNING"

"TO REDUCE THE RISK OF FIRE OR ELECTRIC SHOCK, DO NOT EXPOSE THIS APPLIANCE TO RAIN OR MOISTURE."

SAFETY INSTRUCTIONS

1. Read Instructions - All the safety and operating instructions should be read before the appliance is operated.
2. Retain Instructions - The safety and operating instructions should be retained for future reference.
3. Heed Warnings - All warnings on the appliance and in the operating instructions should be adhered to.
4. Follow Instructions - All operating and use instructions should be followed.
5. Water and Moisture - The appliance should not be used near water - for example, near a bathtub, washbowl, kitchen sink, laundry tub, in a wet basement, or near a swimming pool, and the like.
6. Carts and Stands - The appliance should be used only with a cart or stand that is recommended by the manufacturer.



An appliance and cart combination should be moved with care. Quick stops, excessive force, and uneven surfaces may cause the appliance and cart combination to overturn.

7. Wall or Ceiling Mounting - The appliance should be mounted to a wall or ceiling only as recommended by the manufacturer.
8. Ventilation - The appliance should be situated so that its location or position does not interfere with its proper ventilation. For example, the appliance should not be situated on a bed, sofa, rug, or similar surface that may block the ventilation openings; or, placed in a built-in installation, such as a bookcase or cabinet that may impede the flow of air through the ventilation openings.

9. Heat - The appliance should be situated away from heat sources such as radiators, heat registers, stoves, or other appliances (including amplifiers) that produce heat.
10. Power Sources - The appliance should be connected to a power supply only of the type described in the operating instructions or as marked on the appliance.
11. Grounding or Polarization - The precautions that should be taken so that the grounding or polarization means of an appliance is not defeated.
12. Power Cord Protection - Power supply cords should be routed so that they are not likely to be walked on or pinched by items placed upon or against them, paying particular attention to cords at plugs, convenience receptacles, and the point where they exit from the appliance.
13. Cleaning - The appliance should be cleaned only as recommended by the manufacturer.
14. Nonuse Periods - The power cord of the appliance should be unplugged from the outlet when left unused for a long period of time.
15. Object and Liquid Entry - Care should be taken so that objects do not fall and liquids are not spilled into the enclosure through openings.
16. Damage Requiring Service - The appliance should be serviced by qualified service personnel when:
 - A. The power supply cord or the plug has been damaged; or
 - B. Objects have fallen, or liquid has been spilled into the appliance; or
 - C. The appliance has been exposed to rain; or
 - D. The appliance does not appear to operate normally or exhibits a marked change in performance; or
 - E. The appliance has been dropped, or the enclosure damaged.
17. Servicing - The user should not attempt to service the appliance beyond that described in the operating instructions. All other servicing should be referred to qualified service personnel.

1st Edition	MAY 1995	8288 349 000 (for Version 1.00)
2nd Edition	JULY 1995	8288 349 100 (for Version 1.01)
3rd Edition	OCT. 1995	8288 349 200 (for Version 1.03)
4th Edition	DEC. 1995	8288 349 300 (for Version 1.04)
5th Edition	JULY 1996	8288 349 400 (for Version 2.00)
6th Edition	JAN. 1997	8288 349 500 (for Version 2.10)
7th Edition	OCT. 1997	8288 349 600 (for Version 2.20)
8th Edition	SEP. 1998	8288 349 700 (for Version 2.30)
9th Edition	DEC. 1998	8288 349 800 (for Version 2.40)
10th Edition	APR. 2001	8288 349 900 (Headphone Matrix Function)

PD-4 Owner's Manual Supplement
<Headphone Matrix Function>

Function Extending

In this product, "headphone matrix function" is added to its original functions and as shown in schematic below, a headphone output selector switch is provided at right side of PD-4.

Using this switch, headphone outputs complying to the purpose can be obtained. Please refer to "Details on the output signals" below.

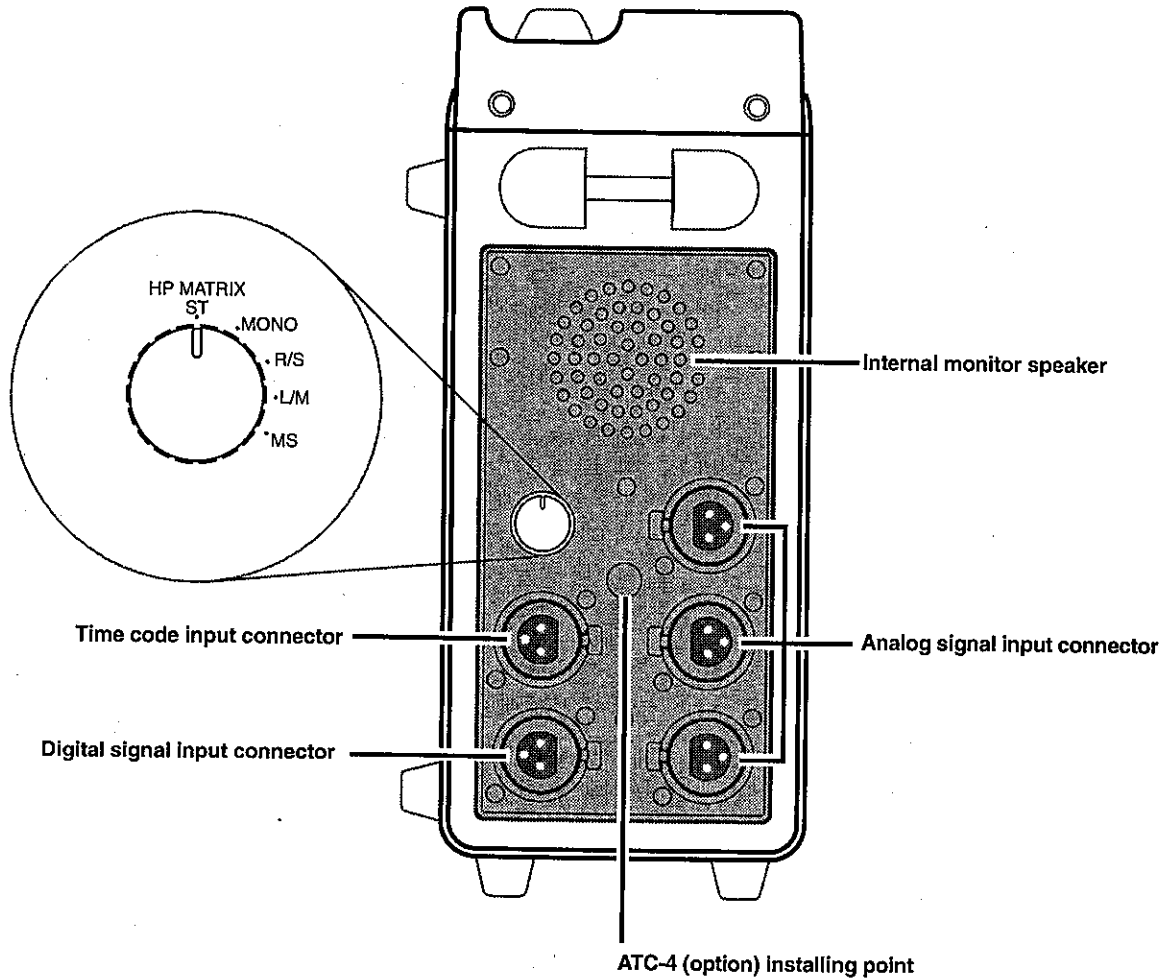

SW position	Output Signals
ST (Stereo)	Stereo signal (L/R) will be output.
MONO	L+R (monaural) signal will be output to both channels.
R/S (Right/Side)	The "Right/Side" signal will be output to both channels.
L/M (Left/Mid)	The "Left/Mid" signal will be output to both channels.
MS (Mid/Side)	Using decode for MS mic, the "M+S" signal is output to the L channel, and the "M-S" signal to the R channel.

PD-4 Owner's manual
<V2.40 Supplement>

FUNCTIONAL EXTENSION AFTER VERSION UPGRADE

The software for the Fostex Model PD-4 has been upgraded to Version 2.40. The warning function, which indicates consumption of the internal battery has been extended, and a menu to set this warning [SU 119] (Setup of the voltage warning) added.

Because this voltage warning can be preset, the PD-4 can operate most efficiently with the battery of your choice, and be used at maximum performance.

In the default setting, the warning voltage is set at 10.5V (average figure) assuming that a NiCad type battery will be used. This warning can be adjusted in 0.5V increments between a range of 10.0V ~ 13.0V.

If battery voltage drops below the setup warning figure, an alarm (beep-beep) will be heard from the internal speaker, and [BATTERY] in the display will blink.

To replace the internal battery, refer to page 23 of the manual.

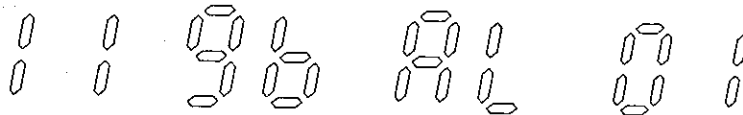

SU 119 setting	Setup Contents
119 b AL-00	Warning voltage: 10.0 V
119 b AL-01 (*)	Warning voltage: 10.5V (Default setting: This is the recommended voltage for a NiCad battery.)
119 b AL-02	Warning voltage: 11.0V
119 b AL-03	Warning voltage: 11.5 V
119 b AL-04	Warning voltage: 12.0 V
119 b AL-05	Warning voltage: 12.5V (This is the recommended voltage for a lithium ion battery.)
119 b AL-06	Warning voltage: 13.0 V

<Note>

Please remember that these are average figures when referring to the above recommended voltages for nickel cadmium and lithium ion batteries.

PD-4 Owner's manual
<V2.30 Supplement>

Changes in Function Relative to Version Up of PD-4 (V2.30)

The PD-4 software has been changed from V2.20 to V2.30 and as a result, the following functions have been extended or added. Because the new functions are only explained in this modified edition issued prior to this V2.30.

1. "Setup of the monitor signal output from the XLR connector at recording" has been added to the SETUP mode.
2. "Setup of the JAM key function" has been added to the SETUP mode.
3. The SETUP mode [SU 411] function has been extended for setup of the record/order in display of the user bit.

New Function - 1 (SETUP mode [SU 118])

A new item [SU 118] which functions to setup the monitor signal output of the PD-4 XLR connector at recording has been added. By switching ON this function, it is possible to confidence monitor of the output signal from the XLR connector.

Setup items by [SU 118] can be selected to either [ON] (effective) or [OFF] (ineffective) as listed below. It is [OFF] (ineffective) in the initial state.

11 8L 75 00

Setting of SU 118	Function
118LMS-00 (*)	OFF (ineffective)
118LMS-01	ON (effective)

Depending on the [SU 118] setup and the confidence switch setting, the recording monitor signal output from the XLR connector, PHONES jack and internal monitor speaker will be as follows.

Setting of [SU 118]	118LMS-01 (ON)				118LMS-00 (OFF)			
	ON		OFF		ON		OFF	
Setting of the confidence monitor switch								
Recording mode	ON	OFF	ON	OFF	ON	OFF	ON	OFF
XLR connector output signal	Confidence monitor	Analog monitor						
Output signals from PHONES jack and internal monitor speaker	Confidence monitor	EE monitor			Confidence monitor	EE monitor		

New Function - 2 (SETUP mode [SU 412])

The PD-4 contains a JAM function for successively free running the time data/timing of the time code by the PD-4 internal time code generator (INT GEN) when external time code is input.

In the additional SETUP mode of [SU 412], when this JAM function is to be executed, the content of the time code data for executing JAM can be selected from the three items below.

41 2J Añ 00

Setting of SU 412	Function
412JAM-00 (*)	JAM is possible for both TC and UBIT.
412JAM-01	JAM is possible only for TC, for UBIT, the PD-4 data is given priority.
412JAM-02	JAM is possible only for UBIT, for TC, the PD-4 data is given priority.

The Extended Function (SETUP mode [SU 411])

The setup function [SU 411] of "user bit record/order of display" in the SETUP mode has been extended again and the following has been added.

Before version up

Setting of SU 411	Record/Order of display
411ubd-00 (*)	Reel No./YY/MM/DD
411ubd-01	DD/MM/YY/Reel No.
411ubd-02	MM/DD/YY/Reel No.
411ubd-03	Event No./Reel No.
411ubd-04	User Definable

After version up

Setting of SU 411	Record/Order of display
411ubd-00 (*)	Reel No./YY/MM/DD
411ubd-01	DD/MM/YY/Reel No.
411ubd-02	MM/DD/YY/Reel No.
411ubd-03	Event No./Reel No.
411ubd-04	User Definable
411ubd-05	YY/MM/DD/Reel No.

← New addition

For 411ubd-00, 01, 02 and 05, by setting each in their respective modes, the content to be recorded in each binary group and their order of display will be interchanged and when power to PD-4 is switched ON, the year, month and day information will be obtained from the real time clock. Each digit of the year, month, day and reel number can be edited within the range of 0 ~ 9 and A ~ F while in the user bit editing function (For explanation on user bit editing, refer to "Additional Edition to V2.10" inserted in later pages. The complementary items in the binary group (BG) of the new addition 411ubd-05 and the record/order of display content, will be as follows.

Setting \ BG	7 6		5 4		3 2		1 0	
	411ubd-00 (*)	Reel No.		YY (year)		MM (month)		DD (day)
411ubd-01	DD (day)		MM (month)		YY (year)		Reel No.	
411ubd-02	MM (month)		DD (day)		YY (year)		Reel No.	
411ubd-03	Event No.					Reel No.		
411ubd-04	User Definable							
411ubd-05	YY (year)		MM (month)		DD (day)		Reel No.	

PD-4 Owner's Manual <V2.20 Supplement>

Changes in Function with Version Up (V2.20) of the PD-4

The PD-4 software has been version upped from V2.10 to V2.20 and the following functions have been added. In this supplement, only the new functions are explained. For basic operation of the PD-4, please refer to the Owner's Manual and Additional Edition issued prior to this V2.20.

1. The TIME display prior to switching off the power will be backed up.
2. The function (SETUP mode) of the user bit display order has been expanded.

Expanded function-1

The TIME display prior to switching off the power will be backed up.

Prior to V2.20, A-TIME was always displayed when power was switched OFF or ON.

In V2.20, the display will be backed up before power is switched OFF. When power is switched ON again, the display prior to switching OFF will be shown.

Expanded function-2

The setup function of the user bit display order has been expanded.

The user bit binary group and the setup function (SU 411) to set up the order displayed of the corresponding record and display content added to the V2.10 SETUP mode, have been expanded and the following two items added to the original items.

Setup Items already added to V2.10

411ubd-00 (*)	Order of display: Reel No./YY/MM/DD
411ubd-01	Order of display: DD/MM/YY/Reel No.
411ubd-02	Order of display: MM/DD/YY/Reel No.

(*): Default Setting

By setting the above three items in their respective modes, contents recorded in each binary group and their displayed order can be interchanged (Refer to the chart below). Year, month and day information will be read-in from the real time clock at switch on of power to the PD-4. Also, each digit of the date and reel number can be edited within the range of 0 ~ 9 and A ~ F (For user bit editing, refer to the V2.10 edition included in later pages.).

Each binary group (BG) and recorded content are as follows:

Setting \ BG	7	6	5	4	3	2	1	0
411ubd-00	Reel Number		YY (Year)		MM (Month)		DD (Day)	
411ubd-01	DD (Day)		MM (Month)		YY (Year)		Reel Number	
411ubd-02	MM (Month)		DD (Day)		YY (Year)		Reel Number	
411ubd-03	Event Number				Reel Number			
411ubd-04	User Definable							

Items added in V2.20

411ubd-03	Order of display: Event No./Reel No.
411ubd-04	Order of display: User Definable

Display order of each binary group is fixed.

Also, in the new "411ubd-03" mode only, the Reel Number will be effective up to three digits.

However, the lower two digits only will be effective in the "411ubd-00," "411ubd-01," and "411ubd-02" modes (Also when using the optional Model ATC-4 AATON, the lower 2 digits only will be transmitted to AATON.).

<The Event Number>

The Event Number will increase automatically when a Start ID (P NO) is recorded at the start of the recording and recorded in the User Bit. Numbers which can be set are in the "0 ~ 99999" range.

After setting the User Bit in the "411ubd-03" mode, it can be edited using the User Bit editing mode or renewed when JAM is executed in external time code. If the Event Number is to be reset (00000), select the Event Number display of the editing mode and input "00000." In the EXT RUN mode, the EXT TC User Bit will be given priority.

<User Definable>

User definition can be input at will. A maximum of 8 letters can be input within a range of 0 ~ 9 and A ~ F. After setting the User Bit in the "411ubd-04" mode, it can be edited using the User Bit editing mode or renewed when JAM is executed in EXT TC. In the EXT RUN mode, the EXT TC User Bit will be given priority.

For details on each binary group (BG) and recording content, refer to the chart on the following page. The condensed chart below presents the display order of the user bit shown as the SETUP mode "SU 411" setup content, and the edit point moving/numbers which can be input in the user bit editing mode.

SU 411 setting	Order of user bit display By changing the SU 411 setting to "00," "01" or "02," display order of the binary group can be changed. "03" and "04" are fixed.	When in the user bit editing mode The edit point shifts in the direction of the arrow when the EDIT/> button is pressed while in the edit mode.	Numbers which can be input
411ubd-00	<p>Reel No. YY (Year) MM (Month) DD (Day)</p> <p>18 97 10 01</p>		<p>[0 ~ 9 and A ~ F] One digit can be input at the blinking edit point (It automatically shifts to the next upper digit).</p>
411ubd-01	<p>DD (Day) MM (Month) YY (Year) Reel No.</p> <p>01 10 97 18</p>		<p>Same as above.</p>
411ubd-02	<p>MM (Month) DD (Day) YY (Year) Reel No.</p> <p>10 01 97 18</p>		<p>Same as above.</p>
411ubd-03	<p>Event Number Reel Number</p> <p>00 00 00 00</p>		<p>[0 ~ 9] Input is possible at the blinking edit point.</p>
411ubd-04	<p>User Definable</p> <p>00 00 00 00</p>		<p>[0 ~ 9 and A ~ F] Input is possible at the blinking edit point.</p>

PD-4 Owner's Manual <v2.10 Supplement>

Change In Function Associated With Version Up Of PD-4

The software has been version upped to V2.10 and consequently, the following functions have been added.

1. Editing function of TC user bit in the 24H RUN mode.
2. Time code edit function in the REC RUN mode.
3. Setting up the user bit display order in the SETUP mode.
4. Extension of display switching function.
5. Establishing the PCM ERROR indicator lighting level in the SETUP mode.
6. Extension of error tone function.
7. Functional extension in lighting time of the display back light.
8. Functional extension in setting the pause mode release time.
9. Muting the internal speaker output in the SETUP mode.

Additional Function

1. Editing Function of TC User Bit in the 24H RUN Mode.

It is now possible to edit the time code user bit in the 24H RUN mode.

<Operating Example>

1. Using the ▲ / ▼ key of the DISP QUIT key, the display is changed to show [GEN UB].
2. Next, when the EDIT/> key is pressed once, the PD-4 will enter the user bit edit mode and the left end number of the display will blink.
*If the "User bit display order" setting explained later, is "411-000" (Initial setting), the blinking digit indicates the Reel No.
If this setting is "411-001," then "DD (day)," and if "411-002," then "MM (month)" will, respectively, blink (Refer to page 3 for details on "User bit display order.").*
3. Press the EDIT/> key to move to the point for editing.
4. Press the ▲ / ▼ key to edit the number.
5. After editing, press the MARK/SET key to set the new number.

Extended Function

2. Time Code Edit Function in the REC RUN Mode.

In recording time code during the REC RUN mode, previously, it was possible to edit TC figure of the INT TC generator only in the REC mode but after this version up, it is now possible to also edit the TC figure in modes other than the REC mode. Consequently, if recording is started after editing the TC figure while in STOP or PAUSE, time code will be recorded from this newly edited TC figure.

<NOTE>

*After editing, if TC on the tape is read by PLAY, FF or REWIND, the edited TC figure will be replaced by the TC figure on the tape.
If recording is started from the START or PAUSE mode, it will start recording from the TC figure of the edited TC generator even though TC is recorded on the tape.*

Additional Function

3. Setting Up the User Bit Display Order in the SETUP Mode.

The function of establishing the user bit binary group and the order in display of the corresponding display content is newly added in the SETUP mode as number "SU 411."

<NOTE>

Each binary group and corresponding recorded content are fixed and the change is only in the order of displaying the content.

The ▲ and ▼ keys are simultaneously pressed to enter the SETUP mode. After displaying the SETUP mode initial display, the ▲ / ▼ keys are pressed again to select the desired mode number (Here, select number "411 ubd 00").

After this, by pressing the MARK/SET key, it is possible to set the selected SETUP mode. As the initial setting is "000" (Refer to following), change to the desired number with the ▲ / ▼ key, then set with the MARK/SET key (* is the initial setup figure).

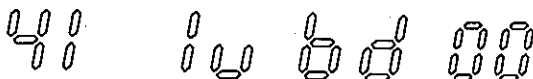

411ubd:00 (*)	Order of display :Reel No./YY/MM/DD
411ubd:01	Order of display :DD/MM/YY/Reel No.
411ubd:02	Order of display :MM/DD/YY/Reel No.

Each binary group (BG) and recorded content are as follows:

BG01: DD (day) BG23: MM (month)
 BG45: YY (year) BG67: Reel number

Extended Function

4. Extension of Display Switching Function.

By extending the display switching function of the EXT RUN and FREE RUN/REC RUN/24H RUN modes, quick switching is now possible by pressing the DISP QUIT and ▲ / ▼ keys. The recorder will be switched in the active modes as follows.

<In the EXT RUN mode>

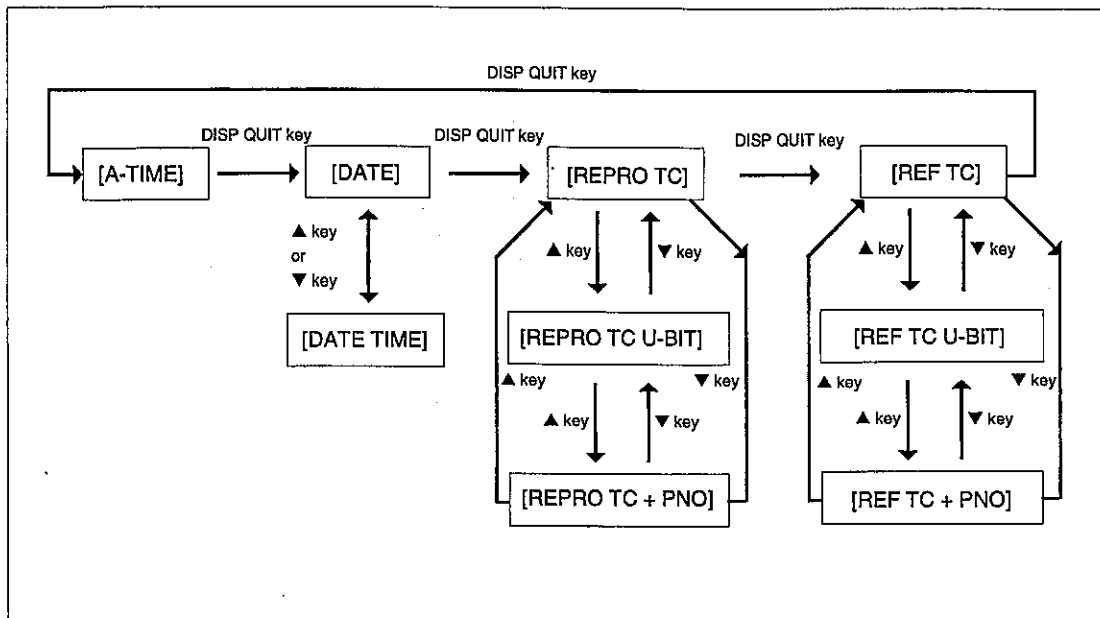

<In the FREE RUN/REC RUN/24H RUN mode>

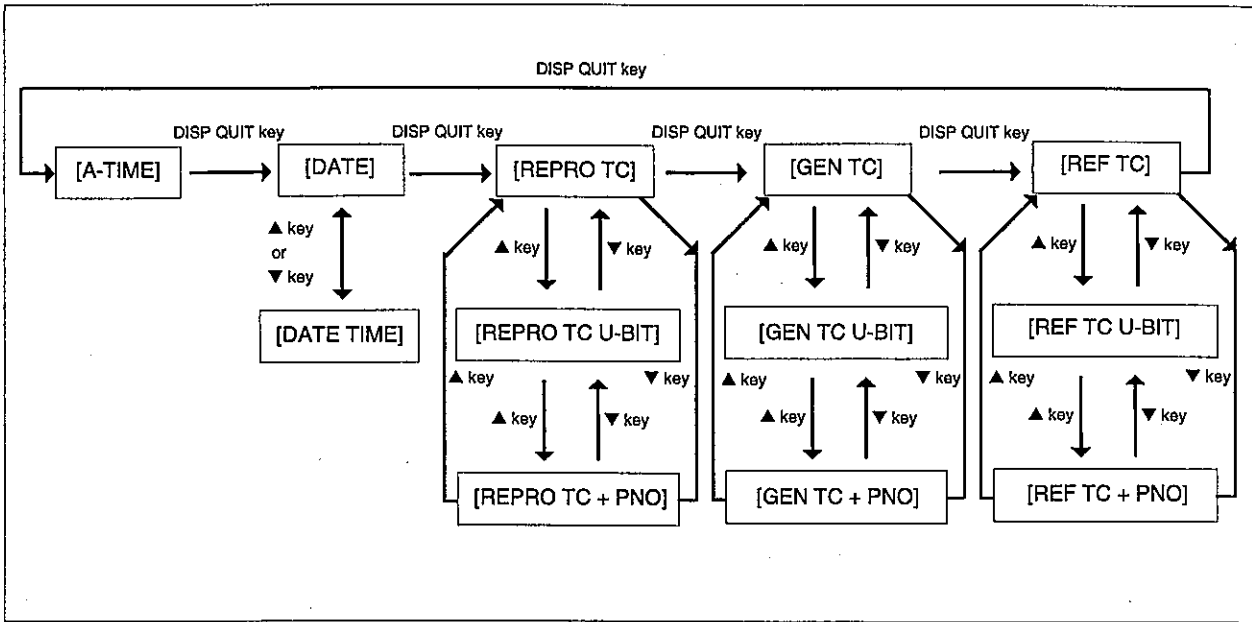

Additional Function

5. Establishing the PCM ERROR Indicator Lighting Level in the SETUP Mode.

In the PD-4 prior to V2.10, the indicator lighting level when a PCM error occurs was fixed at two types - "BER ≥ 1%" (green light) and "BER ≥ 10%" (red light).

After version up, the green light "BER ≥ 1%" lighting level only can be set to different level (the red lighting level is not changed).

This function is newly added in the SETUP mode as set number "SU 117" and the level can be selected and set from the following three types (* indicates the initially set figure).

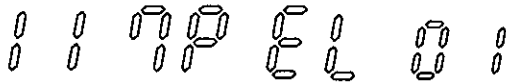

117PEL-00	Lighting level 1%
117PEL-01(*)	Lighting level 3%
117PEL-02	Lighting level 5%

Extended Function

6. Extension of Error Tone Function.

Any error occurring during operation of the PD-4 is indicated by the recorder emitting an error tone. In the previous PD-4, when the corresponding error for sounding the tone occurs, the same burst tone signal was used.

Now, this function has been extended to two types of error tones.

Due to this, the type of error that has occurred can be easily recognized upon hearing the error tone. The two types of error tones are as follows:

Error tone content	Content of warning
<p>Beep Beep Beep Beep</p> <p>← 0.5 sec. → ← 0.5 sec. →</p>	Warning is sounded at voltage failure of the internal NP-1B battery or remaining tape time becomes less than five minutes.
<p>Beep Beep</p> <p>← 0.5 sec. → ← 0.5 sec. →</p>	Warning of other failures (PCM error, overload, etc.)

<NOTE>

This error tone feature will not function unless the SETUP mode "SU 110" is preset to "01" or "02" (Refer to supplement of Version 1.03 of the Owner's Manual for details on the SETUP mode "SU 110").

Extended Function

7. Functional Extension in Lighting Time of the Display Back Light.

Lighting time of the display back light upon pressing the LIGHT key has been extended for more easy reading of the display.

The function is extended as follows.

Before version up;
The light will burn for two seconds upon pressing the LIGHT key, then be extinguished. It will continue to burn if the LIGHT key is held down for more than three seconds and the LIGHT key is pressed again to extinguish it.
After version up;
Lighting time has been extended to four seconds at one pressing of the LIGHT key. It will continue to burn if the LIGHT key is held down for more than three seconds and the LIGHT key is pressed again to extinguish it.

Extended Function

8. Functional Extension in Setting the PAUSE Mode Release Time.

Refer to "release time" added to the SETUP mode in V1.03 has been further version upped and release time of 10 and 20 minutes have been newly added (Refer to supplement of Version 1.03 of the Owners Manual).

As a result of this, it is now possible to select the pause release time from the following items (* indicates the initial setup figure).

00	Pause release time 30 seconds
01	Pause release time 1 minute
02	Pause release time 2 minutes
03 (*)	Pause release time 3 minutes
04	Pause release time 4 minutes
05	Pause release time 5 minutes
06	Pause release time 10 minutes (New addition)
07	Pause release time 20 minutes (New addition)

Additional Function

9. Muting the Internal Speaker Output in the SETUP Mode.

Mute ON/OFF of the PD-4 internal monitor speaker during recording has been newly added as number "SU 116" in the SETUP mode (Mode number is "116 rMM-00").

As a result of this, it is now possible to select the previous "SU 411" for method in entering the SETUP mode and setup procedure.

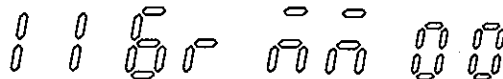

116 rMM-00 (*)	Mute function OFF
116 rMM-01	Mute function ON

PD-4 Owner's Manual Supplement
<Version 2.0>

The following functions have been added concurrent to version up of the PD-4 software. Since only the additional functions and changes in the content are explained here, please read this together with the Owner's Manual for basic operating procedures.

<Additional functions>

1. TC backup function when replacing the battery.
2. New functions added to the mic attenuator.
3. Slate tone oscillator is added.
4. Remote control function is added.

The locations where the new functions have been provided are shown in the following schematics.

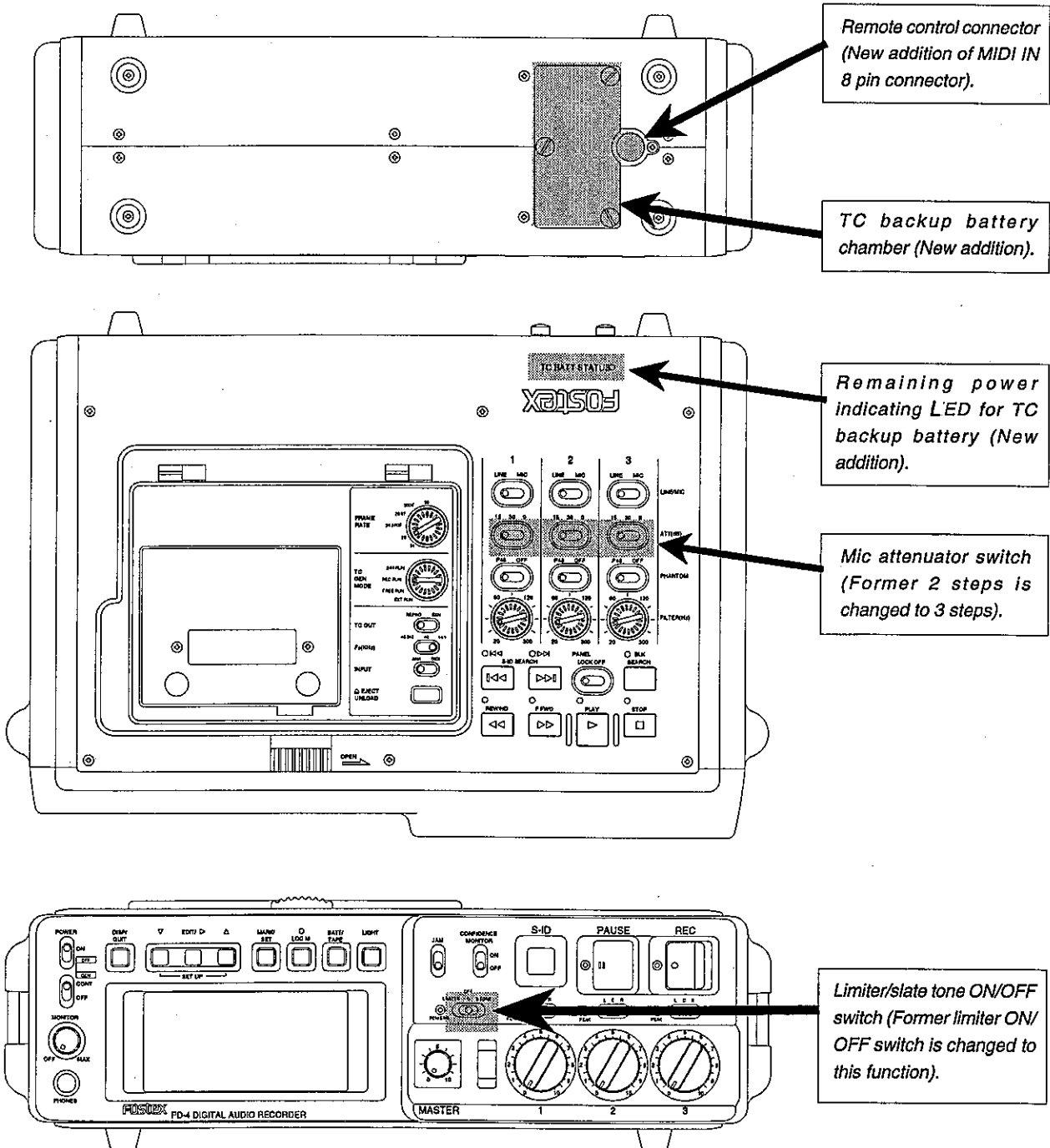

<Additional function 1>

A time code backup function when replacing the battery (NP-1B) has been added.

<Explanation>

During operation of the PD-4, backup of the time code generated by the PD-4 internal TC generator when replacing the exhausted external battery (NP-1B) is now possible. For this purpose, type AA (UM-3 x 2) dry cells are used for the backup power source and the TC GEN CONT mode (power saving mode) of the version up 2.0.

When this function is used, the exhausted battery can be replaced while running the time code at crystal accuracy (time code backup) during operation it in the field on an external NP-1B battery. Please read the following notes carefully and correctly follow the procedures outlined in the next page to change the battery.

<NOTE 1>

The remaining power of the backup battery can be checked using the PD-4 top panel TC BATT STATUS LED. This LED works only when the GEN CONT mode switch is ON and the PD-4 POWER switch is OFF, and the lighted, blinking or extinguished state of this LED is indicating the following conditions and thus can give you an idea as to when to replace the battery.

Lighted	Battery voltage is sufficient.
Blinking	Voltage is low. Replace with new batteries.
Extinguished	Immediately replace with new batteries.

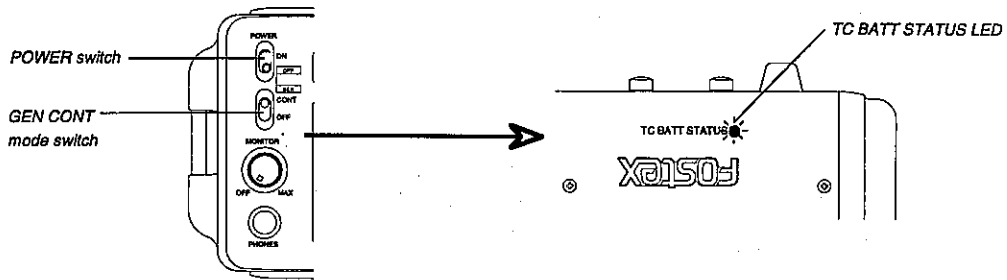

In addition to checking the above LED to judge battery replacement, refer to the following list for a rough measure of a replacement schedule. This list for is based on the assumption that the NP-1B should be replaced four times each day and that it will require 5 minutes each time.

This list, however, should be referred to only as a rough measure since these figures could vary depending on the operating condition of PD-4 and different types of batteries.

Type of battery	Days of operation (Measure of replacing)
Alkali cell	4 days
Manganese cell	1 day
Nickel cell	3 days

We recommend alkali cells for frequent use of the PD-4 under normal or high temperatures, and the nickel-cadmium cells for frequent use under low temperatures.

The following list is compiled with reference to experimental results obtained under these temperature conditions. These are the time measured until reset of the TC generator while continuously operating it in the GEN CONT mode with the battery.

Temp	+50°C	+25°C	0°C	-20°C
Alkali ①	3h16m30s	1h38m00s	18m00s	03m00s
Alkali ②	2h37m30s	1h07m30s	18m45s	00m56s
Manganese	-----	0h13m00s	01m30s	-----
NiCd	1h18m45s	1h12m45s	57m00s	35m15s

<NOTE 2>

Do not leave batteries inside PD-4 for long idle periods. Chemical fluids leaking from old batteries could damage the equipment. Be sure to remove batteries from the PD-4 if it will not be used for some time.

<NOTE 3>

****IMPORTANT****

If the main power supply (NP-1B or AC adaptor) is not connected to the PD-4 main unit with only backup batteries installed, DO NOT switch ON the power to the PD-4 if the GEN CONT mode switch is ON. If you do, the backup batteries will be lost.

<NOTE 4>

When using a chargeable type backup battery, be sure it is fully charged. Since this equipment is not designed to charge a battery, a separate charge must be used for charging.

<Operating Procedures of the Backup Function>

1. Loading the backup batteries (UM-3)

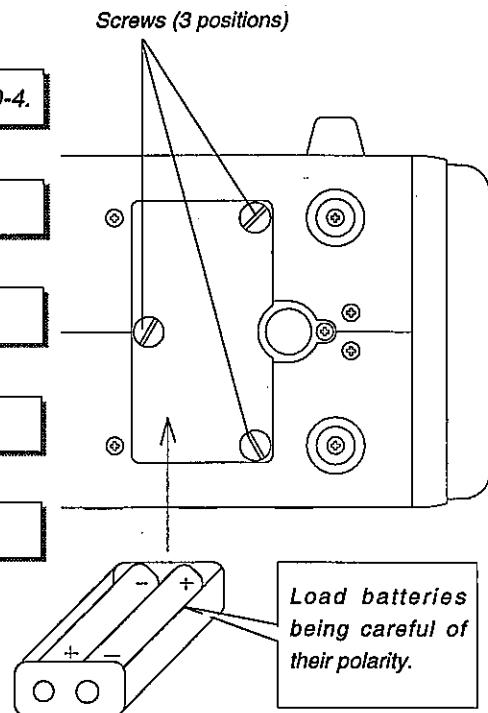
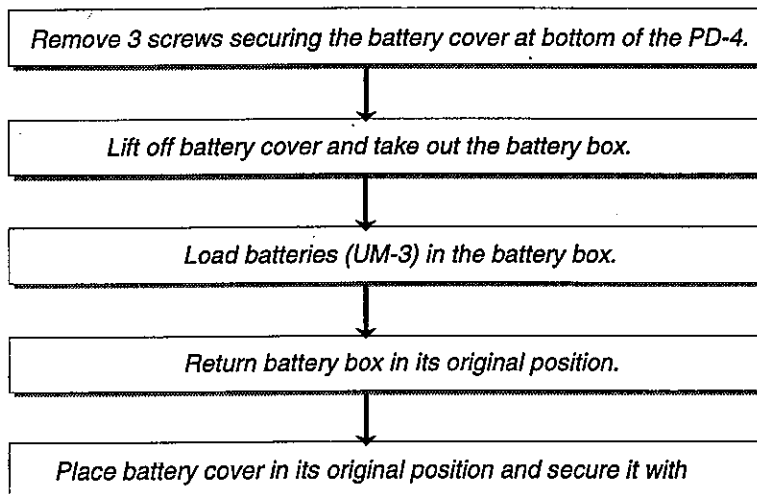

2. Before using the backup function (Be sure to heed this !)

Before using the PD-4, always be sure to check the TC backup batteries for sufficient voltage using the procedures outline below.

- ① Switch OFF the PD-4 POWER, then switch ON the GEN CONT mode switch.
- ② Disconnect the main power supply (NP-1B or AC adaptor) from PD-4.
- ③ Check that the TC BATT STATUS LED is lit when the main power supply is disconnected. Should the LED blink or be extinguished when disconnected, replace with new batteries and repeat this check.

3. Replacing the batteries using the backup function

Should NP-1B become exhausted during operation of PD-4 (Refer to page 23 on the PD-4 Owner's manual for battery remaining power indication.)

Discontinue operation of the PD-4, and after switching ON the GEN CONT mode switch, switch OFF the power supply. (As it will enter the GEN CONT mode, make sure that the TC BATT STATUS LED is lit.) If it is blinking or it is extinguished, replace the batteries and proceed to the next step.

Replace the exhausted NP-1B with a fully charged NP-1B.

Switch ON power to start PD-4. After this, check that TC has not been RESET, then proceed to normal operation.

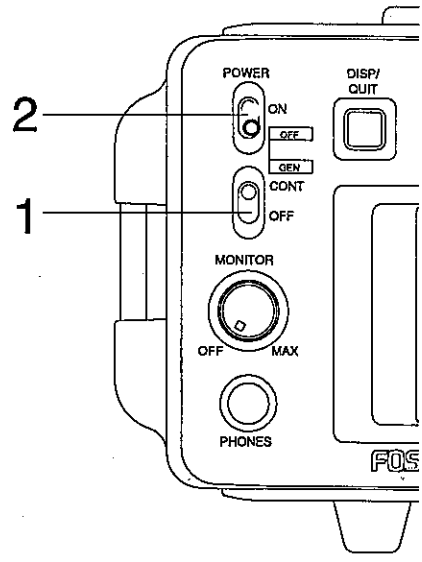

<CAUTION>
When replacing the batteries using the TC backup function, carefully note the backup battery remaining power. In the above operation, should the NP-1B be removed from the PD-4 without confirming that the backup battery is exhausted, in some cases the TC BATT STATUS LED may suddenly start blinking. This occurs due to a sudden drop in battery voltage caused by the sudden increase in load on the backup battery when the NP-1B is removed. If this happens, immediately carry out either one of the following procedures to avoid this condition.

1. After quickly replacing NP-1B, load new dry cells (UM-3).
2. Return the removed NP-1B in its original position and after replacing with new dry cells (UM-3), replace NP-1B according to the above procedures.

<Additional function 2>

Functional improvement of the mic attenuator

<Explanation>

The mic attenuator has been changed from the former number two step (20/0dB) switching to increased steps and change in level figures, and is now switchable in three steps of 15/30/0dB. As a result, it now complies to more critical input levels. It can now meet most requirements of the mic used in various field condition. The mic attenuator works only when the LINE/MIC selector is set to MIC.



<Additional function 3>

Slate tone oscillator

<Explanation>

A 1kHz slate tone oscillator (LIMITER/S. TONE ON/OFF switch) which is convenient for level matching with externally connected equipment, such as when analog recording to external equipment using the PD-4, is newly installed. Because this oscillator can be switched between the input at the stage prior to the MASTER level control knob, the level between the external equipment connected to the PD-4 ANALOG OUT connector can be matched with the PD-4 level meter.

<Operating procedures>

Check to be sure the INPUT switch is set to ANA (Analog).
Should it be set to DIGI (Digital), switch it to ANA.

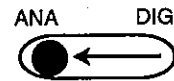

Set the PD-4 front panel LIMITER/S. TONE switch to S. TONE (right edge). (The input will switch over to the 1kHz tone.)

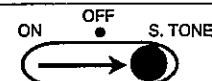

Rotate the MASTER level control knob and set it to the REFERENCE LEVEL of the level meter. Match it to any external equipment level at the same time. When a +4dBu slate tone is output from the ANALOG OUT connector, the MASTER level control knob will be at approximately 6.5 ~ 7.5.

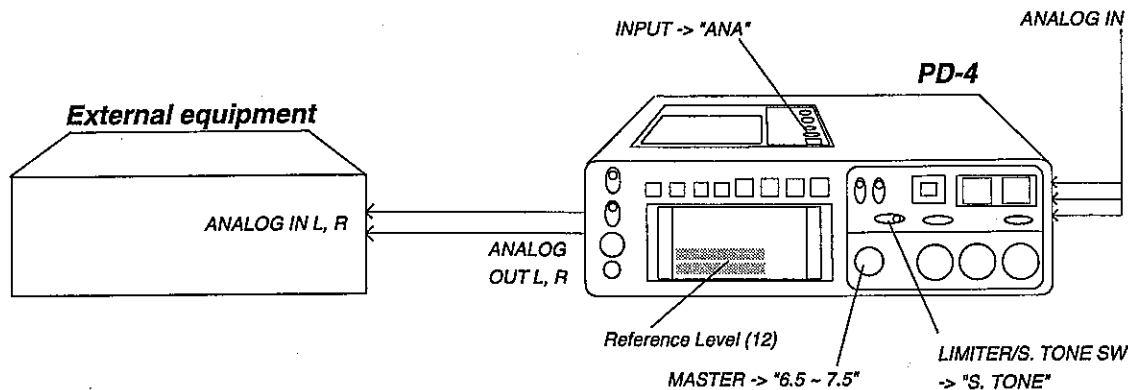

<Additional function 4>

Remote control connector is installed

<Explanation>

A MINI DIN 8 pin parallel remote control connector has been installed to allow control of this equipment from a remote location. By utilizing this connector, the PD-4 can be remote controlled in the following ten different types of operation (As shown below, this connector is installed at the bottom of PD-4).

Remote controllable operations			
1	PLAY	6	BLANK SEARCH
2	STOP	7	S-ID recording
3	RECORD	8	PAUSE
4	REWIND	9	S-ID SEARCH (◀◀)
5	F. FOWARD	10	S-ID SEARCH (▶▶)

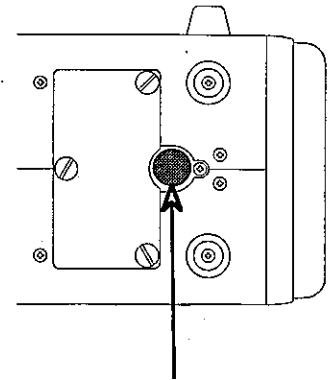

MINI DIN 8pin connector

<Operating procedures>

Each mode will be activated when the corresponding pin is connected to GND. Because this connector is not related to the PD-4 main unit PANEL LOCK key, remote control will be active even though the PANEL LOCK key may be set at "LOCK." The pin assignments of this connector are as follows:

Pin assignment

1 pin	PLAY	5 pin	SHIFT
2 pin	STOP	6 pin	REWIND
3 pin	RECORD	7 pin	V BATT (DC12 ~ 16V) Max. 500mA (*)
4 pin	GND	8 pin	F.FOWARD

(*) At switch ON of power, this will be output when in the GEN CONT mode.

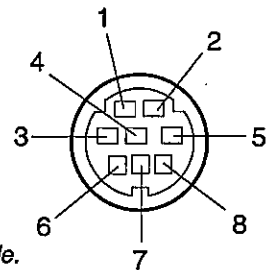

[SHIFT + PLAY]	BLANK SEARCH
[SHIFT + STOP]	S-ID recording
[SHIFT + REC]	PAUSE
[SHIFT + REW]	S-ID SEARCH (◀◀)
[SHIFT + FF]	S-ID SEARCH (▶▶)

<PRECAUTION>

Because pin #7 (DC12 ~ 16V) is the main power line, the PD-4 main unit's battery life will be shortened or might cause unusual heating if it is short - circuited to GND or a large load is applied to it. Therefore, apply as small a load as possible during operation and absolutely DO NOT short circuit this to GND.

(Example): Battery life will be about half if 500mA is drawn from it.

PD-4 Owner's Manual Supplement
<Version 1.04>

PD-4 System Software Upgrade Version 1.04

This document explains the changes and additions that have been made in Version 1.04 of the PD-4's system software. Please use this supplementary document in conjunction with your *PD-4 Owner's Manual*.

Changes and additions summary:

1. The mode display for a sampling rate of 48.048 kHz has been changed.
2. The SETUP mode list has been changed from automatic to manual display.
3. Automatic recording restart for Digital In signal interruption has been added.

1. 48.048 kHz Mode Display

Previously, when the 48.048 kHz sampling rate (48 kHz with 0.1% pull up) was selected, just the "48 kHz" indicator blinked on the display. With the new version, however, the "48 kHz" and "0.1%" indicators both blink, as shown below.

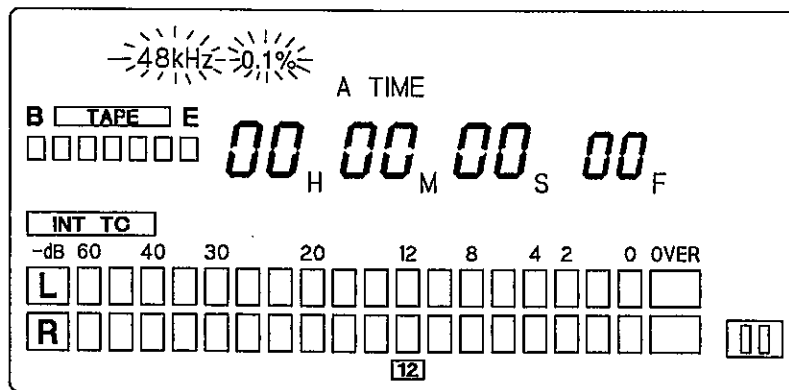

2. SETUP Mode Display

Previously, the SETUP Mode Quick List display function, which is explained on page 52 of the *Owner's Manual*, was automatically displayed by continuously pressing the LIGHT key, even after the power was switched on. With the new version, however, this has been changed to a manual operation whereby you must press the ▲ and ▼ keys while continuously pressing the LIGHT key.

To check the SETUP Mode Quick List, press and hold down the LIGHT key and power ON the PD-4, then while still pressing the LIGHT key use the ▲ and ▼ keys to view the list. The contents of the SETUP Mode Quick List are shown alternately with each press of the ▲ and ▼ keys. Refer to the "V1.03 Supplemental Edition" as the contents of the Quick List were changed in that version.

When the LIGHT key is released, the display returns to normal.

3. Automatic Recovery for Digital In Recording

Previously, if the Digital In signal was interrupted during recording, the Recording mode was cancelled. With the new version, however, Recording mode is not be cancelled. The PD-4 enters REC-PAUSE Standby mode. Furthermore, it automatically restarts recording if the Digital In signal recovers.

The REC-PAUSE Standby mode is indicated by the following front panel indicators.

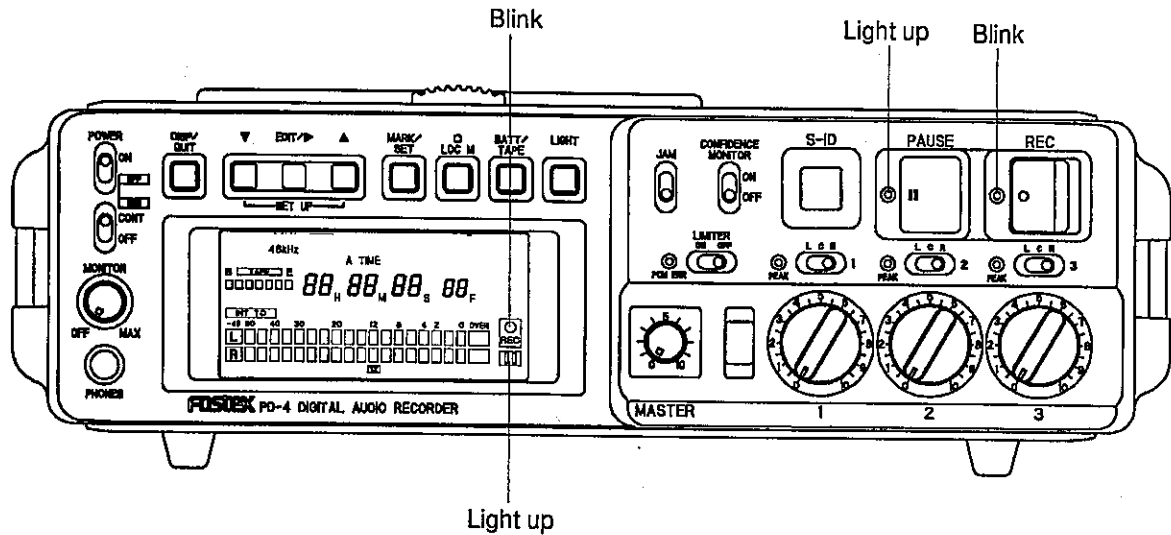

PD-4 Owner's Manual Supplement
<Version 1.03>

Additions to the PD-4 Owner's Manual

In relation to version up (V1.03) of the PD-4 software, the following items were added in the SETUP mode of this equipment. As the newly added functions are explained only here, please read this together with the main text.

SETUP mode additional functions

1. Setup of the pause mode disengage time [SU 104] (New addition)

Previously, the pause mode disengage time was fixed at 3 minutes but with addition of "SU 104" in the SETUP mode, the disengage time can be set to several different lengths.

Time setting can be selected from 30 seconds, 1, 2, 3, 4 and 5 minutes by their assigned numbers as listed below (Initial setting is "03.")

10 4P c 7 03

00	Disengaged after 30 seconds.
01	Disengaged after 1 minute.
02	Disengaged after 2 minutes.
03 (*)	Disengaged after 3 minutes.
04	Disengaged after 4 minutes.
05	Disengaged after 5 minutes.

2. Two items on output conditions and the setup mode "02" [SU 110] are added to the ON/OFF setting of error tone output.

When the mode is set to "01" (ON) the error tone output conditions are THE TAPE REMAINDER WHEN RECORDING BECOMES LESS THAN 5 MINUTES and WHEN EXT TC IS INTERRUPTED. These have been added and an error tone will now be output for about 3 seconds when either one of the output conditions have been met.

Furthermore, "02" has been added to the setup mode in which the error tone can be made to sound only when the recording tape remainder becomes less than 5 minutes and when the power supply voltage is erroneous. Details on the setup numbers are as follows (Initial setting is "01.")

11 0E 7n 01

00	ALL OFF
01 (*)	ON (Output when BATT LOW, TAPE REMAIN, PEAK OVER, BER ERR, EXT TC OFF)
02	ON (Output only when BATT LOW, TAPE REMAIN)

3. Setup of the level meter peak hold time [SU 112] (New addition)

Level meter of this equipment can be set to any peak hold time.

The setting can be selected from among ten types - from peak hold ON (Nine types in one second intervals from 1sec. ~ 9sec.) and peak hold OFF.

The setup numbers are listed below (Initial setting is 3sec.)

11 2P H7 03

00	Peak hold OFF.
01	Peak hold ON (1sec.)
02	Peak hold ON (2sec.)
03 (*)	Peak hold ON (3sec.)
04	Peak hold ON (4sec.)
05	Peak hold ON (5sec.)
06	Peak hold ON (6sec.)
07	Peak hold ON (7sec.)
08	Peak hold ON (8sec.)
09	Peak hold ON (9sec.)

4. Setting the PAUSE key function [SU 113] (New addition)

The PAUSE key function can be changed.

Normally, the PAUSE key has only the PAUSE MODE ON function, but with addition of SETUP mode "SU 113" it will alternate between PAUSE - STOP with each press of the PAUSE key.

Either "00" or "01" can be selected for the setting and details on the setup numbers are as follows (Initial setting is "00.")

11 3P 5n 00

00 (*)	PAUSE function only.
01	Alternates between PAUSE - STOP.

5. Setting the LIMITER switch function [SU 114] (New addition)

The LIMITER switch function can be changed.

Previously, the LIMITER switch was effective when the MIC/LINE selector switch was set to MIC for more than one channels, but with addition of the SETUP mode "SU 114" it will become effective even when all MIC/LINE switches are set to "LINE."

Although the initial setting is "00" (only at selection to "MIC"), if it is set to "01" as necessary, the LIMITER function will be active even when "LINE" is selected. Details on the setup numbers are as follows.

11 4L 1n 00

00 (*)	Functions only when "MIC" is selected.
01	Functions for both "MIC" and "LINE."

6. Changes in the SETUP mode display at power ON

The various SETUP modes displayed at power on with the LIGHT key pressed have been changed as follows. The SETUP modes are displayed consecutively for as long as the LIGHT key is pressed.

LCD display	Range of SETUP display	SETUP modes effective in PD-4
XX- - - - 10	105 ~ 100	105, 104
- - - X10	109 ~ 106	106
- XXXXX11	115 ~ 110	114 ~ 110
- - - XX- 20	205 ~ 200	202, 201
- - X- X- 40	405 ~ 400	403, 401
- X- - 40	409 ~ 406	408

"X" indicates setup figures from 0 to 9 for each SETUP mode.

"-" indicates SETUP modes not supported by present version of PD-4.

Fostex PD-4 DIGITAL AUDIO RECORDER

Precautions	3
Condensation	4
Memory back-up battery	4
Note for replacing the ROM	4
Introduction	5
Features of the PD-4	5
Applications	6
Controls & Connections	7
Tape compartment controls	8
Transport controls	9
Mixer controls	11
Edit and setup controls	13
Power and other controls	15
Input connectors	16
Output connectors	17
LCD panel	18
Initial procedures	22
Using the external power supply	22
Using the internal battery	22
Powering up the PD-4	24
Important notes about using DAT cassettes	24
Input connections	26
Output connections	28
Tape transport controls	29
Recording	32
Setting the sample frequency	32
Microphone input settings	33
Record monitoring	34
Recording audio	35
Recording time code	37
S-ID and P-NO recording	40
Playback	42
Normal playback	42
Cue playback	42
Search functions	42

Other functions	44
Tape remaining	44
Editing the date and time code	44
SETUP mode functions	46
Selecting a SETUP mode function	46
Editing a SETUP mode function	46
Function descriptions	47
SETUP mode functions	51
Error messages	54
Specifications	55
Input/output connector pin assignments	55
Technical specifications	57
Dimensions	59
Glossary	60

Precautions

Avoid excessive heat and humidity

Do not expose the PD-4 to extremes of humidity. Do not place the unit in direct sunlight, close to heating units, or in areas subject to high temperatures. Also avoid areas subject to extremely low temperatures.

The PD-4's ambient operating temperature is between 0° and 45° C.

Avoid excessive dust and vibration

Locations which are subject to excessive dust accumulation or vibration which could cause mechanical damage.

Avoid physical shocks

Strong physical shocks can cause damage. Handle the unit with care.

Avoid damaging the power cord

Make certain that the PD-4's power cord is not located in a position where it is likely to be walked on or pinched by other equipment placed near the cord.

Clean with a soft dry cloth

Never use solvents such as benzine or thinner to clean the PD-4. Wipe it clean with a soft dry cloth. If further cleaning is required, a lightly moistened cloth with a mild detergent may be used.

Do not open the case or attempt repairs or modification yourself

The PD-4 contains no user-serviceable parts. For other than routine cleaning, refer all maintenance to qualified FOSTEX service personnel.

To reduce the risk of electric shock, do not open the case. Opening the case and/or tampering with the internal circuitry will void the warranty.

Condensation

If the PD-4 is moved from a warm environment to a cold environment, condensation may build up on the tape transport. To prevent possible damage to the transport and the DAT cassette, a dew sensor automatically stops all transport operation.

When the dew sensor is active, the DEW indicator (59) will flash on the display.

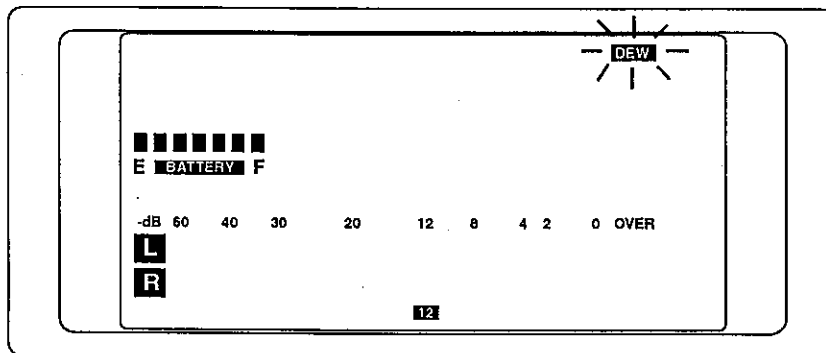

Figure 1
Dew indicator

When the condensation has dried, the DEW indicator will no longer be flashing on the display and the tape transport will resume operation.

IMPORTANT! All keys other than the EJECT/UNLOAD key are inactive while the dew sensor is active. Wait until the DEW indicator is no longer illuminated before attempting any operations.

Memory back-up battery

In addition to the main battery, the PD-4 contains a memory back-up battery. This battery protects the memory data while the main battery is being replaced. The back-up battery automatically charges when the PD-4 is powered up.

During periods of non use, the memory data will be maintained for two months, if the unit is stored at room temperature. When you turn the power on after the back-up battery has discharged, the memory will reset to the factory default settings.

To maintain the memory data, power up the PD-4 for 24 hours at least once every two months. A fully discharged memory back-up battery requires 24 to 48 hours of charging.

Note for replacing the ROM

When you replace the ROM to update the system version, please note the following:

Before replacing the ROM, be sure to remove the internal battery (NP-1B) and unplug the external power source (AC adaptor AD-15) from the AC outlet. If you replace the ROM without removing the battery or disconnecting the AC power, the ROM may be damaged, or the PD-4 may malfunction.

IMPORTANT! You should have the ROM replaced at an authorized FOSTEX service centre.

FOSTEX PD-4 DIGITAL AUDIO RECORDER

Introduction

FOSTEX has produced many different models of professional DAT recorders, including the very successful and popular D-10, D-20 and D-30 mastering recorders and the PD-2 portable professional audio recorder. The PD-4 is the latest generation portable professional digital audio recorder from FOSTEX.

The PD-4 is a professional DAT recorder designed as a low-cost solution for film, video, and TV location recording. It is intended for applications where high-quality audio with embedded time code are essential requirements. It has many features to support this complex and demanding role:

It contains a three-channel microphone mixer to lighten the equipment burden even further.

Its four-head design allows confidence monitoring of the recorded audio.

It has a very flexible and powerful time code facility. It can be synchronized to another device and then detached, running the time code independently with crystal clock accuracy.

The PD-4 easily provides all this capability in a lightweight and user-friendly machine.

Like all FOSTEX equipment, the PD-4 has been designed and built to meet the exacting requirements of the professional sound engineer. The PD-4 will give you years of outstanding performance, whatever your creative application.

Features of the PD-4

- Two 16-bit digital audio channels.
- Four-head design allows confidence monitoring (simultaneous recording and playback) of audio data.
- Record and playback capabilities of SMPTE/EBU time code, IEC format.
- Compatible with all DAT recorders.
- Three sample frequencies: 48 kHz, 48.048 kHz, and 44.1 kHz.
- The PD-4 generates time code using a crystal clock. This offers improved flexibility in time code applications, allowing independent operation of the unit.

The internal battery can be replaced without interruption of the internal time code synchronization.

- Includes a three channel mixer to enable the recording of voice plus a stereo background at a remote location without having to carry an external mixer.

Each channel of the mixer has a L C R panpot switch, 48V DC phantom power, continuously variable high-pass filter, and 20 dB microphone attenuation.

- Full-logic transport to prevent errors in operation.

Fostex PD-4 DIGITAL AUDIO RECORDER

- Digital data transfer using either consumer (SPDIF) or professional (AES/EBU) data formats (IEC 958).
- Sound monitoring by stereo headphones or the built-in loudspeaker. The headphone jack switches between the two.
- Rugged but lightweight portable construction.

Applications

Although the PD-4 has been designed primarily for location recording, you can use it in virtually any application that requires DAT recording. Some applications are listed below:

- A direct replacement for existing 1/4" analog recorders.
- Location recording for film.
- Electronic News Gathering (ENG).
- Electronic Field Production (EFP).
- A stand-alone professional DAT recorder with time code.
- Gathering sound effects for use with a digital sampler (MIDI/SMPTE, etc.).
- Back-up of DAT cassettes using the digital inputs and outputs.
- Synchronization of PCM audio to video or DAT frames.
- Playback of existing recorded material.

Fostex PD-4 DIGITAL AUDIO RECORDER

Controls & Connections

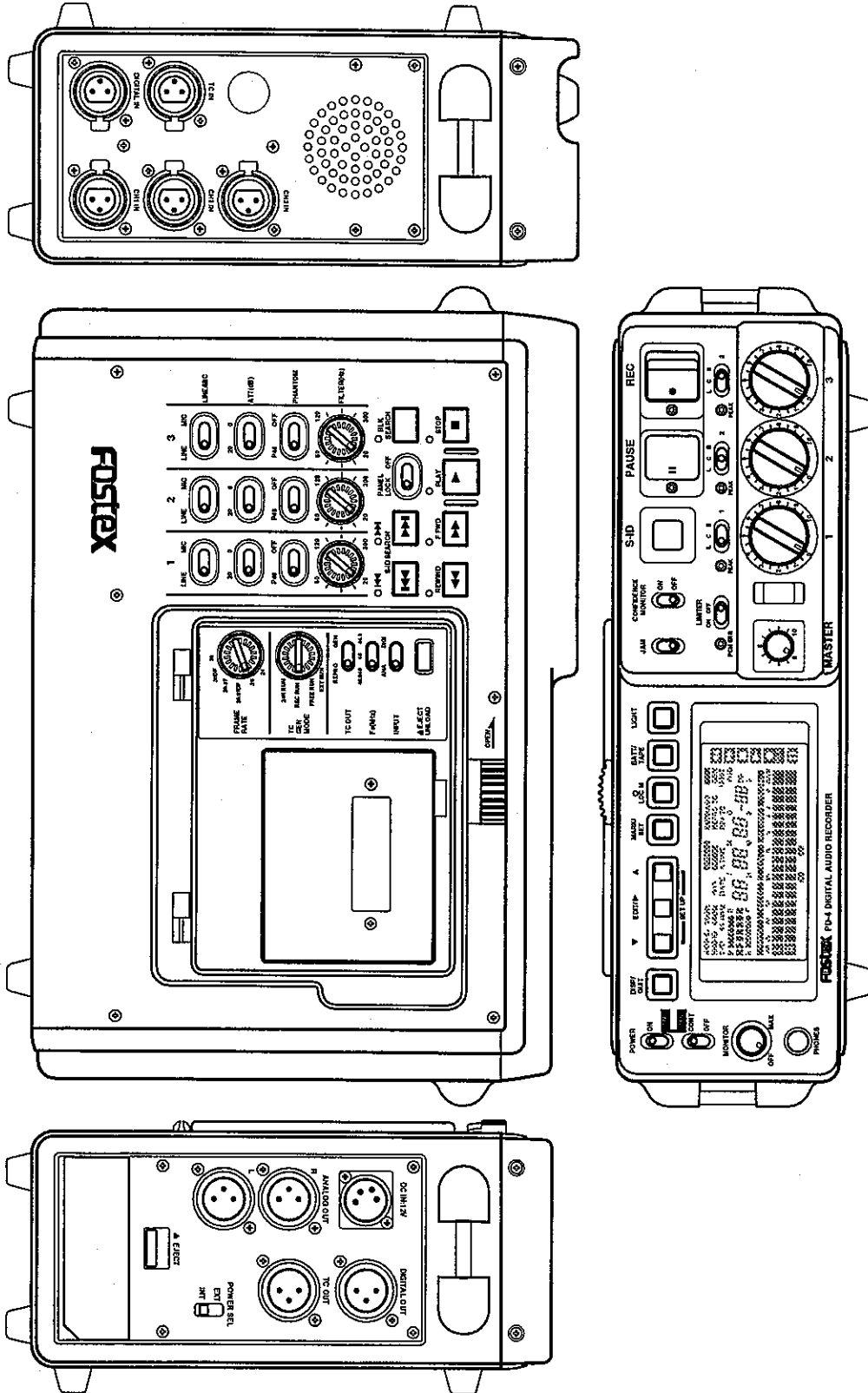

Fostex PD-4 DIGITAL AUDIO RECORDER

Tape compartment controls

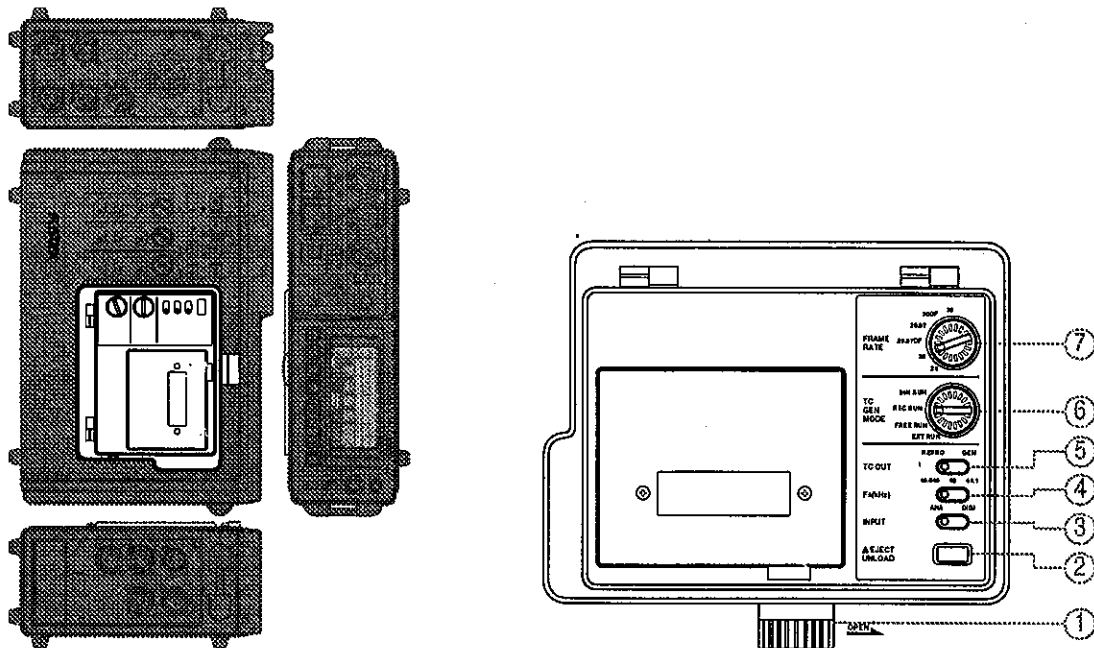

Figure 2
Tape compartment controls

1) **Cover-open lever**

The protective cover will open when this knurled lever is slid sideways to the right.

2) **EJECT/UNLOAD key**

The tape is unloaded when this key is pressed once. When the tape is unloaded, the hard brake (reel lock) is applied. The STOP LED (15) flashes during the unload operation.

The tape is ejected when this key is pressed a second time.

This key is only effective in STOP and PAUSE modes.

3) **INPUT switch**

This switch selects ANA (analog) or DIGI (digital) audio input. The operation is executed only when the PD-4 is in STOP mode.

Note: The time code generator may produce incorrect timing data when you switch between the analog and digital settings. This is because the master clock is also switched.

4) **Fs(kHz) switch**

This switch selects the sampling frequency. The PD-4 can be switched between three sample rates: 48 kHz, 44.1 kHz, and 48.048 kHz.

Fostex PD-4 DIGITAL AUDIO RECORDER

5) TC (Time Code) OUT switch

This switch selects the source of the time code that is to be output through the TC OUT connector. GEN selects the internal clock. REPRO selects the time code specified by the SETUP mode functions 403 and 408 (see page 49).

6) TC GEN MODE selector switch

This rotary switch is used to select the time code type. You can select from the following types:

24H RUN / REC RUN / FREE RUN / EXT RUN

The JAM key (40) can be used to synchronize the internal generator to external time code. See page 37 for details.

7) FRAME RATE selector switch

This rotary switch is used to select the time code frame rate of the internal generator. You can select from the following frame rates:

30 / 30DF / 29.97 / 29.97DF / 25 / 24

This switch can be overridden during playback by SETUP mode function 401. See page 49 for details.

Transport controls

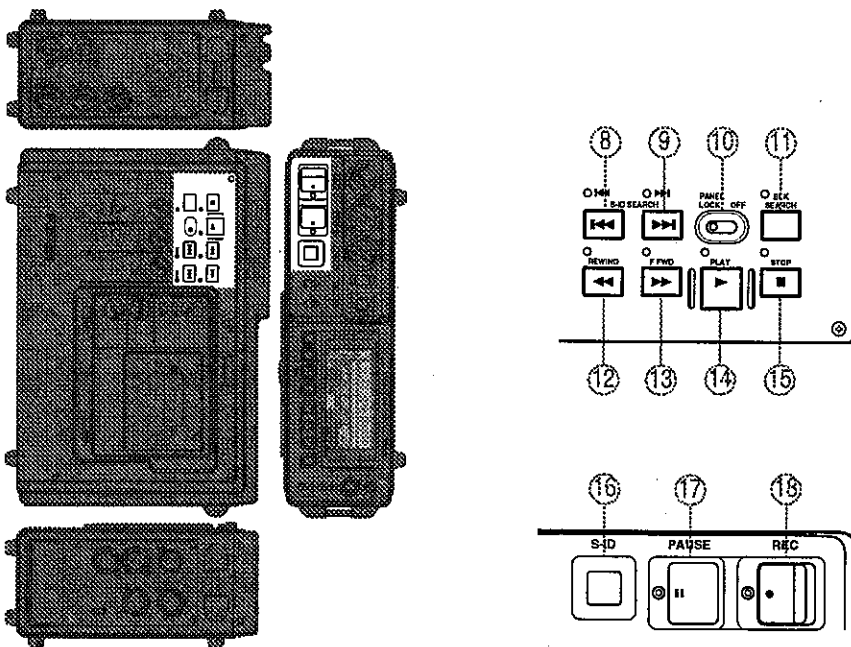

Figure 3
Transport controls

8) ◀◀ S-ID SEARCH key and LED

The PD-4 will search for a specified S-ID (start id) in the reverse direction. The LED illuminates during the search. If you press the PLAY key during the search, the PD-4 will switch to PLAY mode after the operation has completed.

This key is not effective in RECORD mode.

9) ▶▶ S-ID SEARCH key and LED

The PD-4 will search for a specified S-ID in the forward direction. The LED illuminates during the search. If you press the PLAY key during the search, the PD-4 will switch to PLAY mode after the operation has completed.

This key is not effective in RECORD mode.

10) PANEL LOCK switch

This switch disables the following keys:

PLAY, STOP, F FWD, REWIND, BLANK SEARCH, S-ID SEARCH (reverse and forward), and LOC M.

11) BLANK SEARCH key and LED

When this key is pressed, the PD-4 will search for an END-ID or the blank section of tape after the last recording. The LED illuminates during the search. This key is not effective in RECORD mode.

12) REWIND key and LED

This key starts REWIND mode. Press once for slow (×5) or twice for fast (×100). At slow rewind, the PD-4 will be in CUE mode. The PLAY (14) and REWIND LEDs illuminate while the PD-4 is in slow wind (×5). The REWIND LED illuminates while the PD-4 is in fast wind (×100).

This key is not effective in RECORD mode.

13) F FWD key and LED

This key starts FAST FORWARD mode. Press once for slow (×5) or twice for fast (×100). At slow fast forward, the PD-4 will be in CUE mode. The PLAY and F FWD LEDs illuminate while the PD-4 is in slow wind (×5). The F FWD LED illuminates while the PD-4 is in fast wind (×100).

This key is not effective in RECORD mode.

14) PLAY key and LED

The PD-4 will enter PLAY mode when this key is pressed. The LED illuminates green during playback and red during recording.

This key is not effective in RECORD mode.

15) STOP key and LED

This key alternates between PAUSE and STOP modes. Each time the key is pressed, the mode changes. In STOP mode, the hard brake (reel lock) is applied. The LED illuminates while the PD-4 is in STOP mode. The LED flashes during the unload operation.

The PAUSE LED (17) illuminates in PAUSE mode. This key is not effective in RECORD mode.

Fostex PD-4 DIGITAL AUDIO RECORDER

16) S-ID key

When this key is pressed during RECORD mode, 300±30 frames of S-ID/P-NO will be recorded. See page "S-ID and P-NO recording" on page 40.

This key is only effective in RECORD mode.

17) PAUSE key and LED

This key will pause recording. The LED illuminates while the PD-4 is in PAUSE mode.

To protect the tape, PAUSE mode will be cancelled automatically after three minutes and STOP mode will be engaged.

18) REC key and LED

The PD-4 will enter RECORD mode when this single-action, slide-type key is activated. The LED illuminates during recording.

The REC key is ineffective if the write protect tab on the cassette tape is opened.

Mixer controls

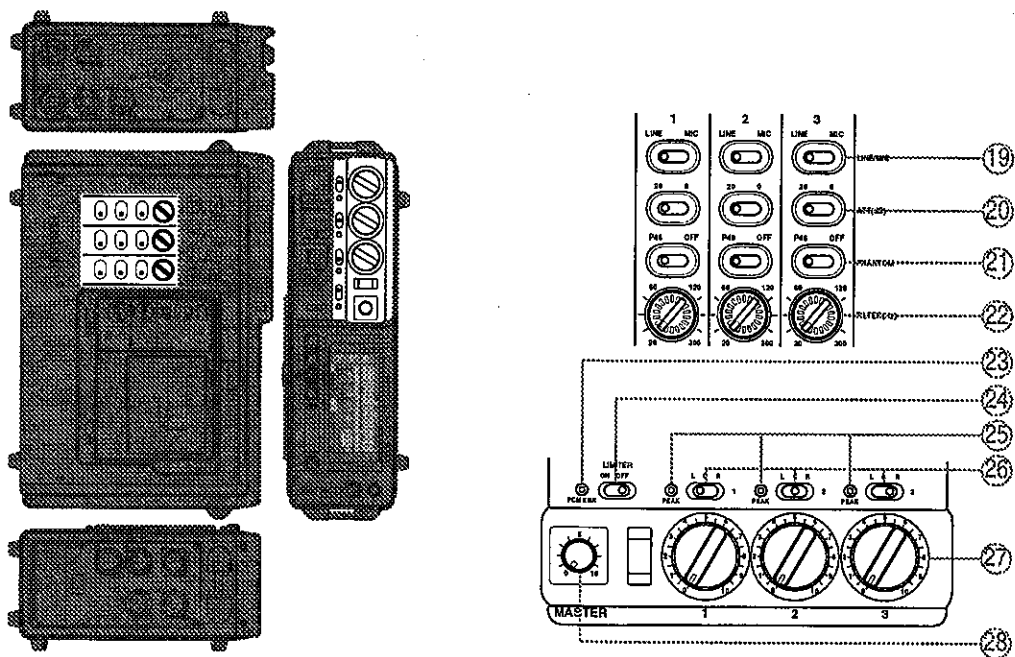

Figure 4
Mixer controls

19) LINE/MIC switches (channels 1 to 3)

These switches select between LINE or MIC (microphone) signal levels for the analog input connectors.

20) ATT (dB) switches (channels 1 to 3)

These switches attenuate the microphone signal level. Select 20 (20 dB attenuation) or 0 (no attenuation).

Fostex PD-4 DIGITAL AUDIO RECORDER

These switches are only effective when the corresponding LINE/MIC switch (19) is set to the "MIC" position and a microphone signal is input.

21) PHANTOM switches (channels 1 to 3)

These switches select the phantom power supply for the analog input connectors. Select P48 (48V DC) or OFF.

These switches are only effective when the corresponding LINE/MIC switch is set to the "MIC" position and a microphone signal is input.

22) FILTER(Hz) controls (channels 1 to 3)

These rotary controls adjust the input filter for the corresponding input. The filter has a continuously variable cutoff frequency from 20 Hz to 300 Hz, with a slope of -12 dB/octave.

These controls are only effective when the corresponding LINE/MIC switch is set to the "MIC" position and a microphone signal is input.

23) PCM ERR LED

This LED will light when a PCM error occurs during playback. It will be illuminated green when the average BER (block/burst error rate) over 8 frames exceeds 1%. It will be illuminated red when the average BER over 8 frames exceeds 10%. The LED will remain illuminated for about 8 frames (240ms) on a momentary error and will remain illuminated during a continuous error.

24) LIMITER switch

This switch turns on the limiter circuit. The INPUT switch (3) must be set to ANA (analog) and the LINE/MIC switch (19) to MIC (microphone).

25) PEAK LEDs (channels 1 to 3)

These LEDs will light when the corresponding input amplifier for the channel is overloaded.

26) L C R (pan pot) switches (channels 1 to 3)

These switches select the stereo position for the input channels. Select L (left channel), C (both channels), or R (right channel).

When you select C (both channels), the input level is reduced by 3 dB.

27) Input controls (channels 1 to 3)

These rotary controls adjust the individual input levels for channels 1 to 3.

28) MASTER level control

This rotary control adjusts the overall input level for both the left and right channels.

Fostex PD-4 DIGITAL AUDIO RECORDER

Edit and setup controls

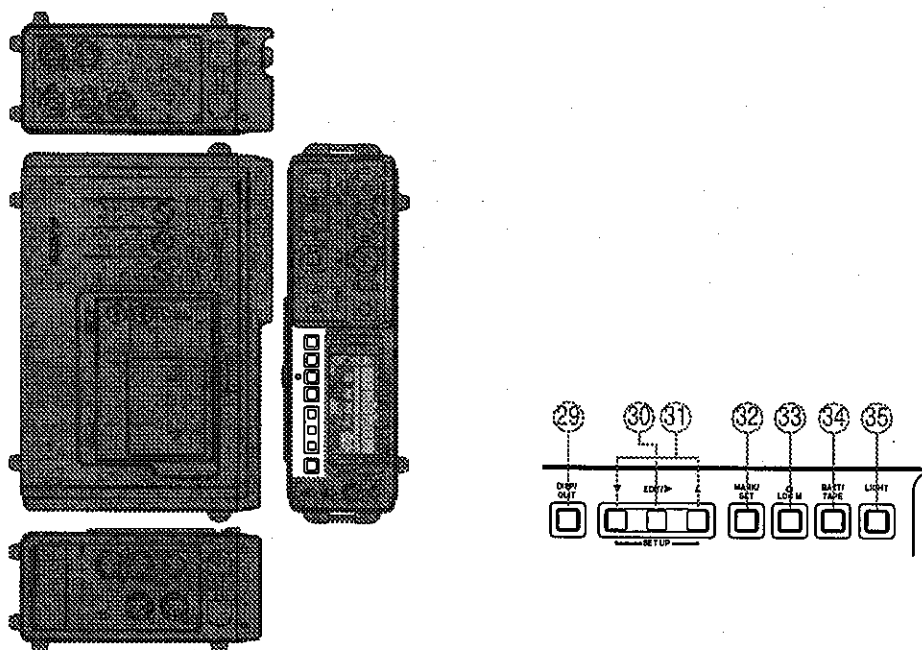

Figure 5
Edit and setup controls

29) DISP/QUIT key

This key is used to switch the time display on the LCD. See page 38 for details.

If you press this key during EDIT mode, the edit will be canceled.

If you press this key during SETUP mode, the PD-4 will advance through each level item and quit after the last item. See page 46 for details.

30) EDIT/▶ key

This key is used to edit the time display. Press once to enter EDIT mode, twice to select the edit point (digit). The DISP/QUIT key (29) cancels this mode. You can edit the following data: A-TIME, REPRO TC, REF TC, GEN, DATE, and GEN UBIT. The GEN and GEN UBIT edit condition varies depending on the TC GEN MODE switch (6) setting as shown in the following table:

FREE RUN	Edit available
EXT RUN	Edit is not available
24H RUN	You can only edit the REEL NO of the GEN UBIT.
REC RUN	You can edit during recording or when a tape without time code data is loaded.

31) ▲ (Up) and ▼ (Down) keys

These keys are used to adjust the values during EDIT mode. The current value (flashing character on the display) will be incremented or decremented. If you hold the

Fostex PD-4 DIGITAL AUDIO RECORDER

key for more than one second, the PD-4 will auto increment/decrement the current value. When the display shows the date, "Y.M.D" and "H.M.S" will be indicated in turn.

Press both keys simultaneously to enter SETUP mode. The DISP/QUIT key (29) cancels this mode. See page 46 for details.

32) MARK/SET key

This key is used to store an absolute time and time code location in memory.

If you press this key during EDIT mode, the current value will be set.

33) LOC M key and LED

This key will locate to an absolute time or time code location stored in memory. You can also edit the P-NO and located to the edited P-NO. The LED illuminates during the locate operation. See page 43 for details.

This key is not effective in RECORD mode

34) BATT/TAPE key

This key switches between the battery voltage level and the tape remaining indication on the LCD. Each time you press it, the indication changes. By default, the battery voltage level indication is displayed when the PD-4 powers up.

35) LIGHT key

When this key is pressed, the LCD illuminating light will light. it will remain illuminated for approximately two seconds after the key is released. If you press and hold the key for about three seconds, the light will remain illuminated until the key is pressed again.

Fostex PD-4 DIGITAL AUDIO RECORDER

Power and other controls

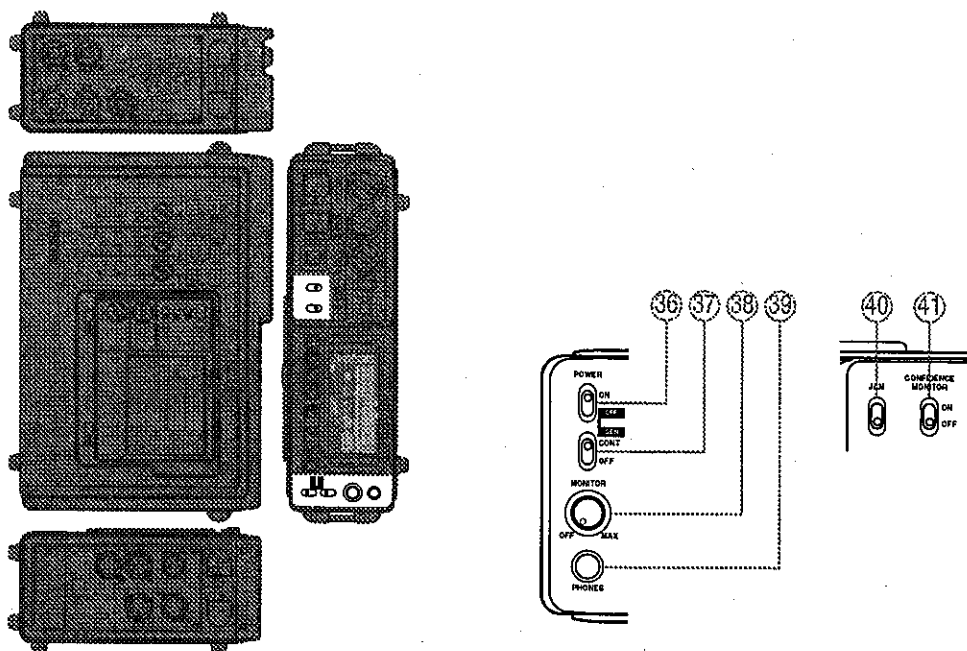

Figure 6
Power and other controls

36) POWER switch

This is the main power switch. Power is immediately shut off by flipping this switch to OFF. The switch is recessed to prevent it from being switched accidentally.

37) GEN switch

This switch will continue to supply power to the ECU and CPU even when the main power is switched OFF. The internal time code will run at crystal precision. The battery (NP-1B) will last for approximately 8 hours in this mode.

Precaution: After you have used the internal battery (NP-1B) for more than eight hours in TC GEN CONT mode, the PD-4 may not power on when you turn the POWER switch (36) OFF and then ON again. In this case, the battery may have been used up. After replacing the battery, turn OFF the GEN switch, turn OFF the POWER switch, then wait a few seconds and turn the power ON again.

38) MONITOR control

This rotary control adjusts the level of the monitor signal. This control is a push-lock type. Once you have set a desired level, push the control in to prevent accidental adjustment.

The signal is heard through the built-in loudspeaker (42) or a set of stereo headphones connected to the PHONES jack (39). To turn off the monitor, rotate the control counter-clockwise until it clicks OFF.

Fostex PD-4 DIGITAL AUDIO RECORDER

39) PHONES jack

This 6mm (1/4") diameter stereo jack is for connecting a pair of stereo headphones to listen to the monitor signal. When a plug is inserted in the jack, the built-in loudspeaker (42) is automatically muted.

40) JAM switch

This switch will cause the internal time code to synchronize with an external source. See page 40 for details.

41) CONFIDENCE MONITOR switch

This switch allows you to monitor the recorded signal directly from the tape using the PD-4's second set of recording heads. The signal is output to the monitor PHONES (39) or built-in speaker (42). Select ON for confidence monitoring or OFF for input monitoring.

This function allows you to check that the signal is being recorded correctly to tape. See page 34 for details.

Input connectors

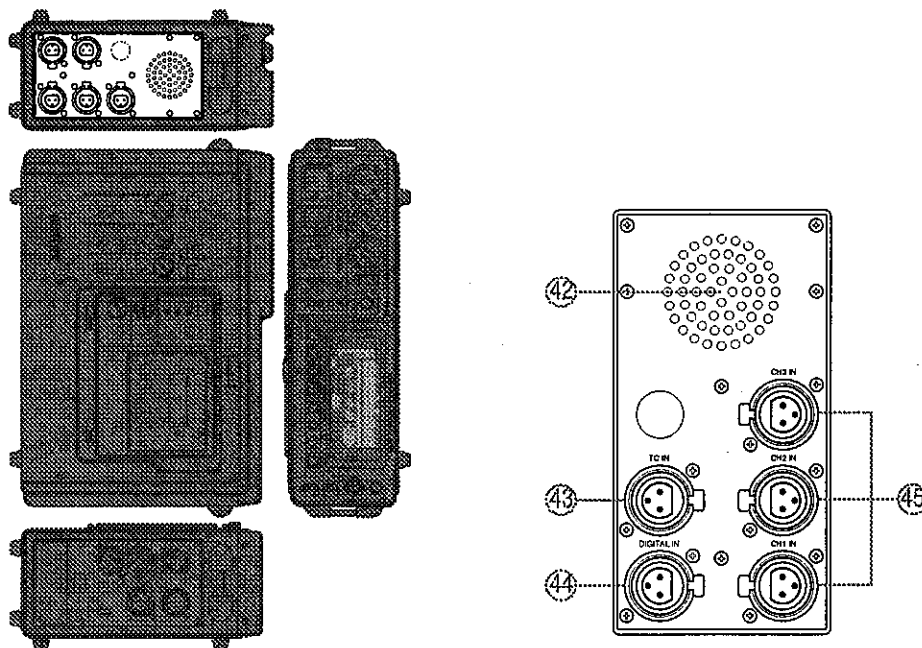

Figure 7
Input connectors

42) Built-in loudspeaker

This speaker is used to listen to the monitor signal.

43) TC (Time Code) IN connector

Balanced external time code input XLR 3-31 type connector.

Fostex PD-4 DIGITAL AUDIO RECORDER

- 44) **DIGITAL IN connector**
Balanced digital input XLR 3-31 type connector for IEC 958 Part 3 (AES/EBU professional) and IEC 958 Part 2 (S/PDIF consumer) formats.
- 45) **Analog input connectors (CH1 IN, CH2 IN, CH3 IN)**
Balanced analog input XLR 3-31 type connectors.

Output connectors

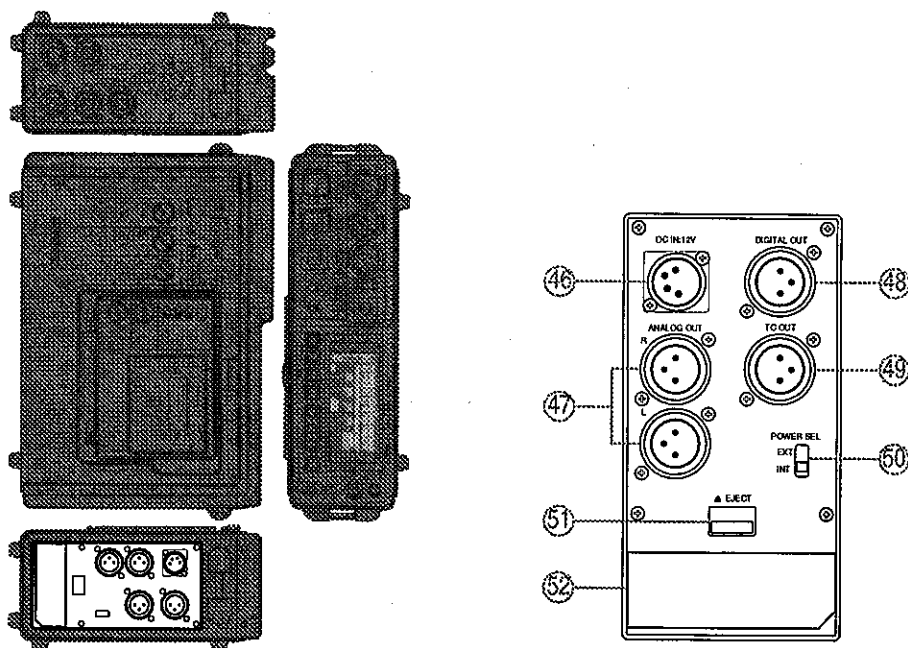

Figure 8
Output connectors

- 46) **DC IN:12V connector**
This 4-pin Cannon-type receptacle is for connecting the external power supply. (AD-15 AC adaptor.)
- 47) **ANALOG OUT (L and R) connectors**
Balanced analog output XLR 3-32 type connectors. (+4 dBu output)
- 48) **DIGITAL OUT connector**
Balanced digital output XLR 3-32 type connector for IEC 958 Part 3 (AES/EBU professional) and IEC 958 Part 2 (S/PDIF consumer) formats.
- 49) **TC (Time Code) OUT connector**
Balanced time code output XLR 3-32 type connector.

Fostex PD-4 DIGITAL AUDIO RECORDER

50) POWER SEL. switch

This switch is used to select between the internal battery (NP-1B) and the external power supply. Select between EXT (external power supply) and INT (internal battery). See page 22 for details.

51) Battery EJECT lever

Press this lever to eject the internal battery (NP-1B).

52) Battery compartment

LCD panel

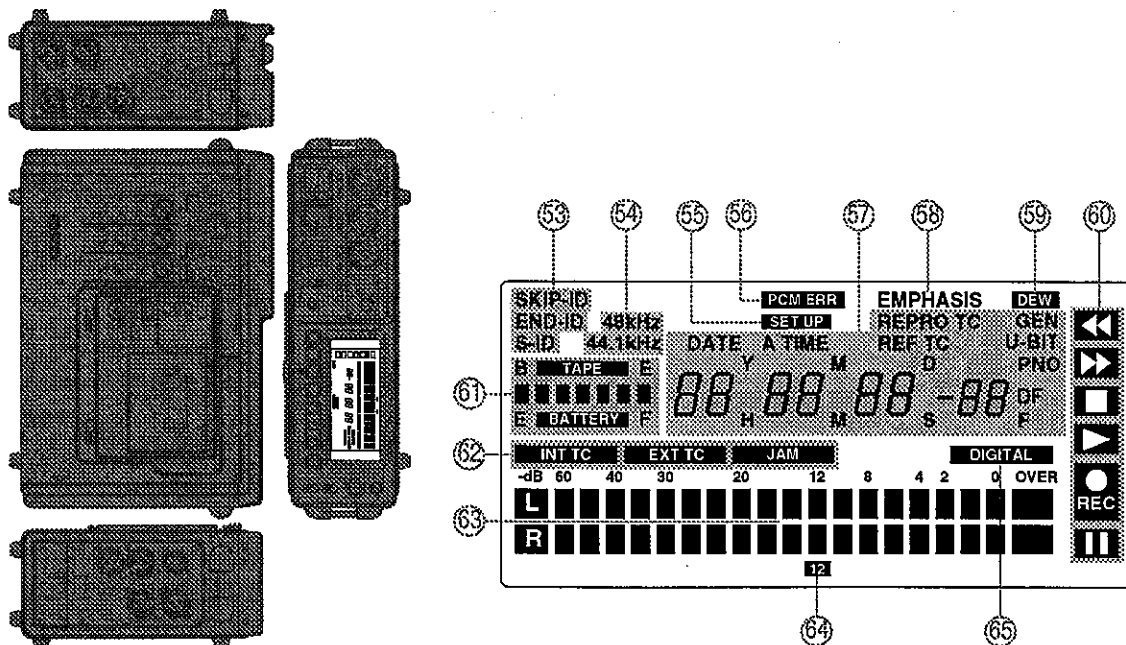

Figure 9
LCD panel

53) ID (SKIP-ID, END-ID, and S-ID) indicators

When the PD-4 reads one of these symbols on the tape, the corresponding indicator will be illuminated. These symbols last 300 ± 30 frames (about 9 seconds) except for SKIP-ID which is 33 ± 3 frames (about one second).

Only the S-ID (start id) can be recorded. Press the S-ID key (16) during record mode. The indicator will flash slowly while the symbol is recorded.

54) Sample rate (48kHz and 44.1 kHz) indicators

The current sample rate is illuminated. If the sample rate is 48.048 kHz, the 48kHz indicator will flash slowly.

Fostex PD-4 DIGITAL AUDIO RECORDER

55) SET UP indicator

This indicator is illuminated when the PD-4 is in SETUP mode.

56) PCM ERR indicator

This indicator is illuminated when a PCM error (with an average BER over 8 frames exceeding 10%) occurs during playback. It will remain illuminated for about 8 frames (240ms) on a momentary error and will remain illuminated during a continuous error.

The PCM ERR LED (23) will also be illuminated red for this error.

57) 7-segment display

The numeric display and supporting indicators are used to show date and time or time code information.

A-TIME display

A TIME PNO

00_H 00_M 24_S 01

When the P-NO is three digits, the display shows the hundreds digit for 0.5 seconds and the other two digits for 1.0 seconds:

PNO PNO

3- 21

The P-NO indicator will flash when the S-ID search or P-NO locate operation has completed.

DATE display

DATE

95^Y 05^M 19^D n̄o

The day-of-the-week also appears:

n̄o	Monday	Tu	Tuesday	WE	Wednesday
7H	Thursday	Fr	Friday	SA	Saturday
Su	Sunday				

Press the ▲ (Up) or ▼ (Down) key (31) to select the second part of the DATE display:

DATE

11_H 57_M 13_S

See page 44 for details of how to edit the Date and Time Code settings.

Time code display

"REF TC" indicates the value of the external time code.

REPRO TC

00_H 00_M 00_S 25_F

The DF indicator will be illuminated for Drop Frame time code:

REPRO TC

U-BIT

00_H 00_M 00_S 29_{DF}

Error display

REPRO TC

Er r o r

58) EMPHASIS indicator

When you playback a tape that has been recorded with EMPHASIS, this indicator illuminated. It will flash rapidly if there is a mismatch between the DIGITAL IN and tape data.

59) DEW indicator

This indicator will flash rapidly when the dew sensor in the transport chassis is on. See the caution on page 4.

60) Operating mode status indicators

These indicators show the current status of the transport.



The REWIND indicator. This indicator is illuminated in fast rewind mode. It is illuminated along with the PLAY indicator in slow rewind mode.



The FAST FORWARD indicator. This indicator is illuminated in fast forward mode. It is illuminated along with the PLAY indicator in slow forward mode.



The STOP indicator. This indicator is illuminated in STOP mode. It flashes when the PD-4 is unloading a tape.



The PLAY indicator.



The RECORD indicator.



The PAUSE indicator.

Fostex PD-4 DIGITAL AUDIO RECORDER

61) BATTERY voltage and TAPE remain indicators.

Each block of the battery indicator is about 1V in a scale of 9.5V to 16.5V. This indicator is shown by default.

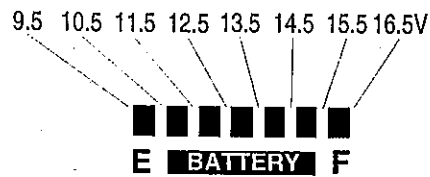

With a 120 minute tape loaded, each block of the tape remain indicator is about 17.5 minutes. To display this indicator, press the BATT/TAPE key (34).

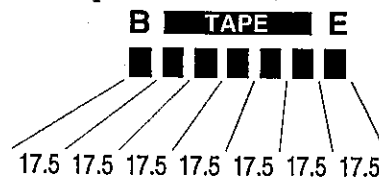

62) Time code (INT TC, EXT TC, and JAM) indicators

The INT TC indicator is illuminated when the time code source is the internal generator.

The EXT TC indicator is illuminated when an external time code signal is present at the TC IN connector. The indicator will flash if you selected EXT RUN with the TC GEN MODE selector switch (6) and no time code is detected at the TC IN connector.

The JAM indicator is momentarily illuminated when the PD-4 is synchronized to external time code.

63) Level meter

These pair of 18 segment level meters show the signal levels being input in record mode or the levels being output in playback mode. The meters are peak hold type. Peak signals are held for approximately 0.5 seconds.

The OVER segment illuminates when the signal level is too high to encode to digital correctly. Distortion results if this indicator illuminates.

64) Reference level (12dB) indicator

65) DIGITAL indicator

This indicator illuminates when the INPUT switch (3) is set to DIGI (digital) and a digital signal is present at the DIGITAL IN connector. The indicator flashes if a digital signal is not detected at the DIGITAL IN connector.

Initial procedures

Using the external power supply

The AD-15 AC adaptor is an optional external power supply for the PD-4. This adaptor should be used when the unit is to be powered from the AC mains. The AD-15 is an Auto-voltage type adaptor. It functions in a voltage range of 100V to 240V (50 Hz or 60 Hz) and can be connected to most AC mains outlets without modification.

Connection to the PD-4 is made via a 4-pin XLR-4-32 type receptacle (see Figure 14 on page 28).

Note: *Make certain the PD-4's POWER switch (36) is in the OFF position before connecting or disconnecting the AD-15 AC adaptor.*

To use the external power supply, the POWER SEL. switch (50) must be set to EXT.

Power supply procedures for time code

If you want to change the external power supply (AD-15 AC adaptor or an external battery) without disrupting the time code generator, follow the procedure below:

- 1) Install the internal battery (NP-1B) into the PD-4.

Note: *Make certain that you are using a fully charged battery.*

- 2) Change the POWER SEL. switch setting from EXT to INT.
- 3) Unplug the power cord of the optional AD-15 AC adaptor and plug it into a different AC outlet, or replace the external battery.
- 4) Change the POWER SEL. switch setting from INT back to EXT.

Using the internal battery

The PD-4 can operate for more than 2 hours with the internal battery (NP-1B).

To install the battery, insert it into the battery compartment with the terminal side first. Press in firmly until the battery EJECT level (51) clicks into place and the battery is locked.

Note: *Make certain that you are inserting the battery with the terminal side first. DO NOT FORCE the battery into the battery compartment.*

To remove the battery, pull the battery EJECT lever upwards until it releases. The battery will pop up.

To use the internal battery, the POWER SEL. switch must be set to INT.

Fostex PD-4 DIGITAL AUDIO RECORDER

Battery check

You can monitor the battery level with the LCD panel.

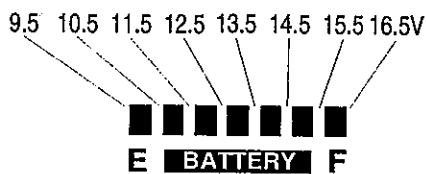

Figure 10
Battery level indicator

The individual segments of battery level display indicate a change in level of about 1V.

By default, the battery voltage indicator is displayed. If it is not displayed, press BATT/TAPE key (34).

When the battery level is about 13V, the display will be as follows:



When the battery level drops below 10.5V, the transport will shut down. The battery indicator will flash on the display as follows:



Note: The indicator will also flash when the battery level is above 16V.

If the battery level drops below 9.5V, the PD-4 will shut down completely. This is to protect the circuits from possible damage. To turn the power on again, first turn OFF the GEN switch and the POWER switch, wait for about ten seconds, and then turn the POWER switch ON.

Reducing battery consumption

To reduce the drain on the PD-4's battery, try some of the following suggestions:

- 1) Do not leave the PD-4 in PAUSE mode for long periods of time. In this mode, the drum motor is running - rotating the record/playback heads.
- 2) Only use the LCD light when necessary.
- 3) Keep headphone or monitor speaker levels to a usable minimum.
- 4) Whenever possible, connect the PD-4's outputs to input loads higher than 10k Ω . 600 Ω input loads tend to drain the battery faster.
- 5) Use of phantom powered microphones will put a greater load on the battery.

Fostex PD-4 DIGITAL AUDIO RECORDER

Powering up the PD-4

Using the internal battery or with the AD-15 external power supply connected to the AC mains and the PD-4, flip the POWER switch to ON.

If there is a DAT cassette in the tape compartment, it will be loaded automatically (LOAD mode), then STOP mode will be engaged. The hard brake (reel lock) is applied in this mode.

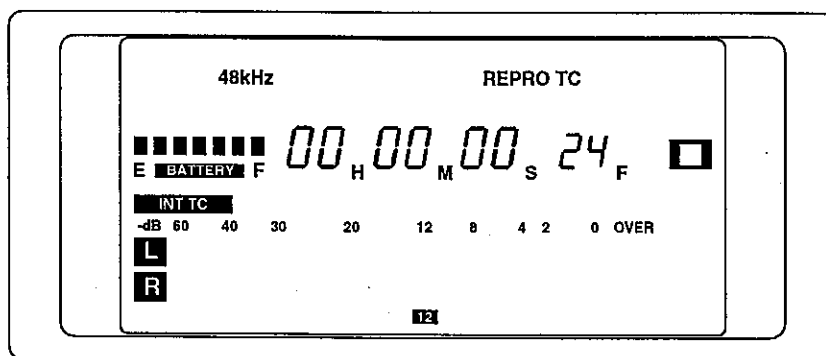

Figure 11
Initial display

Note: The PD-4 is equipped with a dew sensor (see the caution on page 4). If the dew sensor engages, the PD-4 will still power up, but most of the tape transport modes will not operate. The UNLOAD and EJECT operations will still be available.

To turn the PD-4 off, flip the POWER switch to OFF. Shut down will be immediate.

Important notes about using DAT cassettes

Use quality DAT cassettes only in the PD-4. Maxell "DM" or equivalent tapes are recommended.

Do not store DAT cassettes near strong magnetic fields such as near loudspeakers, video monitors, TVs, transformers, etc.

Do not expose DAT cassettes to extremes of temperature or humidity. Do not store tapes in a dusty or dirty environment.

Do not open the cassette's locking lid. If dust, dirt, or impurities (such as oils from the skin) get on the tape surface, dropouts and/or possible damage to the PD-4's record/playback heads and other mechanisms may occur.

Never switch the PD-4 off while the tape transport is active. It is advisable to unload and eject the cassette before you switch off the power.

If a cassette has been stored in a cold location (such as overnight in a car) and is to be used in a warmer environment, you should allow about an hour for the cassette to acclimatize before using it. Failure to observe this precaution may result in malfunction and/or damage to the PD-4.

Fostex PD-4 DIGITAL AUDIO RECORDER

Inserting a DAT cassette

Open the protective cover by sliding the cover-open lever (1) to the right.

Press the EJECT/UNLOAD key (2) to raise the cassette carrier.

Insert the cassette, face up, into the cassette carrier. Push the cassette into the carrier until it clicks into place. Push the carrier down until it clicks into place. Close the protective cover. If the power is on, the PD-4 will automatically load the cassette (LOAD mode), then STOP mode will be engaged.

Ejecting a DAT cassette

Open the protective cover by sliding the cover-open lever to the right.

Press the EJECT/UNLOAD key to raise the cassette carrier. You may have to press this key twice; the first time will unload the cassette (UNLOAD mode).

Remove the cassette from the carrier. Push the carrier down until it clicks into place. Close the protective cover.

To prevent dust and dirt from entering the tape transport section, do not leave the cassette carrier and protective cover open any longer than necessary.

Accidental erasure protection

On the back edge of a DAT cassette is a write protect tab. This is useful for protecting recordings from accidental erasure.

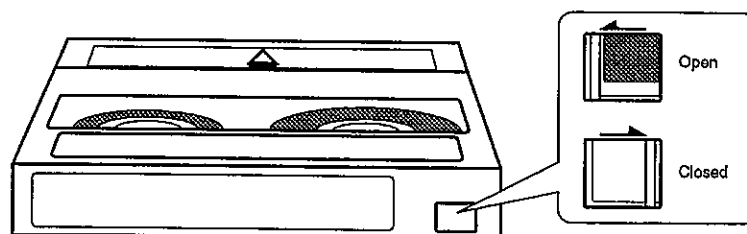

Figure 12
DAT cassette erasure tab

With the tab closed, recording is possible.

With the tab opened, recording is not possible.

Input connections

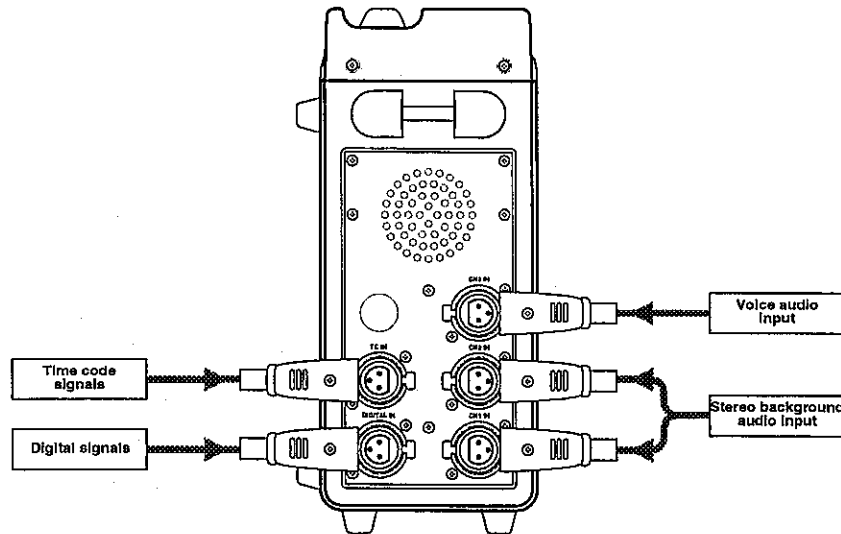

Figure 13
Input connections

Analog input connections

The PD-4 is equipped with three input connectors plus a three channel mixer to allow you to record voice plus a stereo background without requiring the use of an external mixer. This is intended to reduce the amount of equipment you need to carry for location recording, etc.

The analog input connectors (45), CH1 IN, CH2 IN, and CH3 IN, are balanced XLR 3-31 type. Set the INPUT switch (3) to ANA (analog). Select LINE or MIC (microphone) with the LINE/MIC switch (19) for each input channel.

If the LINE/MIC switch for all channels is set to LINE, the microphone preamplifier and limiter circuits are powered off to reduce battery consumption.

Digital input connections

The digital input connector (44), DIGITAL IN, is a balanced XLR 3-31 type. It accepts PCM audio data conforming to the IEC 958 Part 2 (S/PDIF consumer) and IEC 958 Part 3 (AES/EBU professional) data formats.



After you have connected a digital source to the DIGITAL IN connector, set the INPUT switch to DIGI (digital). The PLL (phase-locked lock) is switched on and locked to the input sync signal. Then the sampling frequency is read from the input. The input sample frequency has priority over the setting of the FS(kHz) switch (4). If the input sample frequency and the switch setting disagree, the sample frequency of the switch will be lit while the input will be flashing rapidly on the LCD.

Note: If the input CHANNEL STATUS is 48 kHz and the FS(kHz) switch is set to 48.048, the "48kHz" indicator will flash slowly.

Note: Digital data is only effective in STOP, PAUSE, UNLOAD, and REC modes. You can change the setting of the INPUT switch in STOP, PAUSE, and UNLOAD modes. To record digital data, connect the digital input source, then press the REC key. During recording, make certain that the digital input will not be interrupted.

Fostex PD-4 DIGITAL AUDIO RECORDER

If the PD-4 encounters an error in the digital input signal, the DIGITAL indicator (65) will flash rapidly on the LCD. Otherwise the DIGITAL indicator will be illuminated. Refer to the following table:

Indicator	Meaning
	The INPUT toggle switch is set to DIGI (digital) and correct digital signals are being input.
	The INPUT toggle switch is set to DIGI (digital) but correct digital signals are not being input. This can be caused by the wrong sampling frequency.
	The INPUT toggle switch is set to ANA(analog).

Time code input connection

The time code input connector (43), TC IN, is a balanced XLR 3-31 type. It accepts SMPTE/EBU time code signals.

When a valid external time code signal is received at the TC IN connector, the EXT TC indicator (62) will be illuminated on the LCD.

A valid time code must meet the following requirements:

- 1) It must be continuous in the positive direction.
- 2) The SYNC WORD cycle and the FRAME DATA must coincide.
- 3) There must be no dropouts in the time code signal.

If the TC GEN MODE switch (6) is set to EXT RUN and valid time code is not being received, the EXT TC indicator will flash slowly.

See page 37 for detail.

Note: *If the time code contains a large amount of jitter, it may be difficult to achieve synchronization. This is especially true with LTC (longitudinal time code) recorded on analog tape machines. Therefore, the use of this type of time code as the sync source is not recommended.*

Output connections

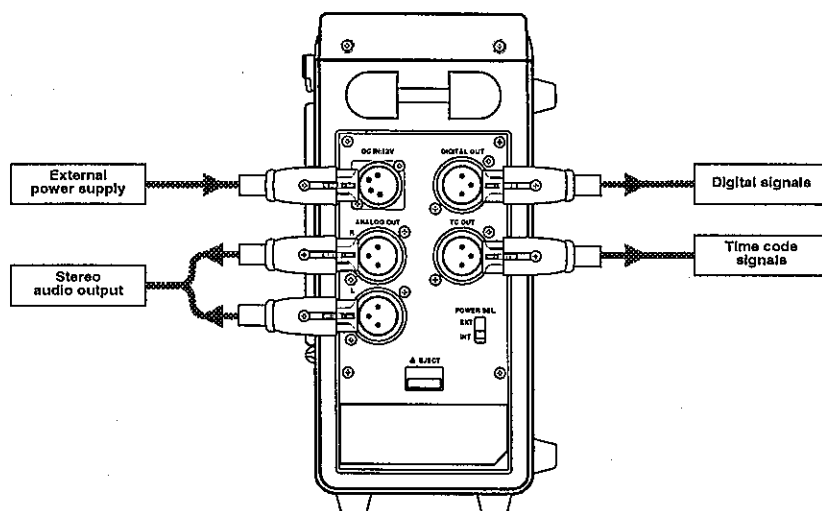

Figure 14
Output connections

Analog output connections

The analog output connectors (47), ANALOG OUT R, and L, are balanced XLR 3-32 type. A +4 dB output signal corresponds to -12 dB on the LCD bargraph level meters.

The tape is the source for the signal output from the ANALOG OUT connectors during PLAY or CUE, and the input is the source during other operations.

To connect these outputs to equipment with unbalanced inputs, use only the GND and HOT pins. Do not connect the unused COLD pin to the GND pin, as this will increase crosstalk and noise. The output level will be 6 dB less than for balanced operation, but performance will be the same.

Note: To reduce battery drain, do not connect the unused COLD pin to ground. Leave it unconnected.

Digital output connection

The digital output connector (48), DIGITAL OUT, is a balanced XLR 3-32 type. It is used to output PCM audio data conforming to the IEC 958 Part 2 (S/PDIF consumer) and IEC 958 Part 3 (AES/EBU professional) data formats.

The output format is automatically selected, dependent on the SETUP mode function 105. See page 47 for details.

Time code output connection

The time code output connector (49), TC OUT, is a balanced XLR 3-32 type. It transmits SMPTE/EBU time code signals.

Fostex PD-4 DIGITAL AUDIO RECORDER

Tape transport controls

STOP



STOP



The STOP key (15) has two modes of operation:

- 1) When the PD-4 is powered up, full stop (STOP mode) is engaged. The STOP key LED is illuminated as is the STOP indicator on the LCD (See Figure 11 on page 24). The tape is loaded, but the pinch roller is not pressed to the capstan and drum cylinder is not rotating.
- 2) Pressing the STOP key will put the PD-4 into pause (PAUSE mode). The PAUSE key LED (17) will illuminate as will the PAUSE indicator on the LCD. In pause mode, the drum cylinder will rotate at normal play speed and the tape will be in contact with the drum. This reduces the play and record start-up times.

Repeatedly pressing the STOP key allows you to toggle between the PAUSE and STOP modes. The PD-4 will automatically switch to STOP mode if it has been in PAUSE mode for over three minutes.

Note: To prevent premature tape and/or drum wear, and to reduce the drain on the battery, use the PAUSE mode only when necessary.

REWIND and F FWD



REWIND



The REWIND (12) and F FWD (13) keys have two modes of operation:

- 1) Pressing the key once will start the slow rewind/forward (CUE) mode. The following conditions will apply,

The pinch roller is pressed against the capstan.

The capstan rotates at five times (5×) play speed.

The drum cylinder rotates at the normal play speed.

In slow rewind mode, the REWIND and PLAY (14) LEDs are illuminated as are the REWIND and PLAY indicators on the LCD. In slow forward mode, the F FWD and PLAY LEDs are illuminated as are the F FWD and PLAY indicators on the LCD. You can monitor the tape in this mode.

- 2) Pressing the key a second time will start the fast rewind/forward mode. The following conditions will apply,

The transport moves the tape at one hundred times (100×) play speed.

The pinch roller is released from the capstan.

The drum cylinder continues to rotate, allowing the PD-4 to pick up subcode information.

In fast rewind mode, the REWIND LED is illuminated as is the REWIND indicator on the LCD. In fast forward mode, the F FWD LED is illuminated as is the F FWD indicator on the LCD.

Repeatedly pressing the REWIND or F FWD keys allows you to toggle between the slow and fast rewind/forward modes.

Fostex PD-4 DIGITAL AUDIO RECORDER

PLAY



PLAY

Press the PLAY key (14) to start playback (PLAY) mode.



The ANALOG OUT (L and R) (47) and the DIGITAL OUT (48) connections are automatically switched from input monitoring to off-tape monitoring.

The playback mode start up time depends on the current mode:

MODE	TIME
PAUSE → PLAY	Less than 0.6 seconds
STOP → PLAY	Less than 1.2 seconds

If a blank tape section is played back, the PD-4 indicates it with the "BLANK" message.

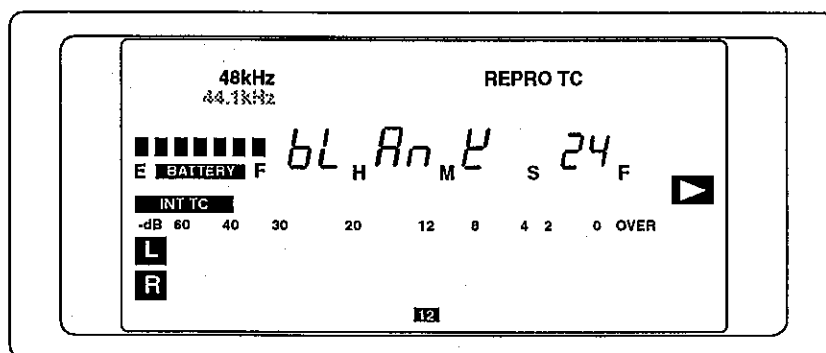

Figure 15
Blank tape indication

REC

The PD-4 is equipped with a single-actuation record switch.

Slide the REC key (18) sideways to start recording (RECORD mode). The red REC LED illuminates as does the REC indicator on the LCD.

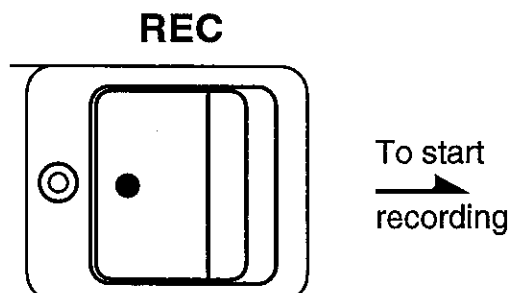

Figure 16
REC key

Note: If the write protect tab on the back of the DAT cassette is opened, the REC key will not function.

PAUSE

Only the PAUSE key (17) is effective during recording. When this key is pressed, the PD-4 will pause, the PAUSE LED will illuminate as will the PAUSE indicator on the LCD.

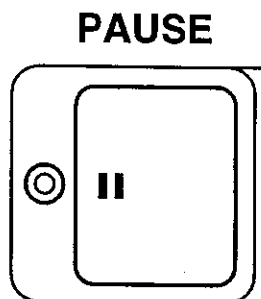

Figure 17
Pause key and LED

Once pause mode is effective, you can select other functions. To resume recording, slide the REC key sideways again.

In pause mode, the drum cylinder will rotate at normal play speed and the tape will be in contact with the drum. The PD-4 will automatically switch to STOP mode if it has been in PAUSE mode for over three minutes.

Recording

Setting the sample frequency

The sample frequency can only be set for analog recording. Use the Fs(kHz) switch (4) on the top panel. The three options are 44.1 kHz, 48 kHz, and 48.048 kHz (which is used for film to Digital VTR conversion).

The current sample frequency will be shown on the display. If the sample frequency is 48.048 kHz, it is shown by the 48 kHz flashing slowly.

If there is a mismatch between the signal input to the DIGITAL IN connector and the sample rate on the tape or the setting of the Fs(kHz) switch, the indicator for the DIGITAL IN sample frequency will flash rapidly and the indicator for the tape or Fs(kHz) switch sample frequency will be illuminated.

When you use the analog input connectors (CH1 IN, CH2 IN, and CH3 IN) (45), if there is a mismatch between the sample rate on the tape and the setting of the Fs(kHz) switch, the indicator for the tape sample frequency will flash rapidly and the indicator for the Fs(kHz) switch sample frequency will be illuminated. However, in STOP and UNLOAD modes, only the indicator for the Fs(kHz) switch sample frequency will be illuminated.

In either digital or analog input modes, the flashing sample rate is the effective sample rate.

Note: The sample frequency cannot be change while recording is in progress. If a different sample frequency is selected while recording is in progress, it will only become effective when the recording stops.

Using the 48.048 kHz setting:

This setting is useful when you transfer images from film into digital VTR data (such as D-2 SONY), and make it into the NTSC data.

When the Fs(kHz) switch is set to 48.048kHz, the time code frequency will be raised by 0.1%. If you set the FRAME RATE selector switch (7) to 29.97DF, the time code will be recorded using the 29.97DF format on the tape, but the output from the TC OUT connector will be 30DF.

Settings: PD-4: FS(kHz): 48.048 kHz Film: Frame Rate: 30DF
FRAME RATE: 29.97DF
TC GEN MODE: FREE RUN

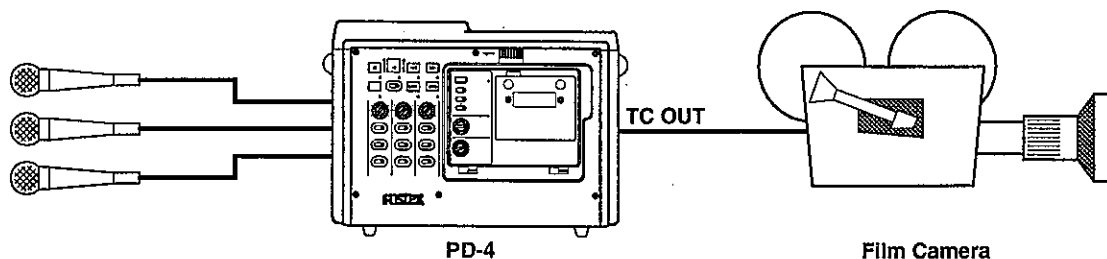

Figure 18
When shooting

A time code of 30DF will be recorded on the film. In this application, the film time code is assumed to be 30 frames/sec.

Fostex PD-4 DIGITAL AUDIO RECORDER

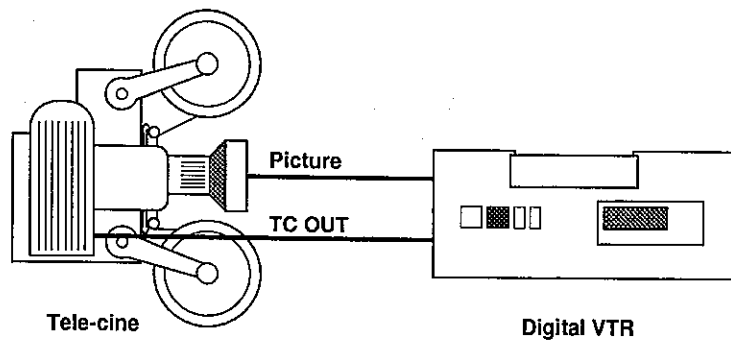

Figure 19
Conversion

In this case, a pitch deviation of -0.1% is applied to the data from the film. Therefore, a time code of 29.97DF will be recorded on the DIGITAL VTR.

Settings:	Slave:	FS(kHz):	48 kHz	Master (Digital VTR):	FS(kHz):	48 kHz
		FRAME RATE:	29.97DF		FRAME RATE:	29.97DF

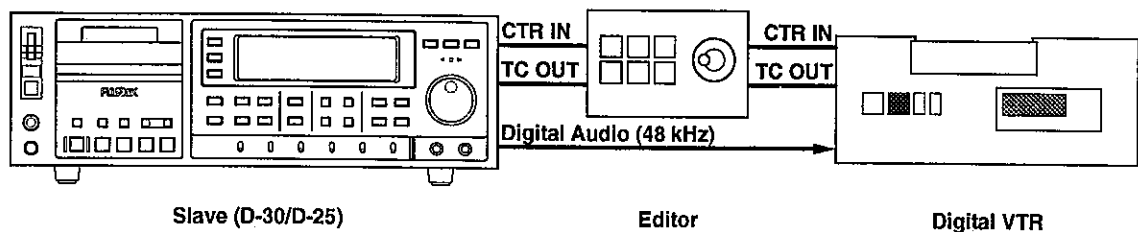

Figure 20
Editing

By synchronizing the time code, a pitch deviation of -0.1% is applied to the AUDIO data. In this way, the audio data will synchronize with the image.

Microphone input settings

Note: In order for the following functions to be used, the INPUT switch (3) must be set to the ANA (analog) setting. To conserve battery power, the PD-4 does not provide power to the microphone preamplifier and limiter circuits.

LINE/MIC switch

When the LINE/MIC switch (19) is switched to the MIC (microphone) setting, the microphone preamplifier and limiter circuits are powered up. When this switch is in the LINE setting, only the analog-to-digital convertor section is powered up.

Each input channel can be switched independently.

Note: To reduce the possibility of noise, set the LINE/MIC switch of channels you are not using to the LINE setting.

Attenuation

To prevent the microphone amplifier from clipping, 20 dB of gain attenuation can be applied to the input signal. Use the ATT(dB) switch (20) to select 0 (no attenuation) or 20 (20 dB of attenuation). If the PEAK LED (25) for a channel is constantly illuminating, you should attenuate the input.

This function is only available when the LINE/MIC switch is set to MIC. Each input channel can be switched independently.

Phantom power

The PD-4 can provide power to condenser-type microphones. Set the PHANTOM switch (21) to the P48 setting to send 48V DC through the analog input connectors (CH1 IN, CH2 IN, and CH3 IN) to the microphone.

This function is only available when the LINE/MIC switch is set to MIC. Each input channel can be switched independently.

Filter

The FILTER(Hz) control (22) is a continuously variable rotary control. It is only active when the LINE/MIC switch is on the MIC setting. The cut-off frequency of the filter can be set from 20 to 300 Hz. It is a high-pass filter with a slope of -12 dB/octave.

This function is useful when you want to remove wind noise and rumble when recording outdoors, or when you want to remove undesirable low-frequency noise while recording voice or music indoors or outdoors.

Each input channel can be filtered independently.

Limiter

The limiter allows a more consistent signal level to be achieved when recording with microphones. The limiter is applied to the input signal after the three input channels are mixed to two channels. It affects both the right and left channels.

The limiter circuit is powered on with the LIMITER switch (24). The INPUT switch must be set to ANA (analog) and the LINE/MIC switch to MIC (microphone).

The limiter is a VCA (voltage controlled amplifier) circuit with the threshold set at -12 dB from 16-bit full scale level (all bits on). A compression ratio of 1:3 is applied to signal levels above the threshold. The limiter attack time is 20ms and the release time is 200ms.

Record monitoring

Stereo headphones / internal speaker

Plug a set of stereo headphones into the PHONES jack (39) This is a standard 6mm (1/4") diameter stereo jack. When you connect a pair of stereo headphones to the jack, monitoring through the headphones is automatically selected.

Fostex PD-4 DIGITAL AUDIO RECORDER

The signal source for the monitor depends on the setting of the CONFIDENCE MONITOR switch (41):

CONFIDENCE MONITOR switch	Mode	Source
OFF	F FWD, REWIND, PAUSE, REC	Input
	PLAY, CUE*	Off tape
ON	F FWD, REWIND, PAUSE	Input
	REC, PLAY, CUE*	Off tape

* Slow rewind/forward mode.

The volume level of the built-in loudspeaker or the stereo headphones is controlled by the MONITOR control (38). This control is a push-lock type. Once you have set a desired level, the control can be recessed to prevent accidental adjustment.

To recess the control, press it in until it clicks into place. To release the control, press it again until it clicks and releases.

To turn off the monitor, rotate the control counter-clockwise until it clicks OFF.

Analog output

The signal source selection for the analog output is shown in the following table:

Mode	Source
F FWD, REWIND, PAUSE, REC	Input
PLAY, CUE*	Off tape

* Slow rewind/forward mode.

The analog output is unaffected by the setting of the MONITOR control.

Digital output

The signal source selection for the digital output is shown in the following table:

Mode	Source
F FWD, REWIND, PAUSE, REC	Input
PLAY, CUE*	Off tape

* Slow rewind/forward mode.

The digital output is unaffected by the setting of the MONITOR control.

Recording audio

Input selection

To record analog audio either from a line source or from microphone, set the INPUT switch to ANA (analog) position. Connect the input source to the individual analog input connectors (CH1 IN, CH2 IN, and CH3 IN). set the corresponding LINE/MIC switch to the correct setting. If you are using a microphone, see "Microphone input settings" on page 33 for other settings you may need to make.

Fostex PD-4 DIGITAL AUDIO RECORDER

Level setting

For each input channel, select the pan position of the input signal with the L C R (panpot) switches (26). Set the channel to L (left), C (centre), or R (right).

Note: Although the PD-4 has a three channel mixer, like all professional DAT recorders, it will record two channels (stereo) of digital audio.

The input signal level of the individual channels is adjusted with the input controls (27) and the overall level is set with the MASTER level control (28).

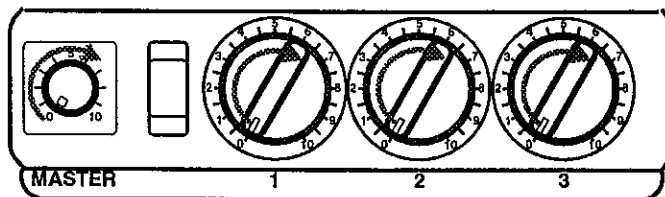

Unlike analog tape recorders, a digital recorder has limited headroom in response to excessive signal levels. Once all 16-bits are used up, the digital system cannot correctly reproduce the input signal. The result is a very harsh distortion.

For this reason it is essential that you set your recording levels with care.

Do not let the signal level exceed 0 dB on the LCD level meters (63). At the same time, to achieve the best signal-to-noise response, try to keep the signal peaks close to 0 dB without exceeding it.

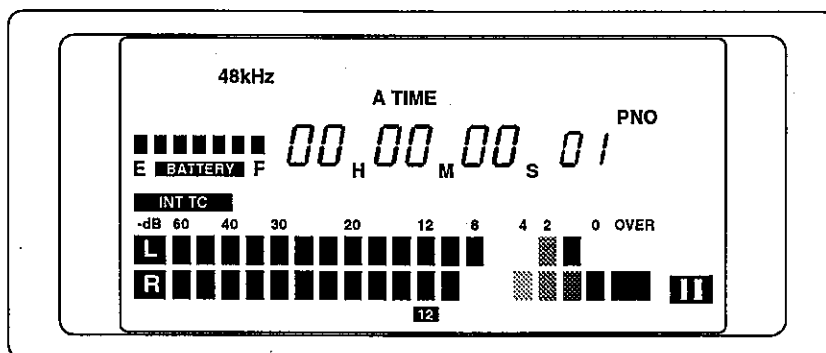

Figure 21
Setting recording levels

In Figure 21, the LCD is displaying an overload condition for the R (right) channel. The input signal is too high. You need to reduce the levels when you see a display similar to this. The L (left) channel indicates a more acceptable level.

When recording outdoors with microphones, it may be difficult to determine the peak signal level. Therefore, you should reduce the recording levels a little to allow for signal peaks. Use the limiter to achieve a more consistent signal level.

The PD-4's level meters hold signal peaks (PEAK HOLD) for 0.5 seconds.

Overload indication

The PEAK LED (25) will illuminate when clipping occurs in the input channel.

Fostex PD-4 DIGITAL AUDIO RECORDER

If the SETUP mode function 110 is on, a 1 kHz pulsating error tone will be heard from the built-in loudspeaker or the stereo headphones.

Note: *If the MONITOR control is switched OFF, the error tone will not be heard.*

Start record mode

When all the required connections, settings, and monitoring options have been set, start recording. Slide the REC key to the right. The REC LED illuminates and the PD-4 begins to record.

Press the PAUSE key to pause the recording. To resume recording, slide the REC key to the right again. To cancel the recording, press PAUSE to pause the PD-4 and then press any other key.

Recording time code

To record time code on the PD-4, you must check the settings of three switches:

- 1) The TC OUT switch (5).
- 2) The TC GEN MODE switch (6).
- 3) The FRAME RATE switch (7).

Time code source

The TC OUT switch selects the source of the time code that is to be output through the TC OUT connector (49). GEN selects the internal clock. REPRO selects the time code specified by the SETUP mode functions 403 and 408 (see page 49).

TC GEN MODE switch settings

EXT RUN

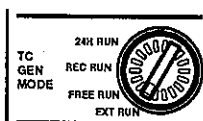

If there is no external time code present when you select EXT RUN, the EXT TC indicator (62) on the LCD flashes slowly. If you start recording in this state, no time code will be recorded.

If there is external time code present, it will be recorded. The EXT TC indicator on the LCD will be illuminated.

FREE RUN

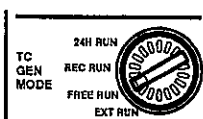

Internal time code is recorded when you select FREE RUN. The year/month/day/time (reel number) of the real time clock is recorded in PRO BINARY format. The INT TC indicator on the LCD will be illuminated.

If external time code is present and you press the JAM switch (40), the PD-4 will synchronize to the external time code. The year/month/day/time of the external time code is copied into the UBIT of the PRO BINARY format. The EXT TC indicator on the LCD will also be illuminated.

The JAM indicator will be momentarily illuminated after the JAM switch is pressed.

Fostex PD-4 DIGITAL AUDIO RECORDER

REC RUN

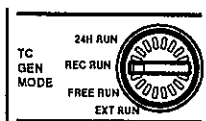

Other than in REC mode, the internal time code is in the PAUSE state. The JAM switch is ineffective, editing is disabled, and the INT TC indicator on the LCD flashes slowly. If the external time code cannot be read, both the JAM key and editing are enabled.

In record mode, internal time code is recorded. Based on the UBIT information in the time code already recorded on the tape, PRO RTIME or PRO BINARY format is recorded while renewing the time code information. The INT TC indicator on the LCD will be illuminated.

When recording, if external time code is present and you press and hold the JAM switch for more than two seconds, the PD-4 will synchronize to the external time code. The year/month/day/time of the external time code is copied into the UBIT of the PRO BINARY format. The EXT TC indicator on the LCD will also be illuminated.

The JAM indicator will be illuminated for a short time after the JAM switch is released. If the JAM switch is not pressed, the time code recorded on the tape has priority.

You can change the internal time code using the edit function.

24H RUN



The real time clock (RTC) time code will be recorded from the internal generator. The year/month/day/time (reel number) is recorded in PRO BINARY format. The INT TC indicator on the LCD will be illuminated.

If external time code is present and you press the JAM switch, the PD-4 will synchronize to the external time code. The EXT TC indicator on the LCD will also be illuminated.

The JAM indicator will be momentarily illuminated after the JAM switch is pressed. JAM data is hours/minutes/seconds/frames - not year/month/day/time (reel number). When the JAM switch is pressed, the hours/minutes/seconds/frames of the DATE data is also updated.

The frame rate will follow the setting of the FRAME RATE switch.

Time code display modes

The display (57) cycles through different modes depending on the setting of the TC GEN MODE switch. Each time you press the DISP/QUIT key (29), the display shows another mode.

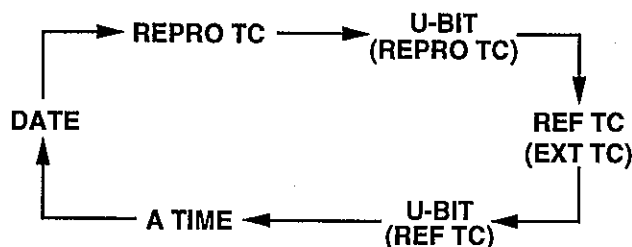

Figure 22
EXT RUN mode

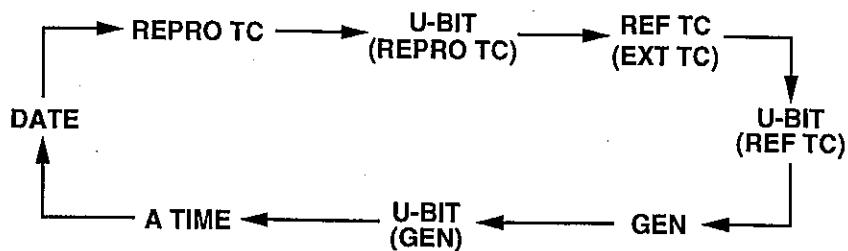

Figure 23
FREE RUN and REC RUN modes

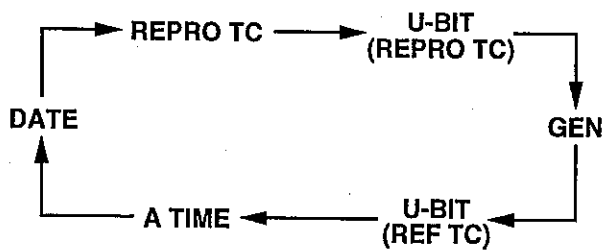

Figure 24
24H RUN mode

Frame rate selection

In record mode, the frame rate selection follows the following priority:

In REC RUN mode, if a time code is already recorded on the tape, the frame rate of the recorded time code is selected.

In EXT RUN mode, if an external time code is connected and a signal present, the frame rate of the external time code is selected.

In FREE RUN/24H RUN modes, the frame rate set by the FRAME RATE switch is selected.

If there is a difference between the selected frame rate and the setting of the FRAME RATE switch, the frame rate indication on the LCD will flash.

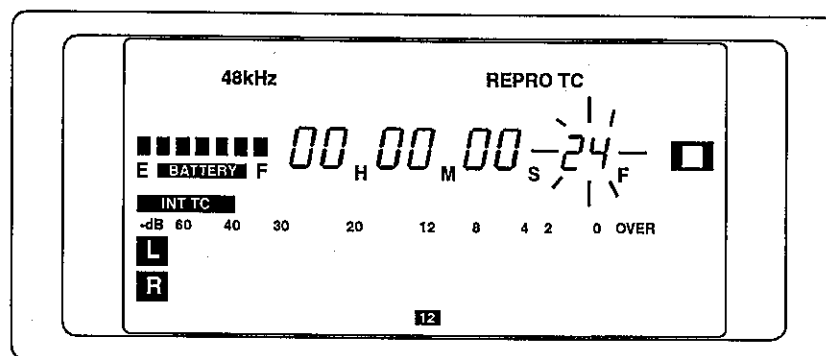

Figure 25
Incorrect frame rate

Note: As the difference between an external time code frame rate of 29.97 and 30 cannot be distinguished, it will be determined by the setting of the FRAME RATE switch.

JAM time code recording

The JAM function allows you to disconnect the external time code source, after time code synchronization has started, and let the internal generator continue striping the tape. The use of a crystal oscillator in the PD-4 ensures there is no timing difference between the internal and external time code.

The JAM function varies depending on the TC GEN MODE switch setting as shown in the following table:

Setting	Notes
24H RUN	Pressing the JAM key will synchronize the PD-4 to the external time code. The frame will follow the FRAME RATE switch setting, and the TCM setting will be fixed to "0."
REC RUN	When you press and hold the JAM switch for ore than two seconds during recording, the PD-4 will synchronize to EXT TC/UBIT if it is receiving external time code. In this case, the value of UBIT at the time of synchronization will be maintained. When the JAM function is on, the JAM indicator will illuminate for a while after you release the JAM key. If the PD-4 does not read any time code, the "JAM" and "EDIT" functions become effective even the unit is not in the REC mode.
FREE RUN	JAM is effective for any existing external time code. The value of the external time code UBIT will be copied and maintained. The JAM indicator will illuminate for a while after you release the JAM key.
EXT RUN	Not effective

To use the JAM function, the following conditions must apply:

- 1) An external time code source must be plugged into the TC IN connector.
- 2) The EXT TC indicator must be illuminated.
- 3) The frame rate of the external time code and the setting of the FRAME RATE switch must be the same.

Start recording with the external time code generator. To switch to internal generation, press and hold the JAM switch (40). When the JAM indicator illuminates on the LCD, release the JAM switch. The internal generator is now in free run mode. The external time code source can be disconnected.

You can switch back to external time code by pressing the JAM switch for two seconds. The external time code source must be reconnected.

S-ID and P-NO recording

To record a S-ID, press the S-ID key (16) while the PD-4 is in RECORD mode. A S-ID (start id) and a P-NO (program number) are usually recorded simultaneously. If the previous P-NO cannot be read, only the S-ID will be recorded.

Fostex PD-4 DIGITAL AUDIO RECORDER

It takes nine seconds to record the S-ID and P-NO. During this time, the S-ID indicator (53) will flash on the display.

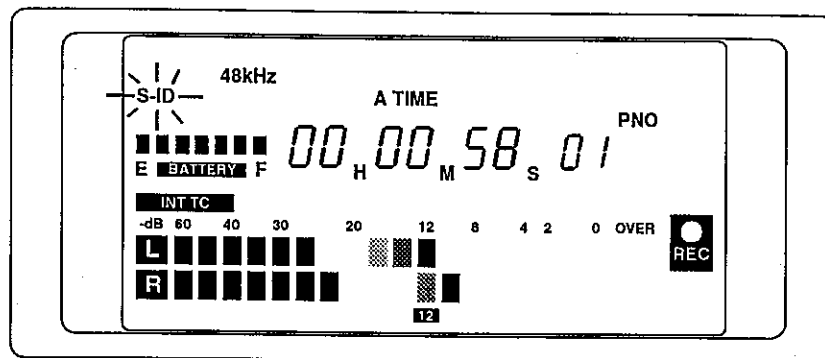

Figure 26
Recording the S-ID and P-NO

P-NO automatic mode

There are two ways to automatically record the S-ID and P-NO:

- 1) To record the S-ID and P-NO at the point when you press the REC key.
- 2) To record the S-ID and P-NO automatically at the point when the sound is detected.

If the SETUP mode 106 is set to On (01), the S-ID and P-NO is automatically recorded each time you press the REC key. If it is set to Auto (02), the S-ID and P-NO is automatically recorded when the signal level exceeds the detection threshold (SETUP mode 201 and 202).

Setting the start P-NO

To set the P-NO value:

- 1) Press the DISP/QUIT key (29) repeatedly to change to the A-TIME display.
- 2) Press the EDIT/▶ key(30) to edit the time display. Press the EDIT/▶ key repeatedly until the P-NO field is flashing on the display.
- 3) Press the ▲ (Up) or ▼ (Down) key (31) to change the current value.
- 4) To cancel edit mode, press the DISP/QUIT key.

The entered P-NO will be written on the tape when you press the S-ID key during recording. If the SETUP mode 106 is set to On (01), the entered P-NO is automatically recorded when you press the REC key.

The normal procedures for recording P-NO data is as follows:

When a new P-NO is recorded, its value will be the current P-NO incremented by one (+1).

Right after BOT is detected, record P-NO "001"

When the P-NO display shows "--", a P-NO will not be recorded.

After editing the P-NO, the edited P-NO value will be recorded.

Playback

Normal playback

Start playback by pressing the PLAY key (14). To pause playback, press either the PAUSE key (17) or the STOP key (15). Pressing either key puts the PD-4 into PAUSE mode. The PAUSE LED will illuminate. In pause mode, the drum cylinder will rotate at normal play speed and the tape will be in contact with the drum.

To engage STOP mode, press the STOP key twice.

Cue playback

CUE mode allows you to monitor the tape during the slow rewind/forward modes.

If you press either the REWIND (12) or F FWD key (13) once, the PD-4 will play the tape at five times (5x) playback speed.

To cancel CUE mode, press the REWIND or F FWD key again to switch to fast rewind/forward mode, or press any other key to select some other operation.

See "REWIND and F FWD" on page 29.

Search functions

Blank search

The blank search function finds the last section of recorded tape, then engages pause mode immediately before it.

If there is an END-ID recorded on the tape, it will be located. Pause mode will be engaged immediately before the END-ID. The END-ID will be erased if recording is started at this point.

The blank search is beneficial for the following reasons:

- 1) If A-TIME has been recorded up to the point found by the blank search, subsequent A-TIME recording will be continuous.
- 2) If a P-NO can be read up to the point found by the blank search, subsequent P-NO recording will be continuous. If it cannot be read, only the S-ID will be recorded.
- 3) If internal time code has been recorded up to the point found by the blank search, subsequent internal time code will be continuous.

In any mode other than REC RUN mode, subsequent internal time code will not be continuous.

Fostex PD-4 DIGITAL AUDIO RECORDER

S-ID search

▶▶ S-ID SEARCH key and LED

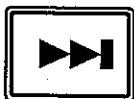

The PD-4 will search for a specified S-ID in the forward direction. You specify the number of S-ID's from the current location by pressing this key that number of times.

The number you specified will be shown as P-NO on the display. As the PD-4 searches for the specified S-ID, the number will countdown to "00". When the specified S-ID is reached, the transport will rewind slightly, mute PLAY up to the S-ID, and then PAUSE at about one second before the S-ID. The searched S-ID/P-NO will momentarily flash, indicating that the position before the S-ID has been located.

◀◀ S-ID SEARCH key and LED



The PD-4 will search for a specified S-ID in the reverse direction. You specify the number of S-ID's from the current location by pressing this key that number of times.

Similar to the previous command, the number you specified will be shown as P-NO on the display. However, the number will be prefaced by the minus ("-") sign. As the PD-4 searches for the specified S-ID, the number will countdown to "00". When the specified S-ID is reached, the transport will rewind slightly, mute PLAY up to the S-ID, and then PAUSE at about one second before the S-ID. The searched S-ID/P-NO will momentarily flash, indicating that the position before the S-ID has been located.

Locate

You can mark a location on the tape in either absolute time or time code by pressing the MARK/SET key (32).

To locate to the stored location, press the LOC M key (33). The time of the marked location will flash slowly on the display for two seconds. The transport will rewind or fast forward to the marked location.

The following conditions apply:

- 1) If the display is showing time code, the locate function will locate to the time code point. If there is no time code on the tape, it will locate to the absolute time location.
- 2) If the display is showing the date or absolute time, the locate function will locate to the absolute time location.

Other functions

Tape remaining

To check the remaining time on the tape, press the BATT/TAPE key (34). The TAPE remaining indicator is illuminated on the display.

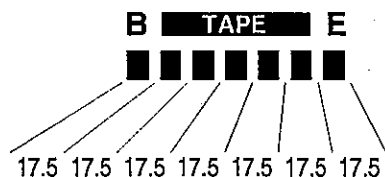

Figure 27
Tape remaining indicator

On a 120 minute DAT cassette, each segment indicates about 17.5 minutes.

Note: You will get a more accurate estimation of tape usage with the A-TIME display. To display an accurate tape remaining estimate, you need to play the tape for approximately 15 seconds.

Editing the date and time code

Use the EDIT / ► key (30) to edit the time display. You can edit the DATE, A-TIME, and all of the time code fields. Editing the time code fields depends on the setting of the TC GEN MODE switch:

- 1) In free run mode, you can edit any of the time code fields.
- 2) In external run and 24-hour run modes, you cannot edit any of the time code fields.
- 3) In rec run mode, you can edit the time code fields in record mode or if a blank tape has been loaded.

Press the key once to enter EDIT mode. To select the next field, press the key again. The current character will flash slowly.

To edit the current character, press the ▲ (Up) or ▼ (Down) key (31). If you hold the key for more than a second, it will auto-increment/decrement the value of the current character.

To cancel edit mode, press the DISP/QUIT key (29).

Setting EDIT TIME

MARK/SET key (32):

Pressing this key during REF TC, REPRO TC, or A-TIME edit will store the current value as the data to locate.

Pressing this key during GEN TC edit will revise the value of the internal time code generator.

Pressing this key during DATE edit will revise the value of the DATE.

Fostex PD-4 DIGITAL AUDIO RECORDER

LOC M key (33)

Pressing this key during REF TC, REPRO TC, or GEN TC edit will locate to the edited time code value.

Pressing this key during A-TIME edit will locate to the edited A-TIME value.

Pressing this key during P-NO edit will locate to the edited P-NO value.

SETUP mode functions

Selecting a SETUP mode function

To enter SETUP mode, simultaneously press both the ▲ (Up) and ▼ (Down) keys (31).

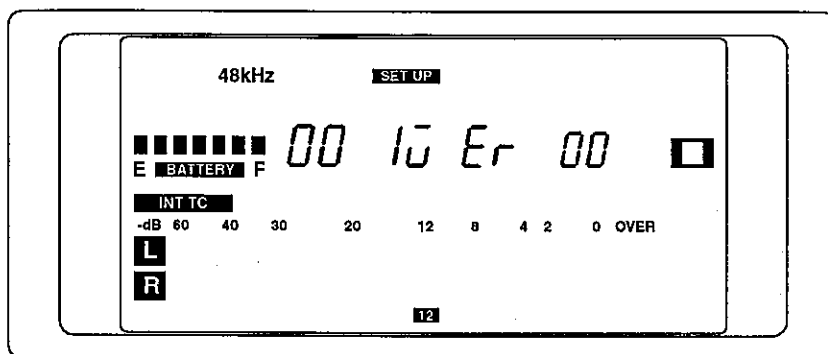
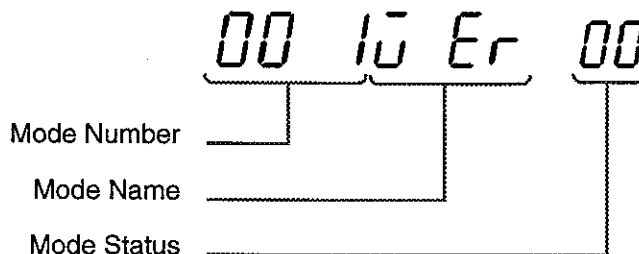

Figure 28
SETUP mode display

To select a SETUP mode function, press the ▲ (Up) or ▼ (Down) keys until the function number you want is shown on the LCD. The PD-4 cycles through the functions, either forward or backward, returning to the starting function.

Editing a SETUP mode function



After selecting a SETUP mode function to edit, press the MARK/SET key (32). The function status will flash slowly. Press the ▲ (Up) or ▼ (Down) keys to change the status value. Some functions have only two possible status values, others have more.

To ignore the status change, press the DISP/QUIT key (29).

To set the new status value, press the MARK/SET key. The new status is set in memory. SETUP mode function 001 is used to verify (check) the status of the PD-4. For SETUP mode function 801, you access the "Memory Reset" function by pressing the MARK/SET key after selecting the mode.

Pressing the DISP/QUIT key again exits from SETUP mode.

Fostex PD-4 DIGITAL AUDIO RECORDER

Function descriptions

The item marked with an asterisk (*) indicates the factory default setting for that parameter.

System functions

(001) Display the ROM version

00 10 Er 00

Display information about the ROM and CPUs.

- | | |
|-----|--|
| 00* | Version display off. |
| 01 | Displays the version of the main CPU. |
| 02 | Displays the date of the main CPU. |
| 03 | Displays the version of the front CPU. |
| 04 | Displays the version of the transport mechanism. |

After you have selected one of the above options and exit from SETUP mode, the version information requested is shown on the display.

For example, if you select option 02 (display the date of the main CPU), you will see a display similar to the following for about three seconds:

19 95 2 28

ID and control functions

(105) Digital output format

10 5d 0F 00

Selects the digital output format.

- | | |
|-----|---|
| 00* | IEC 958 Part 3 (AES/EBU professional) format is output. |
| 01 | IEC 958 Part 2 (S/PDIF consumer) format is output. |

(106) Automatic recording of S-ID/P-NO

10 6A 1d 00

Controls if a S-ID (start identification mark) and P-NO (program number) is recorded during the recording operation. The PD-4 will record a S-ID/P-NO automatically when you press the REC key, or it can detect silence, recording a S-ID/P-NO when a signal is detected.

- | | |
|-----|---|
| 00* | Off - S-ID/P-NO is not recorded automatically. |
| 01 | On - S-ID/P-NO is recorded automatically at the point when you press the REC key. |
| 02 | Auto - S-ID/P-NO is recorded automatically at the point when the PD-4 detects sound. See page 48 for details. |

Fostex PD-4 DIGITAL AUDIO RECORDER

The following conditions apply to S-ID/P-NO recording:

- 1) The P-NO to be recorded is the number currently displayed plus one.
- 2) Immediately after detecting BOT, P-NO "001" will be recorded.
- 3) When "--" is displayed, only S-ID will be recorded, not P-NO.
- 4) When the P-NO is edited, the edited P-NO will be recorded.

(110) Error tone

11 0E 7n 01

Turn the error tone on or off.

00	Off.
01*	On.

The error tone is a 1 kHz pulsating tone that is output to the built-in loudspeaker or stereo headphones to warn of a malfunction. The error tone sounds for the following conditions:

- 1) When the average BER (block or burst error rate) of 8 frames is greater than 10%. The PCM ERR LED (23) is illuminated red.
- 2) When clipping occurs in the input channel amplifier. The PEAK LED is illuminated.
- 3) When the power supply voltage is abnormal - either below 11V or above 16V.

Note: The error tone will not be heard if the MONITOR control is turned OFF.

(111) LCD contrast

11 1L [d 07

Set the contrast for the LCD screen.

00	Minimum contrast level
...	...
07*	Maximum contrast level

Silence detection functions

(SU 201): Silence detection level setting

20 1A 1L 02

If SETUP mode function 106 is set to Auto (02), this function determines the signal level threshold before a S-ID/P-NO is recorded.

00	-20 dB
01	-30 dB
02*	-40 dB

Fostex PD-4 DIGITAL AUDIO RECORDER

03 -55 dB

(SU 202): Silence detection duration setting

20 2A 17 02

If SETUP mode function 106 is set to Auto (02), this function determines the signal duration before a S-ID/P-NO is recorded.

00	300 msec
01	600 msec
02*	900 msec
03	1.2 sec
04	1.5 sec

Time code functions

(401) Time code frame rate

40 17 CF 00

Determines if playback time code is generated automatically from the code recorded on the tape or if it is generated at the setting of the FRAME RATE selector switch (7).

00*	Playback time code at the recorded frame rate.
01	Playback time code at the setting of the FRAME RATE selector switch.

(403) Still time code

40 35 7C 00

Select whether to output time code while the PD-4 is in PAUSE mode.

00*	Time code is not output.
01	Time code will be output.

Note: The TC OUT switch (5) must be set to REPRO.

Note: When the PD-4 is in PAUSE mode, the time code that is output will be stationary (time code that continuously repeats the same time).

(408) Automatic time code

40 87 Co 00

Determines if time code should automatically switch to GEN while the PD-4 is in PAUSE or STOP modes.

00*	Automatically switch to GEN.
-----	------------------------------

Fostex PD-4 DIGITAL AUDIO RECORDER

01 Source remains the tape.

Note: The TC OUT switch must be set to REPRO.

Overall time code output functions

TC OUT switch	SETUP functions		Operation
	Automatic TC [408]	Still TC [403]	
REPRO	Automatic (00)	Off ((00)	GEN time code is output in PAUSE, STOP, UNLOAD, and NOPACK modes.
			GEN time code is output in REC mode.
			Tape time code is output in other modes.
		On (01)	GEN time code is output in STOP, UNLOAD, and NOPACK modes.
			GEN time code is output in REC mode.
			Tape time code is output in other modes.
	Tape (01)	Off (00)	Time code is not output in PAUSE, STOP, UNLOAD, and NOPACK modes.
			GEN time code is output in REC mode.
			Tape time code is output in other modes.
		On (01)	Time code is not output in STOP, UNLOAD, and NOPACK modes.
			GEN time code is output in REC mode.
			Tape time code is output in other modes.
GEN		GEN time code is constantly output.	

Note: In slow rewind/forward (CUE) and fast rewind/forward modes, 5 frames are generated and output.

Note: When the PD-4 is in PAUSE mode, the time code that is output will be stationary (time code that continuously repeats the same time).

User functions

(801) Reset all user memory

80 17 r5 00

Resets locate memory and all SETUP mode functions to their factory defaults.

00 Execute the reset.

In this function, when you press the MARK/SET key, the following message appears on the display:

r5 7 5u rE

Fostex PD-4 DIGITAL AUDIO RECORDER

Press the MARK/SET key again to reset all SETUP mode functions to their factory defaults.

Press the DISP/QUIT key to cancel the reset operation.

SETUP mode functions

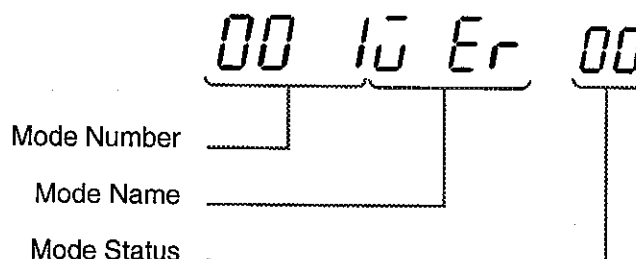

Number	Name	Description	Item	
			Item	Value
001	VER	Version display	00*	Version off
			01	Main version
			02	Main date
			03	Front version
			04	Mecha version
105	DOF	Digital output format	00*	IEC 958 Part 3 (AES/EBU)
			01	IEC 958 Part 2(S/PDIF)
106	AID	Auto ID	00*	Off
			01	On (REC key pressed)
			02	Auto (silence detection)
110	ETN	Error tone	00	Off
			01*	On
111	LCD	LCD contrast	00	Minimum
		
			07*	Maximum
201	AIL	Silence detection level	00	-20 dB
			01	-30 dB
			02*	-40 dB
			03	-55 dB
202	AIT	Silence detection duration	00	300 msec
			01	600 msec
			02*	900 msec
			03	1.2 sec
			04	1.5 sec
401	TCF	Time code frame	00*	Automatic
			01	Manual
403	STC	Still time code	00*	Not output
			00	Output
408	TCO	Time code out	00*	Tape
			01	Auto
801	MRS	Memory reset		

* Indicates the factory default for each parameter.

FOSTEX PD-4 DIGITAL AUDIO RECORDER

SETUP mode table of contents

You can see the table of contents of the SETUP mode. The following functions can be checked on this list:

- 100 series - 105, 106, and 110.
- 200 series - 201 and 202.
- 400 series - 401, 403, and 408.

How to access the SETUP mode table of contents

Turn the PD-4 off. Press and hold the LIGHT key (35) and turn the POWER switch ON. The SETUP indicator (55) on the display will be illuminated. While you continue to press the LIGHT key, the setting lists will be shown for the 100 series, 200 series, and 400 series. Each will be shown in turn for 0.5 seconds. When you release the LIGHT key, the display will return to normal.

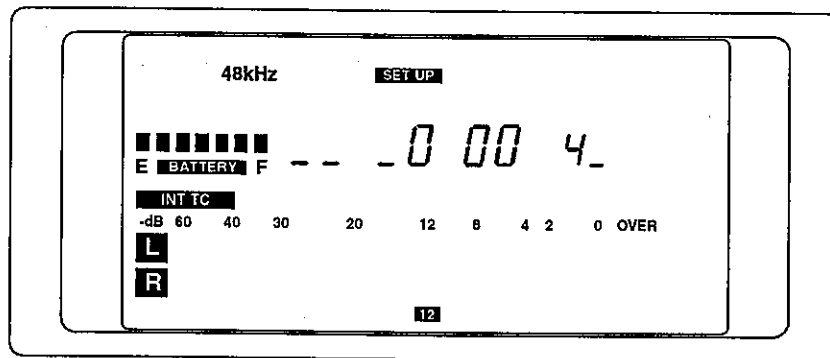
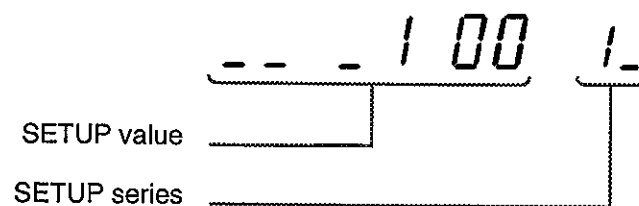

Figure 29
SETUP mode table of contents

Each digit of the SETUP value indicates the current setting of the individual SETUP functions.



Fostex PD-4 DIGITAL AUDIO RECORDER

Examples

100 series

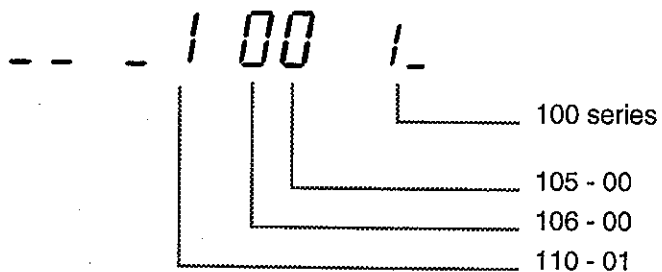

200 series

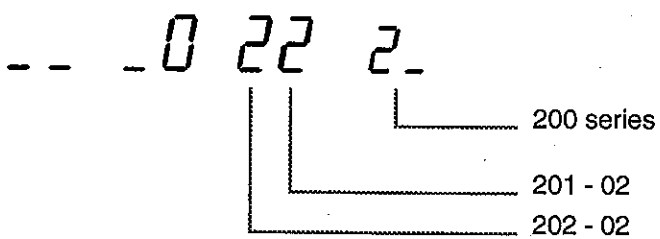

400 series

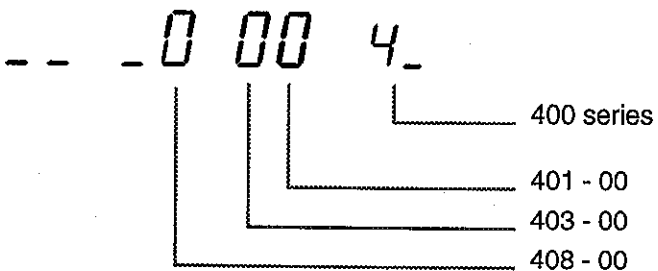

The above show the factory default settings.

Error messages

PCM ERR LED

The PCM ERR LED will illuminate under the following conditions:

1) Green illumination:

When the average value of BER (block or burst error rate) for C1 over eight (8) frames exceeds 1%. The LED will remain illuminated for about 8 frames (about 240ms).

The LED will remain illuminated under a continuous error.

2) Red illumination:

When the average value of BER for C1 over eight frames exceeds 10%. The LED will remain illuminated for about 8 frames (about 240ms).

The LED will remain illuminated under a continuous error.

PCM ERR indicator

The PCM ERR indicator on the LCD will illuminate when the average value of BER for C1 over eight frames exceeds 10%. The indicator will remain illuminated for about 8 frames (about 240ms).

The indicator will remain illuminated under a continuous error.

Audio muting

The audio outputs will be muted under the following conditions:

When the average value of BER for C1 over one frame (two tracks) exceeds 75%. The PCM ERR LED will remain illuminated for one frame (about 30ms).

Specifications

Input/output connector pin assignments

XLR wiring

The XLR type connectors are wired as shown:

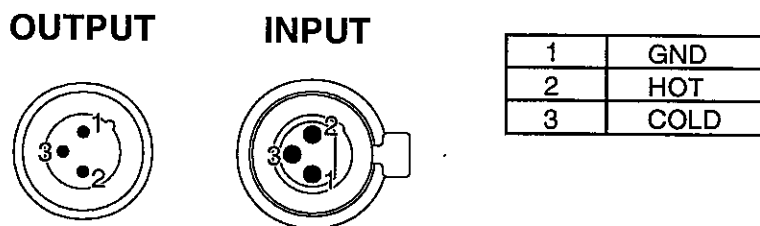

Figure 30
XLR wiring

To maintain signal phase integrity, always check the XLR wiring details of the equipment you are using.

When the PD-4 is connected to equipment with unbalanced inputs, use only the GND and HOT pins. Do not connect the unused COLD pin to the GND pin, as this will increase crosstalk and noise.

All the TC (timecode) connections are balanced. You should use three-core XLR type cables.

On the digital connections, there is no difference between the signal appearing at pin 2 and pin 3.

Headphone wiring

The stereo headphone connection is wired: CH1 - TIP and CH2 - RING.

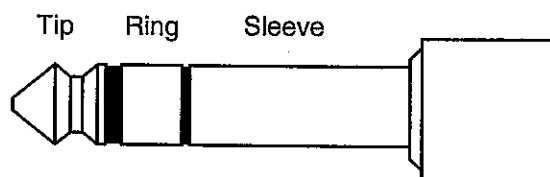

Figure 31
Headphone jack wiring

DC IN wiring

The XLR-4-32 type external power supply connector is wired as follows:

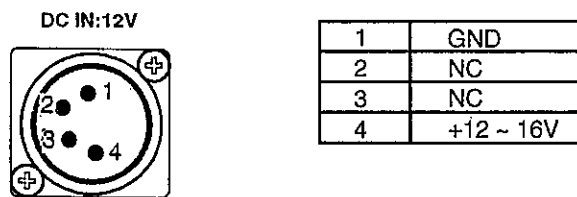

Figure 32
DC IN wiring

CAUTION: Connecting the power plug incorrectly or into an AC outlet with incorrect voltage may cause serious damage to the PD-4.

Fostex PD-4 DIGITAL AUDIO RECORDER

Technical specifications

General

Recording format	PRO DAT (IEC DAT standard part 5)
Tape used	Digital Audio Tape
Number of channels	Audio × 2 Timecode × 1
Recording time	120 minutes (using T-120 tape)
Cylinder head	Rotating 4-head, 30mm diameter
Error correction	Double Reed-Solomon encoding
Sampling frequency	48 kHz, 44.1 kHz, 48.048 kHz
Transmission rate	2.4 Mbit/sec
Emphasis	50 µsec / 15 µsec at playback only (auto)
Copy guard	None
Quantization	16-bit linear
Motors	2DD 1 mode motor
Power supply	NiCd battery: SONY NP-1B or equivalent
External power supply	AC adaptor, AD-15 (optional), DC 12V ~ 16V
Power consumption	13W at recording
Battery life	Approximately 2.5 hours (using NP-1B) Backup memory life: approximately 2 months
External dimensions	307(W) × 93(H) × 216(D) mm
Maximum dimensions	327(W) × 108(H) × 228(D) mm
Weight	3.2kg (without battery)

Mechanical

Tape speed	8.15mm/sec (±0.25%)
Fast forward time	Approximately 80 sec (using T-120 tape)
Search speed	100 × play speed

Electrical

Record/playback frequency response	20 Hz to 20 kHz ±0.5 dB
Signal-to-noise ratio	Better than 90 dB
Dynamic range	Greater than 90 dB
Total harmonic distortion	Less than 0.05% (1 kHz, standard recording level)
Channel separation	Better than 80 dB at 1 kHz
<i>Note: The five specifications above apply when the line input is used.</i>	
Wow and flutter	Lower than measurable limit (±0.002%, WTD/PEAK)
Standard recording level	Fixed at -12 dB (0 dB = 16 bit full scale level)
Meter display	
LCD	7 segments × 8 digits
Level indication	19 segments
Microphone filter characteristics	Frequency = 20 to 300 Hz continuous, -12 dB/octave
Microphone attenuator	20/0 dB

Connectors

Note: XLR connector: pin-1 = ground, pin-2 = hot, pin-3 = cold. Analog input/output standard level = +4dBu (0dBu = 0.775Vrms)

Analog audio input Connectors	XLR-3-31
----------------------------------	----------

FOSTEX PD-4 DIGITAL AUDIO RECORDER

Connectors

Microphone	
Standard input level	-60 dB(u)
Minimum input level	-70 dB(u)
Maximum input level	-28 dB(u)
Matching microphone impedance	Less than 600 Ω
Input impedance	Greater than 5 k Ω
Line	
Standard input level	+4 dB(u)
Minimum input level	-6 dB(u)
Maximum input level	+24 dB(u)
Input impedance	Greater than 20 k Ω
Analog audio output	
Connectors	XLR-3-32
Standard output level	+4 dB(u)
Maximum output level	+21 dB(u)
Matching load impedance	Greater than 600 Ω
Output impedance	Less than 200 Ω
Digital audio input	
Format	AES/EBU (IEC958 Part 3), S/PDIF (IEC 958 Part2) Automatic select
Connector	XLR-3-31
Digital audio output	
Format	AES/EBU (IEC958 Part 3), S/PDIF (IEC 958 Part2) User selection
Connector	XLR-3-32
Timecode input	
Format	SMPTE/EBU
Connector	XLR-3-31
Standard input	2V peak-to-peak
Minimum input level	0.25 V peak-to-peak
Input impedance	Greater than 20 k Ω
Timecode output	
Format	SMPTE/EBU
Connector	XLR-3-32
Standard output	2V peak-to-peak
Output impedance	Less than 1 k Ω
Matching load impedance	Greater than 600 Ω
Headphone output	
Connector	\varnothing 6.0mm stereo phone jack
Matching load impedance	Greater than 32 Ω
Maximum output	40 mW (32 Ω)

Fostex PD-4 DIGITAL AUDIO RECORDER

Dimensions

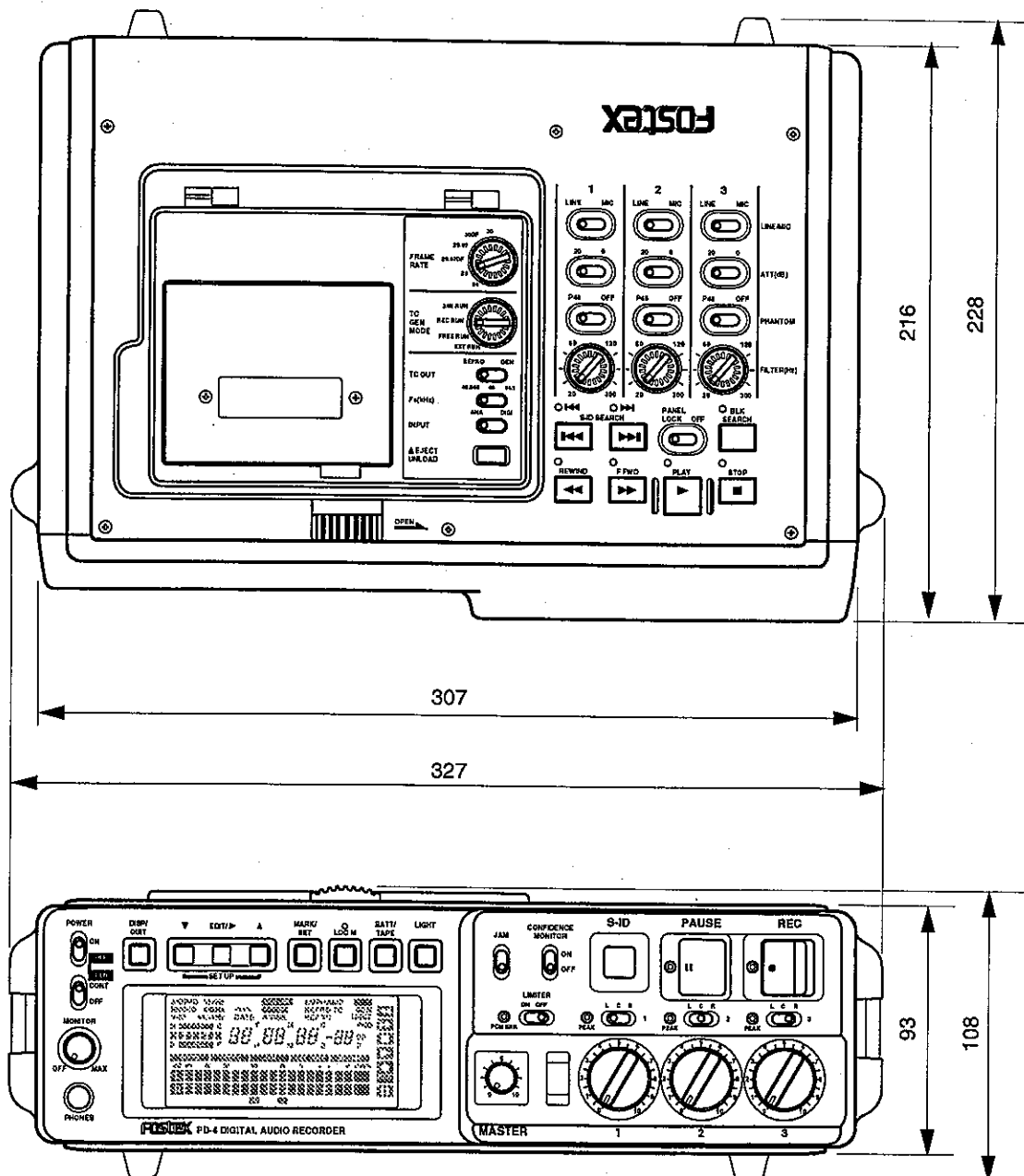

Glossary

1.5TP	The track pitch (20.4µm) when recording at 1.5× speed (wide track mode).
8-10 modulation	The modulation format used for all DAT recording. 8-10 modulation offers the following performance: <ol style="list-style-type: none">1) DC free.2) Spectrum is concentrated on the short wave side to maximize the azimuth effect.3) The ratio between the shortest wavelength and the longest wavelength is 1:3-4. There is no change in the S/N for overwrite.
A/D	Analog to digital signal conversion.
Aliasing noise	Noise generated when the frequency of the signal being digitized exceeds 1/2 of the sample frequency.
Analog	Continuously changing over time.
ATF	Auto Track Finding. The servo tracking system used for DAT.
Azimuth	The angle of the heads relative to the track.
Azimuth recording	A method of recording two adjacent tracks without a guard-band between them by setting the alternate heads at different angles. A head reading the other track will receive a highly attenuated signal due to phase cancellation.
BER	Block or burst error rate. The number of blocks of data in errors in a frame. An error rate of about 1% can be corrected by the error correction system. An error rate of about 8% can be concealed using interpolation techniques.
Bit	A single unit of digital data. It can have a value of 1 or 0.
Blank search	Searching for an area on tape that has not been recorded (no audio or subcode data) or for an END-ID marker.
Block	A single unit of PCM audio or subcode. 1 block = 288 bits.
BOT	Beginning of Tape. A special marker on the DAT cassette.
Burst error	An error of short duration.
C1	Parity check code, data name is P. Used by the Reed-Solomon error correction code.
C2	Parity check code, data name is Q.
Category code	The channel status bytes present in the AES/EBU interconnect standard. Options are professional or consumer.
Channel bit	A bit of data after being modulated.
Channel frequency	The maximum frequency of the signal recorded onto tape (4.704 MHz).
Crosstalk	The pick-up of unwanted signal from adjacent tape tracks. The ATF system measures the crosstalk from both channels to centre itself in the track.

Fostex PD-4 DIGITAL AUDIO RECORDER

D/A	Digital to analog signal conversion.
DAT cassette	Metal chrome tape (thickness 13 μ m, width 8.8mm).
Digital	Audio data represented in a numeric format.
Dropout	The loss of continuous signal due to attenuation or noise. Dropout can be caused by dirt on the tape or tape heads.
Drum	The record/playback head assembly. It consists of the drum motor, rotary transformer, upper drum (revolving), lower drum (fixed), and the mounting flange.
EOT	End of Tape. A special marker on the DAT cassette.
Erase signal	A 1.5 MHz signal that is used to erase the ATF area pilot and sync signal while re-recording.
Error correction	The detection and correction of digital signal errors. DAT employs a Reed-Solomon error correction code. errors can be caused by dirt, tape scratches, or electrical glitches.
Error rate	The number of errors detected in relation to the total volume of data. See BER.
Frame	The total data stored on tape from one complete rotation of the drum. 1 frame = 2 tracks, 30msec long.
Fs	See sample frequency.
Guard-bandless	A method of recording with no gap left between adjacent tracks. See azimuth recording.
Head	The component inside the upper drum that performs the electromagnetic conversion involved in reading or writing the DAT cassette. The track width is 20 μ m, azimuth angle is 20°, head tip is 2mm \times 2mm, and the gap mainly consists of sendust.
IBG (Inter Block Gap)	A space left between two data blocks.
ID hole	Recognition holes in the tape shell used to identify the type of DAT cassette.
Jitter	Fluctuations in the reference timing signal.
Overwrite	The recording of a new signal directly over an existing signal. Does not require an erase head.
P	Parity check code (C1).
Pack	The area of the subcode containing the time and date information.
PCM	Pulse Code Modulation. A scheme for encoding audio data as a series of pulses. Each pulse defines a transition from binary one to binary zero.
Pilot signal	A 130 kHz signal recorded on the DAT cassette that is used by the ATF system.
P-NO	Program number. The number allocated when a S-ID (start id) marker is recorded.
Quantization error	Noise present in digital audio due to inaccuracies in the A/D and D/A conversion. Some of these errors are unavoidable due to round-off and other fundamental limitations.
Rotary transformer	The transformer that is used to convey the signal between the upper drum and lower drum.

FOSTEX PD-4 DIGITAL AUDIO RECORDER

Sample frequency	The rate at which measurements of an audio signal are taken during A/D and D/A conversion. The measure is samples per second.
Subcode data	Data such as program number, index number, timing information, and other information.
Symbols	The 8-bit sub-unit of a 16-bit PCM word (sample).
Track pitch	The width of a track. 13.6 μ m for normal track mode.
Tracking servo	Capstan servo system that ensures the tape passes the drum at the required speed.
Wide track mode	See 1.5TP.
Word	One sample of audio data. 16 bits of PCM data.
Word clock	Used for synchronizing PCM audio signals. The word clock frequency will be the same as the sample frequency.
Wrap angle	The head area (drum) that is in contact with the tape. The DAT wrap angle is 90°.

Fostex

FOSTEX CORPORATION

3-2-35, Musashino, Akishima-shi, Tokyo, Japan 196-0021

FOSTEX AMERICA

15431, Blackburn Ave., Norwalk, CA 90650, U. S. A.

© PRINTED IN JAPAN APRIL 2001 8288 349 900 FX

Free Manuals Download Website

<http://myh66.com>

<http://usermanuals.us>

<http://www.somanuals.com>

<http://www.4manuals.cc>

<http://www.manual-lib.com>

<http://www.404manual.com>

<http://www.luxmanual.com>

<http://aubethermostatmanual.com>

Golf course search by state

<http://golfingnear.com>

Email search by domain

<http://emailbydomain.com>

Auto manuals search

<http://auto.somanuals.com>

TV manuals search

<http://tv.somanuals.com>